

Seating

Executive/Conference
Task
Specialty Task
Stools
Guest/Side
Bariatric/Patient
Beam/Tandem
Stacking/Nesting
Lounge
Impromptu

REFLECTS APRIL 1, 2017, PRICING

3

Price List
July 6, 2015

EFFECTIVE NOVEMBER 14, 2016

AD Almond and PB Portobello seating finishes are available on most wood chair series.

Exceptions: Fringe tables, Reno tables, Swift tables, and Jewel.

Acorn finish is no longer available on Fringe bistro table models.

National Office Furniture - Warranty

National warrants that each piece of furniture will be free from defects in workmanship given normal use and care for as long as you, the original customer, owns and uses the product.

Normal use is defined as the equivalent of a single shift, 40 hour work week. In the event that a product is used more than normal use, the applicable warranty period will be reduced to 12 years and items that fall under different warranty limitations, as listed below, will be reduced to one-third (ex: Wood chair frames will be 4 years instead of 12 years). National, at its option, will repair or replace with comparable product any product, part or component shipped after September 1, 2000, if the claim is eligible under the conditions of this warranty. This warranty is valid only if the product is given proper care and maintenance.

Limitations

Twelve Years	Wood Chair Frames
Ten Years	Seating Controls, Wood Veneers and Laminates
Five Years	Mechanical and High Wear Parts Such As: Electrical Components, Polymer Based Components, Pneumatic Cylinders, Swivel Arm Pads, Casters, Chair Glides, Textiles, Foam, Covering Materials and Decorative Trim

Exclusions

This warranty does not apply to:

- Damage caused by a carrier
- Normal wear and tear which is to be expected during the period of ownership
- Appearance, durability, quality, behavior, colorfastness or any other attribute of COM (Customer's Own Materials) or any other non-standard National material (including Arc-Com, CF Stinson, Maharam, Momentum, and Ultrafabrics) specified by the customer after application to a National product
- Color, grain or texture of wood, laminate and other covering materials
- Non-compliance with installation and maintenance instructions
- Electrical grommets where the box has been opened
- Damages or failures resulting from modifications, alterations, misuse, abuse or negligence or improper care and maintenance of our products

NOTE: A protective glass top is not recommended on tops greater than 72". A single piece of glass should cover a multi-piece top. A glass addition has the potential to accentuate deflection. If glass is applied, this will require a special quote to investigate the support needed.

Gotcha™ 24 Hour Use Seating

Warranty on Gotcha 24 Hour Use models is 5 years from date of purchase for seating controls and pneumatic cylinders and 2 years from date of purchase for casters, textiles and foam.

Finish Warranty

Minor variations in finish color may occur due to the unique texture and grain of wood.

Follow these procedures to process warranty issues:

1. Contact National Customer Service (800.482.1717) and provide them with the serial number from the product in question and the purchase order number or acknowledgement number and a detailed description of the warranty issue. **Serial numbers are mandatory before the claim can be processed.**
2. Customer Service will determine and pre-approve all resolutions to the claim such as replacement units, service parts, labor and repair charges. Upon approval, resolutions will be assigned an authorization number.
3. The authorization number must be included on all invoices for reimbursement. Any unauthorized charges will not be the responsibility of National.

As the manufacturer of your furniture, we stand behind our craftsmanship and pledge to do everything we can to resolve any problems you may have within the terms of this warranty as quickly as possible.

There are no other warranties except as expressly set forth here, either expressed or implied including any warranty of merchantability or fitness for any particular purpose. We exclude and will not pay consequential or incidental damages under this warranty.

National Office Furniture
1610 Royal Street
Jasper, Indiana 47549
800.482.1717
Fax 812.482.8800
www.NationalOfficeFurniture.com

GENERAL INFORMATION

Contact Information 4
 Ordering Procedures 4
 Changes and Cancellations 4
 Terms and Pricing 4
 Product Design 4
 Shipping/Freight 4
 Delivery 4
 Claim Process 5
 Quick Delivery Program 6
 Chair Features and Adjustments 7
 Sustainability Information 8
 BIFMA and ANSI Testing 10
 Life Cycle Management Program 12
 Finishes and Materials 12
 National Seating Upholstery 14
 Alliance Program Textiles 20
 Arc-Com 21
 Maharam 23
 Momentum 27
 Stinson 29
 Ultrafabrics 30
 COM and COL 32
 Power/Data Electrical 461
 National TB133 Pricing 465
 Alliance Program Pricing 495
 Alliance Program TB133 Pricing 568
 COM Yardage Requirements 637
 ACT Performance Icons 670
 Index 671

SEATING

Acquaint® 35
 Admire® 45
 Arlington™ 51
 Aurora® 57
 Cinch® 63
 Confide® 83
 Davari® 115
 Ditto™ 119
 Eloquence® 123
 Essay® 139
 Fringe® 147
 Fuel® 203
 Gotcha™ 219
 Jewel™ 233
 Jiminy® 239
 Lavoro™ 243
 Medalist™ 261
 Mix-it® 267
 Monterey™ 309
 Pennant™ 317
 Remedy® 323
 Reno® 329
 Respect® 355
 Result® 361
 Swift™ 365
 Tag® 391
 Timberlane™ 415
 Toss™ Accent Pillows 427
 Wedges and Cushions 432
 Triumph™ 437
 Wander™ 445
 Whimsy® 449

ADDENDUM

New Seating Upholsteries 2A
 Farrah™ 7A
 Grin™ 13A
 Kozmic™ 22A

Series	Task	Lounge	Guest/Stacking/ Nesting	Executive/ Conference	Stools	Tables	Beam/ Tandem	Bariatric/ Patient
Acquaint			•					•
Admire			•					
Arlington			•	•				
Aurora			•	•				
Cinch	•		•	•	•	•	•	
Confide		•	•			•	•	•
Davari			•					
Ditto			•		•			
Eloquence		•	•	•		•	•	•
Essay	•				•			
Fringe		•				•		
Fuel	•				•			•
Gotcha	•				•			
Jiminy			•					
Jewel			•		•			
Lavoro	•		•	•	•			
Medalist			•	•				
Mix-it	•		•	•	•			
Monterrey		•						
Pennant		•	•					
Remedy			•	•				
Reno		•				•		
Respect			•	•				
Result				•				
Swift		•				•		
Tag			•		•	•		•
Timberlane			•			•	•	•
Triumph			•	•		•		
Wander	•							
Whimsy			•					

General Information

Contact Information

National Office Furniture
1610 Royal Street
Jasper, Indiana 47549

To order literature, check order status, and check lead times on-line, please visit us at www.NationalOfficeFurniture.com.

Telephone: 800.482.1717
Fax: 812.482.8800
E-mail customer service: Service@NationalOfficeFurniture.com

Ordering Procedures

For prompt delivery, all orders **MUST** include:

1. Purchase Order Number (on each page of order)
2. Billing Address
3. "Ship To" Information
4. Special Shipping Instructions (requested ship or delivery dates, ship complete or split shipments, and tags if applicable)
5. Complete Model Numbers
6. Net Price

National does not accept orders verbally. Fax or e-mail orders directly to:

Fax: 812.482.8800
E-mail: Orders@NationalOfficeFurniture.com

(This e-mail requires an attached PDF order. General correspondence should go through Service@NationalOfficeFurniture.com.)

Order Confirmation

All complete orders will be acknowledged with ship dates **upon entry of a clean, credit approved order** into our system. This acknowledgement is the final agreement between National and the customer superseding all previous communications regarding the order.

NOTE: Please examine this acknowledgement carefully and advise National immediately of any discrepancies.

Changes and Cancellations

We regret that changes and cancellations are not possible once your order is entered into our system. In order to support our lead time commitments, orders are scheduled into our production cycle immediately upon order entry.

This includes changes/cancellations to:

- Quick Delivery Seating
- Made-to-Order Seating
- Engineered-to-Order (ETO) Seating
- Alliance Partner and COM Seating

Please contact customer service for assistance.

Terms and Pricing

- Prices are list prices for shipment within the continental United States.
- Price subject to change without prior notice.
- Merchandise will be billed at prices prevailing at time of placing order.
- Distribution of this price list does not itself constitute an offer to sell.
- Orders can be received only from authorized National Dealers.

Product Design

National reserves the right to make changes in design, specifications, and construction and to discontinue products without prior notice. Dimensions referenced in this book are nominal.

Shipping/Freight

All shipments are F.O.B. point of shipment, freight prepaid and allowed to one continental U.S. or one Canadian destination. International shipments and shipments into the states of Alaska and Hawaii are freight prepaid and allowed to port of exit.

Additional energy surcharges may apply.

National reserves the right to select the most appropriate F.O.B. point, carrier, and routing on all shipments.

Delivery Hours

Pricing is based on standard delivery between 8am and 3pm Monday through Friday.

Special Delivery Services

Any charges incurred from failure to receive a shipment, rerouting while in transit, or carrier storage charges are not included in prices shown and will be billed to the "sold to" account number on the order. Detention charges may be incurred for untimely off-loading of product.

Any order requiring **Special Delivery Services will incur additional charges.**

All such requirements must be noted on the purchase order. These are services that are not included in the price of the product or require the usage of specialized carriers. Examples of such Special Delivery services include:

- **Inside Delivery**
Minimum \$50 charge
- **Non-Standard Delivery Time (before 7:00am or after 5:00pm)**
Contact customer service for charges and availability
- **Non-Dock Delivery**
Minimum \$50 charge
- **JIT Delivery (specific day and/or time)**
Orders under \$10,000 list will incur a minimum \$125 charge
- **Weekend Delivery (Friday after 5:00pm until 7:00am Monday morning)**
Minimum \$500 charge per delivery
- **Residential Delivery**
Customer service may assist you in determining your special delivery requirement and any additional charges that may apply

Contact customer service if you are not sure if your order requires one or more of the above services. We will make every attempt to avoid the additional charges by giving options on what we can do within our standard delivery price.

Carrier Selection

National reserves the right to select the most appropriate mode of shipment. National relinquishes all responsibility for the goods shipped upon a clean receipt from the carrier. Customer bears the risk of loss or damage during shipment.

Packaging

National's standard method of shipping is to carton all items. Certain full truck load items may qualify for special consideration. Contact customer service for guidelines. International shipments can be crated at the customer's request. The expense of crating or specialized packaging will be the responsibility of the customer.

Loss, Damage, or Delay

National shall not be liable for loss, damage, detention, or delay resulting from causes beyond its reasonable control including but not limited to fire, strike, weather, wreck or delay in transportation. In the event of delay due to any such cause, the delivery date will be postponed by such length of time as may be reasonably necessary to compensate for the delay.

Claim Process for Merchandise Damage/Shortage/Carrier Delay

All the products produced by National are carefully inspected and properly cartoned prior to shipment. All shipments are delivered to the transportation company in good condition. If you receive a shipment that has damage, product shortage or delivery has been delayed by the transportation carrier, **the following steps must be taken:**

1. Before signing for merchandise, **make notation** of all visible damage, shortages, and/or time of truck arrival on the freight bill (bill of lading).
2. **Contact National Customer Service within 15 calendar days of goods receipt to report issue.** We will advise whether a freight claim will need to be filed based on the mode of transportation. Claims must be filed by dealer on Redistribution/LTL carrier shipments. Claim will be disputed if product is moved from original consignee location.
3. If claim must be filed, carrier must be contacted **within 15 calendar days of goods receipt.** Retain all shipping cartons for inspection by the carrier agent.
4. **Copy of Carrier Disposition Letter must be sent to National** to receive additional credit on concealed damage issues via Redistribution/LTL carrier shipments.

For Concealed Damage, follow steps 2 through 4.

Claim Process for Warranty Issues

If a warranty issue is discovered, contact customer service immediately. To file the warranty claim, the following information is required:

- Serial number and warranty number are **mandatory** (asset tag can be found under the seat)
- Dealer purchase order number or National acknowledgement number
- Detailed description of issue

Customer service must **pre-approve** all resolutions such as replacement units, service parts, labor and repair charges. We reserve the right to resolve the issue in the most cost effective manner. All approved resolutions will be assigned an authorization number which must be included on all replacement orders or invoices for reimbursement. Any unauthorized charge will not be the responsibility of National.

Please see the inside Front cover for a full description of our Lifetime Product Warranty.

Finish Warranty

Minor variations in finish color may occur due to the unique texture and grain of wood.

Finishes, when exposed to ultraviolet rays, may change color. These issues are not warranty defects and will not be the responsibility of National.

Return Merchandise

We discourage product returns due to the likelihood of damage during the return transportation. In the event a product return is necessary, we will make every attempt to help keep the product in the field. Please contact customer service for assistance.

If attempts to keep the product in the field are unsuccessful, National will allow **returns on stocking items only** with the following stipulations:

50% Restocking fee

Freight Charge prepaid by dealer

Product NEVER removed from original carton

Product must be returned within 30 days of RGA issue date

Credit will not be issued if product returned is damaged

Please note most models in the Quick Delivery Program are produced on demand and cannot be returned.

Freight damage, signs of usage or removal from original carton, or missing parts will result in no credit being issued. All returns require written authorization; any unauthorized return will not receive credit.

National will not be responsible for resolving damage claims on returned product.

Standard Modifications

Simple product modifications or "special products" are available. National Office Furniture offers product modifications, provided the change does not affect the form, fit or function of the current product (which may require additional testing). Product modifications are assigned a revised model number which references the standard model that includes a SIN code. A modest upcharge may be levied which can be based on product quantity ordered or other criteria. To confirm that a product modification will be handled as a contract item, please contact Government Customer Service at 800-482-1213.

Quick Delivery Program

Quick Delivery Program

Our most popular series and options are available to you on our “To You in 10 Days or Less” Quick Delivery program.



Need 20 chairs in 10 business days or less? No problem, with our Quick Delivery program, we've got you covered. Need more than 20? Just give us a call, and we'll work with you to get what you need, when you need it. Once in a while, demand exceeds capacity. Then, orders are subject to availability.

Specific models from the following series are available on Quick Delivery:

Acquaint	Fuel	Reno
Admire	Gotcha	Respect
Cinch	Jewel	Result
Confide	Jiminy	Tag
Davari	Lavoro	Timberlane
Ditto	Medalist	Triumph
Eloquence	Mix-it	Wander
Essay	Remedy	Whimsy

Quick Delivery Model Numbers

Quick Delivery seating models are available in all National finishes. The Quick Delivery model numbers are tagged with a “Q” and/or shaded in grey throughout the price list.

Quick Delivery Ordering

Orders may not be changed or cancelled. Include only Quick Delivery models on your order. Create a separate order for any products that are not included in the Quick Delivery program. Remember that 10 business days does not include weekends or holidays. The day your order is placed with National counts as day zero.

Large Quantity Ordering

Large quantities of models on an order, or large dollar volume orders, may receive lead times greater than those posted on www.NationalOfficeFurniture.com. Please work with your project management team to confirm availability on your specific project.

National chairs offer various levels of adjustability. The diagrams below help you to easily understand the many options available so you can select a chair that best fit your needs.

Adjustability Features

- A **Pneumatic Height Adjustment:** Allows the user to adjust the chair height quickly and easily.
- B **Back Height Adjustment:** Allows the user to position lumbar support for desired comfort.
- C **Seat Angle Adjustment:** Allows the user to position and lock the seat angle.
- D **Seat Depth Adjustment (Seatslide):** Allows the user to move the seat forward and back.
- E **Tilt Tension:** Allows the user to control the amount of recline resistance.
- F **Tilt Lock:** Allows the user to lock the back in upright position or release it to recline.

Controls

- G **Swivel Mechanism:** Chair swivels 360° only. Chair does not recline.
- H **Swivel Tilt Mechanism:** Chair swivels 360° and back and seat recline simultaneously.
- I **Knee Tilt Mechanism:** Chair swivels 360° and back and seat recline simultaneously. The pivot point is forward allowing user's feet to remain planted on the floor when reclining.
- J **Synchro-tilt Mechanism:** Chair swivels 360° and allows the back and seat to move in a synchronized 2.3:1 ratio motion.

Arm Options

- K **Fixed Arm**
- L **Adjustable Arms:** Arms can be adjusted in height and width to best fit the user.
- M **Fully Adjustable Arms:** Same adjustability as adjustable arms and also allows the arm pad to rotate.
- N **High Performance Arms:** Same adjustability as adjustable and fully adjustable arms but also has depth and width adjustment on the arm pad.

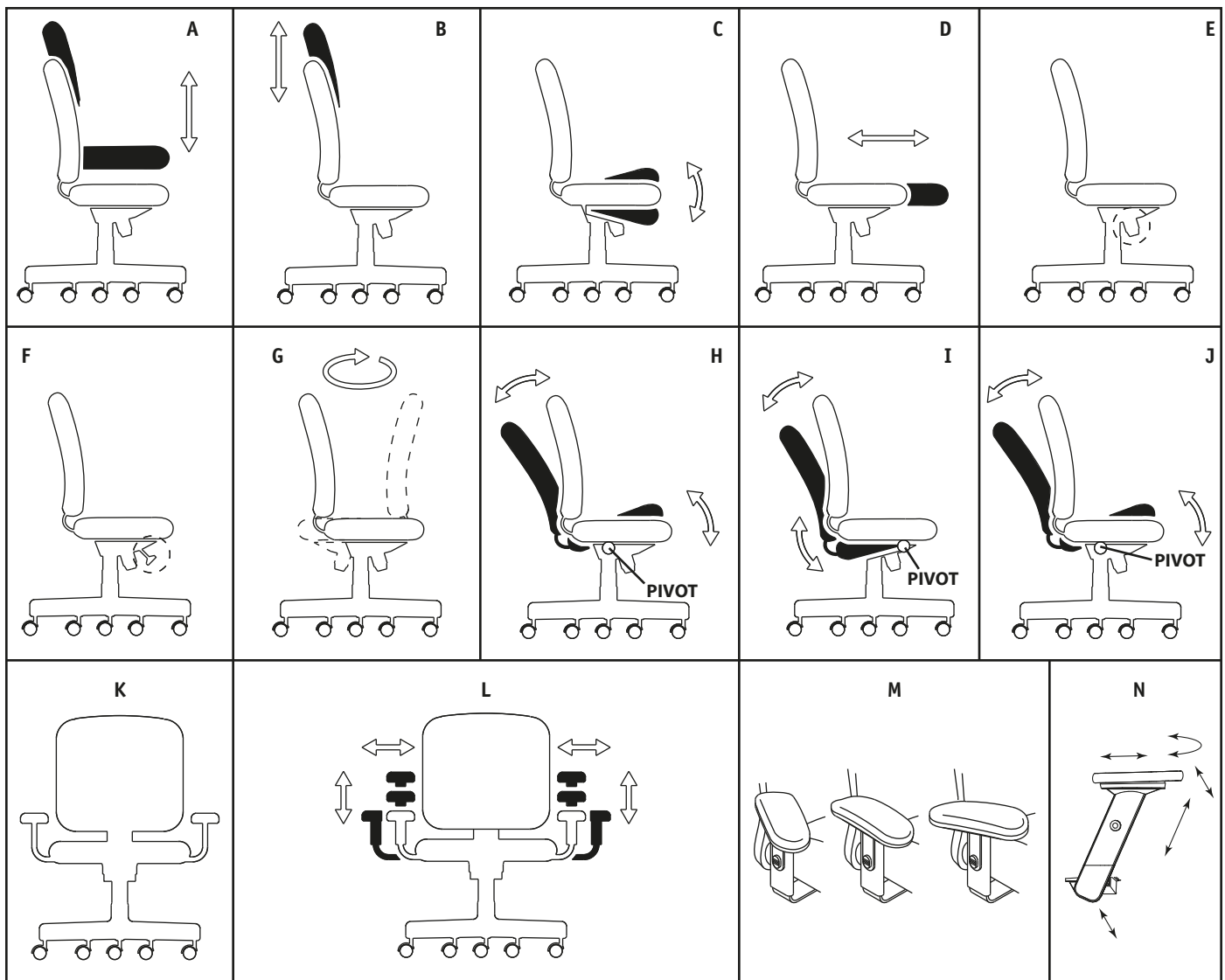

Sustainability Information

Our Statement on Sustainability

We aim to create lasting stakeholder value through responsible growth and deep commitment to the well-being of future generations. We cherish the Earth's natural resources and hold sustainability and environmental protection as our key priorities.

As our company fulfills its responsibilities to our customers, shareholders, employees and the public, six commitments provide a framework for focusing our energies toward the greatest good:

- Product Stewardship
- Environmental Preservation
- Green Building Development
- Regulatory Compliance
- Social Accountability
- Economic Responsibility

Our Products Reflect Stewardship

National is committed to providing quality products that will improve indoor air quality for the health of building occupants and visitors. Our products have achieved certification to the Indoor Advantage Gold label from Scientific Certification Systems (SCS) by meeting the BIFMA Furniture Emissions Standard (FES) for office furniture, and the California 01350 Special Environmental Requirements and Collaborative for High Performance Schools (CHPS).

In addition, virtually all National products carry the level® 2 or 3 label for meeting the far-reaching ANSI/BIFMA e3 Sustainability Standard. This standard addresses the areas of material and energy use, greenhouse gas impacts, human and eco-system health considerations, and social responsibility. Modeled after the LEED® building rating system, furniture products are evaluated against a variety of credit criteria (after first meeting certain prerequisites), accumulating points toward increasing levels of recognition associated with reduced environmental impact. Purchasing products certified to level® gives you the assurance that the product was produced in an environmentally and socially responsible manner.

National products that meet the above specifications are identified with corresponding logos throughout this price list.



In further support of our commitment to indoor air quality, National utilizes IntegraClear®, an environmentally-friendly, ultra-violet finish. IntegraClear® is a water-based, high-performance wood finish that meets or exceeds indoor air quality standards and is available on select products. This proprietary finish is virtually VOC-free, has remarkable durability and allows the natural beauty of veneers to show through.

National offers products that are not only economically viable, but are environmentally responsible and socially beneficial. An example of this is the option of Forest Stewardship Council (FSC) Certified wood (call for availability). Additionally, our casegoods include a recycled material content of at least 82 percent. A wide range of 100 percent recycled polyester choices are available for upholstered seating products while our casegoods packaging contains an average of 40 percent recycled content and our seating packaging contains an average of 37 percent recycled content. Our Corporate Recycling Center diverts over 4 million pounds of waste material per year from landfills by recycling 65 different types of materials.



What's more, National manufacturing facilities are registered to the ISO 14001 standard. This management tool enables us to identify and control the environmental impact of our operations, continually improve our company's environmental performance and systematically set environmental objectives and demonstrate their achievement.

We further support environmental improvements by shipping via our sister company, Kimball International Transit (KIT). KIT has earned certification in the SmartWaySM Transportation Partnership by the EPA. The SmartWaySM Transport Partnership is an innovative collaboration between the EPA and freight industry to increase energy efficiency while significantly reducing greenhouse gases and air pollution.

Growing With Green Buildings

National facilities testify to our belief in sustainable building practices. As a member of the U.S. Green Building Council (USGBC), we prioritize building practices that support the LEED® (Leadership in Energy and Environmental Design) Green Building Rating System.

LEED® Registered Projects

- Corporate Showroom**, Jasper, IN – LEED Gold
- Research and Development Rooms**, Jasper, IN – LEED Certified
- Showroom**, Atlanta, GA – LEED Pending
- Showroom**, Boston, MA – LEED Pending
- Showroom**, Chicago, IL – LEED Silver
- Showroom**, Dallas, TX – LEED Gold
- Showroom**, New York, NY – LEED Certified
- Showroom**, Washington, DC – LEED Silver
- Manufacturing Facility**, Santa Claus, IN – LEED Silver

Seating	Indoor Advantage Gold	level® 2	level® 3	FSC-Certified Option
Acquaint®	✓		✓	✓
Admire®	✓		✓	✓
Arlington™	✓	✓		✓
Aurora®	✓	✓		✓
Cinch®	✓	✓		
Confide®	✓		✓	✓
Davari®	✓		✓	✓
Ditto™	✓			
Eloquence® (Executive)	✓	✓		✓
Eloquence® (Guest, Tandem, Bariatric, Lounge)	✓		✓	✓
Essay®	✓	✓		
Fringe®	✓		✓	
Fuel®	✓	✓		✓
Gotcha™	✓	✓		
Jiminy®	✓	✓		
Lavoro™	✓			
Medalist™	✓	✓		✓
Mix-it®	✓	✓		
Monterrey™	✓		✓	✓
Pennant™	✓		✓	✓
Remedy®	✓	✓		✓
Reno®	✓		✓	✓
Respect®	✓	✓		✓
Swift™	✓		✓	
Tag®	✓	✓		✓
Timberlane™	✓		✓	
Triumph™	✓	✓		
Wander™	✓			
Whimsy®	✓		✓	

BIFMA and ANSI Testing

ANSI/BIFMA X5.1-2002 General Purpose Office Chair-Tests

The following tests were developed by the Business and Institutional Furniture Manufacturer's Association (BIFMA), and approved by the American National Standards Institute (ANSI). These performance tests determine the stamina of seating in its day to day use.

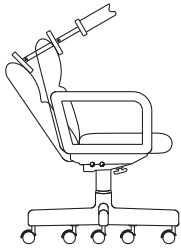

Backrest Strength Test: Type I - Back tilt chair, 200 lb. force applied, 300 lb. proof load. Type II & III - Back tilt chair, 150 lb. force applied, 250 lb. proof load.

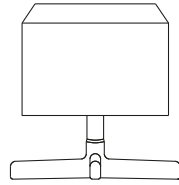

Base Test: Using 2500 lb. force for one minute, apply a second force of 2500 lb. load.

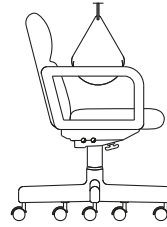

Drop Test: Using 225 lb. weight, 300 lb. proof load with 6" drop.

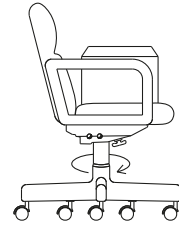

Swivel Cycle Test: 250 lb. on seat rotating base, 60,000 cycles at maximum height and 60,000 at lowest position.

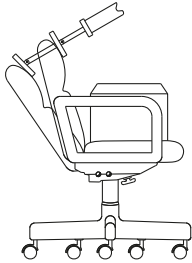

Tilt Mechanism Test: 300,000 tilts with 225 lb. in seat.

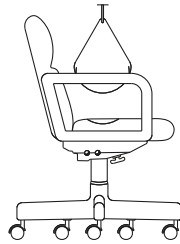

Seat Durability Tests: 125 lb. weight dropped onto seat 100,000 cycles.

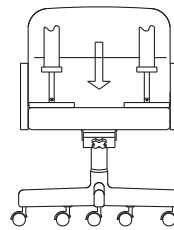

Front Load Ease: 165 lb. alternating for 40,000 cycles.

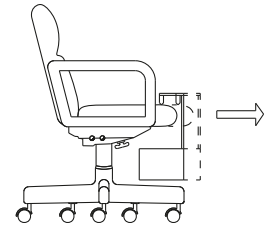

Front Stability Test: Apply 135 lb. on front edge of seat while applying horizontal 4.5 lb. force at top of seat.

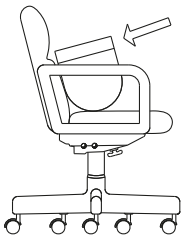

Rear Stability Test: Type I, II, and III with six 22 lb. disks with no less than 20.9 lb. of force should be required to tip chair back. Type I & II with 13 22 lb. disks chair shall not tip.

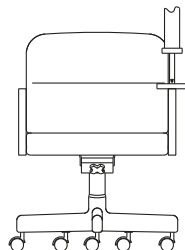

Arm Strength Test: 169 lb. force applied downward at arm's weakest point, 253 lb. proof load.

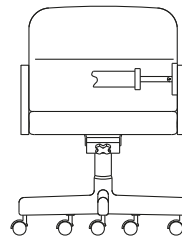

Arm Strength Test: 100 lb. force applied outward at arm's weakest point, 150 lb. proof load.

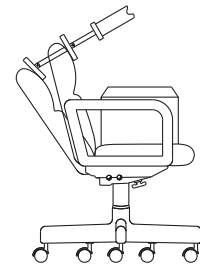

Backrest Durability Test: Type I - With 225 lb. on seat with chair fully reclined with 100 lb. force, 80,000 cycles. Type II & III - With 225 lb. on seat and tilting with 75 lb. force, 80,000 cycles. After 80,000 are complete 40,000 will be off center testing.

ANSI/BIFMA X5.1-2002 General Purpose Office Chair-Tests

The following tests were developed by the Business and Institutional Furniture Manufacturer's Association (BIFMA), and approved by the American National Standards Institute (ANSI). These performance tests determine the stamina of seating in its day to day use.

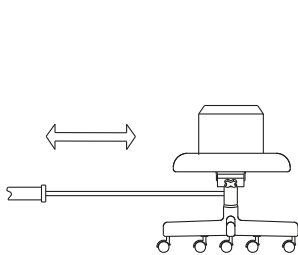

Caster/Chair Base Durability Test: 2,000 cycles over obstruction 98,000 over smooth along a 30" distance with a 250 lb. load.

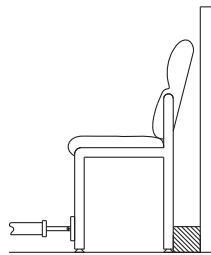

Leg Strength Test - Front Application: 75 lb. force applied, 113 lb. proof load.

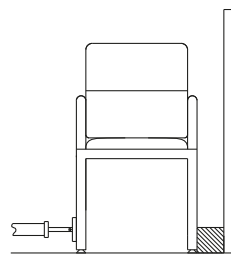

Leg Strength Test - Side Application: 75 lb. force applied, 113 lb. proof load.

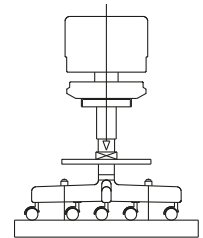

Footrest Durability Test: 100 lb. weight applied along a 4" length of the footrest for 1 minute.

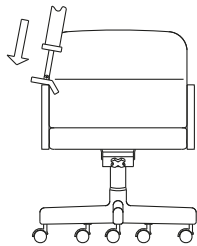

Arm Durability Test: Apply 90 lb. force at 10 degree angle for 60,000 cycles.

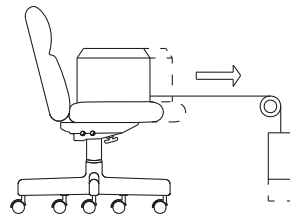

Out Stop Test for Chairs with Manually Adjustable Seat Depth: 163 lb. forward force with 55 lb. downward force for 25 cycles.

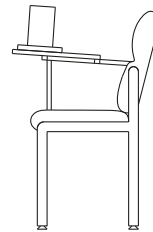

Tablet Arm Test - Static: 150 lb. load level for 1 minute.

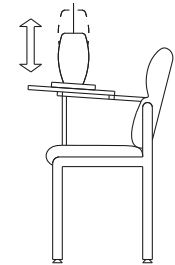

Tablet Arm Load Ease Test - Cyclic: 77 lb. dropped onto tablet center surface for 100,000 cycles.

- National seating also meets or exceeds the ANSI/BIFMA X6.1 Educational Seating.
- Testing does not serve as a warranty or guarantee. Generally, products within this price book meet or exceed the applicable BIFMA* and ANSI standards.

* National is a member of the Business and Institutional Furniture Manufacturer's Association.

General Information

Life Cycle Management Program

National offers a diverse collection of surface materials as well as a Life Cycle Management Program. This program includes our Discontinuation Policy to help make informed planning decisions.

Discontinuation Policy

National strives to give all business partners advanced notification of surface materials that are scheduled for deletion. Efforts will be made to support discontinued materials as specified in the deletion announcement. Extended lead times and minimum order requirements may apply. Pricing cannot be guaranteed.

Disclaimer

National will make every reasonable effort to maintain our commitments. If surface material changes must occur due to unforeseen circumstances, we will work with you on an alternative recommendation. National reserves the right to cancel or make changes to standard products and surface materials.

Wood Finish Color Matching

Each piece of natural veneer offers unique texture and grain. Minor variations in finish color and value may occur due to the natural characteristics of wood. National carefully selects all materials used in every product ensuring a commercially acceptable color and finish. Factors such as aging and exposure to light alter finishes.

Fabric Color Matching

National will always ship a satisfactory commercial match on fabric. Because of industry dye-lot variation, colors may not match exactly.

Fire Retardant Products

All National chairs currently meet California Technical Bulletin #117-2013. For California Technical Bulletin #133 requirements, contact customer service for lead times and pages 14-18 for applicable fabrics. TB133 pricing is found on pages 465-493.

Fabric listing for “no added” fire retardant fabrics can be found at www.nationalofficefurniture.com

Seating Finish and Thread

National’s seating finishes can withstand cleaning solutions that include bleach, hydrogen peroxide (Virox), alcohol (CaviWipes, hand sanitizers), quaternary ammonium compounds (Virex, Ecolab A-456 II, Lysol,) and phenols (Wex-cide) when they are used in accordance with the manufacturer’s label instructions.

National manufactured seating features sewing thread by Guardian with Microban® Antimicrobial Product Protection. Microban protection helps prevent the growth of bacteria that can cause stains and odors on the thread providing an added level of protection in seam crevices that are susceptible to microbe activity.

Cut Yardage Program

All National textiles and leathers are available on a cut yardage basis. Cut yardage must be ordered in full yards. List prices include freight.

Fabric Price Grade	US List Price Per Yard	
1	\$ 41	
2	\$ 63	
3	\$ 82	
4	\$ 109	
6	\$ 177	
7	\$ 222	
Leather Price Grade	US List Price Per Half Hide (25-28 sq ft)	US List Price Per Full Hide (50-57 sq ft)
L7	\$ 643	\$ 1318
L8	\$ 763	\$ 1570

How to specify cut yardage:

1. Model Number
 NOFUPHCUTYDG = seating fabric
 NOFLTHRRHIDE = leather (half hide)
 NOFLTHRFHIDE = leather (full hide)
2. Upholstery grade
3. Upholstery number



Crypton® is a textile that is stain, water, odor and bacteria resistant.

Each fiber of a Crypton® Fabric is encapsulated to resist stains and bacteria, and Crypton's® moisture barrier is integrated into the fabric, ensuring permanent protection.

Crypton® is engineered to be extremely easy to clean, allowing spots and spills to be easily removed. Crypton® Care Stain Removers make cleaning upholstery simple and easy.

Crypton® Super Fabrics have ultra-low or non-detectable emissions.

Source: www.cryptonfabric.com

Crypton® Cleaners www.cryptoncare.com



100% of the electricity used to make this product is matched by Green-e certified renewable energy certificates. www.green-e.org



- Reduces energy consumption and conserves petroleum-based resources by offsetting the need to produce virgin synthetic fibers, providing a reprieve for our environment.
- U Trust™ verification program ensures that Repreve recycled fibers are traceable, transparent and certifiably sustainable.
- Consistent yarn quality; adheres to Unifi's first-quality standards.
- Repreve supports environmental non-profit organizations through its "Repreve Gives Back" campaign.

Repreve is a trademark of Unifi, Inc. and is registered with the U.S. Patent and Trademark Office and with others.

U Trust is a trademark of Unifi, Inc.

www.repreve.com



SILVERGUARD® is a natural environmentally friendly bacteria-fighting defense to inhibit odor and stain causing bacteria, plus the SILVERGUARD® technology is EPA registered and FDA approved. SILVERGUARD® stays fresh and lasts long due to the proprietary manufacturing process which promotes a controlled release of antibacterial properties. It continues to provide its bacteria-fighting protection after repetitive cleanings. The elemental protection of silver in SILVERGUARD® is an antibacterial agent. It is safe and efficient in diminishing odors, promoting freshness, and extending the life cycle of a product by attacking bacteria and other destructive organisms.



Terratex is a registered trademark of True Textiles, Inc. and designates fabrics that are made from 100% recycled or compostable material using increasingly sustainable manufacturing practices to produce a high quality product that is recyclable at the end of its useful life.



Reduced environmental impact due to recycled content, improved manufacturing process, no backing, rapidly renewable materials, PVC-free and/or chrome-free.

National Seating Fabric Offering

Shaded patterns are available on Quick Delivery models

DISCONTINUED - 12/31/16

American Graffiti — Grade 1

100% Polyester
54" Wide
No Finish; Acrylic Backing
Repeat: 15" H x 7.5" V (Non-matched)
Cleaning Code: W
96,000 Double Rubs
Can specify to meet TB133

5304 Jeans	5318 Cruisin'	5379 Leather
5305 Honey Mustard	5336 Catsup	5392 Convertible
5312 Roller Skates	5375 Chrome	5395 Diner

Cali — Grade 1

79% Polyester, 21% Rayon
54" Wide
Teflon Finish; Polyester Backing
Repeat: None (Non-matched)
Cleaning Code: W
70,000 Double Rubs
Does not meet TB133

11601 Cactus	11605 Sunset	11609 Surf
11602 Beach	11606 Boardwalk	11610 Coast
11603 Sand	11607 Pier	11611 Boulder
11604 Desert	11608 Vineyard	

Plush — Grade 1

100% Polyester
54" Wide
Teflon Finish; Polyester Backing
Repeat: None (Non-matched)
Cleaning Code: W
100,000 Double Rubs
Can specify to meet TB133

11701 Moss	11704 Sable	11707 Suede
11702 Down	11705 Kringle	11708 Snuggle
11703 Willow	11706 Fur	11709 Velvet

Ridge — Grade 1

100% Polyester
54" Wide
Teflon Finish; Latex Backing
Repeat: None (Non-matched)
Cleaning Code: W
100,000 Double Rubs
Can specify to meet TB133

12001 Meadow	12005 Crimson	12009 Sea Breeze
12002 Shine	12006 Driftwood	12010 Midnight
12003 Sunset	12007 Peak	12011 Sand
12004 Fog	12008 Pebble	12012 Dune

~~Speedway — Grade 1~~

52% Polypropylene, 48% Pre-Consumer Recycled Polyester
54" Wide
BLOCKaide™ Finish; SBR Latex Backing
Repeat: 0.375" H x 0.5" V (Non-matched)
Cleaning Code: WS
45,000 Double Rubs
Can specify to meet TB133, however select models are restricted; please refer to the TB133 Fire Rated Pricing section for restrictions

10105 Pace Car	10137 Victory Lap	10175 Start Your Engines
10110 Checkered Flag	10140 Infield	
10120 Trophy	10150 Finish Line	10190 Winner's Circle

~~Stardust — Grade 1~~

54% Polyester; 46% Repreve® Polyester (30% Pre-Consumer/16% Post-Consumer blend)
54" Wide
No Finish; Acrylic Backing
Repeat: 5" H x 4.35" V (Non-matched)
Cleaning Code: W
30,000 Double Rubs
Can specify to meet TB133



10501 Lynx	10504 Hydra	10507 Pavo
10502 Crux	10505 Carina	10508 Vela
10503 Draco	10506 Mensa	10509 Ara

~~Cathedral — Grade 2~~

100% Polyester
54" Wide
No Finish; Acrylic Backing
Repeat: 0.375" H x 0.875" V (Non-matched)
Cleaning Code: W
70,000 Double Rubs
Can specify to meet TB133

3906 Chartres	3917 Stonehenge	3936 Derby
3907 Florence	3924 Belgrade	3982 Wells
3911 Westminster		

COM — Grade 2

Orbit — Grade 2

100% Polyester
54" Wide
Teflon Finish; Acrylic Backing
Repeat: 7" H x 6" V (Matched)
Cleaning Code: W
40,000 Double Rubs
Can specify to meet TB133

20401 Galaxy	20404 Moon	20407 Comet
20402 Nebula	20405 Star	20408 Asteroid
20403 Nova	20406 Planet	20409 Cosmic

~~Pixie — Grade 2~~

100% Polyurethane
i-clean™ and Antimicrobial Finish; 85% Polyester, 15% Cotton Backing
Repeat: None (Non-Matched)
Cleaning Code: Use a soft cloth or sponge with mild soap and water to remove most soil and stains. See swatch card for additional cleaning info.
200,000 Double Rubs
Does not meet TB133

20201 Lime	20206 Chocolate	20211 Malt
20202 Honey	20207 Blackberry	20212 Licorice
20203 Orange	20208 Vanilla	20213 Root Beer
20204 Caramel	20209 Blue Raspberry	
20205 Cinnamon	20210 Blueberry	

DISCONTINUED - 12/31/16

Shaded patterns are available on Quick Delivery models

Sedona — Grade 2

100% Vinyl
54" Wide
Napa Topcoat Finish: 100% Polyester Hi-Loft™ Backing
Repeat: None (Non-matched)
Antifungal/Antibacterial
Cleaning Code: Use a soft cloth or sponge with mild soap and water to remove most soil and stains. See swatch card for additional cleaning info.
100,000 Double Rubs
Can specify to meet TB133, however select models are restricted; please refer to the TB133 Fire Rated Pricing section for restrictions

22101 Cactus	22141 Sand	22157 Horizon
22115 Tumbleweed	22142 Terra Cotta	22159 Desert
22123 Sierra	22143 Earth	22162 Indigo
22125 Yucca	22145 Buckskin	22166 Sagebrush
22126 Poppy	22147 Mesa	22177 Canyon
22129 Mirage	22151 Plateau	22185 Nighthawk
22131 Adobe		

Shenanigans — Grade 2

67% Pre-Consumer Recycled Polyester, 33% Nylon
54" Wide
BLOCKaide™ Finish; SBR Latex Backing
Repeat: 4.5" H x 4.5" V (Non-matched)
Cleaning Code: WS
50,000 Double Rubs
Can specify to meet TB133

20300 Gimmick	20344 Wile	20373 Ruse
20301 Antics	20352 Lark	20380 Tom Foolery
20317 Monkey Shine	20360 Maneuver	20389 Frolic
20322 Caper	20364 Stunt	20399 Mischievous

Spectrum — Grade 2

100% Pre-Consumer Recycled Polyester
54" Wide
BLOCKaide™ Finish; SBR Latex Backing
Repeat: None (Non-matched)
Cleaning Code: WS
100,000 Double Rubs
Can specify to meet TB133

20001 Mimosa	20039 Cornflower	20072 Breeze
20003 Lime	20040 Ruby	20079 Tangerine
20011 Sand	20045 Chocolate	20081 Charcoal
20015 Marigold	20050 Camel	20084 Royal
20020 Black	20062 Grey	20095 Red
20022 Burgundy	20067 Navy	
20033 Pine	20069 Grape	

Strand — Grade 2

100% Polyester
54" Wide
No Finish; Acrylic Backing
Repeat: 15" H x 5" V (Non-matched)
Cleaning Code: W
40,000 Double Rubs
Can specify to meet TB133

20101 Charcoal	20105 Red Licorice	20109 Cumulus
20102 Mineral	20106 Wheat	20110 Coast
20103 Fudge	20107 Peacock	20111 Sand
20104 Blueberry	20108 Blaze	20112 Stone

Tranquility — Grade 2

100% Pre-Consumer Recycled Polyester
54" Wide
BLOCKaide™ Finish; SBR Latex Backing
Repeat: 3.375" H x 2.4375" V (Non-matched)
Cleaning Code: WS
50,000 Double Rubs
Can specify to meet TB133

21302 Crackling Fire	21341 Subtle	21379 Shadow
21305 Flax	21354 Whisper	21386 Sonatas
21325 Poetry	21357 Bath	21398 Wisteria
21334 Hush	21361 Meadow	

Twilight — Grade 2

100% Pre-Consumer Recycled Polyester
54" Wide
BLOCKaide™ Finish; No Backing
Repeat: None (Non-matched)
Cleaning Code: WS
50,000 Double Rubs
Can specify to meet TB133



23101 Ocean	23109 Barley	23115 Fresh
23103 Nightshadow	23110 Espresso	23116 Cinder
23104 Gaze	23111 Bronze	23117 Vapor
23105 Goldrush	23112 Chartreuse	23118 Gingerbread
23106 Saucy	23113 Luxe	23119 Tangerine
23107 Aristocrat	23114 Willow	23120 Nude
23108 Rust		

Boardwalk — Grade 3

100% Pre-Consumer Recycled Polyester
54" Wide
BLOCKaide™ Finish; SBR Latex Backing
Repeat: 5" V (Non-matched)
Cleaning Code: WS
30,000 Double Rubs
Can specify to meet TB133
This pattern is railroaded, stripes run vertically

30501 Boulevard	30504 Track	30507 Aisle
30502 Avenue	30505 Alley	30508 Lane
30503 Footpath	30506 Trail	30509 Gateway

COL — Grade 3

Jacks — Grade 3

100% Eco Intelligent® Polyester
54" Wide
Soil and Stain Repellent Finish; No Backing
Repeat: 7.18" H x 5.15" V (Non-matched)
Cleaning Code: WS
100,000 Double Rubs
Can specify to meet TB133

30701 Beanstalk	30705 Sprat	30709 Frost
30702 Flash	30706 Russell	30710 In The Box
30703 Olantern	30707 And Jill	
30704 Pot	30708 Be Nimble	

National Seating Fabric Offering

Shaded patterns are available on Quick Delivery models

Pop Rocks — Grade 3

100% Eco Intelligent® Polyester
54" Wide
Soil and Stain Repellant Finish; No Backing
Repeat: 1.2" H x 1.9" V (Non-matched)
Cleaning Code: WS
100,000 Double Rubs
Can specify to meet TB133

31301 Green Apple	31305 Strawberry	31309 Wild Berry
31302 Lemon	31306 Milk Chocolate	31310 Blue Razz
31303 Pumpkin Patch	31307 Cola	31311 Cream Soda
31304 Cherry	31308 Malt	31312 Caramel

Big City — Grade 4

50% Pre-Consumer Recycled Solution Dyed Nylon, 50% Solution Dyed Nylon
54" Wide
BLOCKaide™ Finish, Acrylic Backing
Repeat: 14.2" H x 8.7" V (Non-matched)
Cleaning Code: WS, 4:1 Bleach Solution
100,000 Double Rubs
Can specify to meet TB133

40901 Dublin	40904 Rome	40907 NYC
40902 Istanbul	40905 Sydney	40908 London
40903 Barcelona	40906 Tokyo	40909 Amsterdam

Bumble — Grade 4

65% Pre-Consumer Recycled Polyester,
35% Post-Consumer Recycled Polyester
54" Wide
BLOCKaide™ Finish; No Backing
Repeat: 0.75" H x 1.1" V (Matched)
Cleaning Code: WS
75,000 Double Rubs
Can specify to meet TB133



41501 Pollen	41505 Honeycomb	41509 Scout
41502 Bee	41506 Hive	41510 Sting
41503 Nectar	41507 Swarm	41511 Worker
41504 Wax	41508 Queen	

Connect Four — Grade 4

100% Vinyl
54" Wide
PERMABLOK³® Finish; 100% Recycled
Hi-Loft™ Backing
Repeat: 18" H x 18" V (Non-matched)
SILVERGUARD® Silver Ion Technology
Antifungal/Antibacterial
Cleaning Code: Use a soft cloth or sponge with mild soap and water to remove most soil and stains. See swatch card for additional cleaning info.
100,000 Double Rubs
Can specify to meet TB133, however select models are restricted; please refer to the TB133 Fire Rated Pricing section for restrictions



42401 Lime	42404 Snickerdoodle	42407 Silver Dollar
42402 Butterscotch	42405 Penny	42408 Sea Glass
42403 Clementine	42406 Coffee Bean	42409 Blueberry

Echo — Grade 4

100% Pre-Consumer Recycled Polyester
54" Wide
Polyester Binder Finish; No Backing
Repeat: 6.75" H x 11.25" V (Non-matched)
Cleaning Code: WS
100,000 Double Rubs
Can specify to meet TB133



41101 Natural	41106 Seaport	41111 Cabochon
41102 Gold	41107 Limestone	41112 Cedar
41103 Russet	41108 Crystal	41114 Henna
41104 Lichen	41109 Oxide	
41105 Jute	41110 Peppercorn	

Silvertex™ — Grade 4

100% Vinyl
54" Wide
PERMABLOK³® Finish; 100% Polyester
Hi-Loft™ Backing
Repeat: None (Non-matched)
SILVERGUARD® Silver Ion Technology
Antifungal/Antibacterial
Cleaning Code: Use a soft cloth or sponge with mild soap and water to remove most soil and stains. See swatch card for additional cleaning info.
100,000 Double Rubs
Can specify to meet TB133, however select models are restricted; please refer to the TB133 Fire Rated Pricing section for restrictions



41301 Basil	41310 Sapphire	41318 Borscht
41302 Ice	41311 Champagne	41319 Lagoon
41303 Mandarin	41312 Celery	41320 Turquoise
41304 Raspberry	41313 Meteor	41321 Marine Blue
41305 Sunkist	41314 Cream	41322 Umber
41306 Mocha	41315 Chestnut	41323 Blackberry
41307 Carbon	41316 Luggage	41324 Sage
41308 Jet	41317 Taupe	41325 Bottle
41309 Storm		

Essence/Ultraleather™ — Grade 6

100% Polyurethane
54" Wide
No Finish; 100% Reinforced Rayon Backing
Repeat: None (Non-matched)
Cleaning Code: WS
400,000 Double Rubs
Can specify to meet TB133, however select models are restricted; please refer to the TB133 Fire Rated Pricing section for restrictions

3611 Light Oyster	3628 Midnight Metallic	3667 Taupe
3612 Red	3636 Chamois	3679 Raven
3613 Wheat	3640 Garnet	3683 Pecan
3614 Stone	3647 Loden	3690 Papyrus
3615 Dove Grey	3651 Green Tea Metallic	3692 Admiral
3617 White	3663 Walnut	

Shaded patterns are available on Quick Delivery models

Flock — Grade 6

100% Eco Intelligent® Wool
54" Wide
No Finish; No Backing
Repeat: None
Cleaning Code: WS
40,000 Cycles
Can specify to meet TB133

60400 Meadow	60405 Lasso	60410 Straw
60401 Sun	60406 Black Sheep	60411 Heather Cloud
60402 Bonfire	60407 Heather Gravel	60412 Heather Gunmetal
60403 Barn	60408 Sky	
60404 Apple	60409 Pond	

Scribe — Grade 6

65% Pre-Consumer Recycled Polyester;
35% Post-Consumer Recycled Polyester
56" Wide
Crypton® Green Finish; Moisture Barrier; Antimicrobial
Repeat: None (Non-matched)
Cleaning Code: W, 10:1 Bleach Solution or Crypton® Cleaners
210,000 Double Rubs
Can specify to meet TB133, however select models are restricted; please refer to the TB133 Fire Rated Pricing section for restrictions



60201 Juniper	60204 Chianti	60207 Alloy
60202 Pool	60205 Atlantis	
60203 Flicker	60206 Nutmeg	

Brisa® — Grade 7

100% Polyurethane
54" Wide
No Finish; 100% Reinforced Rayon Backing
Repeat: None (Non-matched)
Cleaning Code: WS
200,000 Double Rubs
Can specify to meet TB133, however select models are restricted; please refer to the TB133 Fire Rated Pricing section for restrictions

71001 Black Onyx	71006 Celery	71013 Canyon
71002 Cambridge Blue	71007 Bark	71014 Aztec
71003 Salsa	71008 Truffle	71015 Cabernet
71004 Abyss	71011 Desert Clay	
71005 Ash	71012 Sterling Blue	

Brisa® Distressed — Grade 7

100% Polyurethane
54" Wide
No Finish; 100% Reinforced Rayon Backing
Repeat: None (Non-matched)
Cleaning Code: WS
200,000 Double Rubs
Can specify to meet TB133, however select models are restricted; please refer to the TB133 Fire Rated Pricing section for restrictions

72001 Buckskin	72003 Lasso	72006 Manila
72002 Prairie	72005 Iron	72007 Moccasin

Promessa® — Grade 7

100% Polyurethane
54" Wide
No Finish; 65% Polyester, 35% Rayon Backing
Antimicrobial
Repeat: None (Non-matched)
Cleaning Code: WS
400,000 Double Rubs
Can specify to meet TB133, however select models are restricted; please refer to the TB133 Fire Rated Pricing section for restrictions

73001 Briarwood	73005 Bronze	73010 Tudor
73002 Horsehair	73006 Atlantic	73012 Woodpecker
73003 Linen	73007 Aquamarine	73016 Fields
73004 Parchment	73008 Shale	

Silica™ — Grade 7

100% Silicone
54" Wide
No Finish; Polyester Backing
Repeat: None (Non-matched)
Cleaning Code: W or 4:1 Bleach Solution
365,000 Double Rubs
Can specify to meet TB133

70901 Appletini	70908 Skyward	70915 Quartz
70902 Medal	70909 Cumulus	70916 Brownstone
70903 Marigold	70910 Gallant	70917 Alloy
70904 Garnet	70911 Dewpoint	70918 Glade
70905 Bistro	70912 Ginger	70919 Haze
70906 Terra	70913 Coppercrest	70920 Tropic
70907 Nero	70914 Burnished	70921 Herbal

Davenport — Grade L7

100% Leather
Top grain leather
Can specify to meet TB133

70101 Chamois	70108 Celadon	70114 Tomato
70102 Camel	70109 Austin	70115 Black
70103 Earthy	70110 Olive	70116 Plum
70105 Bark	70111 Brown	70117 Smoke
70106 Fennel	70112 Atlantis	70118 Dusk
70107 Glass Block	70113 Yonder	

Showcase — Grade L8

100% Leather
Chrome free full grain leather
Can specify to meet TB133

80101 Sky	80105 Greige	80109 Bittersweet
80102 Butler	80106 Power	80110 Jet
80103 Cream	80107 Garnet	
80104 Bonton	80108 Chestnut	

National Seating Fabric Offering

Cleaning Fabrics:

Cleaning Code S

- Use only mild, pure water-free cleaning solvents.
- Cleaning by a professional furniture service is recommended.

Cleaning Code WS

- Use water-based cleaning agents or foam. Mild water-free solvents may also be used.
- Cleaning by a professional furniture service is recommended.

Cleaning Code W

- Use water-based cleaning agents or foam.
- Cleaning by a professional furniture service is recommended.

Crypton® Cleaners

- Cleaning solutions for Crypton® fabric maintenance available at www.cryptoncare.com

Cleaning Leather:

Regular Cleaning

- Remove as much soil or staining as possible by carefully vacuuming or brushing.
- Dust with a dry or damp cloth.

Deep Cleaning

- Use mild non-detergent soap or cleaner. Wipe surface with a light circular motion. Repeat with clean water.
- Do not soak leather.
- Pat dry.
- Reference leather card for more information.

Fabric Characteristics

Different fabrics/constructions will respond better than others to specific seating applications. Certain fabrics/constructions are more prone to relaxing over time and can demonstrate characteristics such as wrinkling, pilling, fuzzing and puddling. Some upholsteries may experience dye transfer (clothing dyes transfer to the seating fabric). This does not mean that the fabric or application is deficient, but rather it is an inherent characteristic of that fabric or application and is considered normal behavior.

Leather Characteristics

Leather is a natural product. Healed scars, scratches, cuts and stretch marks are natural markings and are characteristics of leather. Leather may experience dye transfer (clothing dyes transfer to the leather). This does not mean that the leather or application is deficient, but rather it is an inherent characteristic of that leather or application and is considered normal behavior.

Textile Application Guidelines

National has listed textile application guidelines for each seating series. These guidelines are intended to help educate you of certain fabric characteristics. **Please make a point to review these guidelines when ordering National seating with National fabrics.** Application of the upholstery will be depicted as on the swatch card unless otherwise instructed on the order.

National Seating Fabrics

Pattern	Grade	Fabric Guidelines	Restrictions
American Graffiti	1	none	
Big City	4	3	
Boardwalk	3	1	All Mix-it except mesh back models; Aurora executive models
Brisa®	7	none	
Brisa® Distressed	7	none	
Bumble	4	2	
Cali	1	none	
Cathedral	2	none	
Connect Four	4	1	
Davenport	L7	none	
Echo	4	none	
Essence/Ultraleather™	6	none	
Flock	6	3	
Jacks	3	none	
Orbit	2	2	
Pixie	2	none	
Plush	1	none	
Pop Rocks	3	none	
Promessa®	7	none	
Ridge	1	none	
Scribe	6	1	
Sedona	2	1	
Shenanigans	2	1	
Showcase	L8	none	
Silica™	7	none	
Silvertex™	4	1	
Spectrum	2	none	
Speedway	1	none	
Stardust	1	none	
Strand	2	none	Fuel, Gotcha and Mix-it upholstered back models
Tranquility	2	none	
Twilight	2	none	

Textile Appearance Guidelines

Please note that these guidelines are here to help you have the best looking product that National can provide to you. Guidelines 1–4 are simply explanations of what you may see on your chair. We can still upholster fabrics associated with these guidelines, but you may see some of the characteristics described.

- 1 Due to thickness and or stiffness this textile may result in gathers and puckers around corners, contours and certain seams.
- 2 Patterns are considered matched directional; however, decorative stitching, tufting/buttons, seams and seat to back on corner, wedge and diagonal units may not align due to pattern configuration.
- 3 Textile with high nylon or wool content (more than 50%) may show signs of material stretch and lack of rebound when room temperatures fluctuate.
- 4 Mohair, velvet and chenille may be easily bruised or have the potential of crooked seams due to the heavy nap and flip.

Textile Restriction Guidelines

Fabrics associated with guidelines 5 and 6 prevent us from upholstering the applicable chair series.

- 5 This textile cannot be used for glue application. Potential issues could include poor adhesion quality to the mating surface, separation of the fabric face from the backing or glue bleeding through the fabric.
- 6 Thin and/or loosely woven textiles cannot be used due to potential fabric separation at the seams.

Alliance Program Textiles

Alliance Program Overview

National has developed joint programs with Arc-Com, Maharam, Momentum, Stinson and Ultrafabrics to offer you quality office seating with exciting lines of designer upholsteries. This program enables you to issue just one purchase order, providing simplified ordering and the most convenient, yet complete, seating choices available from a single source. All Alliance patterns meet TB117-2013.

Fabric listing for “no added” fire retardant fabrics can be found at www.nationalofficefurniture.com

Application

Application of the Alliance Program upholstery will be depicted as on the memo sample or website. If a different application is desired the pattern will need to be custom quoted.

Directional upholstery, such as stripes, patterns, and plaids may not be suitable for chairs with contoured shapes, tufting, or decorative stitching. Every effort is made to upholster all chairs as expertly as possible; however such orders are not subject to return.

Fabric that requires non-stock special treatments such as flame proofing, anti-microbial treatment, electrical conductive backing, water repellent, stain repellent, or acrylic backing are not part of this program. Such orders should be specified as COM.

Lead Times/Availability

Models specified with Alliance Program fabrics will be acknowledged at standard lead times based on the supplier’s delivery schedule. Exceptions may occur when extended lead times apply. Each supplier reserves the right to discontinue patterns and colors. National will not be held responsible for suppliers discontinuing patterns/colors or when minimum order quantities apply. Contact customer service for availability before finalizing orders.

Warranty

Alliance Program fabrics are non-standard materials and are **not** covered under our warranty.

Pricing

Alliance Program graded pricing includes the cost of material. Repeat is also accounted for and no additional upcharge is required.

Fabric and Seating Construction

Different fabrics and seating constructions will respond better than others to specific seating applications. Certain fabric constructions are more prone to relaxing over time and may demonstrate characteristics such as wrinkling, pilling, fuzzing, or puddling. Some upholsteries may experience dye transfer (clothing dyes transfer to the seating fabric.) This does not indicate that the fabric or application is deficient, but rather it is an inherent characteristic of that fabric or application and is considered normal behavior.

Important: The information provided was the most current information available at the time this price list was printed. Contact customer service for availability before finalizing orders.

TB133

California Technical Bulletin No. 133 – Flammability test procedure for seating furniture used in public occupancies. National provides pre-approval for TB133 chair/alliance fabric combinations. The availability of TB133 on specific chair/alliance fabric combinations can be found at www.NationalOfficeFurniture.com/alliance. Each of the graded-in listings denote TB133 applicability. Even though we try to keep this document as accurate as possible, the supplier may change contents, finishes, etc... without our knowledge. Customer needs to confirm that the information on this listing matches the content information from the Alliance partner. If no test data is available for a particular fabric/chair combination, the TB133 order will not be allowed. These pre-approved alliance fabrics can be ordered as standard product – no custom quote required.

To order seating to meeting the TB133 fire code, specify an “F” at the end of the model number (Ex: N59AAF).

If a fabric/chair combination has not been burn tested, the customer has the option of having it tested. Pricing for the testing will be \$1300 list, including shipping for testing services plus the chair price (test sample). TB133 testing requested by the customer will require a custom quote. The fabric/chair burn test results will determine whether future orders can be ordered as standard product or custom quotes. Each instance may vary.

TB133 alliance list pricing can be found on pages 568-635.

Letters of assurance are available upon request. A letter of assurance verifies that a TB133 test was conducted on a combination of chair/fabric comparable to the requested chair/fabric.

Fabric Samples

If you need samples for presentation(s), contact our alliance partners directly at:

Arc-Com	800.223.5466	www.arc-com.com
Maharam	800.645.3943	www.maharam.com
Momentum	800.366.6839	www.memosamples.com
Stinson	800.841.6279	www.cfstinson.com
Ultrafabrics	877.309.6648	www.ultrafabricsllc.com

Analog — Grade R

100% Pre-Consumer Recycled Solution Dyed Nylon
54" Wide
Stain Resistant Finish; Acrylic Backing
Repeat: 14" H x 21.25" V
Cleaning Code: WS, 5:1 Bleach Solution
150,000 Double rubs

60880 Sand	60885 Adobe	60890 Bayou
60881 Smoke	60886 Papaya	60891 Baltic
60882 Cocoa	60887 Flame	60892 Midnight
60883 Coal	60888 Merlot	60893 Truffle
60884 Mocha	60889 Mallard	60894 Onyx

Astral — Grade L

44% Nylon, 31% Cotton, 16% Post-Consumer Recycled Polyester,
9% Polyester
54" Wide
INCASE™ Finish; Acrylic Backing
Repeat: 9.25" H x 8.5" V
Cleaning Code: WS
110,000 Double Rubs

61030 Ash	61036 Taupe	61042 Fire
61031 Smoke	61037 Shark	61043 Tangerine
61032 Moonstone	61038 Bark	61044 Lime
61033 Fog	61039 Truffle	61045 Caribbean
61034 Pebble	61040 Butterscotch	61046 Ocean
61035 Cocoa	61041 Nutmeg	61047 Sapphire

Boardwalk — Grade E

100% Post-Consumer Recycled Polyester
54" Wide
Stain Resistant Finish; Acrylic Backing
Repeat: 7" H x 3.25" V
Cleaning Code: WS, 10:1 Bleach Solution
100,000 Double Rubs

61110 Flame	61117 Caribbean	61124 Taupe
61111 Sunflower	61118 Ocean	61125 Shark
61112 Tangerine	61119 Baltic	61126 Bark
61113 Berry	61120 Pebble	61127 Fog
61114 Amethyst	61121 Sand	61128 Coal
61115 Citron	61122 Chestnut	61129 Onyx
61116 Lime	61123 Godiva	

Crossroads — Grade F

58% Polyester, 27% Pre-Consumer Recycled Polyester,
15% Post-Consumer Recycled Polyester
54" Wide
Crypton® Finish; Moisture Barrier; Antimicrobial
No Repeat
Cleaning Code: WS, 10:1 Bleach Solution, or Crypton® Cleaners
100,000 Double Rubs

61090 Pebble	61096 Berry	61102 Ocean
61091 Honey	61097 Amethyst	61103 Sapphire
61092 Chestnut	61098 Sweet Pea	61104 Mallard
61093 Tangerine	61099 Kiwi	61105 Cocoa
61094 Terracotta	61100 Caribbean	61106 Truffle
61095 Ruby	61101 Baltic	61107 Coal



Dynasty — Grade G

100% Polyurethane
54" Wide
Wipeout® Stain Protection and AEGIS Microbe Shield® Finish;
100% Polyester Backing
No Repeat
Cleaning Code: WS, 4:1 Bleach Solution
300,000 Double Rubs

60500 Mushroom	60511 Emerald	60522 Sand
60501 Sunflower	60512 Caribbean	60523 Butterscotch
60502 Apricot	60513 Aqua	60524 Chamomile
60503 Tangerine	60514 Pacific	60525 Moonstone
60504 Papaya	60515 Baltic	60526 Ice Blue
60505 Fire	60516 Cornflower	60527 Steel
60506 Garnet	60517 Blueberry	60528 Ash
60507 Flamingo	60518 Midnight	60529 Mink
60508 Lilac	60519 Beach	60530 Truffle
60509 Lime	60520 Pebble	60531 Bark
60510 Kiwi	60521 Clay	

Isabella — Grade E

100% Vinyl
54" Wide
Resilience® Finish; Polyester Knit Backing
Repeat: 1.25" H x 2.5" V
Cleaning Code: WS, 10:1 Bleach Solution
300,000 Double Rubs

60850 Wheat	60856 Papaya	60862 Rainstorm
60851 Sand	60857 Lemon	60863 Grape
60852 Nickel	60858 Lime	60864 Goldenrod
60853 Amber	60859 Seafoam	60865 Truffle
60854 Hazelnut	60860 Baltic	60866 Smoke
60855 Terracotta	60861 Sapphire	

Moon Beam 2 — Grade H

61% Polyester, 27% Cotton, 11% Rayon, 1% Nylon
54" Wide
Crypton® Finish; Moisture Barrier; Antimicrobial
No Repeat
Cleaning Code: WS or Crypton® Cleaners
150,000 Double Rubs

60580 Fog	60589 Cayenne	60598 Baltic
60581 Moonstone	60590 Tangerine	60599 Blueberry
60582 Mist	60591 Papaya	60600 Ash
60583 Mineral	60592 Fire	60601 Coal
60584 Stone	60593 Flaming	60602 Raisin
60585 Latte	60594 Plum	60603 Godiva
60586 Topaz	60595 Citron	60604 Truffle
60587 Hazelnut	60596 Sage	
60588 Chestnut	60597 Ocean	



Detailed cleaning instructions available at www.arc-com.com

Arc-Com Program Textiles

Polished — Grade G

100% Polyurethane
54" Wide
Wipeout® Stain Protection and AEGIS Microbe Shield® Finish;
100% Polyester Backing
No Repeat
Cleaning Code: WS, 4:1 Bleach Solution
300,000 Double Rubs

60740 Flame	60750 Cypress	60760 Dune
60741 Mustard	60751 Moonstone	60761 Sand
60742 Nutmeg	60752 Slate	60762 Pebble
60743 Bronze	60753 Federal	60763 Saddle
60744 Copper	60754 Caribbean	60764 Cocoa
60745 Garnet	60755 Periwinkle	60765 Taupe
60746 Burgundy	60756 Sapphire	60766 Truffle
60747 Tea	60757 Mist	60767 Seal
60748 Avocado	60758 Cement	60768 Shark
60749 Seafoam	60759 Fog	60769 Bark

Radius — Grade M

79% Post-Consumer Recycled Polyester, 21% Nylon
54" Wide
Nano-Tex® Finish; Acrylic Backing
Repeat: 13.75" H x 14.5" V
Cleaning Code: WS, 3:1 Bleach Solution
150,000 Double Rubs

61140 Onyx	61145 Tangerine	61150 Sapphire
61141 Ash	61146 Papaya	61151 Federal
61142 Fog	61147 Fire	61152 Amethyst
61143 Chestnut	61148 Avocado	61153 Smoke
61144 Cocoa	61149 Green Apple	61154 Godiva

Robotic — Grade I



100% Polyester
54" Wide
Crypton® Finish; Moisture Barrier; Antimicrobial
Repeat: 3.75" H x 3.75" V
Cleaning Code: WS, 10:1 Bleach Solution, or Crypton® Cleaners
95,000 Double Rubs

60790 Ash	60795 Ochre	60800 Sapphire
60791 Beach	60796 Papaya	60801 Coal
60792 Pebble	60797 Flame	60802 Truffle
60793 Stone	60798 Herb	
60794 Wheat	60799 Baltic	

Santa Fe — Grade H

57% Polyester, 25% Viscose, 18% Cotton
54" Wide
Stain Resistant Finish; No Backing
No Repeat
Cleaning Code: S
100,000 Double Rubs

60270 Pebble	60277 Paprika	60284 Amethyst
60271 Cream	60278 Ruby	60285 Seafoam
60272 Sand	60279 Flamingo	60286 Smoke
60273 Hazelnut	60280 Lime	60287 Cocoa
60274 Mist	60281 Green Apple	60288 Truffle
60275 Clementine	60282 Pacific	
60276 Papaya	60283 Blueberry	

Spot On — Grade J



100% Polyester
54" Wide
Crypton® Finish; Moisture Barrier; Antimicrobial
Repeat: 3.75" H x 3.75" V
Cleaning Code: WS, 10:1 Bleach Solution, or Crypton® Cleaners
70,000 Double Rubs

60810 Sand	60814 Adobe	60818 Periwinkle
60811 Beach	60815 Cherry	60819 Fog
60812 Grain	60816 Bay Leaf	60820 Ash
60813 Nutmeg	60817 Mallard	60821 Coffee

Tally — Grade G

100% Vinyl
54" Wide
PERMABLOK® Finish; Polyester Hi-Loft™ Backing
Repeat: 6" H x 6" V
Cleaning Code: WS, 5:1 Bleach Solution
300,000 Double Rubs

60830 Moonstone	60836 Chili Pepper	60842 Ocean
60831 Green Tea	60837 Kiwi	60843 Blueberry
60832 Antique Gold	60838 Cypress	60844 Grape
60833 Nutmeg	60839 Caribbean	60845 Fog
60834 Terracotta	60840 Seafoam	60846 Beach
60835 Papaya	60841 Sky	60847 Wheat

Abacus Standard 466140 — Grade F

54% Pre-Consumer Recycled Polyester, 46% Post-Consumer Recycled Polyester
 54" Wide
 PFOA-Free Stain Resistant Finish; Acrylic Backing
 Repeat: 14.25" H x 29" V
 Cleaning Code: WS
 65,000 Double Rubs
 This fabric will be railroaded when upholstered

010 Replica 011 Cellar 012 Extract

Anagram 466067 — Grade T

42% Cotton, 32% Polyester, 26% Solution-dyed Nylon
 54" Wide
 PFOA-Free Stain Resistant Finish; Acrylic Backing
 Repeat: 9.25" H x 20" V
 Cleaning Code: S
 90,000 Double Rubs
 This fabric will be railroaded when upholstered

001 Quarry 003 Electric 005 Settle
 002 Hush 004 Range

***Bar 466227 — Grade C**

60% Post-Consumer Recycled Polyester, 40% Post-Industrial Recycled Polyester
 59" Wide
 Stain Resistant Finish; Acrylic Backing
 Repeat: 4.75" H x 5" V
 Cleaning Code: WS, 10:1 Bleach Solution
 60,000 Double Rubs

001 004 007
 002 005
 003 006

Bevel 466131 — Grade D

63% Polyester, 24% Post-Consumer Recycled Polyester, 13% Pre-Consumer Recycled Polyester
 54" Wide
 PFOA-Free Stain Resistant Finish; Polyester Backing
 Repeat: 7.25" H x 13" V
 Cleaning Code: WS
 70,000 Double Rubs

001 Whisper 006 Envy 011 Suede
 002 Surplus 007 Fjord 012 Tarnish
 003 Amber 008 Carbon 013 Cinnabar
 004 Tortoise 009 Lazuli
 005 Chartreuse 010 Geysir

Blip 466129 — Grade Q

44% Rayon, 24% Solution-dyed Nylon, 21% Post-Industrial Recycled Polyester, 11% Post-Consumer Recycled Polyester
 54" Wide
 PFOA-Free Stain Resistant Finish; Acrylic Backing
 Repeat: 13.5" H x 20.25" V
 Cleaning Code: S
 70,000 Double Rubs

001 Miner 004 Tank 007 Robust
 002 Relic 005 Cove 008 Siege
 003 Lowland 006 Coal

***Coin 466233 — Grade B**

43% Polyester, 37% Post-Industrial Recycled Polyester, 20% Post-Consumer Recycled Polyester
 57" Wide
 Stain Resistant Finish; Acrylic Backing
 Repeat: None
 Cleaning Code: WS, 10:1 Bleach Solution
 100,000 Double Rubs

001 004 007
 002 005
 003 006

Contrary 465930 — Grade K

61% Cotton, 33% Nylon, 6% Polyester
 54" Wide
 PFOA-free Stain Resistant Finish; Acrylic Backing
 Repeat: 27.5" H x 18.25" V
 Cleaning Code: S
 65,000 Double Rubs

001 Reveal 004 Willow 006 Ginger
 002 Fog 005 Everglade 007 Carmine

***Disc 466221 — Grade C**

100% Polyester
 57" Wide
 Stain Resistant Finish; Acrylic Backing
 Repeat: 4.75" H x 4.5" V
 Cleaning Code: WS, 10:1 Bleach Solution
 100,000 Double Rubs

001 004 007
 002 005
 003 006

***Divide 466220 — Grade C**

45% Polyester, 36% Post-Industrial Recycled Polyester, 19% Post-Consumer Recycled Polyester
 57" Wide
 Stain Resistant Finish; Acrylic Backing
 Repeat: 3" H x 2.25" V
 Cleaning Code: WS, 10:1 Bleach Solution
 60,000 Double Rubs

001 004 007
 002 005 008
 003 006 009

Exchange 466027 — Grade E

52% Pre-Consumer Recycled Polyester, 48% Post-Consumer Recycled Polyester
 57" Wide
 Stain Resistant Finish; No Backing
 Repeat: 7" H x 5" V
 Cleaning Code: WS, 10:1 Bleach Solution
 60,000 Double Rubs

001 Cinder 005 Vivid 009 Maple
 002 Sable 006 Coastline 010 Rhubarb
 003 Elm 007 Clay 011 Punch
 004 Gull 008 Buck

*Select Maharam textile colors do not have names and are identified by number only

Maharam Program Textiles

*Lariat — Grade C

100% Vinyl
54" Wide
No Finish; Polyester Backing
Repeat: None
Cleaning Code: W, 10:1 Bleach Solution
140,000 Double Rubs

001 Camel	015 Mahogany	028
002 Russet	016 Pebble	029
003 Brick Red	017 Putty	030
004 Indigo	018 Fatigue	031
005 Hunter	019 Ivy	032
006 Black	020 Lake	033
007 Oyster	021 Navy	034
008 Fern	022 Crimson	035
010 Taupe	023	036
011 Chocolate	024	037
012 Oxblood	025	038
013 Ivory	026	
014 Sand	027	

Manner 466177 — Grade B

65% Post-Industrial Recycled Polyester, 35% Post-Consumer Recycled Polyester
54" Wide
PFOA-Free Stain Resistant Finish; No Backing
Repeat: None
Cleaning Code: WS
300,000 Double Rubs

001 Magic	010 Cola	019 Caper
002 Carob	011 Ember	020 Parakeet
003 Porpoise	012 Wagon	021 Greenway
004 Flint	013 Ablaze	022 Aquatic
005 Hush	014 Peel	023 Cottage
006 Nuance	015 Penny	024 Dahlia
007 Thicket	016 Butterscotch	025 Vivid
008 Cocoa	017 Harvest	026 Basin
009 Pathway	018 Lioness	027 Schooner

Medium 463490 — Grade B

100% Polyester
54" Wide
Stain Resistant Finish; No Backing
Repeat: None
Cleaning Code: WS
220,000 Double Rubs

001 Raven	030 Cream	043 Thistle
002 Smoke	031 Sift	044 Washed
003 Alloy	032 Prospect	045 Sculpture
004 Flax	033 Honey	046 Thatched
006 Bark	034 Furrow	047 Hike
007 Espresso	035 Hazard	048 Tangle
008 Pecan	036 Delight	049 Pacific
012 Pumpkin	037 Iris	050 Cosmic
013 Persimmon	038 Lavender	051 Cascade
014 Laser	039 Nautical	052 Blackberry
016 Port	040 Pool	053 Nasturtium
022 Marina	041 Mallard	054 Wooded
029 Pistachio	042 Clover	

Messenger 458640 — Grade B

78% Post-Industrial Recycled Polyester, 15% Polyester, 7% Nylon
54" Wide
PFOA-Free Stain Resistant Finish; No Backing
Repeat: None
Cleaning Code: WS
100,000 Double Rubs

001 Balsa	050 Hydrangea	071 Satsuma
006 Tobacco	051 Lilac	072 Maize
007 Shadow	052 Chestnut	073 Hay
008 Bayou	053 Tangelo	074 Cashew
010 Zinc	054 Lumine	075 Satchel
024 Poppy	055 Russet	076 Fossil
025 Mao	056 Sequoia	077 Ash
027 Violet	057 Carbon	078 Tusk
029 Onyx	058 Snow	079 Oyster
031 Cloud	059 Fennel	080 Pensive
038 Depth	060 Peridot	081 Husk
040 Nile	061 Capri	082 Fireside
041 Azure	062 Ultramarine	083 Chili
043 Fir	063 Squall	084 Robust
045 Cactus	066 Cassis	085 Beyond
046 Ice	067 Aster	086 Voyage
047 Turf	068 Spice	087 Everglade
048 Neon	069 Cherry	088 Electric
049 Isle	070 Vibrant	

Metric 466014 — Grade B

51% Post-Industrial Recycled Polyester, 49% Polyester
54" Wide
PFOA-Free Stain Resistant Finish; No Backing
Repeat: None
Cleaning Code: WS
100,000 Double Rubs

001 Phantom	011 Brick	021 Envy
002 Fog	012 Cardinal	022 Bonsai
003 Fleece	013 Lava	023 Tar
004 Sourdough	014 Oriole	024 Anchor
005 Toffee	015 Cedar	025 Twilight
006 Driftwood	016 Sorrel	026 Admiral
007 Mineral	017 Caramel	027 Seaport
008 Bittersweet	018 Pollen	028 Scuba
009 Arabica	019 Tupelo	
010 Cerise	020 Alligator	

*Oblique 466222 — Grade C

100% Polyester
58" Wide
Stain Resistant Finish; Acrylic Backing
Repeat: 5" H x 6" V
Cleaning Code: WS, 10:1 Bleach Solution
100,000 Double Rubs

001	004	007
002	005	
003	006	

*Select Maharam textile colors do not have names and are identified by number only

***Pick 466224 — Grade B**

100% Polyester
58" Wide
Stain Resistant Finish; Acrylic Backing
Repeat: 5" H x 2.5" V
Cleaning Code: WS, 10:1 Bleach Solution
100,000 Double Rubs

001	005	009
002	006	010
003	007	
004	008	

Plait 466052 — Grade F

53% Pre-Consumer Recycled Polyester, 32% Polyester, 15% Post-Consumer Recycled Polyester
58" Wide
Stain Resistant Finish; No Backing
Repeat: 15" H x 14.75" V
Cleaning Code: WS, 10:1 Bleach Solution
100,000 Double Rubs

001 Cobblestone	005 Sequoia	009 Stormy
002 Sachet	006 Rhubarb	010 Dapper
003 Mesa	007 Sangria	
004 Tavern	008 Reef	

***Pocket 466243 — Grade L**

56% Post-Consumer Recycled Polyester, 24% Solution-dyed Nylon, 20% Post-Industrial Recycled Polyester
54" Wide
PFOA-Free Stain Resistant Finish; Acrylic Backing
Repeat: 4.5" H x 10.5" V
Cleaning Code: WS
130,000 Double Rubs

001	004	007
002	005	
003	006	

Reel 466065 — Grade M

43% Solution-dyed Nylon, 36% Cotton, 21% Polyester
53" Wide
PFOA-Free Stain Resistant Finish; Acrylic Backing
Repeat: 9" H x 4.5" V
Cleaning Code: S
80,000 Double Rubs

001 Bramble	004 Sprout	008 Redwood
002 Antler	005 Mirage	009 Sumac
003 Lichen	006 Cub	

Runner Standard 466167 — Grade I

57% Pre-Consumer Recycled Polyester, 43% Post-Consumer Recycled Polyester
58" Wide
Stain Resistant Finish; Acrylic Backing
Repeat: 7.5" H x 14" V
Cleaning Code: WS
80,000 Double Rubs
This fabric will be railroaded when upholstered

007 Bluff	009 Grove	011 Plot
008 Arid	010 Starboard	012 Carousel

Sequence 466179 — Grade I

100% Solution-Dyed Polyolefin
54" Wide
PFOA-Free Stain Resistant Finish; No Backing; Antimicrobial
Repeat: .25" H x 2.25" V
Cleaning Code: WS, 10:1 Bleach Solution
100,000 Double Rubs
This fabric will be railroaded when upholstered

001 Driftwood	004 Alfresco	007 Veranda
002 Boardwalk	005 Plunge	008 Lodge
003 Rattan	006 Starboard	009 Flare

Shuttle Standard 466168 — Grade H

84% Pre-Consumer Recycled Polyester, 16% Post-Consumer Recycled Polyester
54" Wide
PFOA-Free Stain Resistant Finish; Latex Backing
Repeat: 6.5" V
Cleaning Code: WS
50,000 Double Rubs
This fabric will be railroaded when upholstered

016 Clam	017 Plateau	018 Shoal
----------	-------------	-----------

Skein 466170 — Grade E

56% Post-Consumer Recycled Polyester, 44% Polyester
54" Wide
PFOA-Free Stain Resistant Finish; Acrylic Backing
Repeat: None
Cleaning Code: WS
60,000 Double Rubs

001 Burrow	005 Pomegranate	009 Dock
002 Thatch	006 Cavern	010 Cadet
003 Maize	007 Bitter	011 Marsh
004 Sumac	008 Cinder	

***Technic 466226 — Grade B**

60% Post-Industrial Recycled Polyester, 40% Post-Consumer Recycled Polyester
55" Wide
Stain Resistant Finish; Acrylic Backing
Repeat: None
Cleaning Code: WS, 10:1 Bleach Solution
90,000 Double Rubs

001	003	005
002	004	

***Tilt 466256 — Grade M**

56% Cotton, 35% Polyester, 9% Rayon
55" Wide
PFOA-Free Stain Resistant Finish; Acrylic Backing
Repeat: 13.75" H x 13.5" V
Cleaning Code: S
90,000 Double Rubs

001	004	007
002	005	008
003	006	

*Select Maharam textile colors do not have names and are identified by number only

Maharam Program Textiles

*Vestige 466259 — Grade O

71% Polyester, 29% Rayon
54" Wide
PFOA-Free Stain Resistant Finish; Acrylic Backing
Repeat: 14.25" H x 18.5" V
Cleaning Code: S
75,000 Double Rubs

001	005	009
002	006	010
003	007	
004	008	

Waxen 466078 — Grade D

100% Polyester
54" Wide
Incase™ Finish; Acrylic Backing
Repeat: None
Cleaning Code: S
85,000 Double Rubs

001	Appear	007	Patina	015	Polar
002	Toast	010	Ruby	016	Jay
003	Savanna	011	Ember	017	Gazer
004	Rye	012	Harvest	019	Bayou
005	Frozen	013	Yolk		
006	Highland	014	Fresh		

*Select Maharam textile colors do not have names and are identified by number only

 **Beeline — Grade B**

100% Polyurethane
54" Wide
Antimicrobial, Antibacterial Finish/Polyester Backing
Repeat: None
Cleaning Code: W, 4:1 Bleach Solution
500,000 Double Rubs

9125510 Canvas	9125576 Geyser	9125642 Sprout
9125521 Cork	9125587 Nimbus	9125653 Sundance
9125532 Eclipse	9125598 Oriole	9125664 Tidal
9125543 Eucalyptus	9125609 Parade	9126357 Walnut
9125554 Forge	9125620 Portobello	
9125565 Fossil	9125631 Sisal	

 **Bloc — Grade I**

100% Repreve Solution Dyed Recycled Nylon
54" Wide
No Finish/Nylon Backing
Repeat: 6.75" L x 7" W
Cleaning Code: W, 4:1 Bleach Solution
100,000 Double Rubs

9128502 Bash	9128535 Canal	9129723 Terrapin
9128513 Bluegrass	9129701 Carbon	9128568 Trek
9128524 Breeze	9129712 Slate	9129734 Yam

Echo — Grade D

100% Vinyl
54" Wide
PERMABLOK³® Finish/Polyester Knit Backing
Repeat: 4.5" L x 4.5" W
Cleaning Code: L, 10:1 Bleach Solution
100,000 Double Rubs

9112486 Bisque	9112519 Dusk	9112552 Spring
9112497 Clarity	9112530 Juiced	
9112508 Climate	9112541 Maple	

 **Element — Grade F**

68% Bamboo, 32% Post-Consumer Recycled Polyester
54" Wide
INCASE™ Finish/Acrylic Backing; Antimicrobial
Repeat: None
Cleaning Code: W
100,000 Double Rubs

9123541 Alloy	9123596 Earth	9123651 Soba
9123552 Bananito	9123607 Firefly	9123662 Tangelo
9123563 Buff	9123618 Mortar	9123695 Kernel
9123574 Cassia	9123629 Ondine	9123706 Pesce
9123585 Cyan	9123640 Porto	9123717 Wasabi

 **Elevate — Grade K**

42% Post-Consumer Recycled Polyester,
35% Pre-Consumer Recycled Polyester,
23% Rayon
54" Wide
Crypton® Green Finish; Moisture Barrier; Antimicrobial
Repeat: 27" L x 14" W
Cleaning Code: W or Crypton® Cleaners
50,000 Double Rubs
This fabric will be railroaded when upholstered

9125345 Charged	9125367 Lightful	9125378 Quench
9125356 Ecstatic	9125422 Ocean Deep	9125433 Sunspill



 **Estrella — Grade H**

100% Repreve Solution Dye Recycled Nylon
54" Wide
No Finish/Nylon Backing
Repeat: 18.75" L x 14" W
Cleaning Code: WS, 4:1 Bleach Solution
100,000 Double Rubs

9128337 Driftwood	9128348 Lumen	9128381 Verbena
9129690 Ember	9128359 Nightfall	
9129679 Habitat	9128370 Stone	

 **Foray — Grade F**

54" Wide
100% Polyurethane
Resilience® Finish/Polyester Backing
Repeat: None
Cleaning Code: W, 10:1 Bleach Solution
714,000 Double Rubs

9103862 Acorn	9103972 Clay	9104082 Kashmir
9103873 Artichoke	9103983 Cordovan	9104093 Mineral
9103884 Aubergine	9103994 Currant	9104104 Peapod
9103895 Beige	9104005 Cypress	9104115 Pebble
9103906 Bordeaux	9104016 Dew	9104126 Quarry
9103917 Camel	9104027 Eucalyptus	9104137 Royal
9103928 Cane	9104038 Garnet	9104148 Seaport
9103939 Canvas	9104049 Glacier	9104159 Straw
9103950 Cinder	9104060 Henna	9104170 Woodland
9103961 Citron	9104071 Iron	

 **Idyll — Grade G**

59% Post-Consumer Recycled Polyester, 41% Polyester
54" Wide
Crypton® Green Finish; Moisture Barrier; Antimicrobial
Repeat: 14.5" W x 13.25" L
Cleaning Code: W, 10:1 Bleach Solution or Crypton® Cleaners
50,000 Double Rubs

9118690 Cardamom	9118734 Grain	9118767 Tidal
9118701 Dream	9118745 Harvest	
9118723 Ember	9118756 Inland	



 **Isla — Grade D**

55% Pre-Consumer Recycled Polyester,
29% Post-Consumer Recycled Polyester, 16% Polyester
56" Wide
Crypton® Green Finish; Moisture Barrier; Antimicrobial
Repeat: 7.5" W x 8" L
Cleaning Code: W, 10:1 Bleach Solution or Crypton® Cleaners
50,000 Double Rubs

9119724 Celeste	9119746 Skyline	9119768 Toffee
9119735 Nectar	9119757 Thyme	



 **Mensa — Grade N**

56% Post-Consumer Recycled Polyester,
44% Polyester
54" Wide
Crypton® Green Finish; Moisture Barrier; Antimicrobial
Repeat: 14.5" W x 15.75" L
Cleaning Code: W, 10:1 Bleach Solution or Crypton® Cleaners
100,000 Double Rubs

9123827 Gretna	9123849 Tizzy	9123871 Turret
9123838 Spire	9123860 Tranquil	9123882 Gateway



Momentum Program Textiles

Mojo — Grade L

62% Post-Consumer Recycled Polyester,
38% Polyester
54" Wide
Crypton® Green Finish; Moisture Barrier; Antimicrobial
Repeat: 14.5" W x 9.25" L
Cleaning Code: W, 10:1 Bleach Solution or Crypton® Cleaners
50,000 Double Rubs

9118613 Breeze	9118635 Charged	9118657 Plantain
9118624 Cabana	9118646 Fig	9118668 Poolside



Twist — Grade H

100% Repreve Solution Dye Recycled Nylon
54" Wide
No Finish/Nylon Backing
Repeat: 7.25" L x 7" W
Cleaning Code: W, 4:1 Bleach Solution
100,000 Double Rubs

9128403 Glacier	9128436 Scent	9128469 Vapor
9128414 Graphite	9128447 Shadow	9128480 Vellum
9128425 Reef	9128458 Tamarind	

Oath — Grade D

100% Polyester
55" Wide
Crypton® Finish; Moisture Barrier; Antimicrobial
Repeat: None
Cleaning Code: W, 10:1 Bleach Solution or Crypton® Cleaners
204,000 Double Rubs

9126709 Anise	9126940 Chocolate	9126841 Lodestone
9126720 Azure	9126962 Cordovan	9126852 Madder
9126731 Balsam	9126786 Crocus	9126863 Mineral
9126742 Burlwood	9126929 Driftwood	9126874 Nectar
9126753 Cane	9126797 Ecru	9126951 Sandbar
9126764 Carnelian	9126808 Fieldstone	9126885 Tango
9126918 Celadon	9126819 Foothill	9126896 Taupe
9126775 Charcoal	9126830 Juniper	9126907 Verbena



Vario — Grade C

100% Polyester
54" Wide
InCase® Finish/Acrylic Backing; Antimicrobial
Repeat: None
Cleaning Code: W or Crypton® Cleaners
141,000 Double Rubs

9109912 Aloe	9109956 Cranberry	9110000 Pool
9109923 Aubergine	9109967 Linen	9110011 Scarlet
9109934 Blazer	9109978 Metal	9112123 Pacific
9109945 Calico	9109989 Nightlife	9112134 Macchiatto

Proximity — Grade L

100% Repreve Solution Dye Recycled Nylon
54" Wide
No Finish/Nylon Backing
Repeat: 7" L x 8" W
Cleaning Code: WS, 4:1 Bleach Solution
100,000 Double Rubs

9128139 Alloy	9129668 Java	9128194 Poolside
9128150 Blueprint	9128172 Jojoba	
9128161 Fossil	9128183 Path	

Venue — Grade C

100% Polyester
54" Wide
InCase® Finish/Acrylic Backing; Antimicrobial
Repeat: 0.375" L x 0.5" W
Cleaning Code: W or Crypton® Cleaners
120,000 Double Rubs

9110033 Blackstone	9110066 Sesame	9110095 Wave
9110044 Granny Smith	9110077 Tory	9112145 Scorch
9110055 Radish	9110085 Truffle	9112156 Gulf Stream

Silica Tech — Grade F

51% Silicone, 49% Polyester (100% Silicone Face)
54" Wide
No Finish/100% Polyester Backing
Repeat: None
Cleaning Code: WS, 4:1 Bleach Solution
270,000 Double Rubs

9127875 Calm	9127930 Mineralize	9127985 Verdigris
9127886 Fog	9127941 Paloma	9127996 Vintage
9127897 Gleam	9127952 Sablewood	9128007 Willow
9127908 Kohl	9127963 Sandstone	
9127919 Macadamia	9127974 Urbanite	

Whim — Grade H

54" Wide
100% Repreve Solution Dyed Recycled Nylon
No Finish/Nylon Backing
Repeat: None
Cleaning Code: WS, 4:1 Bleach Solution
100,000 Double Rubs
This fabric will be railroaded when upholstered

9133606 Alfresco	9133650 Outback	9133694 Seed
9133617 Grappa	9133661 Painterly	9133705 Shitake
9133628 Harvest	9133672 Sable	9133716 Symphony
9133639 Hearthstone	9133683 Scout	9133727 Tanager

Torque — Grade I

42% Post-Consumer Recycled Polyester,
35% Pre-Consumer Recycled Polyester, 23% Rayon
54" W
Crypton® Green Finish; Moisture Barrier; Antimicrobial
Repeat: 16" L x 14" W
Cleaning Code: W or Crypton® Cleaners
50,000 Double Rubs

9125279 Blackest	9125301 Quarry	9125323 Tropicalia
9125444 Clementine	9125455 Skylight	
9125290 Edge	9125312 Taro	



Affinity — Grade G

100% Vinyl
 54" Wide
 Zeron® Finish; 100% Polyester Backing
 Repeat: None
 Cleaning Code: WS
 100,000 Double Rubs

AFF_01	Rhubarb	AFF_05	Egyptian	AFF_09	Bermuda
AFF_02	Salem	AFF_06	Concord	AFF_10	Charleston
AFF_03	Manchester	AFF_07	Chiffon	AFF_11	Kendall
AFF_04	Capri	AFF_08	Stardust	AFF_12	Twilight

Ascend — Grade H

57% Polyester, 43% Nylon
 54" Wide
 Enhanced Soil and Stain Protection; Acrylic Backing
 Repeat: 1.75" H x 1.25" V
 Cleaning Code: WS
 90,000 Double Rubs

ASC_63095	Mist	ASC_63098	Sky	ASC_63101	Tide
ASC_63096	Dune	ASC_63099	Fern	ASC_63102	Trail
ASC_63097	Peony	ASC_63100	Blaze		

Bass Line — Grade K

100% Post Industrial Recycled Solution-Dyed Nylon
 54" Wide
 Non-Flourine Soil and Stain Repellant; Nylon Backing
 Repeat: 7.25" H x 8.5" V
 Cleaning Code: WS
 105,000 Double Rubs

BSL_63055	Mellow	BSL_63058	Metal	BSL_63061	Blue Note
BSL_63056	Bebop	BSL_63059	Treble	BSL_63062	Tuxedo
BSL_63057	Harmony	BSL_63060	Red Hot		

Diva — Grade C

100% Vinyl
 54" Wide
 Advanced Soil and Stain Resistant Top Coat; 100% Polyester Knit Backing
 Repeat: None
 Cleaning Code: WS
 100,000 Double Rubs

DVA_40	Dazzle	DVA_46	Siren	DVA_52	Attitude
DVA_41	Champagne	DVA_47	Allure	DVA_53	Envy
DVA_42	Diamond	DVA_48	Soiree	DVA_54	Fame
DVA_43	Palladium	DVA_49	Limelight	DVA_55	Tux
DVA_44	Platinum	DVA_50	Gala	DVA_56	Passion
DVA_45	Spa	DVA_51	Bronze		

Flex — Grade E

100% Polyester
 54" Wide
 Polartec® Non-PFOA Enhanced Soil and Stain Protection with Polygiene
 Antimicrobial; No Backing
 Repeat: None
 Cleaning Code: WS
 100,000 Double Rubs

FLX_63230	Refresh	FLX_63234	Energize	FLX_63238	Passion
FLX_63231	Lightning	FLX_63235	Zest	FLX_63239	Firecracker
FLX_63232	Contrast	FLX_63236	Storm	FLX_63240	Thunder
FLX_63233	Escape	FLX_63237	Moody		

Juxy — Grade F

100% Vinyl
 54" Wide
 Zeron® Finish; 100% Polyester Backing
 Repeat: 3.3" H x 3.3" V
 Cleaning Code: WS
 100,000 Double Rubs

JUX_01	Crystalline	JUX_06	Sunspot	JUX_11	Burst
JUX_02	Radius	JUX_07	Ariel	JUX_12	Ultraviolet
JUX_03	Phyolite	JUX_08	Vela	JUX_13	Spectra
JUX_04	Pulsar	JUX_09	Basalt		
JUX_05	Photon	JUX_10	Parallax		

Leaps and Bounds — Grade I

61% Polyester, 39% Post Consumer Recycled Polyester
 54" Wide
 Enhanced Soil and Stain Protection; Acrylic Backing
 Repeat: 4.875" H x 3.125" V
 Cleaning Code: WS
 65,000 Double Rubs

LEA_63173	Bounce	LEA_63176	Propel	LEA_63179	Climb
LEA_63174	Skip	LEA_63177	Sprint	LEA_63180	Hop
LEA_63175	Hurdle	LEA_63178	Spring	LEA_63181	Stride

Swivel — Grade L

74% Post Consumer Recycled Polyester, 26% Nylon
 54" Wide
 Enhanced Soil and Stain Protection; Light Acrylic Backing
 Repeat: 9.125" H x 9.5" V
 Cleaning Code: WS
 100,000 Double Rubs

SWV_63120	Granite	SWV_63124	Wire	SWV_63128	Clove
SWV_63121	Chalk	SWV_63125	Cobalt	SWV_63129	Navy
SWV_63122	Red	SWV_63126	Absinthe	SWV_63130	Jet
SWV_63123	Jute	SWV_63127	Amethyst		

View — Grade I



73% Post Consumer Recycled Polyester,
 20% Polyester, 7% Post Industrial Recycled Polyester
 54" Wide
 Crypton® 2.0 Finish; Moisture Barrier; Antimicrobial
 Repeat: 14.75" H x 12.875" V
 Cleaning Code: WS
 60,000 Double Rubs

VIE_63184	Woodland	VIE_63187	Passage	VIE_63191	Adventure
VIE_63185	Red Rocks	VIE_63188	Bluff	VIE_63192	Abbyss
VIE_63186	Double	VIE_63189	Scene		
	Take	VIE_63190	Vista		

Whirl — Grade L

73% Post Consumer Recycled Polyester, 27% Nylon
 54" Wide
 Enhanced Soil and Stain Protection; Light Acrylic Backing
 Repeat: 9.25" H x 9.875" V
 Cleaning Code: WS
 100,000 Double Rubs

WRL_63195	Azure	WRL_63198	Blue	WRL_63200	Lights Out
WRL_63196	Lemon		Yonder	WRL_63201	Razzle
	Twist	WRL_63199	Good as		Dazzle
WRL_63197	Zing		Gold		

Ultrafabrics Carded Textiles

Brillante 702 — Grade B

100% Polyurethane
54" Wide
No Finish; 55% Viscose Rayon, 45% Polyester Backing
Repeat: None
Cleaning Code: WS, 5:1 Bleach Solution
200,000 Double Rubs

00072 White Opal	36392 Smokey Topaz	59172 Black Satin
25672 Very Blue	44222 Key Lime	72042 Cotton Candy
33422 Quartz	58822 Silver Lining	94192 Iris
35192 Champagne	59072 Onyx	

Pompeii 704 — Grade B

100% Polyurethane
54" Wide
No Finish; 55% Viscose Rayon, 45% Polyester Backing
Repeat: None
Cleaning Code: WS, 5:1 Bleach Solution
200,000 Double Rubs

00092 Cotton	33812 Copper Tone	36292 Brazil
13682 Red Earth	34212 White Smoke	43602 Jade
26362 Cyrus	34272 Hazelnut	59122 Fieldstone
33442 Sand Dune	34302 Mesa	59132 Night Shadow
33632 Sandstorm	35882 River Bank	

Primera 700 — Grade B

100% Polyurethane
54" Wide
No Finish; 55% Viscose Rayon, 45% Polyester Backing
Repeat: None
Cleaning Code: WS, 5:1 Bleach Solution
400,000 Double Rubs

00042 Chalk	34312 Ecu	39542 Desert
13092 Barn Red	34322 Rattan	44382 Seedling
13372 Merlot	34332 Fossil	44392 Herb
25362 Spa	34382 Toffee	56282 Slate
25372 Chambray	34392 Carob	56392 Coal
25382 Blueprint	34402 Java	56842 Mist
34202 Scone	34882 Irish Lace	82172 Terracotta

Strada 703 — Grade B

100% Polyurethane
54" Wide
No Finish; 55% Viscose Rayon, 45% Polyester Backing
Repeat: None
Cleaning Code: WS, 5:1 Bleach Solution
200,000 Double Rubs

00032 Enamel	34292 Pearl Gray	43592 Flag Stone
13332 Picante	36322 Mud Pie	50212 Ocean Night
26532 Armada	36502 Squirrel	58842 Thunder
33662 Desert Sand	37072 Nudar	59152 Black Sea
33702 Caravan	37522 Rich Earth	73082 Spruce
33832 Redwood	38772 Otter	93732 Chili Pepper
33872 Tar Brown	38922 Maple Syrup	93762 Royal Red
34252 Spanish Saddle	43442 Bogg	

Toscana 701 — Grade B

100% Polyurethane
54" Wide
No Finish; 55% Viscose Rayon, 45% Polyester Backing
Repeat: None
Cleaning Code: WS, 5:1 Bleach Solution
200,000 Double Rubs

13582 Sangria	35272 Rustic	44212 Oregano
25692 Deep Sea	35342 Boar	58782 London Fog
31172 Crema	36402 Stagg	59092 Tunnel
33232 White Sand	36592 Topo	72892 Sea Foam
33272 Antler	37222 Stone Wall	73052 Mallard
33392 Golden Oak	43102 Willow	82002 Papaya
35132 Oso	43342 Meadow	94242 Grape

Ultraleather Pro 554 — Grade F

100% Polyurethane
54" Wide
No Finish; 100% Reinforced Rayon Backing
Repeat: None
Cleaning Code: WS
500,000 Double Rubs

0008 White Wash	3352 Shore	5216 Butterfly
1329 Rhubarb	3353 Tundra	5241 Butternut
1357 Cranberry	3376 Dark Chocolate	5618 Dark Knight
2522 Capri	3444 Toasted Bagel	5626 Char
2530 Sky	3595 Cork	5648 Cloud
2547 Sailor	3803 Parfait	5649 Ember
2661 Blue Bird	3811 Swan	5733 Mortar
2711 Blueberry	4443 Laurel	7200 Blush
3087 Woodcres	4453 Persian Green	8229 Campfire
3209 Cougar	4478 Sea Mist	9336 Aubergine
3214 Chestnut	4530 Coastal	9395 Violet

Textile Application Guidelines

National has listed textile application guidelines for each seating series. These guidelines are intended to help educate you of certain fabric characteristics. **Please make a point to review these guidelines when ordering National seating with National fabrics, COM/COL, Arc-Com, Maharam, Momentum, Stinson, and Ultrafabrics fabrics.** Application of the upholstery will be depicted as on the swatch card unless otherwise instructed on the order.

Arc-Com

Pattern	Grade	Fabric Guidelines
Analog	R	2,3
Astral	L	2
Boardwalk	E	2
Crossroads	F	none
Dynasty	G	none
Isabella	E	2
Moon Beam 2	H	none
Polished	G	1
Radius	M	2
Robotic	I	2
Santa Fe	H	none
Spot On	J	2
Tally	G	2

Maharam

Pattern	Grade	Fabric Guidelines
Abacus Standard	F	2
Anagram	T	2
Bar	C	2
Bevel	D	2
Blip	Q	2
Coin	B	2
Contrary	K	2
Disc	C	2
Divide	C	2
Exchange	E	2
Lariat	C	none
Manner	B	none
Medium	B	none
Messenger	B	none
Metric	B	none
Oblique	C	2
Pick	B	2
Plait	F	2
Pocket	L	2
Reel	M	2
Runner Standard	I	2
Sequence	I	2
Shuttle Standard	H	2
Skein	E	none
Technic	B	none
Tilt	M	2
Vestige	O	2
Waxen	D	none

Momentum

Pattern	Grade	Fabric Guidelines
Beeline	B	none
Bloc	I	2,3
Echo	D	1
Element	F	none*
*Aurora executive seating restricted		
Elevate	K	1
Estrella	H	2,3
Foray	F	none
Idyll	G	1,2
Isla	D	1
Mensa	N	1,2
Mojo	L	1,2
Oath	D	1
Proximity	L	2,3
Silica Tech	F	none
Torque	I	1
Twist	H	3
Vario	C	none
Venue	C	none
Whim	H	3

Ultrafabrics

Pattern	Grade	Fabric Guidelines
Brillante	B	none
Pompeii	B	none
Primera	B	none
Strada	B	none
Toscana	B	none
Ultraleather Pro	F	none

Stinson

Pattern	Grade	Fabric Guidelines
Affinity	G	none
Ascend	H	2
Bass Line	K	2,3
Diva	C	1
Flex	E	none
Juxy	F	none
Leaps and Bounds	I	2
Swivel	L	2
View	I	1,2
Whirl	L	2

Ultrafabrics Alliance Program

National has developed a joint program with Ultrafabrics to offer you quality office seating with exciting lines of designer upholsteries.

The Alliance Program will include additional colors in patterns in National’s standard fabric offering, like Essence/Ultraleather™ and Brisa®, as well as new patterns like Primera and Ultraleather Pro. Reference www.NationalOfficeFurniture.com/Alliance for a complete pattern listing, as well as applicable grades and fabric guidelines.

Textile Appearance Guidelines

Please note that these guidelines are here to help you have the best looking product that National can provide to you. Guidelines 1–4 are simply explanations of what you may see on your chair. We can still upholster fabrics associated with these guidelines, but you may see some of the characteristics described.

- 1 Due to thickness and or stiffness this textile may result in gathers and puckers around corners, contours and certain seams.
- 2 Patterns are considered matched directional; however, decorative stitching, tufting/buttons, seams and seat to back on corner, wedge and diagonal units may not align due to pattern configuration.
- 3 Textile with high nylon or wool content (more than 50%) may show signs of material stretch and lack of rebound when room temperatures fluctuate.
- 4 Mohair, velvet and chenille may be easily bruised or have the potential of crooked seams due to the heavy nap and flip.

Textile Restriction Guidelines

Fabrics associated with guidelines 5 and 6 prevent us from upholstering the applicable chair series.

- 5 This textile cannot be used for glue application. Potential issues could include poor adhesion quality to the mating surface, separation of the fabric face from the backing or glue bleeding through the fabric.
- 6 Thin and/or loosely woven textiles cannot be used due to potential fabric separation at the seams.

Reference www.NationalOfficeFurniture.com/Alliance for the most up-to-date fabric guidelines, grades and additional pattern/color availability.

Alliance/COM/COL Application Guidelines

Textile Application Guidelines

Seating Series	1	2	3	4	5	6
Acquaint	✓		✓	✓		✓
Admire	✓		✓	✓		
Arlington	✓		✓	✓		
Arlington Tufted	✓	✓	✓	✓		
Aurora Executive	✓	✓	✓	✓	✓	✓
Aurora Guest	✓		✓	✓		✓
Cinch	✓		✓	✓	✓	
Confide Lounge	✓		✓	✓	✓	✓
Confide Guest	✓		✓	✓		✓
Davari	✓		✓	✓		✓
Eloquence Executive/Lounge	✓		✓	✓		✓
Eloquence Guest/Tandem/Bariatric	✓		✓	✓		
Essay	✓		✓	✓	✓	
Fringe	✓	✓	✓	✓		✓
Fuel Plastic Back	✓		✓	✓		
Fuel Upholstered Back	✓		✓	✓	✓	
Gotcha Plastic Back	✓		✓	✓		
Gotcha Upholstered Back	✓		✓	✓	✓	
Jiminy	✓		✓	✓		✓
Lavoro Mesh/Plastic Back	✓		✓	✓		✓
Lavoro Upholstered Back	✓		✓	✓	✓	✓
Medalist Contemporary	✓	✓	✓	✓		✓
Medalist Traditional/Transitional	✓		✓	✓		✓
Mix-it Mesh/Plastic Back	✓		✓	✓		✓
Mix-it Upholstered Back	✓		✓	✓	✓	✓
Monterrey	✓		✓	✓		✓
Pennant	✓		✓	✓		✓
Remedy	✓	✓	✓	✓		✓
Reno	✓		✓	✓		✓
Respect	✓	✓	✓	✓		✓
Swift	✓	✓	✓	✓		✓
Tag	✓		✓	✓		✓
Timberlane	✓		✓	✓		
Toss	✓		✓	✓		✓
Triumph Non-Wood	✓		✓	✓		
Triumph Wood	✓	✓	✓	✓		✓
Wedges and Cushions	✓		✓	✓		✓
Wander	✓		✓	✓		✓
Whimsy	✓		✓	✓		✓

Result series cannot be ordered standard as COM

Textile Appearance Guidelines

Please note that these guidelines are here to help you have the best looking product that National can provide to you. Guidelines 1–4 are simply explanations of what you may see on your chair. We can still upholster fabrics associated with these guidelines, but you may see some of the characteristics described.

- 1 Due to thickness and or stiffness this textile may result in gathers and puckers around corners, contours and certain seams.
- 2 Patterns are considered matched directional; however, decorative stitching, tufting/buttons, seams and seat to back on corner, wedge and diagonal units may not align due to pattern configuration.
- 3 Textile with high nylon or wool content (more than 50%) may show signs of material stretch and lack of rebound when room temperatures fluctuate.
- 4 Mohair, velvet and chenille may be easily bruised or have the potential of crooked seams due to the heavy nap and flip.

Textile Restriction Guidelines

Fabrics associated with guidelines 5 and 6 prevent us from upholstering the applicable chair series.

- 5 This textile cannot be used for glue application. Potential issues could include poor adhesion quality to the mating surface, separation of the fabric face from the backing or glue bleeding through the fabric.
- 6 Thin and/or loosely woven textiles cannot be used due to potential fabric separation at the seams.

Reference www.NationalOfficeFurniture.com/COMApprovalSearch to search previously evaluated textiles.

COM (Customer's Own Material)

All seating can be upholstered with appropriate material furnished by the customer. All COM/COL must meet applicable codes and regulations, including TB117-2013. By selecting COM/COL, customer certifies that the material meets such codes. Customer is solely responsible for compliance and may contact a) fabric manufacturer to confirm certification or b) assistance from National. National Office Furniture strives to create upholstered products with no added fire retardants, when allowed. Written confirmation is required from the fabric or leather manufacturer stating that the COM/COL provided by customer does not contain any added fire retardant chemicals. Without adequate confirmation, National will assume the COM/COL contains fire retardant chemicals and will label the product accordingly. Prices are listed under grade 2.

Yardage requirements shown in this list are based on the use of non-directional fabric 54" wide and the fabric being cut "up the roll." If the COM fabric is to be railroaded, please contact customer service for revised yardage requirements.

- When ordering 10 or more COM chairs, consult customer service for exact yardage requirements.
- Reference pages 637-669 for specific repeat COM ydg. requirements.
- Directional covers, such as stripes, patterns and plaids may not meet your satisfaction due to contoured shapes and tufting of some models. Should you require such a selection, orders are not subject to return. If in doubt, contact customer service prior to placing the order.
- Please refer to textile application guidelines listed on p. 32 or the COM Approval Search on www.NationalOfficeFurniture.com when ordering a COM.

Customer's Own Leather (COL)

National is pleased to cooperate with COL selections whenever this special need arises. Customer's own leather specifications for National seating shown within this price list are based on an average hide size of 45-50 square feet. Consult customer service for requirements for other hide sizes. Customer is responsible for the leather meeting the appropriate California TB117 Standard. Prices are listed under grade 3.

- Please note, leather is a natural product and variation in texture is a pleasing quality belonging exclusively to high grade, full top grain leathers.
- All square footage requirements are based on usable footage; the shape of a hide and the usable, clean footage may make it necessary for us to request more leather after COL is received.
- Calf hides must be at least 30 square feet of clean and usable matching hides. When specifying calf hides, add 15% to COL requirements shown in the price list.

COM Disposal

- Leftover COM from an order is held for 6 weeks
- COM not tied to an order is held for 3 months

COM/COL Evaluation

National reserves the right to inspect, approve, or reject any COM/COL. National approval signifies only that such textile/leather can be applied to the products for which intended. Such approval does not constitute any responsibility, liability, or warranty on the part of National as to appearance, behavior, durability or tailoring of COM/COL.

COM Decorative Patterns

- Yardage requirements are greatly affected by not only size of repeats, but also by the print or pattern.
- National cuts all seating patterns with aesthetic concerns in mind for high quality and consistency.
- Refer to particular model in price list to find yardage required for pattern.

The line drawing below depicts two seat cushions in necessary/proper placement on a piece of decorative fabric. Please note the unusable fabric.

It is not always appropriate to place a seat pattern at the edge of the fabric. Due to this circumstance, please include an additional ½ yard per order.

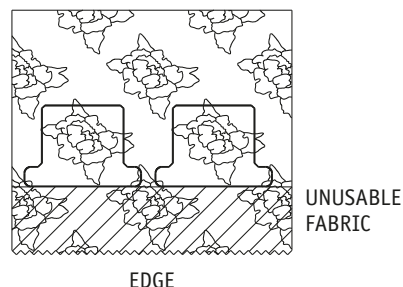

COM Directional Fabrics

- Some COM fabrics are considered directional that may not be considered directional by the fabric supplier, due to the upholstery process used by National.
- Application of COM upholstery will be depicted as on the COM supplier memo sample or website. If a different application is desired the pattern would need to be custom quoted.
- Arc-Com/Maharam/Momentum/Stinson/Ultrafabrics Alliance upholsteries will be applied as depicted on the supplier memo sample or website. If a different application is desired the pattern would need to be custom quoted.

TB133

California Technical Bulletin No. 133 – Flammability test procedure for seating furniture used in public occupancies. National provides pre-approval for TB133 chair/COM fabric combinations. The availability of TB133 on specific chair/alliance fabric combinations can be found at www.NationalOfficeFurniture.com/COMApprovalSearch. Even though we try to keep this document as accurate as possible, the supplier may change contents, finishes, etc... without our knowledge. Customer needs to confirm that the information on this listing matches the content information from the COM supplier. If no test data is available for a particular fabric/chair combination, the TB133 order will not be allowed. These pre-approved alliance fabrics can be ordered as standard product – no custom quote required.

To order seating to meeting the TB133 fire code, specify an "F" at the end of the model number (Ex: N59AAF).

If the COM material you want is not in the COM database, please submit a sample per the instructions outlined on page 34.

If a fabric/chair combination has not been burn tested, the customer has the option of having it tested. Pricing for the testing will be \$1300 list, including shipping for testing services plus the chair price (test sample). TB133 testing requested by the customer will require a custom quote. The fabric/chair burn test results will determine whether future orders can be ordered as standard product or custom quotes. Each instance may vary.

TB133 COM list pricing can be found on pages 466-493.

Letters of assurance are available upon request. A letter of assurance verifies that a TB133 test was conducted on a combination of chair/fabric comparable to the requested chair/fabric.

COM/COL

Confirm COM/COL Application and TB133 Availability

To confirm that a COM fabric is applicable to National seating, send an 8" x 10" memo sample for COM approval to:

To confirm that a COL is applicable to National seating, send a 4" x 4" memo sample for COL approval to:

National Office Furniture
Attn: COM Administrator
1610 Royal Street
Jasper, Indiana 47549-1001

Reference www.NationalOfficeFurniture.com/COMApprovalSearch to see if your COM has already been evaluated for application and TB133.

All COM/COL Orders Must:

1) Include fabric supplier's name, fabric number and color.

To help expedite your order, we recommend the COM or COL supplier to include the following information:

- 1) Dealer Name & Purchase Order Number
- 2) National Model Numbers
- 3) Ship Prepaid To:
National Office Furniture
340 East 11th Avenue
Jasper, Indiana 47549

Without all necessary information listed above to properly match the fabric to the dealer's purchase order, extended lead times may apply.

How to Order National Seating with COM/COL

Specify:

1. Model Number
2. Fabric Manufacturer
3. Pattern Name and/or Number
4. Color Name and/or Number
5. Finish Designator
6. Casters

Sample Order Numbers:

Following is a sample order number for a Model **N69AA** Medalist High Back in Honey finish and upholstered in Knoll Posh in K11635 Turquoise color.

N69AA / Knoll / Posh / K11635 Turquoise / Up the Roll / HN / C3
Model Manufacturer Pattern Color Cut Direction Finish Casters

Acquaint®

Acquaint

ACQUAINT PRODUCT SPECIFICATIONS

59 Series

FRAME CONSTRUCTION

- Constructed of exterior beech with mortise and tenon joints that are securely glued for maximum joint stability
- Wall saving design feature on back legs
- Non-marring nylon glides

SEAT CONSTRUCTION

- 4" high grade polyurethane foam covers a plywood panel for added comfort and support
- Corner blocks screwed and glued in all four corners of the seat

BACK CONSTRUCTION (ALL MODELS)

- Features exterior rails and slats cut from beech wood

UPHOLSTERED BACK CONSTRUCTION

- ½" high grade polyurethane foam covers contoured panel for added support and comfort

ARMS

- Available with black protective polyurethane arm caps for added durability

CONTRASTING FABRICS

- All models available with contrasting fabric

FINISH

- A catalyzed top coat that resists denting, peeling and reactions to chemicals
- Can be cleaned with a damp cloth
- When specifying Brighton and Natural finish, variation in color is acceptable due to the nature of beech wood characteristics
- Features our silver ion antimicrobial finish which inhibits the growth of bacteria and microbes

WOOD SPECIES

- Beech

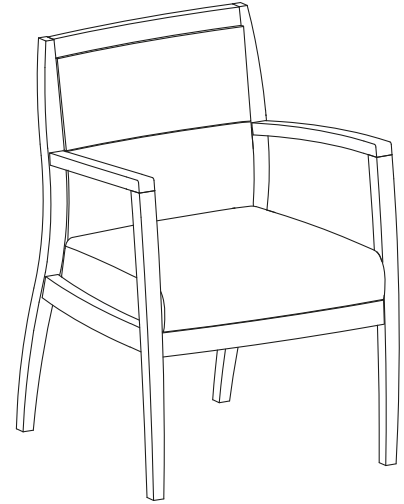

All Acquaint models may be ordered to meet TB133 fire code.

To order seating to meet the TB133 fire code, specify an "F" at the end of the model number (Ex: N59AAF).

Reference pages 465-493 for TB133 Fabric Matrix and pricing.

Please consult customer service for applicable Arc-Com, COM, Maharam, Momentum, Stinson or Ultrafabrics fabric.



For comprehensive sustainability information that includes LEED® point contribution, visit NationalOfficeFurniture.ecoScorecard.com.

FABRICS

- Grade 1 American Graffiti
- Cali
- Plush
- Ridge
- Speedway
- Stardust
- Grade 2 Cathedral
- COM
- Orbit
- Pixie
- Sedona
- Shenanigans
- Spectrum
- Strand
- Tranquility
- Twilight

- Grade 3 Boardwalk
- COL
- Jacks
- Pop Rocks
- Grade 4 Big City
- Bumble
- Connect Four
- Echo
- Silvertex
- Grade 6 Essence/Ultraleather
- Flock
- Scribe

- Grade 7 Brisa
- Brisa Distressed
- Promessa
- Silica
- Grade L7 Davenport
- Grade L8 Showcase

FINISHES

- | | |
|-------------|--------------------|
| IM Brighton | CW Cordovan |
| NM Natural | DW Judicial |
| HN Honey | MH Mocha |
| CL Caramel | 405 Designer White |
| TF Truffle | 462 Cinder |
| AC Autumn | 792 Sable |
| MC Amber | 793 Acorn |

To You In
10
DAYS
...or Less

Shaded model numbers are available on our "To You in 10 Days or Less" Quick Delivery program and will be delivered within 10 days.

To Order, Specify:

1. Model Number
2. Fabric Grade Number
3. Cover Number
4. Finish Designator

• See page 37 for Acquaint options

Half Upholstered Back

Model No. Grade / List Price

Quick Delivery Model: QN59AA

		1	2/COM	3/COL	4	6	7	L7	L8
N59AA		\$ 907	928	938	952	997	1034	1211	1268
N59AAT	Black Polyurethane Arm Caps	994	1015	1025	1039	1084	1121	1298	1355
N59DD	Exposed Wood Slats	999	1020	1030	1044	1089	1126	1303	1360
N59DDT	Exposed Wood Slats/ Black Polyurethane Arm Caps	1084	1105	1115	1129	1174	1211	1388	1445

Dimensions

Width	24	Seat Height	18½	Arm Height	27	Weight	34
Depth	24	Seat Depth	19½	Back Height	17¼	Cubic Ft.	15.5
Height	34	Seat Width	20¾	Back Width	17½		

• Contrasting fabric option – specify X (i.e., N59AAX); see below. For list pricing, use your electronic specification tool or contact customer service

To Order Contrasting Fabric, Specify:

1. Model Number plus "X"
2. Back Fabric Grade Number/Cover Number
3. Extreme Back Fabric Grade Number/Cover Number
4. Seat Fabric Grade Number/Cover Number
5. Finish Designator



N59AA



N59AAT



N59DD

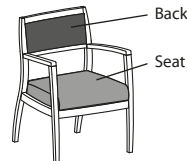

N59AAX

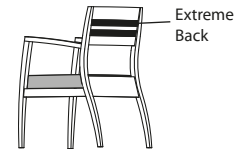

N59DDX

Fully Upholstered Back

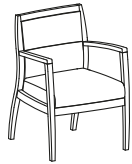

N59BB

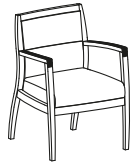

N59BBT



N59JJ

Model No.

Grade / List Price

Quick Delivery Model: QN59BB

		1	2/COM	3/COL	4	6	7	L7	L8
N59BB		\$ 958	986	999	1018	1078	1127	1364	1439
N59BBT	Black Polyurethane Arm Caps	1043	1071	1084	1103	1163	1212	1449	1524
N59JJ	Exposed Wood Slats	1050	1075	1087	1105	1160	1205	1422	1491
N59JJT	Exposed Wood Slats/ Black Polyurethane Arm Caps	1137	1162	1174	1192	1247	1292	1509	1578

Dimensions

Width	24	Seat Height	18½	Arm Height	27	Weight	36
Depth	24	Seat Depth	18¾	Back Height	17¼	Cubic Ft.	15.5
Height	34	Seat Width	20¾	Back Width	17½		

• Contrasting fabric option – specify X (i.e., N59BBX); see below. For list pricing, use your electronic specification tool or contact customer service

To Order Contrasting Fabric, Specify:

1. Model Number plus "X"
2. Back Fabric Grade Number/Cover Number
3. Lumbar Fabric Grade Number/Cover Number
4. Extreme Back Fabric Grade Number/Cover Number
5. Extreme Lumbar Fabric Grade Number/Cover Number
6. Seat Fabric Grade Number/Cover Number
7. Finish Designator

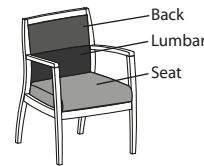

N59BBX

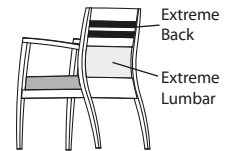

N59JJX

Slat Back

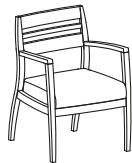

N59CC

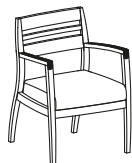

N59CCT

		1	2/COM	3/COL	4	6	7	L7	L8
N59CC		\$ 976	997	1007	1021	1066	1103	1280	1337
N59CCT	Black Polyurethane Arm Caps	1063	1084	1094	1108	1153	1190	1367	1424

Dimensions

Width	24	Seat Height	18½	Arm Height	27	Weight	32
Depth	24	Seat Depth	19½	Back Height	17¼	Cubic Ft.	15.5
Height	34	Seat Width	20¾	Back Width	17½		

Acquaint

**To You In
10
DAYS
...or Less**

Shaded model numbers are available on our "To You in 10 Days or Less" Quick Delivery program and will be delivered within 10 days.

To Order, Specify:

1. Model Number
 2. Fabric Grade Number
 3. Cover Number
 4. Finish Designator
- See page 37 for Acquaint options

Slat Back Upholstered Lumbar



N59HH



N59HHT

Model No.	Grade / List Price							
	1	2/COM	3/COL	4	6	7	L7	L8
N59HH	\$ 1033	1054	1064	1078	1123	1160	1337	1394
N59HHT Black Polyurethane Arm Caps	1118	1139	1149	1163	1208	1245	1422	1479

Dimensions

Width	24	Seat Height	18½	Arm Height	27	Weight	34
Depth	24	Seat Depth	18¾	Back Height	17¼	Cubic Ft.	15.5
Height	34	Seat Width	20¾	Back Width	17½		

- Contrasting fabric option – specify X (i.e., N59HHX); see below. For list pricing, use your electronic specification tool or contact customer service

To Order Contrasting Fabric, Specify:

1. Model Number plus "X"
2. Lumbar Fabric Grade Number/Cover Number
3. Extreme Lumbar Fabric Grade Number/Cover Number
4. Seat Fabric Grade Number/Cover Number
5. Finish Designator

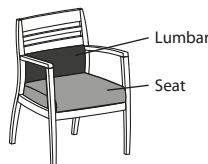

N59HHX

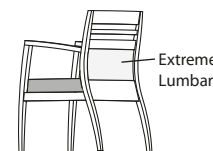

N59HHX

Bariatric Half Upholstered

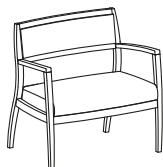

N59MM

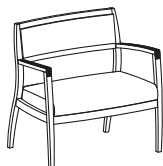

N59MMT

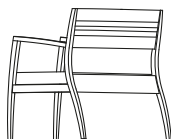

N59PP

Model No.	Grade / List Price							
	1	2/COM	3/COL	4	6	7	L7	L8
N59MM	\$ 1596	1631	1647	1671	1746	1808	2103	2198
N59MMT Black Polyurethane Arm Caps	1683	1718	1734	1758	1833	1895	2190	2285
N59PP Exposed Wood Slats	1683	1715	1731	1753	1823	1880	2156	2244
N59PPT Exposed Wood Slats/ Black Polyurethane Arm Caps	1769	1801	1817	1839	1909	1966	2242	2330

Dimensions

Width	35	Seat Height	18½	Arm Height	27	Weight	47
Depth	24	Seat Depth	19½	Back Height	17¼	Cubic Ft.	24.5
Height	34	Seat Width	31	Back Width	38½		

- Contrasting fabric option – specify X (i.e., N59MMX); see below. For list pricing, use your electronic specification tool or contact customer service
- Tested to and meets 500 lb. weight load

To Order Contrasting Fabric, Specify:

1. Model Number plus "X"
2. Back Fabric Grade Number/Cover Number
3. Extreme Back Fabric Grade Number/Cover Number
4. Seat Fabric Grade Number/Cover Number
5. Finish Designator

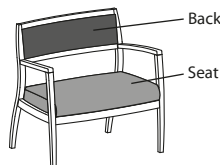

N59MMX



N59PPX

Bariatric Slat Back



N59KK



N59KKT

Model No.

Grade / List Price

		1	2/COM	3/COL	4	6	7	L7	L8
N59KK		\$ 1646	1667	1677	1691	1736	1773	1950	2007
N59KKT	Black Polyurethane Arm Caps	1733	1754	1764	1778	1823	1860	2037	2094

Dimensions

Width	35	Seat Height	18½	Arm Height	27	Weight	45
Depth	24	Seat Depth	19½	Back Height	17¼	Cubic Ft.	24.5
Height	34	Seat Width	31	Back Width	38½		

- Tested to and meets 500 lb. weight load

Armless Half Upholstered



N59AL



N59DL

Quick Delivery Model: QN59AL

		1	2/COM	3/COL	4	6	7	L7	L8
N59AL		\$ 872	893	903	917	962	999	1176	1233
N59DL	Exposed Wood Slats	965	986	996	1010	1055	1092	1269	1326

Dimensions

Width	24	Seat Height	18½	Back Height	17¼	Weight	33
Depth	24	Seat Depth	19½	Back Width	17½	Cubic Ft.	15.5
Height	34	Seat Width	20¾				

- Contrasting fabric option – specify X (i.e., N59ALX); see below. For list pricing, use your electronic specification tool or contact customer service

To Order Contrasting Fabric, Specify:

1. Model Number plus "X"
2. Back Fabric Grade Number/Cover Number
3. Extreme Back Fabric Grade Number/Cover Number
4. Seat Fabric Grade Number/Cover Number
5. Finish Designator

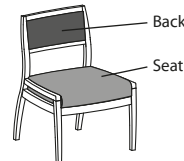

N59ALX



N59DLX

To You In
10 DAYS
...or Less

Shaded model numbers are available on our "To You in 10 Days or Less" Quick Delivery program and will be delivered within 10 days.

To Order, Specify:

1. Model Number
2. Fabric Grade Number
3. Cover Number
4. Finish Designator

• See page 37 for Acquaint options

Armless Fully Upholstered

Model No.

Grade / List Price

Quick Delivery Model: QN59BL



N59BL



N59JL

	1	2/COM	3/COL	4	6	7	L7	L8
N59BL	\$ 924	952	965	984	1044	1093	1330	1405
N59JL Exposed Wood Slats	1015	1040	1052	1070	1125	1170	1387	1456

Dimensions

Width	24	Seat Height	18½	Back Height	17¼	Weight	35
Depth	24	Seat Depth	18¾	Back Width	17½	Cubic Ft.	15.5
Height	34	Seat Width	20¾				

• Contrasting fabric option – specify X (i.e., N59BLX); see below. For list pricing, use your electronic specification tool or contact customer service

To Order Contrasting Fabric, Specify:

1. Model Number plus "X"
2. Back Fabric Grade Number/Cover Number
3. Lumbar Fabric Grade Number/Cover Number
4. Extreme Back Fabric Grade Number/Cover Number
5. Extreme Lumbar Fabric Grade Number/Cover Number
6. Seat Fabric Grade Number/Cover Number
7. Finish Designator

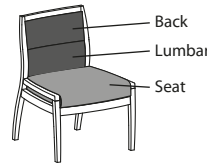

N59BLX

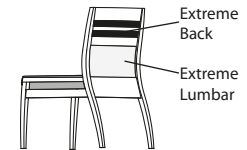

N59JLX

Armless Slat Back



N59CL

Model No.

Grade / List Price

	1	2/COM	3/COL	4	6	7	L7	L8
N59CL	\$ 941	962	972	986	1031	1068	1245	1302

Dimensions

Width	24	Seat Height	18½	Back Height	17¼	Weight	31
Depth	24	Seat Depth	19½	Back Width	17½	Cubic Ft.	15.5
Height	34	Seat Width	20¾				

Armless Slat Back Upholstered Lumbar



N59HL

	1	2/COM	3/COL	4	6	7	L7	L8
N59HL	\$ 999	1020	1030	1044	1089	1126	1303	1360

Dimensions

Width	24	Seat Height	18½	Back Height	17¼	Weight	33
Depth	24	Seat Depth	18¾	Back Width	17½	Cubic Ft.	15.5
Height	34	Seat Width	20¾				

• Contrasting fabric option – specify X (i.e., N59HLX); see below. For list pricing, use your electronic specification tool or contact customer service

To Order Contrasting Fabric, Specify:

1. Model Number plus "X"
2. Lumbar Fabric Grade Number/Cover Number
3. Extreme Lumbar Fabric Grade Number/Cover Number
4. Seat Fabric Grade Number/Cover Number
5. Finish Designator

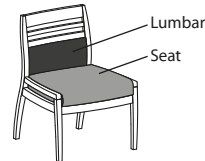

N59HLX

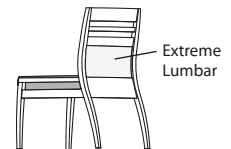

N59HLX

Admire®

Admire

ADMIRE PRODUCT SPECIFICATIONS

55 Series

FRAME CONSTRUCTION

- Constructed of exterior beech with mortise and tenon joints that are securely glued for maximum joint stability
- Non-marring nylon glides

SEAT CONSTRUCTION

- 2" high grade polyurethane foam covers a plywood panel with high tension strip webbing for comfort
- Corner blocks screwed and glued in all four corners of the seat

BACK CONSTRUCTION (All Models)

- Features exterior rails and/or slats cut from steam bent beech wood

BACK CONSTRUCTION (N55AA, N55BB, N55EE, N55HH Models)

- 1" high grade polyurethane foam covers the front of a molded contour plywood back for support and comfort
- The outer (extreme) back features ½" of high grade polyurethane foam

CONTRASTING FABRICS

- All models available with contrasting fabric

FINISH

- A catalyzed top coat resists denting, peeling, and reactions to chemicals
- Can be cleaned with a damp cloth
- When specifying Brighton and Natural finish, variation in color is acceptable due to the nature of beech wood characteristics
- Features our silver ion antimicrobial finish which inhibits the growth of bacteria and microbes

WOOD SPECIES

- Beech

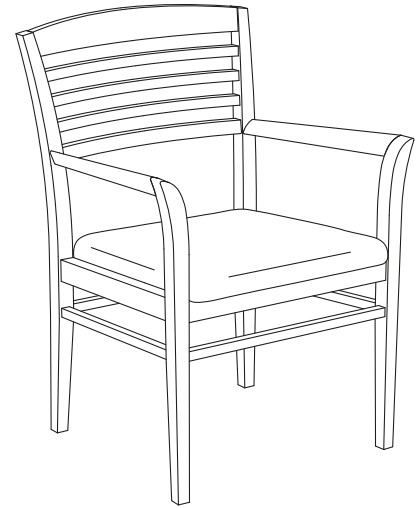

All Admire models may be ordered to meet TB133 fire code.

To order seating to meet the TB133 fire code, specify an "F" at the end of the model number (Ex: N55AAF).

Reference pages 465-493 for TB133 Fabric Matrix and pricing.

Please consult customer service for applicable Arc-Com, COM, Maharam, Momentum, Stinson or Ultrafabrics fabric.



For comprehensive sustainability information that includes LEED® point contribution, visit NationalOfficeFurniture.ecoScorecard.com.

FABRICS

Grade 1 American Graffiti
 Cali
 Plush
 Ridge
 Speedway
 Stardust

Grade 2 Cathedral
 COM
 Orbit
 Pixie
 Sedona
 Shenanigans
 Spectrum
 Strand
 Tranquility
 Twilight

Grade 3 Boardwalk
 COL
 Jacks
 Pop Rocks

Grade 4 Big City
 Bumble
 Connect Four
 Echo
 Silvertex

Grade 6 Essence/Ultraleather
 Flock
 Scribe

Grade 7 Brisa
 Brisa Distressed
 Promessa
 Silica

Grade L7 Davenport

Grade L8 Showcase

FINISHES

IM Brighton	CW Cordovan
NM Natural	DW Judicial
HN Honey	MH Mocha
CL Caramel	405 Designer White
TF Truffle	462 Cinder
AC Autumn	792 Sable
MC Amber	793 Acorn

Admire

To You In 10 DAYS ...or Less
 Shaded model numbers are available on our "To You in 10 Days or Less" Quick Delivery program and will be delivered within 10 days.

To Order, Specify:

1. Model Number
 2. Fabric Grade Number
 3. Cover Number
 4. Finish Designator
- See page 47 for Admire options

Admire

Guest Half Upholstered Back Arms

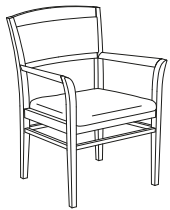

N55EE

Model No.	Grade / List Price							
	1	2/COM	3/COL	4	6	7	L7	L8
N55EE	\$ 735	758	769	785	835	876	1073	1136

Dimensions

Width	24	Seat Width	19¾	Arm Height	25¾	Weight	32
Depth	24	Seat Depth	19½	Back Height	19	Cubic Ft.	13.4
Height	33¾	Seat Height	17½	Back Width	17¾		

• Contrasting fabric option – specify X (i.e., N55EEX); see below. For list pricing, use your electronic specification tool or contact customer service

Guest Fully Upholstered Back Arms

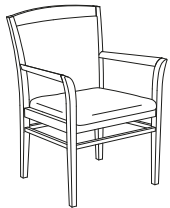

N55AA

Quick Delivery Model: QN55AA

Model No.	Grade / List Price							
	1	2/COM	3/COL	4	6	7	L7	L8
N55AA	\$ 783	818	834	858	933	995	1290	1385

Dimensions

Width	24	Seat Width	19¾	Arm Height	25¾	Weight	32
Depth	24	Seat Depth	19½	Back Height	19	Cubic Ft.	13.4
Height	33¾	Seat Height	17½	Back Width	17¾		

• Contrasting fabric option – specify X (i.e., N55AAX); see below. For list pricing, use your electronic specification tool or contact customer service

To Order Contrasting Fabric, Specify:

1. Model Number plus "X"
2. Back Fabric Grade Number/Cover Number
3. Extreme Back Fabric Grade Number/Cover Number
4. Seat Fabric Grade Number/Cover Number
5. Finish Designator

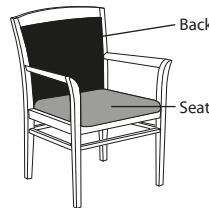

N55AAX

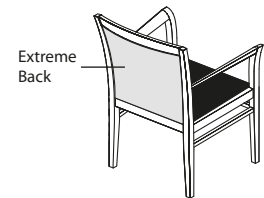

N55AAX Back View

**Guest
Horizontal Slat Back
Arms**

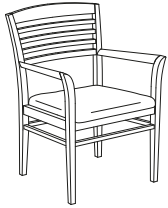

**Model
No.**

Grade / List Price

	1	2/COM	3/COL	4	6	7	L7	L8
N55CC	\$ 802	817	824	835	868	895	1025	1067

Dimensions

Width	24	Seat Width	19¾	Arm Height	25¾	Weight	32
Depth	24	Seat Depth	19½	Back Height	19	Cubic Ft.	13.4
Height	33¾	Seat Height	17½	Back Width	17¾		

**Guest
Half Upholstered Back
Armless**

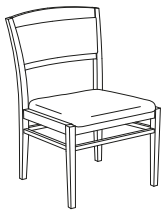

N55HH

	1	2/COM	3/COL	4	6	7	L7	L8
N55HH	\$ 652	675	686	702	752	793	990	1053

Dimensions

Width	24	Seat Width	19¾	Back Height	19	Weight	30
Depth	24	Seat Depth	19½	Back Width	17¾	Cubic Ft.	14.6
Height	33¾	Seat Height	17½				

- Contrasting fabric option – specify X (i.e., N55HHX); see below. For list pricing, use your electronic specification tool or contact customer service

**Guest
Fully Upholstered Back
Armless**

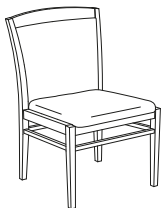

N55BB

	1	2/COM	3/COL	4	6	7	L7	L8
N55BB	\$ 701	736	752	776	851	913	1208	1303

Dimensions

Width	24	Seat Width	19¾	Back Height	19	Weight	30
Depth	24	Seat Depth	19½	Back Width	17¾	Cubic Ft.	14.6
Height	33¾	Seat Height	17½				

- Contrasting fabric option – specify X (i.e., N55BBX); see below. For list pricing, use your electronic specification tool or contact customer service

**Guest
Horizontal Slat Back
Armless**

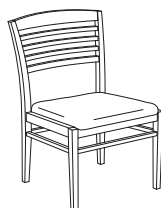

	1	2/COM	3/COL	4	6	7	L7	L8
N55DD	\$ 720	735	742	753	786	813	943	985

Dimensions

Width	24	Seat Width	19¾	Back Height	19	Weight	30
Depth	24	Seat Depth	19½	Back Width	17¾	Cubic Ft.	14.6
Height	33¾	Seat Height	17½				

To Order Contrasting Fabric, Specify:

1. Model Number plus "X"
2. Back Fabric Grade Number/Cover Number
3. Extreme Back Fabric Grade Number/Cover Number
4. Seat Fabric Grade Number/Cover Number
5. Finish Designator

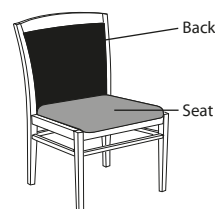

N55BBX

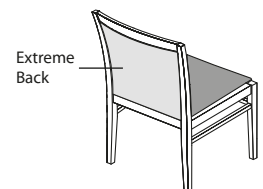

N55BBX Back View

Arlington™

Arlington

ARLINGTON PRODUCT SPECIFICATIONS

FRAME CONSTRUCTION

- Interior and exterior frame constructed of kiln-dried hardwoods, with joints double doweled and securely glued for maximum joint stability
- Tie screws are installed at all critical joints for added strength
- 48-E model side-to-side rails provide strength and mounting platform for the swivel tilt mechanism
- Guest conference models have seat joints supported with additional corner blocks secured with high tensile screws

SEAT AND BACK CONSTRUCTION

- High grade polyurethane foam covers high tension strip webbing for comfort
- 64X-GWXX back offers a high polyurethane foam covering a non-stretch suspension with an extra layer of suspension in the lumbar area for increased support

CONTROL MECHANISM/LIFT (48-EK)

- A standard knee tilt mechanism with a forward locking lever, features a heavy-duty adjustable tension spring for a variety of body sizes
- The standard pneumatic gas cylinder lift allows the seat to raise and lower 2½" and provides spring action for added comfort
- Fingertip adjustment is quick and easy

CONTROL MECHANISM/LIFT (48-ES)

- The standard swivel tilt control features a heavy-duty adjustable tension spring for a variety of body sizes. Made of heavy-duty steel, it operates on dual coil springs with self-lubricating nylon bushings and a quiet rubber stop cushion
- The standard pneumatic gas cylinder lift allows the seat to raise and lower 2½" and provides spring action for added comfort

BASE AND CASTERS

- A five-prong, rigid steel understructure base ensures long life
- All National bases are tested to BIFMA standards using 2500 lb. force
- Caster posts fit directly into steel sleeves, greatly reducing caster socket failure
- A self-lubricating nylon hub liner is standard
- Decorative hardwood caps complement the chair design
- English hooded ball casters are standard

JURY BASE

- Pneumatic jury base
- Memory return swivel



GLIDES

- Guest models feature non-marring nylon glides

TUFTING

- Button tufting utilizes a metal prong unit pulled through both the foam and fabric, then inserted through a self-locking steel washer that is clinched for long life

TRIM NAILS

- Decorative antique brass trim nails are individually hand applied to the arm and seat base for a clean, tailored appearance

FINISH

- All finishes feature a catalyzed top coat which resists denting, peeling and reactions to chemicals
- Can be cleaned with a damp cloth
- Features our silver ion antimicrobial finish which inhibits the growth of bacteria and microbes

WOOD SPECIES

- Maple



All Arlington models may be ordered to meet TB133 fire code.

To order seating to meet the TB133 fire code, specify an "F" at the end of the model number (Ex: 48-EKF).

Reference pages 465-493 for TB133 Fabric Matrix and pricing.

Please consult customer service for applicable Arc-Com, COM, Maharam, Momentum, Stinson or Ultrafabrics fabric.



For comprehensive sustainability information that includes LEED® point contribution, visit NationalOfficeFurniture.ecoScorecard.com.

FABRICS

Grade 1 American Graffiti
Cali
Plush
Ridge
Speedway
Stardust

Grade 2 Cathedral
COM
Orbit
Pixie
Sedona
Shenanigans
Spectrum
Strand
Tranquility
Twilight

Grade 3 Boardwalk
COL
Jacks
Pop Rocks

Grade 4 Big City
Bumble
Connect Four
Echo
Silvertex

Grade 6 Essence/Ultraleather
Flock
Scribe

Grade 7 Brisa
Brisa Distressed
Promessa
Silica

Grade L7 Davenport

Grade L8 Showcase

FINISHES

IM Brighton	CW Cordovan
NM Natural	DW Judicial
HN Honey	MH Mocha
CL Caramel	405 Designer White
TF Truffle	462 Cinder
AC Autumn	792 Sable
MC Amber	793 Acorn

Arlington

Due to the contour shapes and tufted appearance, striped patterns are not recommended on tufted models. Should you require such a selection, such orders are not subject to return.

To Order, Specify:

1. Model Number
2. Fabric Grade Number
3. Cover Number
4. Finish Designator

• See page 53 for Arlington options

High Back Wrapped Arms



Model No.		Grade / List Price							
		1	2/COM	3/COL	4	6	7	L7	L8
48-EK	Knee Tilt	\$ 1551	1618	1650	1696	1841	1960	2531	2714
48-EKN	Knee Tilt/Trim Nails	1551	1618	1650	1696	1841	1960	2531	2714
48-ES	Swivel Tilt	1355	1431	1467	1520	1685	1820	2470	2678
48-ESN	Swivel Tilt/Trim Nails	1355	1431	1467	1520	1685	1820	2470	2678
48-EKJ	Knee Tilt, Jury Base	1776	1843	1875	1921	2066	2185	2756	2939
48-EKNJ	Knee Tilt/Trim Nails, Jury Base	1776	1843	1875	1921	2066	2185	2756	2939
48-ESJ	Swivel Tilt, Jury Base	1580	1656	1692	1745	1910	2045	2695	2903
48-ESNJ	Swivel Tilt/Trim Nails, Jury Base	1580	1656	1692	1745	1910	2045	2695	2903

Dimensions

		48-EK & EKN		48-ES & ESN		Weight	
Width	26½	Height	37¾-40¾	Height	38½-41¼		50
Depth	30¼	Arm Height	25¼-28½	Arm Height	26-28¾	Cubic Ft.	15.9
Seat Depth	18½	Seat Height	17½-20½	Seat Height	18½-21¼		
Seat Width	23½						

Guest Wrapped Arms

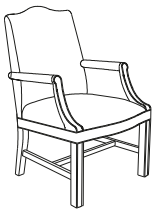

Model No.		Grade / List Price							
		1	2/COM	3/COL	4	6	7	L7	L8
48-GC		\$ 1032	1099	1131	1177	1322	1441	2012	2195
48-GCN	Trim Nails	1032	1099	1131	1177	1322	1441	2012	2195

Dimensions

						Weight	
Width	26	Arm Height	26¾	Seat Width	19¾		43
Depth	28	Seat Height	19½			Cubic Ft.	15.9
Height	38½	Seat Depth	19				

Guest Club

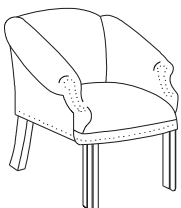

Model No.		Grade / List Price							
		1	2/COM	3/COL	4	6	7	L7	L8
451	Non-tufted/Trim Nails	\$ 1070	1146	1182	1235	1400	1535	2185	2393
451T	Tufted/Trim Nails	1107	1190	1229	1287	1467	1615	2324	2551

Dimensions

						Weight	
Width	28¾	Arm Height	25¾	Seat Width	20		52
Depth	27¾	Seat Height	19½			Cubic Ft.	15.0
Height	32	Seat Depth	19				

**Mobile
Guest
Club**

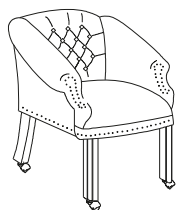

Model No.		Grade / List Price							
		1	2/COM	3/COL	4	6	7	L7	L8
452	Non-tufted/Trim Nails	\$ 1086	1162	1198	1251	1416	1551	2201	2409
452T	Tufted/Trim Nails	1118	1201	1240	1298	1478	1626	2335	2562
Dimensions									
Width	28¾	Arm Height	25¾	Seat Width	20	Weight	52		
Depth	27¾	Seat Height	19½			Cubic Ft.	15.0		
Height	32	Seat Depth	19						

**Guest
Captain**



Model No.		Grade / List Price							
		1	2/COM	3/COL	4	6	7	L7	L8
72X-GUXX	Non-tufted	\$ 668	696	709	728	788	837	1074	1149
72X-GUXT	Non-tufted/Trim Nails	672	700	713	732	792	841	1078	1153
Dimensions									
Width	25¾	Arm Height	26	Seat Width	18½	Weight	36		
Depth	22¾	Seat Height	18½			Cubic Ft.	14.6		
Height	30½	Seat Depth	18						

**Guest
Wood Arms**

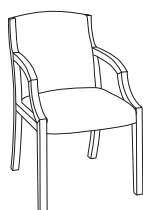

Model No.		Grade / List Price							
		1	2/COM	3/COL	4	6	7	L7	L8
64X-GWXX		\$ 745	776	791	813	881	937	1205	1290
Dimensions									
Width	22¾	Arm Height	25¾	Seat Width	19½	Weight	27		
Depth	25	Seat Height	17¾			Cubic Ft.	16.6		
Height	35	Seat Depth	17¼						

Aurora®

Aurora

AURORA PRODUCT SPECIFICATIONS

65 Series

FRAME CONSTRUCTION

Guest Models

- Legs are 1¼" x ¾" steel rectangular tube
- Cross members are welded ½" diameter wire with ½" diameter x 14-gauge cold-rolled tube
- Available in powder coated Cinder, Platinum Metallic and Satin Nickel Metallic
- Wall saving design feature on back legs
- Non-marring nylon glides

SEAT CONSTRUCTION

High Back and Mid Back Models

- 3½" of high grade polyurethane foam covers a 9-ply solid contoured molded plywood seat panel for support and comfort

Guest Models

- 2" of high grade polyurethane foam covers a solid contoured molded plywood seat panel for support and comfort

BACK CONSTRUCTION

High Back and Mid Back Models

- 2" of high grade polyurethane foam covers a 3-ply solid contoured molded plywood panel
- 9-ply outer molded shell wrapped in ¼" polyurethane foam

Guest Models

- 1½" of high grade polyurethane foam covers a solid contoured molded plywood panel on upholstered back
- 13-ply curved plywood back with polished decorative fasteners on wood back
- Translucent injection molded plastic back with polished decorative fasteners on plastic back

ARMS

High Back and Mid Back Models

- Arms are die-cast aluminum available in polished aluminum or powder coated Cinder, Platinum Metallic and Satin Nickel Metallic
- Arm pads are soft black polyurethane

Guest Models

- Arms are die-cast aluminum available in polished aluminum or powder coated Cinder, Platinum Metallic and Satin Nickel Metallic

CONTROL MECHANISM—KNEE TILT

- The standard knee tilt mechanism features a heavy-duty adjustment tension spring for a variety of body sizes and minimal rise of front seat edge; this allows the users feet to remain planted when the chair is in the reclining position
- The combination gas lift/tilt lock lever allows dual functions with a simple in/out movement for lockout and an up/down movement for height adjustment
- Standard pneumatic gas cylinder lift allows seat to raise and lower 4" and provides spring action for added comfort

CONTROL MECHANISM—SYNCHRONOUS

- Synchronous control allows the back and seat to move in a synchronized 2.3:1 ratio motion
- Free float feature allows the chair to tilt freely
- A side activated telescoping tension adjustment handle provides a comfortable way to adjust back tension to meet individual needs
- The back angle can be locked in one of five positions
- Standard pneumatic gas cylinder lift allows seat to raise and lower 4¼" and provides spring action for added comfort

SEATSLIDE

- Seat depth can be adjusted to seven different positions within a 2½" range

BASE AND CASTERS

- Die-cast aluminum five-prong base available in polished aluminum or powder coated Cinder, Platinum Metallic and Satin Nickel Metallic
- Black, hard double wheel casters, which work on multiple surfaces, are standard
- Black, soft double wheel casters, for use on hard floors, are available at an upcharge
- All National bases are tested to BIFMA standards using 2500 lb. force

FINISH

- Wood models feature a catalyzed top coat that resists denting, peeling and reactions to chemicals
- Can be cleaned with a damp cloth
- Features our silver ion antimicrobial finish which inhibits the growth of bacteria and microbes

WOOD SPECIES

- Hard maple

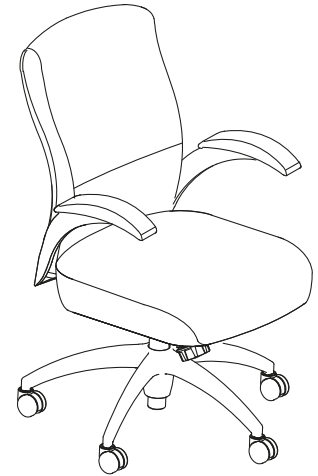

All Aurora models with the exception of N65HHP and N65HHA may be ordered to meet TB133 fire code.

To order seating to meet the TB133 fire code, specify an "F" at the end of the model number (Ex: N65AAPF).

Reference pages 465-493 for TB133 Fabric Matrix and pricing.

Please consult customer service for applicable Arc-Com, COM, Maharam, Momentum, Stinson or Ultrafabrics fabric.



For comprehensive sustainability information that includes LEED® point contribution, visit NationalOfficeFurniture.ecoScorecard.com.

FABRICS

- Grade 1 American Graffiti
- Cali
- Plush
- Ridge
- Speedway
- Stardust
- Grade 2 Cathedral
- COM
- Orbit
- Pixie
- Sedona
- Shenanigans
- Spectrum
- Strand
- Tranquility
- Twilight

- Grade 3 Boardwalk*
- COL
- Jacks
- Pop Rocks
- Grade 4 Big City
- Bumble
- Connect Four
- Echo
- Silvertex
- Grade 6 Essence/Ultraleather
- Flock
- Scribe

- Grade 7 Brisa
- Brisa Distressed
- Promessa
- Silica
- Grade L7 Davenport
- Grade L8 Showcase

*Not available on high and mid back models

WOOD FINISHES

N65GG Models Only

- IM Brighton CW Cordovan
- NM Natural DW Judicial
- HN Honey MH Mocha
- CL Caramel 405 Designer White
- TF Truffle 462 Cinder
- AC Autumn 792 Sable
- MC Amber 793 Acorn

POWDER COAT PAINTS

- 462 Cinder
- 501 Platinum Metallic
- 503 Satin Nickel Metallic

CASTERS

- C3 Hard (standard)
- C4 Soft (add \$24 list)

To Order, Specify:

1. Model Number
2. Fabric Grade Number
3. Cover Number
4. Powder Coat Paint (if applicable)
5. Casters

• See page 59 for Aurora options

**High Back
Knee Tilt**

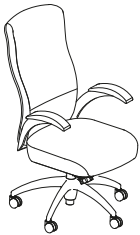

Model No.	Grade / List Price	Grade / List Price							
		1	2/COM	3/COL	4	6	7	L7	L8
N65CCP	Powder Coat	\$ 1316	1360	1381	1411	1506	1584	1958	2078
N65CCSP	Powder Coat/Seatslide	1409	1453	1474	1504	1599	1677	2051	2171
N65CCA	Polished Aluminum	1492	1536	1557	1587	1682	1760	2134	2254
N65CCSA	Polished Aluminum/Seatslide	1583	1627	1648	1678	1773	1851	2225	2345
Dimensions									
Width	27	Arm Height	27¾-32½	Seat Depth	18¾	Weight	60		
Depth	27½	Seat Height	17¾-21¼	Seat Depth with		Weight with			
Depth with		Seat Height with		Seatslide	19½-21½	Seatslide	64		
Seatslide	28¼-30½	Seatslide	18¾-22¾	Back Height	28	Cubic Ft.	20.4		
Height	43¾-47½	Seat Width	21	Back Width	17¾				

**Mid Back
Knee Tilt**



Model No.	Grade / List Price	Grade / List Price							
		1	2/COM	3/COL	4	6	7	L7	L8
N65DDP	Powder Coat	\$ 1259	1300	1320	1349	1439	1513	1867	1981
N65DDSP	Powder Coat/Seatslide	1349	1390	1410	1439	1529	1603	1957	2071
N65DDA	Polished Aluminum	1434	1475	1495	1524	1614	1688	2042	2156
N65DDSA	Polished Aluminum/Seatslide	1525	1566	1586	1615	1705	1779	2133	2247
Dimensions									
Width	27	Arm Height	27¾-32½	Seat Depth	18¾	Weight	59		
Depth	27½	Seat Height	17¾-21¼	Seat Depth with		Weight with			
Depth with		Seat Height with		Seatslide	19½-21½	Seatslide	63		
Seatslide	28¼-30½	Seatslide	18¾-22¾	Back Height	23	Cubic Ft.	20.4		
Height	38¾-42½	Seat Width	21	Back Width	17¾				

**High Back
Synchronous**

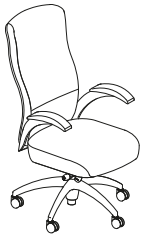

**Model
No.**

Grade / List Price

		1	2/COM	3/COL	4	6	7	L7	L8
N65AAP	Powder Coat	\$ 1405	1449	1470	1500	1595	1673	2047	2167
N65AASP	Powder Coat/Seatslide	1496	1540	1561	1591	1686	1764	2138	2258
N65AAA	Polished Aluminum	1580	1624	1645	1675	1770	1848	2222	2342
N65AASA	Polished Aluminum/Seatslide	1672	1716	1737	1767	1862	1940	2314	2434

Dimensions

Width	27	Arm Height	27¾-32½	Seat Depth	18½	Weight	62
Depth	27	Seat Height	18-21½	Seat Depth with Seatslide	19-21	Weight with Seatslide	65
Depth with Seatslide	26¾-29	Seatslide	18¼-22¾	Back Height	27¾	Cubic Ft.	20.4
Height	44½-48	Seat Width	21	Back Width	17¾		

**Mid Back
Synchronous**



		1	2/COM	3/COL	4	6	7	L7	L8
N65BBP	Powder Coat	\$ 1346	1387	1407	1436	1526	1600	1954	2068
N65BBSP	Powder Coat/Seatslide	1437	1478	1498	1527	1617	1691	2045	2159
N65BBA	Polished Aluminum	1522	1563	1583	1612	1702	1776	2130	2244
N65BBSA	Polished Aluminum/Seatslide	1613	1654	1674	1703	1793	1867	2221	2335

Dimensions

Width	27	Arm Height	27¾-32½	Seat Depth	18½	Weight	61
Depth	27	Seat Height	18-21½	Seat Depth with Seatslide	19-21	Weight with Seatslide	64
Depth with Seatslide	28¼-30½	Seatslide	18¼-22¾	Back Height	22¾	Cubic Ft.	20.4
Height	39½-43	Seat Width	21	Back Width	17¾		

To Order, Specify:

1. Model Number
 2. Fabric Grade Number
 3. Cover Number
 4. Finish Designator (if applicable)
 5. Powder Coat Paint
- See page 59 for Aurora options

Guest Upholstered Back

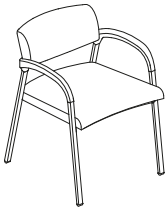

Model No.	Grade / List Price	Grade / List Price							
		1	2/COM	3/COL	4	6	7	L7	L8
N65EEP	Powder Coat	\$ 960	983	994	1010	1060	1101	1298	1361
N65EEA	Polished Aluminum/Powder Coat	1064	1087	1098	1114	1164	1205	1402	1465
Dimensions									
Width	23	Arm Height	26	Seat Depth	18¾	Weight	31		
Depth	23½	Seat Height	19	Back Height	14	Cubic Ft.	16.8		
Height	30	Seat Width	19	Back Width	18½				

Guest Wood Back

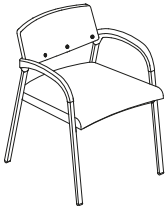

Model No.	Grade / List Price	Grade / List Price							
		1	2/COM	3/COL	4	6	7	L7	L8
N65GGP	Powder Coat	\$ 1014	1037	1048	1064	1114	1155	1352	1415
N65GGA	Polished Aluminum/Powder Coat	1119	1142	1153	1169	1219	1260	1457	1520
Dimensions									
Width	23	Arm Height	26	Seat Depth	18¾	Weight	31		
Depth	23½	Seat Height	19	Back Height	14	Cubic Ft.	16.8		
Height	30	Seat Width	19	Back Width	18½				

• Must specify wood finish

Guest Translucent Back

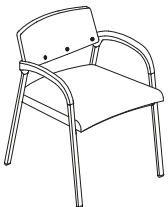

DISCONTINUED - 12/31/16

Model No.	Grade / List Price	Grade / List Price							
		1	2/COM	3/COL	4	6	7	L7	L8
N65HHP	Powder Coat	\$ 891	913	924	940	988	1028	1219	1280
N65HHA	Polished Aluminum/Powder Coat	994	1016	1027	1043	1091	1131	1322	1383
Dimensions									
Width	23	Arm Height	26	Seat Depth	18¾	Weight	31		
Depth	23½	Seat Height	19	Back Height	14	Cubic Ft.	16.8		
Height	30	Seat Width	19	Back Width	18½				

Cinch®

Cinch

CINCH GUEST PRODUCT SPECIFICATIONS

45 Series

FRAME CONSTRUCTION

- Legs are made of 1¼" x ⅝" thick steel for strength and durability
- Cross members are constructed of ¾" x 15-gauge thick steel
- Leg is joined to cross member bar with metal inert gas (MIG) welds
- Back support brackets utilize ⅝" thick steel plates

SEAT AND BACK CONSTRUCTION

- Contoured, injection molded polypropylene seat and back
- Seat and backrest are attached to the frame with screws

UPHOLSTERED SEAT CONSTRUCTION

- ½" foam

ARM REST

- Die-cast aluminum arm upright covered with an (ABS) black plastic arm cap
- Can be easily installed or removed with an allen wrench

STANDARD AND OVERSIZED TABLET ARMS

- Black laminated MDF hinged surface with radius edge mounted on V-shaped arm rest
- Available as left-handed or right-handed
- Can be easily installed or removed with an allen wrench

GANGING BRACKET—STACKER

- Chair is equipped with simple to align and easy to assemble ganging device; works for ganging non-mobile armless to armless
- Separate metal ganging bracket (N45GB) can be specified when ganging non-mobile arm, armless, or tablet arm models
- N45GB comes with a display card for row and seat indication
- Ganging not recommended for mobile models
- Offered in black only

BOOKRACK

- Made of ⅝" and ¼" steel wire
- For convenient storage use, installs easily with simple clip-on method
- Offered in black only

GLIDES

- Durable hard black nylon glides are standard
- Become scratch-resistant protectors when stacking chairs
- Soft glides are available for an additional upcharge

CASTERS

- Durable casters work on multiple surfaces

TRANSPORT DOLLY

- 1" x 16-gauge tubular steel handle, 1¼" x 16-gauge tubular steel base
- 4" wheels with locks
- Foldable handle allows for storage
- Transport dolly not necessary for mobile models

FINISH

- Cinder and Platinum Metallic frames are finished with electrostatically baked-on powder coat paint

STACKING CAPABILITIES

Cinch Model	Stacked on Floor	Stacked on Dolly
Plastic Stacker	15 High	12 High
Plastic Stacker w/Arms	5 High	N/A
Plastic Stacker w/ Small or Large Tablet Arm	Stacking Not Recommended	Stacking Not Recommended
Mobile Stacker	12 High	No Dolly Needed
Mobile Stacker w/Arms	4 High	N/A
Mobile Stacker w/ Small or Large Tablet Arm	Stacking Not Recommended	Stacking Not Recommended

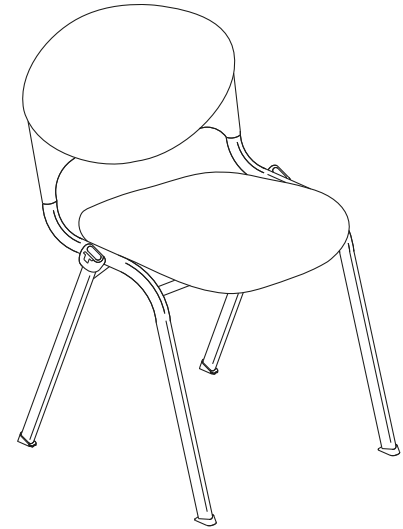

All Cinch models meet TB133 fire code.

No special indicator or upcharge required for plastic models.

To order upholstered models to meet the TB133 fire code, specify an "F" at the end of the model number (Ex: N45AUF).

Reference pages 465-493 for TB133 Fabric Matrix and pricing.

Please consult customer service for applicable Arc-Com, COM, Maharam, Momentum, Stinson or Ultrafabrics fabric.



For comprehensive sustainability information that includes LEED® point contribution, visit NationalOfficeFurniture.ecoScorecard.com.

FABRICS

- Grade 1 American Graffiti
- Cali
- Plush
- Ridge
- Speedway
- Stardust
- Grade 2 Cathedral
- COM
- Orbit
- Pixie
- Sedona
- Shenanigans
- Spectrum
- Strand
- Tranquility
- Twilight

- Grade 3 Boardwalk
- COL
- Jacks
- Pop Rocks
- Grade 4 Big City
- Bumble
- Connect Four
- Echo
- Silvertex
- Grade 6 Essence/Ultraleather
- Flock
- Scribe

- Grade 7 Brisa
- Brisa Distressed
- Promessa
- Silica
- Grade L7 Davenport
- Grade L8 Showcase

PLASTIC COLORS

- P02 Red
- P03 Blue
- P06 Pebble
- P07 Currant
- P08 Marshmallow
- P10 Black
- P11 Blueberry
- P12 Lemon
- P14 Lime
- P19 Brownie

FRAME COLORS

- 462 Cinder
- 501 Platinum Metallic

CASTERS

- STD Hard (standard)
- C4 Soft (add \$24 list per chair)

GLIDES

- STD Standard
- C30 Soft (add \$14 list per chair)

To You In 10 DAYS ...or Less
 Shaded model numbers are available on our "To You in 10 Days or Less" Quick Delivery program and will be delivered within 10 days.

To Order, Specify:

1. Model Number
 2. Back Plastic Color
 3. Seat Fabric Grade/Cover Number (when applicable)
 4. Seat Plastic Color (when applicable)
 5. Frame Color
 6. Casters (mobile models only)
 7. Glides (static models only)
- See page 65 for Cinch options

Plastic Stacker Armless



Plastic Seat



Upholstered Seat

Model Grade / List Price No.

Quick Delivery Models: QN45APR, QN45AP, QN45AUR, QN45AU

N45APR	Package of 1, Plastic	\$	241								
N45AP	Package of 4, Plastic		732								
				1	2/COM	3/COL	4	6	7	L7	L8
N45AUR	Package of 1, Upholstered	\$	404	411	415	420	437	450	514	534	
N45AU	Package of 4, Upholstered		1227	1256	1270	1291	1353	1405	1653	1733	

Dimensions

Width	21¼	Seat Height	18	Back Height	16½	Weight (1)	18
Depth	23¾	Seat Depth	17¾	Back Width	18½	Cubic Ft. (1)	13
Height	31	Seat Width	17¾			Weight (4)	65
						Cubic Ft. (4)	20

- Ordering (1) of model N45AP or N45AU will result in (1) carton being shipped, containing (4) chairs
- Pricing, weight and cubic ft. shown are per carton
- Each carton must have the same options
- Platinum Metallic frame option available for a \$26 list upcharge per chair (\$104 for package of 4)
- Soft glide option available for a \$14 list upcharge per chair (\$56 for package of 4)

Plastic Stacker Mobile, Armless

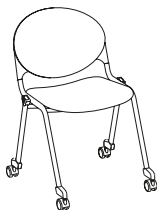

Plastic Seat

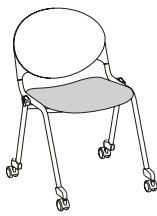

Upholstered Seat

Quick Delivery Model: QN45BPR, QN45BP, QN45BUR, QN45BU

N45BPR	Package of 1, Plastic	\$	325								
N45BP	Package of 4, Plastic		988								
				1	2/COM	3/COL	4	6	7	L7	L8
N45BUR	Package of 1, Upholstered	\$	489	496	500	505	522	535	599	619	
N45BU	Package of 4, Upholstered		1483	1512	1526	1547	1609	1661	1909	1989	

Dimensions

Width	21¼	Seat Height	18	Back Height	16½	Weight (1)	18
Depth	25¼	Seat Depth	17¾	Back Width	18½	Cubic Ft. (1)	13
Height	31	Seat Width	17¾			Weight (4)	72
						Cubic Ft. (4)	20

- Ordering (1) of model N45BP or N45BU will result in (1) carton being shipped, containing (4) chairs
- Pricing, weight and cubic ft. shown are per carton
- Caster model not recommended for ganging
- Platinum Metallic frame option available for a \$26 list upcharge per chair (\$104 for package of 4)
- Soft caster option available for a \$24 list upcharge per chair (\$96 for package of 4)

Arms

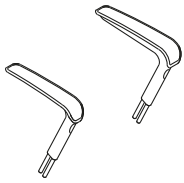

Model No.

Grade / List Price

N45MAR	Platinum Metallic	\$ 143	Package of 1 Pair
N45MA	Platinum Metallic	467	Package of 4 Pairs
N45MMR	Cinder	117	Package of 1 Pair
N45MM	Cinder	350	Package of 4 Pairs

Dimensions (Installed on Chair)

Width	22½	Seat Height	18	Seat Width	17¾	Weight (1)	5
Depth	25¼	Seat Depth	17¾	Arm Height	26	Cubic Ft. (1)	0.5
Height	31					Weight (4)	12
						Cubic Ft. (4)	0.73

- Ordering (1) of model N45MA or N45MM will result in (1) carton being shipped, containing (4) arm sets
- Pricing, weight and cubic ft. shown are per carton
- For use with Cinch stacking chair

Standard Tablet Arm

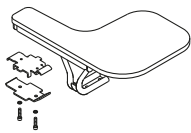

N45RTR	Right-Handed (as seated)	\$ 170	Package of 1
N45RT	Right-Handed (as seated)	510	Package of 4
N45LTR	Left-Handed (as seated)	170	Package of 1
N45LT	Left-Handed (as seated)	510	Package of 4

Dimensions (Installed on Chair)

Width	25	Seat Height	18	Seat Width	17¾	Weight (1)	11
Depth	28	Seat Depth	17¾	Arm Height	28½	Cubic Ft. (1)	0.81
Height	31					Weight (4)	44
						Cubic Ft. (4)	2.5

- Ordering (1) of model N45RT or N45LT will result in (1) carton being shipped, containing (4) tablets
- P-shaped writing surface is 14¼" W x 10½" D
- Pricing, weight and cubic ft. shown are per carton
- Available in black only
- For use with Cinch stacking chair

Oversized Tablet Arm

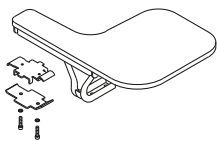

N45RT2R	Right-Handed (as seated)	\$ 254	Package of 1
N45RT2	Right-Handed (as seated)	770	Package of 4
N45LT2R	Left-Handed (as seated)	254	Package of 1
N45LT2	Left-Handed (as seated)	770	Package of 4

Dimensions (Installed on Chair)

Width	25	Seat Height	18	Seat Width	17¾	Weight (1)	13
Depth	29½	Seat Depth	17¾	Arm Height	28½	Cubic Ft. (1)	0.81
Height	31					Weight (4)	61
						Cubic Ft. (4)	2.5

- Ordering (1) of model N45RT2 or N45LT2 will result in (1) carton being shipped, containing (4) tablets
- Oversized P-shaped writing surface is 16½" W x 12" D
- Pricing, weight and cubic ft. shown are per carton
- Available in black only
- For use with Cinch stacking chair

Bookrack

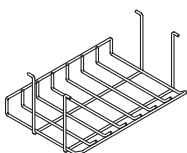

N45BKR	Black	\$ 79	Package of 1
N45BK	Black	234	Package of 4

Dimensions

Width	17	Weight (1)	4
Depth	12¾	Cubic Ft. (1)	0.5
Height	7¾	Weight (4)	10
		Cubic Ft. (4)	1.5

- Ordering (1) of model N45BK will result in (1) carton being shipped, containing (4) bookracks
- Pricing, weight and cubic ft. shown are per carton
- For use with Cinch stacking chair

To You In 10 DAYS ...or Less Shaded model numbers are available on our "To You in 10 Days or Less" Quick Delivery program and will be delivered within 10 days.

To Order, Specify:

1. Model Number
 2. Back Plastic Color
 3. Seat Fabric Grade/Cover Number (when applicable)
 4. Seat Plastic Color (when applicable)
 5. Frame Color
 6. Glides (static models only)
- See page 65 for Cinch options

Plastic Barstool

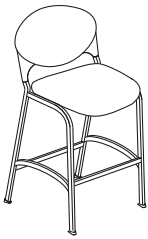

Model No. **Grade / List Price**

Quick Delivery Model: QN45CP

N45CP **\$ 439**

Dimensions

Width	19¼	Seat Height	29½	Back Height	16½	Weight	20
Depth	24	Seat Depth	17¾	Back Width	18½	Cubic Ft.	20.4
Height	43½	Seat Width	17¾				

- Ordered and shipped (1) chair per carton
- Platinum Metallic frame option available for a \$32 list upcharge
- Barstools cannot be used with arms, tablet arms, bookracks or ganging brackets
- Barstools are non-stacking
- Soft glide option available for a \$14 list upcharge

Plastic Barstool Upholstered Seat

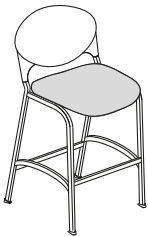

Quick Delivery Model: QN45CU

		1	2/COM	3/COL	4	6	7	L7	L8
N45CU	\$	561	568	572	577	594	607	671	691

Dimensions

Width	19¼	Seat Height	29¾	Back Height	16½	Weight	20
Depth	24	Seat Depth	17¾	Back Width	18½	Cubic Ft.	20.4
Height	43½	Seat Width	17¾				

- Ordered and shipped (1) chair per carton
- Platinum Metallic frame option available for a \$32 list upcharge
- Barstools cannot be used with arms, tablet arms, bookracks or ganging brackets
- Barstools are non-stacking
- Soft glide option available for a \$14 list upcharge

Ganging Bracket

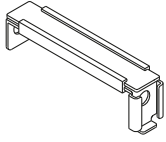

Model No.

Grade / List Price

N45GB	Black	\$	245	Package of 20
--------------	-------	----	------------	----------------------

Dimensions

Width	4½	Weight	6
Depth	1	Cubic Ft.	0.10
Height	1⅝		

- For use with non-mobile plastic stacker
- Only required if ganging arm or tablet models or in case additional space is needed between armless models
- Ordered and shipped (20) ganging brackets per carton
- Pricing, weight and cubic ft. shown are per carton
- Ordering (1) of model N45GB will result in (1) carton being shipped, containing (20) ganging brackets

Transport Dolly

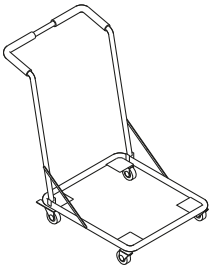

N45TD	Black	\$	436
--------------	-------	----	------------

Dimensions

Width	25¾	Weight	31
Depth	35½	Cubic Ft.	4.28
Height	38¾		

- For use with non-mobile plastic stacker
- Transport dolly is not needed for the mobile stacker; the weight of the stacked chairs will engage the casters for easy transport

CINCH TASK PRODUCT SPECIFICATIONS

45 Series

FRAME CONSTRUCTION

- Frame is made of 1¼" x ⅝" thick steel for strength and durability
- Seat pan frame constructed of 10-gauge thick steel
- Back support brackets utilize ⅝" thick steel plates

SEAT AND BACK CONSTRUCTION

- Contoured, injection molded polypropylene seat and back
- Seat and backrest are attached to the frame with screws

UPHOLSTERED SEAT CONSTRUCTION

- ½" foam

ARM REST

- Die-cast aluminum arm upright covered with an (ABS) black plastic arm cap

CONTROL

- Swivel control
- The pneumatic gas cylinder lift allows the seat to raise and lower

BASE AND CASTERS

- Nylon five-prong base features glass filled nylon for beauty and a long life
- Black, hard double wheel casters, which work on multiple surfaces, are standard
- Black, soft double wheel casters are available for use on hard floors; upcharge applies to this option
- Platinum Metallic option features a cast aluminum base

FINISH

- Cinder and Platinum Metallic frames are finished with electrostatically baked-on powder coat paint

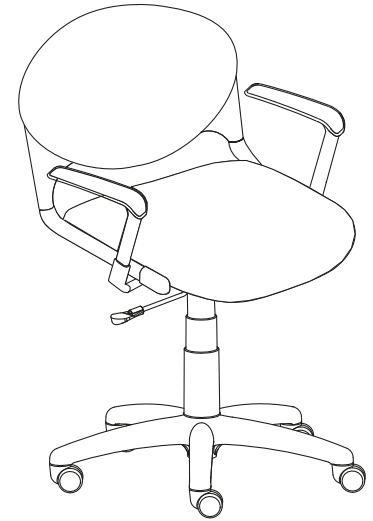

All Cinch Task models may be ordered to meet TB133 fire code.

To order seating to meet the TB133 fire code, specify an "F" at the end of the model number (Ex: N45HUF).

Reference pages 465-493 for TB133 Fabric Matrix and pricing.

Please consult customer service for applicable Arc-Com, COM, Maharam, Momentum, Stinson or Ultrafabrics fabric.

FABRICS

- Grade 1 American Graffiti
- Cali
- Plush
- Ridge
- Speedway
- Stardust
- Grade 2 Cathedral
- COM
- Orbit
- Pixie
- Sedona
- Shenanigans
- Spectrum
- Strand
- Tranquility
- Twilight

- Grade 3 Boardwalk
- COL
- Jacks
- Pop Rocks
- Grade 4 Big City
- Bumble
- Connect Four
- Echo
- Silvertex
- Grade 6 Essence/Ultraleather
- Flock
- Scribe

- Grade 7 Brisa
- Brisa Distressed
- Promessa
- Silica
- Grade L7 Davenport
- Grade L8 Showcase

PLASTIC COLORS

- P02 Red
- P03 Blue
- P06 Pebble
- P07 Currant
- P08 Marshmallow
- P10 Black
- P11 Blueberry
- P12 Lemon
- P14 Lime
- P19 Brownie

FRAME COLORS

- 462 Cinder
- 501 Platinum Metallic

CASTERS

- C15 Hard (standard)
- C2 Soft (add \$24 list)

To You In 10 DAYS ...or Less
 Shaded model numbers are available on our "To You in 10 Days or Less" Quick Delivery program and will be delivered within 10 days.

To Order, Specify:

1. Model Number
2. Back Plastic Color
3. Seat Fabric Grade/Cover Number (when applicable)
4. Seat Plastic Color (when applicable)
5. Frame Color
6. Casters

• See page 71 for Cinch options

Plastic Task

Model No. Grade / List Price

Quick Delivery Models: QN45HP, QN45HPL

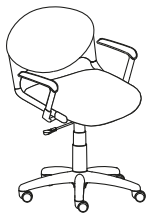

Arms



Armless

N45HP	Arms	\$	574
N45HPL	Armless		465

Dimensions

Arm Width	24¼	Seat Height	15¼-20¼	Arm Height	23¼-28¼	Arm Weight	31
Armless Width	24¼	Seat Depth	17¾	Back Height	16½	Armless Weight	27
Depth	23½	Seat Width	17¾	Back Width	18½	Cubic Ft.	14.3
Height	29¾-34¾						

• Platinum Metallic frame option with cast aluminum base available for a \$100 list upcharge

Plastic Task Upholstered Seat

Quick Delivery Models: QN45HU, QN45HUL



Arms



Armless

		1	2/COM	3/COL	4	6	7	L7	L8	
N45HU	Arms	\$	694	701	705	710	727	740	804	824
N45HUL	Armless		585	592	596	601	618	631	695	715

Dimensions

Arm Width	24¼	Seat Height	15¼-20¼	Arm Height	23¼-28¼	Arm Weight	31
Armless Width	24¼	Seat Depth	17¾	Back Height	16½	Armless Weight	27
Depth	23½	Seat Width	17¾	Back Width	18½	Cubic Ft.	14.3
Height	29¾-34¾						

• Platinum Metallic frame option with cast aluminum base available for a \$100 list upcharge

Plastic Task Stool



Arms



Armless

Model No.

Grade / List Price

Quick Delivery Models: QN45JP, QN45JPL

N45JP	Arms	\$ 694
N45JPL	Armless	585

Dimensions

Arm Width	24¼	Seat Height	21¾-31¾	Arm Height	29¾-39¾	Arm Weight	36
Armless Width	24¼	Seat Depth	17¾	Back Height	16½	Armless Weight	41
Depth	23½	Seat Width	17¾	Back Width	18½	Cubic Ft.	16.7
Height	36½-46½						

- Platinum Metallic frame option with cast aluminum base available for a \$100 list upcharge

Plastic Task Stool Upholstered Seat



Arms



Armless

Quick Delivery Models: QN45JU, QN45JUL

		1	2/COM	3/COL	4	6	7	L7	L8
N45JU	Arms	\$ 814	821	825	830	847	860	924	944
N45JUL	Armless	705	712	716	721	738	751	815	835

Dimensions

Arm Width	24¼	Seat Height	21¾-31¾	Arm Height	29¾-39¾	Arm Weight	36
Armless Width	24¼	Seat Depth	17¾	Back Height	16½	Armless Weight	41
Depth	23½	Seat Width	17¾	Back Width	18½	Cubic Ft.	16.7
Height	36½-46½						

- Platinum Metallic frame option with cast aluminum base available for a \$100 list upcharge

Cinch

CINCH BEAM PRODUCT SPECIFICATIONS

45 Series

BEAM FRAME CONSTRUCTION

- Frame features 1½" x 3¼" rectangular steel tube for strength and durability
- Leg uprights feature 1½" x 3¼" oval steel tube

CHAIR KIT CONSTRUCTION

- Frame is made of 1¼" x 5⁄8" thick steel for strength and durability
- Cross members are constructed of ¾" x 15-gauge thick steel
- Back support brackets utilize 5⁄16" thick steel plates

SEAT AND BACK CONSTRUCTION

- Contoured, injection molded polypropylene seat and back
- Seat features metal attachment plate for strength and durability
- Backrest is attached to the frame with screws

UPHOLSTERED SEAT CONSTRUCTION

- ½" foam

ARM REST

- Die-cast aluminum arm upright covered with a black urethane arm cap

TABLET ARMS

- ¾" thick black laminated MDF hinged surface mounted on die-cast aluminum V-shaped arm rest
- 21" W x 13½" D writing surface
- Available as right-handed only

TABLE

- ¾" thick black laminated MDF surface
- 17¾" x 17¾" writing surface

GLIDES

- Durable hard black nylon adjustable glides are standard
- Soft glides are available for an additional upcharge

FINISH

- Cinder and Platinum Metallic frames are finished with electrostatically baked-on powder coat paint

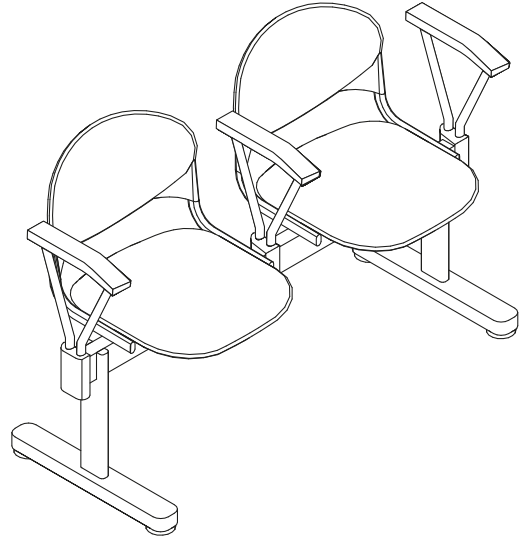

All Cinch Beam models may be ordered to meet TB133 fire code.

To order seating to meet the TB133 fire code, specify an "F" at the end of the model number (Ex: N45U1F).

Reference pages 465-493 for TB133 Fabric Matrix and pricing.

Please consult customer service for applicable Arc-Com, COM, Maharam, Momentum, Stinson or Ultrafabrics fabric.

FABRICS

- Grade 1 American Graffiti
- Cali
- Plush
- Ridge
- Speedway
- Stardust
- Grade 2 Cathedral
- COM
- Orbit
- Pixie
- Sedona
- Shenanigans
- Spectrum
- Strand
- Tranquility
- Twilight

- Grade 3 Boardwalk
- COL
- Jacks
- Pop Rocks
- Grade 4 Big City
- Bumble
- Connect Four
- Echo
- Silververtex
- Grade 6 Essence/Ultraleather
- Flock
- Scribe

- Grade 7 Brisa
- Brisa Distressed
- Promessa
- Silica
- Grade L7 Davenport
- Grade L8 Showcase

PLASTIC COLORS

- P02 Red
- P03 Blue
- P06 Pebble
- P07 Currant
- P08 Marshmallow
- P10 Black
- P11 Blueberry
- P12 Lemon
- P14 Lime
- P19 Brownie

FRAME COLORS

- 462 Cinder
- 501 Platinum Metallic

To You In
10 DAYS
...or Less

Shaded model numbers are available on our "To You in 10 Days or Less" Quick Delivery program and will be delivered within 10 days.

To Order, Specify:

1. Model Number
- See page 75 for Cinch options

2-Seat Beam

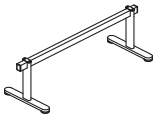

Model No. Grade / List Price

N45K2B	Black	\$ 492
N45K2P	Platinum Metallic	515

Dimensions

Width	48	Weight	23.5
Depth	23	Cubic Ft.	1.25

- Beams can be configured by using any combination of chair, table, tablet and arm kits

3-Seat Beam

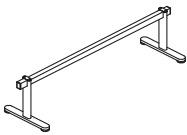

N45K3B	Black	\$ 711
N45K3P	Platinum Metallic	744

Dimensions

Width	72	Weight	25
Depth	23	Cubic Ft.	1.35

- Beams can be configured by using any combination of chair, table, tablet and arm kits

4-Seat Beam

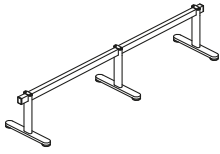

Model No.

Grade / List Price

N45K4B	Black	\$ 929
N45K4P	Platinum Metallic	962

Dimensions

Width	96	Weight	35
Depth	23	Cubic Ft.	2.21

- Beams can be configured by using any combination of chair, table, tablet and arm kits

5-Seat Beam

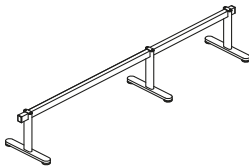

N45K5B	Black	\$ 1147
N45K5P	Platinum Metallic	1180

Dimensions

Width	120	Weight	37
Depth	23	Cubic Ft.	2.32

- Beams can be configured by using any combination of chair, table, tablet and arm kits

To You In 10 DAYS ...or Less
 Shaded model numbers are available on our "To You in 10 Days or Less" Quick Delivery program and will be delivered within 10 days.

To Order, Specify:

1. Model Number
2. Back Plastic Color
3. Seat Fabric Grade/Cover Number (when applicable)
4. Seat Plastic Color (when applicable)
5. Frame Color

• See page 75 for Cinch options

Beam Chair Kits Plastic

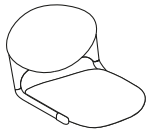

Model No. Grade / List Price

Quick Delivery Models: QN45P1, QN45P2, QN45P3

N45P1	1 - Chair Kit, Plastic	\$ 300
N45P2	2 - Chair Kit, Plastic	602
N45P3	3 - Chair Kit, Plastic	902

Dimensions (Installed on Beam)

Height	32½	Seat Height	18¼	Back Height	16½	1 Chair Kit	
Depth	23	Seat Depth	17¾	Back Width	18½	Weight	18
		Seat Width	17¾			Cubic Ft.	6.7
						2 Chair Kit	
						Weight	33
						Cubic Ft.	7.7
						3 Chair Kit	
						Weight	47
						Cubic Ft.	8.8

- Platinum Metallic frame option available for a \$26 list upcharge, per chair; N45P1 = \$26, N45P2 = \$52, N45P3 = \$78
- Chairs attach to the beam, hardware included

Beam Chair Kits Upholstered

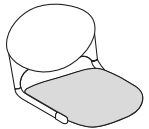

Quick Delivery Models: QN45U1, QN45U2, QN45U3

		1	2/COM	3/COL	4	6	7	L7	L8
N45U1	1 - Chair Kit, Upholstered	\$ 383	390	394	399	416	429	493	513
N45U2	2 - Chair Kit, Upholstered	765	779	786	797	828	854	978	1018
N45U3	3 - Chair Kit, Upholstered	1147	1168	1179	1195	1242	1281	1467	1526

Dimensions (Installed on Beam)

Height	32½	Seat Height	18¼	Back Height	16½	1 Chair Kit	
Depth	23	Seat Depth	17¾	Back Width	18½	Weight	18
		Seat Width	17¾			Cubic Ft.	6.7
						2 Chair Kit	
						Weight	33
						Cubic Ft.	7.7
						3 Chair Kit	
						Weight	47
						Cubic Ft.	8.8

- Platinum Metallic frame option available for a \$26 list upcharge, per chair; N45U1 = \$26, N45U2 = \$52, N45U3 = \$78
- Chairs attach to the beam, hardware included

Beam Arm Kit

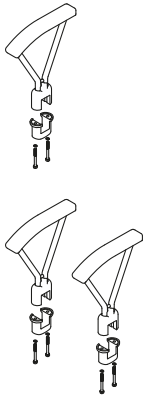

Model No.

Grade / List Price

N45MBB	Black, Package of 1	\$ 137
N45MCB	Black, Package of 2	274
N45MBP	Platinum Metallic, Package of 1	171
N45MCP	Platinum Metallic, Package of 2	307

Dimensions (Installed on Beam)

Arm Height 26¾

1 Arm Kit
Weight 6
Cubic Ft. 0.50
2 Arm Kit
Weight 10
Cubic Ft. 0.60

- Arms attach to the beam with U-bracket, included in kit

Beam Tablet Kit

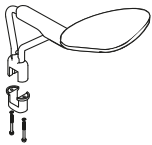

N45TB	Black	\$ 191
N45TP	Platinum Metallic	225

Dimensions (Installed on Beam)

Tablet Height 28¾

Weight 11
Cubic Ft. 0.81

- Tablet folds down to side of arm when not in use
- Right-handed tablet only
- Tablet arms attach to the beam with U-bracket, included in kit
- Tablet writing surface is 21" W x 13½" D

Beam Table Kit

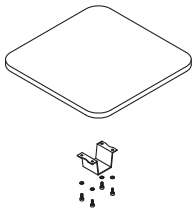

N45TAB	Black	\$ 300
N45TAP	Platinum Metallic	334

Dimensions (Installed on Beam)

Table Height 18½
Table Width 17¾
Table Depth 17¾

Weight 20
Cubic Ft. 1.12

- Tables attach to the beam with U-bracket, included in kit

Cinch Beam Configurations

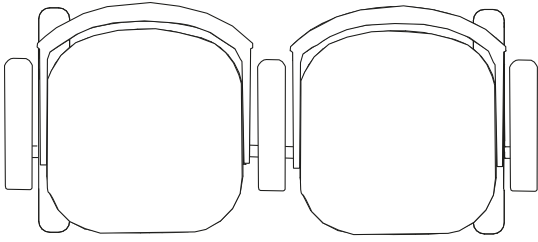

- 1) N45K2B 2-Seat Beam
- 1) N45P2 2-Chair Kit - Plastic
- 1) N45MBB Beam Arm Kit - package of 1
- 1) N45MCB Beam Arm Kit - package of 2

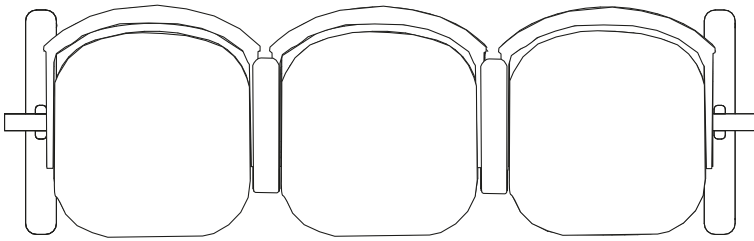

- 1) N45K3B 3-Seat Beam
- 1) N45P3 3-Chair Kit - Plastic
- 1) N45MCB Beam Arm Kit - package of 2

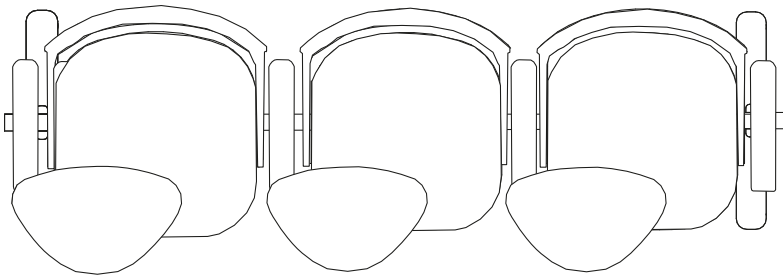

- 1) N45K3B 3-Seat Beam
- 1) N45P3 3-Chair Kit - Plastic
- 3) N45TB Beam Tablet Kit (right-handed only)
- 1) N45MBB Beam Arm Kit - package of 1

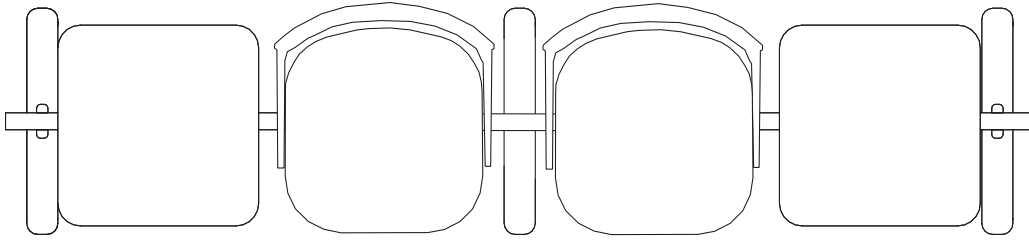

- 1) N45K4B 4-Seat Beam
- 1) N45P2 2-Chair Kit - Plastic
- 2) N45TAB Beam Table Kit

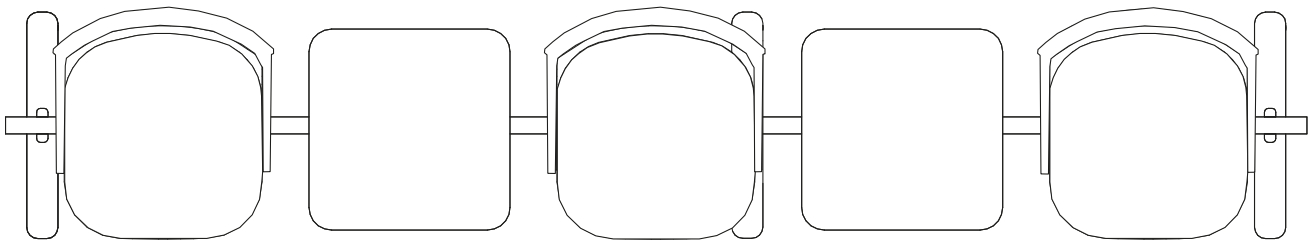

- 1) N45K5B 5-Seat Beam
- 1) N45P1 1-Chair Kit - Plastic
- 1) N45P2 2-Chair Kit - Plastic
- 2) N45TAB Beam Table Kit

Confide®

Confide

CONFIDE PRODUCT SPECIFICATIONS—LOUNGE, FREESTANDING TABLES 78 Series

LOUNGE WITH UPHOLSTERED BACK PANELS

FRAME CONSTRUCTION

- Interior frame is constructed of plywood with tenon joints that are glued and stapled for maximum joint stability
- Welded leg assembly is screwed within the arm frame assembly
- 12-gauge back brackets are attached to the frame with wood screws

FULLY UPHOLSTERED BACK CONSTRUCTION

- 1" of high grade polyurethane foam covers a plywood back panel

EXPOSED WOOD BACK CONSTRUCTION

- 1" of high grade polyurethane foam covers a plywood back panel

SEAT CONSTRUCTION

- 3¼" of high grade polyurethane foam covers a plywood seat panel
- Easy clean wipe out feature

ARMS

- ¾" of high grade polyurethane foam covers a plywood constructed arm frame

CONTRASTING FABRIC

- Contrasting fabric available on all models

LEGS

- Front and back legs and cross member are made from 7/8" x 1¼" 16-gauge elliptical tubular steel. Cross member is joined to the front and back leg with metal inert gas (MIG) welds
- Wall saving design feature

TABLET ARM

- ¾" thick MDF core with black thermofoil or ¾" plywood core with maple veneer
- Attached with ¼" steel base plate and screws that mount over ¾" diameter insert rod and fits into structure of arm
- Allows for 360° swivel and writing surface of 14" W x 9½" D

GLIDES

- Front legs feature a 1" adjustable leveling glide
- Back legs feature a 1" adjustable 1" swivel leveling glide
- Soft glides are available for an additional upcharge

ARM CAPS

- Available with black protective polyurethane or decorative solid hard maple
- Arm cap is not an option on arm where tablet is specified
- Arm caps cannot be retrofitted to non-arm cap models
- Arm caps are field serviceable

FINISHES

- Cinder, Platinum Metallic and Satin Nickel Metallic frames are finished with an electrostatic baked-on powder coat
- Wood components feature a catalyzed top coat that resists denting, peeling and reactions to chemicals
- Can be cleaned with a damp cloth
- Features our silver ion antimicrobial finish which inhibits the growth of bacteria and microbes

WOOD SPECIES

- Hard maple

TABLES

FRAME CONSTRUCTION

- Table frame is made from 7/8" x 1¼" 16-gauge elliptical tubular steel
- Cross members are made from 7/8" 16-gauge round tubular steel
- Cross members are joined to the U-bent side members with metal inert gas (MIG) welds

TOPS

- Veneer models feature a ¾" molded laminated HDF core slipmatched maple veneer
- Laminate models feature a ¾" molded laminated HDF core with laminate (HPL) top

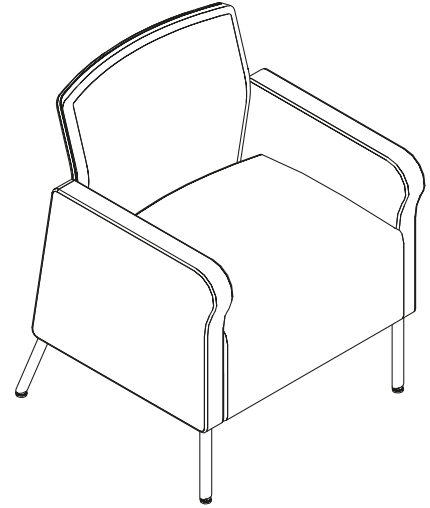

All Confide Lounge models may be ordered to meet TB133 fire code.

To order seating to meet the TB133 fire code, specify an "F" at the end of the model number (Ex: N78LAUF).

Reference pages 465-493 for TB133 Fabric Matrix and pricing.

Please consult customer service for applicable Arc-Com, COM, Maharam, Momentum, Stinson or Ultrafabrics fabric.



For comprehensive sustainability information that includes LEED® point contribution, visit NationalOfficeFurniture.ecoScorecard.com.

FABRICS

Grade 1	American Graffiti
	Cali
	Plush
	Ridge
	Speedway
	Stardust
Grade 2	Cathedral
	COM
	Orbit
	Pixie
	Sedona
	Shenanigans
	Spectrum
	Strand
	Tranquility
	Twilight

Grade 3	Boardwalk
	COL
	Jacks
	Pop Rocks
Grade 4	Big City
	Bumble
	Connect Four
	Echo
	Silvertex
Grade 6	Essence/Ultraleather
	Flock
	Scribe

Grade 7	Brisa
	Brisa Distressed
	Promessa
	Silica
Grade L7	Davenport
Grade L8	Showcase

TABLET ARM

T	Thermofoil, Black
W405	Wood, Designer White
W462	Wood, Cinder
W792	Wood, Sable
W793	Wood, Acorn
WAC	Wood, Autumn
WCL	Wood, Caramel
WCW	Wood, Cordovan
WDW	Wood, Judicial
WHN	Wood, Honey
WIM	Wood, Brighton
WMC	Wood, Amber
WMH	Wood, Mocha
WNM	Wood, Natural
WTF	Wood, Truffle

FINISHES

IM	Brighton	CW	Cordovan
NM	Natural	DW	Judicial
HN	Honey	MH	Mocha
CL	Caramel	405	Designer White
TF	Truffle	462	Cinder
AC	Autumn	792	Sable
MC	Amber	793	Acorn

LAMINATES

IM	Brighton	MH	Mocha
NM	Natural	405	Designer White
HN2	Honey 2	462	Cinder
CL	Caramel	791NM	Palisander/Natural
TF	Truffle	791HN	Palisander/Honey
AC2	Autumn 2	791MH	Palisander/Mocha
MC	Amber	792	Sable
CW	Cordovan	793	Acorn
DW	Judicial		

ARM CAP

(\$80 upcharge per polyurethane arm cap,
\$135 upcharge per wood arm cap)

CAP_U	Polyurethane
CAP_IM	Brighton
CAP_NM	Natural
CAP_HN	Honey
CAP_CL	Caramel
CAP_TF	Truffle
CAP_AC	Autumn
CAP_MC	Amber
CAP_CW	Cordovan
CAP_DW	Judicial
CAP_MH	Mocha
CAP_405	Designer White
CAP_462	Cinder
CAP_792	Sable
CAP_793	Acorn
X	No Cap

LEG COLORS

462	Cinder
501	Platinum Metallic
503	Satin Nickel Metallic

GLIDES

STD	Standard
C10	Soft (add \$26 list)

Confide

To Order, Specify:

1. Model Number
2. Fabric Grade Number
3. Fabric Cover Number
4. Tablet and Finish (when applicable)
5. Arm Cap (when applicable)
6. Wood Back Finish Color (when applicable)
7. Leg Color

• See page 85 for Confide options

One Seat Lounge



Upholstered

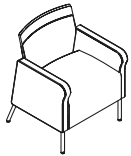

Wood Back



Arm Caps

Model No.

Grade / List Price

		1	2/COM	3/COL	4	6	7	L7	L8
N78LAU	Upholstered Back	\$ 1970	2044	2079	2130	2290	2421	3052	3253
N78LAW	Wood Back	2110	2179	2212	2260	2410	2533	3124	3313

Dimensions

Width	27¼	Seat Height	18½	Arm Height	26	Weight	70
Depth	26¾	Seat Depth	19	Back Height	33¾	Cubic Ft.	21.8
Height	33¾	Seat Width	21½	Back Width	21½		

- Contrasting fabric option – specify X (i.e., N78LAUX); see below. For list pricing, use your electronic specification tool or contact customer service
- Soft glide option available for a \$26 list upcharge

To Order Contrasting Fabric, Specify:

1. Model Number plus “X”
2. Back Fabric Grade Number/Cover Number
3. Extreme Back Fabric Grade Number/Cover Number
4. Seat Fabric Grade Number/Cover Number
5. Arm Fabric Grade Number/Cover Number
6. Arm Cap (when applicable)
7. Wood Back Finish Color (when applicable)
8. Leg Color

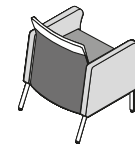
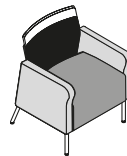
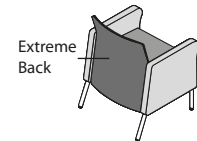
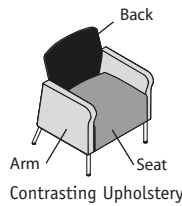

One Seat Lounge with Tablet



Upholstered



Wood Back



Tablet and Arm Cap

Model No.

Grade / List Price

		1	2/COM	3/COL	4	6	7	L7	L8
N78LAUR	Upholstered Back Tablet Right Arm	\$ 2223	2297	2332	2383	2543	2674	3305	3506
N78LAUL	Upholstered Back Tablet Left Arm	2223	2297	2332	2383	2543	2674	3305	3506
N78LAWR	Wood Back Tablet Right Arm	2364	2433	2466	2514	2664	2787	3378	3567
N78LAWL	Wood Back Tablet Left Arm	2364	2433	2466	2514	2664	2787	3378	3567

Dimensions

Width	27¼	Seat Height	18½	Arm Height	26	Weight	77
Depth	26¾	Seat Depth	19	Back Height	33¾	Cubic Ft.	21.8
Height	33¾	Seat Width	21½	Back Width	21½		

- Contrasting fabric option – specify X (i.e., N78LAURX); see below. For list pricing, use your electronic specification tool or contact customer service
- Tablet available in black thermofoil or veneer
- Veneer tablet arm available in all wood finishes and Cinder and Designer White paint
- Arm cap is not an option on arm where tablet is specified
- Soft glide option available for a \$26 list upcharge

To Order Contrasting Fabric, Specify:

1. Model Number plus "X"
2. Back Fabric Grade Number/Cover Number
3. Extreme Back Fabric Grade Number/Cover Number
4. Seat Fabric Grade Number/Cover Number
5. Arm Fabric Grade Number/Cover Number
6. Tablet and Finish (when applicable)
7. Arm Cap (when applicable)
8. Wood Back Finish Color (when applicable)
9. Leg Color

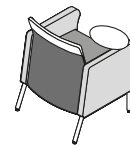
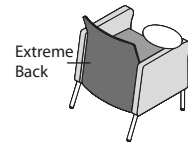
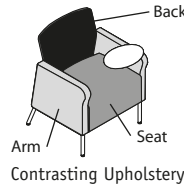

To Order, Specify:

1. Model Number
2. Fabric Grade Number
3. Fabric Cover Number
4. Tablet and Finish (when applicable)
5. Arm Cap (when applicable)
6. Wood Back Finish Color (when applicable)
7. Leg Color

• See page 85 for Confide options

Two Seat Lounge

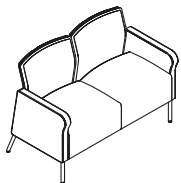

Upholstered

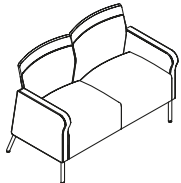

Wood Back



Arm Caps

Model No.

Grade / List Price

		1	2/COM	3/COL	4	6	7	L7	L8
N78LBU	Upholstered Back	\$ 2560	2668	2720	2795	3030	3223	4149	4445
N78LBW	Wood Back	2842	2943	2992	3062	3282	3462	4329	4606

Dimensions

Width	49	Seat Height	18½	Arm Height	26	Weight	105
Depth	26¾	Seat Depth	19	Back Height	33¾	Cubic Ft.	37.5
Height	33¾	Seat Width	21½	Back Width	21½		

- Contrasting fabric option – specify X (i.e., N78LBUX); see below. For list pricing, use your electronic specification tool or contact customer service
- Soft glide option available for a \$26 list upcharge

To Order Contrasting Fabric, Specify:

1. Model Number plus “X”
2. Back Fabric Grade Number/Cover Number
3. Extreme Back Fabric Grade Number/Cover Number
4. Seat Fabric Grade Number/Cover Number
5. Arm Fabric Grade Number/Cover Number
6. Arm Cap (when applicable)
7. Wood Back Finish Color (when applicable)
8. Leg Color

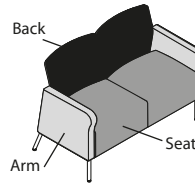

Contrasting Upholstery

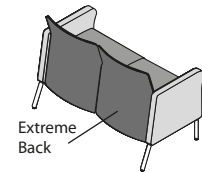

Contrasting Upholstery Back View

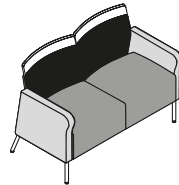

Contrasting Upholstery Wood Back

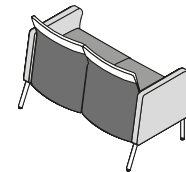

Contrasting Upholstery Wood Back Back View

Two Seat Lounge with Tablet

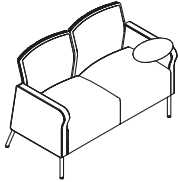

Upholstered

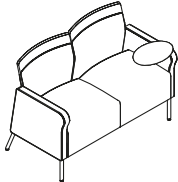

Wood Back

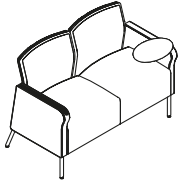

Tablet and Arm Cap

Model No.

Grade / List Price

		1	2/COM	3/COL	4	6	7	L7	L8
N78LBUR	Upholstered Back Tablet Right Arm	\$ 2814	2922	2974	3049	3284	3477	4403	4699
N78LBUL	Upholstered Back Tablet Left Arm	2814	2922	2974	3049	3284	3477	4403	4699
N78LBUB	Upholstered Back Tablet Both Arms	3067	3175	3227	3302	3537	3730	4656	4952
N78LBWR	Wood Back Tablet Right Arm	3096	3197	3246	3316	3536	3716	4583	4860
N78LBWL	Wood Back Tablet Left Arm	3096	3197	3246	3316	3536	3716	4583	4860
N78LBWB	Wood Back Tablet Both Arms	3349	3450	3499	3569	3789	3969	4836	5113

Dimensions

Width	49	Seat Height	18½	Arm Height	26	Weight	119
Depth	26%	Seat Depth	19	Back Height	33%	Cubic Ft.	37.5
Height	33%	Seat Width	21½	Back Width	21½		

- Contrasting fabric option – specify X (i.e., N78LBURX); see below. For list pricing, use your electronic specification tool or contact customer service
- Tablet available in black thermofoil or veneer
- Veneer tablet arm available in all wood finishes and Cinder and Designer White paint
- Arm cap is not an option on arm where tablet is specified
- Soft glide option available for a \$26 list upcharge

To Order Contrasting Fabric, Specify:

1. Model Number plus "X"
2. Back Fabric Grade Number/Cover Number
3. Extreme Back Fabric Grade Number/Cover Number
4. Seat Fabric Grade Number/Cover Number
5. Arm Fabric Grade Number/Cover Number
6. Tablet and Finish (when applicable)
7. Arm Cap (when applicable)
8. Wood Back Finish Color (when applicable)
9. Leg Color

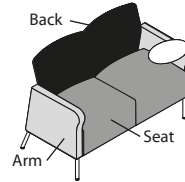

Contrasting Upholstery

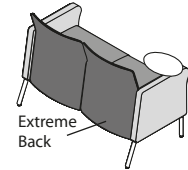

Contrasting Upholstery Back View

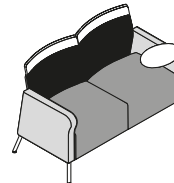

Contrasting Upholstery Wood Back

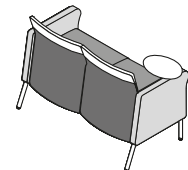

Contrasting Upholstery Wood Back Back View

Confide

To Order, Specify:

1. Model Number
2. Fabric Grade Number
3. Fabric Cover Number
4. Tablet and Finish (when applicable)
5. Arm Cap (when applicable)
6. Wood Back Finish Color (when applicable)
7. Leg Color

• See page 85 for Confide options

Three Seat Lounge

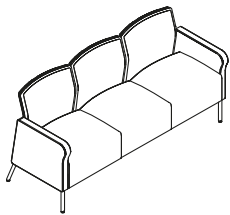

Upholstered

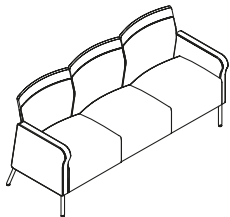

Wood Back

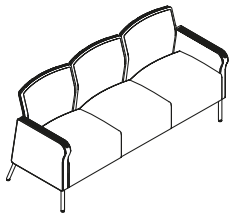

Arm Caps

Model No.

Grade / List Price

		1	2/COM	3/COL	4	6	7	L7	L8
N78LCU	Upholstered Back	\$ 3208	3355	3426	3528	3848	4110	5371	5774
N78LCW	Wood Back	3675	3815	3882	3980	4285	4535	5737	6121

Dimensions

Width	71	Seat Height	18½	Arm Height	26	Weight	140
Depth	26¾	Seat Depth	19	Back Height	33¾	Cubic Ft.	51.8
Height	33¾	Seat Width	21½	Back Width	21½		

- Contrasting fabric option – specify X (i.e., N78LCUX); see below. For list pricing, use your electronic specification tool or contact customer service
- Soft glide option available for a \$26 list upcharge

To Order Contrasting Fabric, Specify:

1. Model Number plus “X”
2. Back Fabric Grade Number/Cover Number
3. Extreme Back Fabric Grade Number/Cover Number
4. Seat Fabric Grade Number/Cover Number
5. Arm Fabric Grade Number/Cover Number
6. Arm Cap (when applicable)
7. Wood Back Finish Color (when applicable)
8. Leg Color

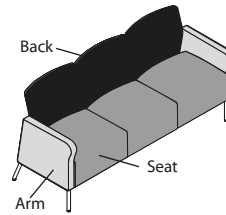

Contrasting Upholstery

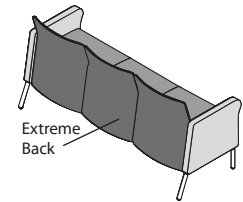

Contrasting Upholstery Back View

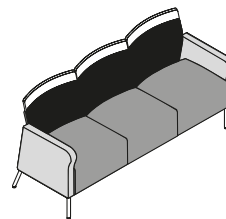

Contrasting Upholstery Wood Back

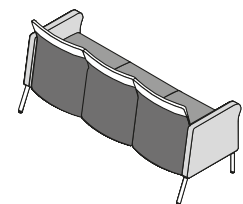

Contrasting Upholstery Wood Back Back View

Three Seat Lounge with Tablet

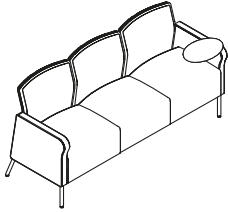

Upholstered

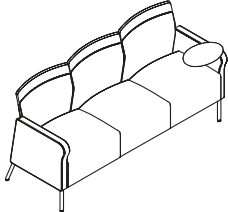

Wood Back

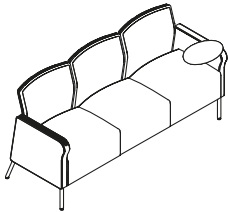

Tablet and Arm Cap

Model No.

Grade / List Price

		1	2/COM	3/COL	4	6	7	L7	L8
N78LCUR	Upholstered Back Tablet Right Arm	\$ 3461	3608	3679	3781	4101	4363	5624	6027
N78LCUL	Upholstered Back Tablet Left Arm	3461	3608	3679	3781	4101	4363	5624	6027
N78LCUB	Upholstered Back Tablet Both Arms	3714	3861	3932	4034	4354	4616	5877	6280
N78LCWR	Wood Back Tablet Right Arm	3928	4068	4135	4233	4538	4788	5990	6374
N78LCWL	Wood Back Tablet Left Arm	3928	4068	4135	4233	4538	4788	5990	6374
N78LCWB	Wood Back Tablet Both Arms	4181	4321	4388	4486	4791	5041	6243	6627

Dimensions

Width	71	Seat Height	18½	Arm Height	26	Weight	154
Depth	26%	Seat Depth	19	Back Height	33%	Cubic Ft.	63.9
Height	33%	Seat Width	21½	Back Width	21½		

- Contrasting fabric option – specify X (i.e., N78LCURX); see below. For list pricing, use your electronic specification tool or contact customer service
- Tablet available in black thermofoil or veneer
- Veneer tablet arm available in all wood finishes and Cinder and Designer White paint
- Arm cap is not an option on arm where tablet is specified
- Soft glide option available for a \$26 list upcharge

To Order Contrasting Fabric, Specify:

1. Model Number plus "X"
2. Back Fabric Grade Number/Cover Number
3. Extreme Back Fabric Grade Number/Cover Number
4. Seat Fabric Grade Number/Cover Number
5. Arm Fabric Grade Number/Cover Number
6. Tablet and Finish (when applicable)
7. Arm Cap (when applicable)
8. Wood Back Finish Color (when applicable)
9. Leg Color

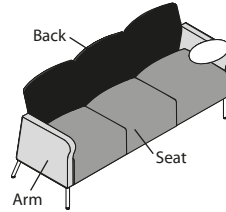

Contrasting Upholstery

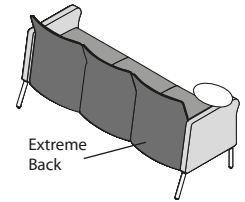

Contrasting Upholstery Back View

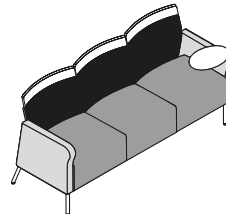

Contrasting Upholstery Wood Back

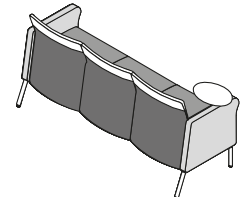

Contrasting Upholstery Wood Back Back View

Confide

To Order, Specify:

1. Model Number
2. Fabric Grade Number
3. Fabric Cover Number
4. Tablet and Finish (when applicable)
5. Arm Cap (when applicable)
6. Wood Back Finish Color (when applicable)
7. Leg Color

• See page 85 for Confide options

Two Seat Tandem Lounge



Upholstered

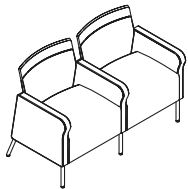

Wood Back



Arm Caps

Model No.

Grade / List Price

		1	2/COM	3/COL	4	6	7	L7	L8
N78LAAU	Upholstered Back	\$ 2926	3050	3110	3196	3466	3687	4751	5091
N78LAAW	Wood Back	3208	3325	3381	3463	3718	3927	4932	5253

Dimensions

Width	51½	Seat Height	18½	Arm Height	26	Weight	115
Depth	26¾	Seat Depth	19	Back Height	33¾	Cubic Ft.	37.5
Height	33¾	Seat Width	21½	Back Width	21½		

- Contrasting fabric option – specify X (i.e., N78LAAUX); see below. For list pricing, use your electronic specification tool or contact customer service
- Soft glide option available for a \$26 list upcharge

To Order Contrasting Fabric, Specify:

1. Model Number plus “X”
2. Back Fabric Grade Number/Cover Number
3. Extreme Back Fabric Grade Number/Cover Number
4. Seat Fabric Grade Number/Cover Number
5. Arm Fabric Grade Number/Cover Number
6. Arm Cap (when applicable)
7. Wood Back Finish Color (when applicable)
8. Leg Color

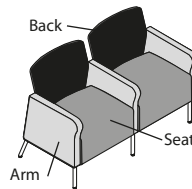

Contrasting Upholstery

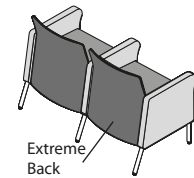

Contrasting Upholstery Back View

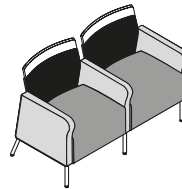

Contrasting Upholstery Wood Back

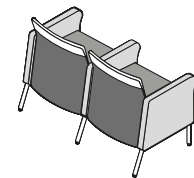

Contrasting Upholstery Wood Back Back View

Two Seat Tandem Lounge with Tablet

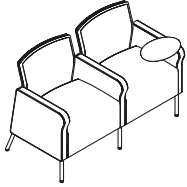

Upholstered

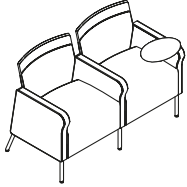

Wood Back

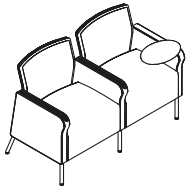

Tablet and Arm Caps

Model No.

Grade / List Price

		1	2/COM	3/COL	4	6	7	L7	L8
N78LAAUR	Upholstered Back Tablet Right Arm	\$ 3180	3304	3364	3450	3720	3941	5005	5345
N78LAAUL	Upholstered Back Tablet Left Arm	3180	3304	3364	3450	3720	3941	5005	5345
N78LAAUB	Upholstered Back Tablet Both Arms	3433	3557	3617	3703	3973	4194	5258	5598
N78LAAWR	Wood Back Tablet Right Arm	3461	3578	3634	3716	3971	4180	5185	5506
N78LAAWL	Wood Back Tablet Left Arm	3461	3578	3634	3716	3971	4180	5185	5506
N78LAAWB	Wood Back Tablet Both Arms	3714	3831	3887	3969	4224	4433	5438	5759

Dimensions

Width	51½	Seat Height	18½	Arm Height	26	Weight	129
Depth	26¾	Seat Depth	19	Back Height	33¾	Cubic Ft.	37.5
Height	33¾	Seat Width	21½	Back Width	21½		

- Contrasting fabric option – specify X (i.e., N78LAAURX); see below. For list pricing, use your electronic specification tool or contact customer service
- Tablet available in black thermofoil or veneer
- Veneer tablet arm available in all wood finishes and Cinder and Designer White paint
- Arm cap is not an option on arm where tablet is specified
- Soft glide option available for a \$26 list upcharge

To Order Contrasting Fabric, Specify:

1. Model Number plus "X"
2. Back Fabric Grade Number/Cover Number
3. Extreme Back Fabric Grade Number/Cover Number
4. Seat Fabric Grade Number/Cover Number
5. Arm Fabric Grade Number/Cover Number
6. Tablet and Finish (when applicable)
7. Arm Cap (when applicable)
8. Wood Back Finish Color (when applicable)
9. Leg Color

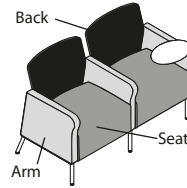

Contrasting Upholstery

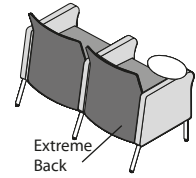

Contrasting Upholstery Back View

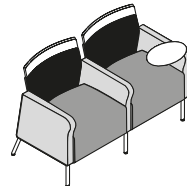

Contrasting Upholstery Wood Back

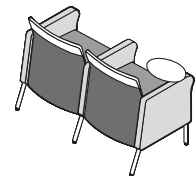

Contrasting Upholstery Wood Back Back View

Confide

To Order, Specify:

1. Model Number
2. Fabric Grade Number
3. Fabric Cover Number
4. Tablet and Finish (when applicable)
5. Arm Cap (when applicable)
6. Wood Back Finish Color (when applicable)
7. Leg Color

• See page 85 for Confide options

Three Seat Tandem Lounge

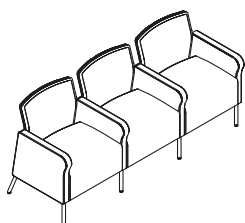

Upholstered

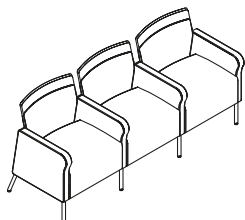

Wood Back

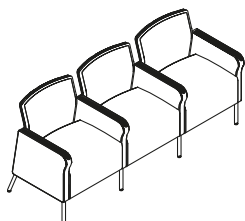

Arm Caps

Model No.

Grade / List Price

		1	2/COM	3/COL	4	6	7	L7	L8
N78LAAAU	Upholstered Back	\$ 3939	4114	4197	4319	4699	5011	6508	6987
N78LAAAW	Wood Back	4379	4554	4637	4759	5139	5451	6948	7427

Dimensions

Width	75%	Seat Height	18½	Arm Height	26	Weight	150
Depth	26%	Seat Depth	19	Back Height	33%	Cubic Ft.	51.8
Height	33%	Seat Width	21½	Back Width	21½		

- Contrasting fabric option – specify X (i.e., N78LAAUX); see below. For list pricing, use your electronic specification tool or contact customer service
- Soft glide option available for a \$26 list upcharge

To Order Contrasting Fabric, Specify:

1. Model Number plus "X"
2. Back Fabric Grade Number/Cover Number
3. Extreme Back Fabric Grade Number/Cover Number
4. Seat Fabric Grade Number/Cover Number
5. Arm Fabric Grade Number/Cover Number
6. Arm Cap (when applicable)
7. Wood Back Finish Color (when applicable)
8. Leg Color

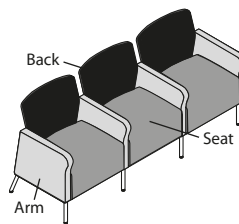

Contrasting Upholstery

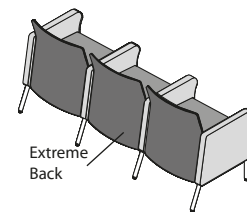

Contrasting Upholstery Back View

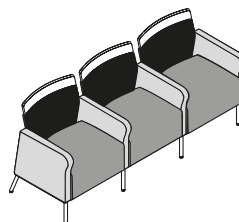

Contrasting Upholstery Wood Back

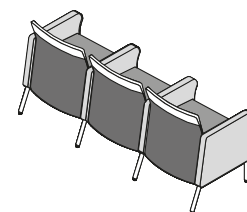

Contrasting Upholstery Wood Back Back View

Three Seat Tandem Lounge with Tablet

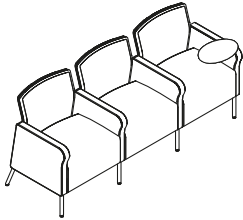

Upholstered

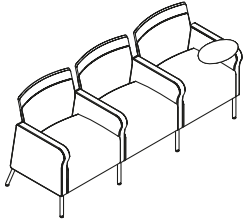

Wood Back

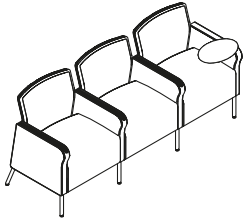

Tablet and Arm Caps

Model No.

Grade / List Price

		1	2/COM	3/COL	4	6	7	L7	L8
N78LAAAUR	Upholstered Back Tablet Right Arm	\$ 4193	4368	4451	4573	4953	5265	6762	7241
N78LAAAUL	Upholstered Back Tablet Left Arm	4193	4368	4451	4573	4953	5265	6762	7241
N78LAAAUB	Upholstered Back Tablet Both Arms	4447	4622	4705	4827	5207	5519	7016	7495
N78LAAAWR	Wood Back Tablet Right Arm	4631	4806	4889	5011	5391	5703	7200	7679
N78LAAAWL	Wood Back Tablet Left Arm	4631	4806	4889	5011	5391	5703	7200	7679
N78LAAAWB	Wood Back Tablet Both Arms	4884	5059	5142	5264	5644	5956	7453	7932

Dimensions

Width	75%	Seat Height	18½	Arm Height	26	Weight	164
Depth	26%	Seat Depth	19	Back Height	33%	Cubic Ft.	63.9
Height	33%	Seat Width	21½	Back Width	21½		

- Contrasting fabric option – specify X (i.e., N78LAAAURX); see below. For list pricing, use your electronic specification tool or contact customer service
- Tablet available in black thermofoil or veneer
- Veneer tablet arm available in all wood finishes and Cinder and Designer White paint
- Arm cap is not an option on arm where tablet is specified
- Soft glide option available for a \$26 list upcharge

To Order Contrasting Fabric, Specify:

1. Model Number plus "X"
2. Back Fabric Grade Number/Cover Number
3. Extreme Back Fabric Grade Number/Cover Number
4. Seat Fabric Grade Number/Cover Number
5. Arm Fabric Grade Number/Cover Number
6. Tablet and Finish (when applicable)
7. Arm Cap (when applicable)
8. Wood Back Finish Color (when applicable)
9. Leg Color

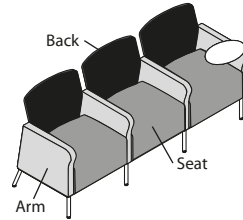

Contrasting Upholstery

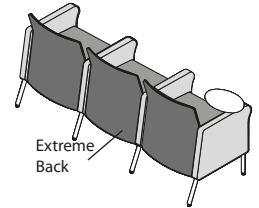

Contrasting Upholstery Back View

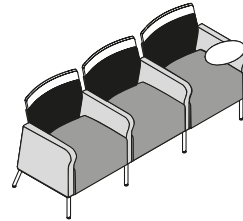

Contrasting Upholstery Wood Back

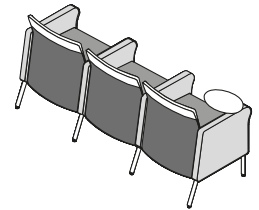

Contrasting Upholstery Wood Back Back View

Confide

To Order, Specify:

1. Model Number
2. Fabric Grade Number
3. Fabric Cover Number
4. Arm Cap (when applicable)
5. Wood Back Finish Color (when applicable)
6. Leg Color

• See page 85 for Confide options

Bariatric Lounge



Upholstered

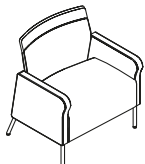

Wood Back



Arm Caps

Model No.	Grade / List Price								
		1	2/COM	3/COL	4	6	7	L7	L8
N78LEU	Upholstered Back	\$ 2195	2289	2334	2400	2605	2773	3581	3839
N78LEW	Wood Back	2393	2480	2522	2583	2773	2929	3677	3917

Dimensions

Width	37	Seat Height	18½	Arm Height	26	Weight	75
Depth	26¾	Seat Depth	19	Back Height	33¾	Cubic Ft.	31.0
Height	35¾	Seat Width	31½	Back Width	31½		

- Tested to and meets 500 lb. weight load
- Contrasting fabric option – specify X (i.e., N78LEUX); see below. For list pricing, use your electronic specification tool or contact customer service
- Soft glide option available for a \$26 list upcharge

To Order Contrasting Fabric, Specify:

1. Model Number plus “X”
2. Back Fabric Grade Number/Cover Number
3. Extreme Back Fabric Grade Number/Cover Number
4. Seat Fabric Grade Number/Cover Number
5. Arm Fabric Grade Number/Cover Number
6. Arm Cap (when applicable)
7. Wood Back Finish Color (when applicable)
8. Leg Color

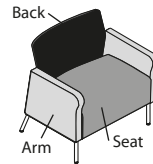

Contrasting Upholstery

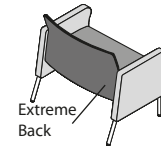

Contrasting Upholstery Back View

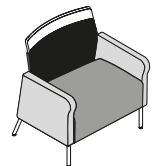

Contrasting Upholstery Wood Back

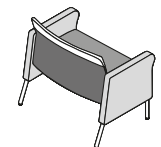

Contrasting Upholstery Wood Back View

Personal Pull-up Table



10N1622RTPUW	Wood	\$ 955
10N1622RTPUL	Laminate	955

Dimensions

Width	22	Weight	32
Depth	13¾	Cubic Ft.	9.25
Height	28½		

- 50 lb. weight limit
- Specify metal finish (462) Cinder, (501) Platinum Metallic, or (503) Satin Nickel Metallic
- Specify laminate or wood finish; **Laminates** (NM) Natural, (HN2) Honey 2, (CL) Caramel, (TF) Truffle, (AC2) Autumn 2, (MC) Amber, (CW) Cordovan, (DW) Judicial, (MH) Mocha, (405) Designer White, (462) Cinder, (791) Palisander, (792) Sable, or (793) Acorn; **Wood Finishes** (NM) Natural, (HN) Honey, (CL) Caramel, (TF) Truffle, (AC) Autumn, (MC) Amber, (CW) Cordovan, (DW) Judicial, (MH) Mocha, (405) Designer White, (462) Cinder, (792) Sable, or (793) Acorn

End Table



End Table

Model No.

Grade / List Price

N78SNW	Wood	\$ 1014
N78SNL	Laminate	1014

Dimensions

Width	22	Weight	15
Depth	21¼	Cubic Ft.	6.8
Height	16⅞		

- Soft glide option available for a \$26 list upcharge

Magazine Table

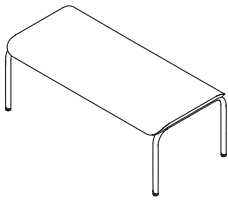

Magazine Table

N78SMW	Wood	\$ 1576
N78SML	Laminate	1576

Dimensions

Width	44	Weight	24
Depth	21¼	Cubic Ft.	14.2
Height	16⅞		

- Soft glide option available for a \$26 list upcharge

Confide

CONFIDE PRODUCT SPECIFICATIONS—GUEST, TANDEM, BARIATRIC, GANGING STARTERS AND TABLES, BENCHES

78 Series

SIDE SEATING

SEAT CONSTRUCTION

- 1" of high grade polyurethane foam covers a plywood seat panel
- Easy clean wipe out feature

FULLY UPHOLSTERED BACK CONSTRUCTION

- 2" of high grade polyurethane foam covers a plywood back panel

EXPOSED WOOD BACK CONSTRUCTION

- 2" of high grade polyurethane foam covers a plywood back panel

ARMS

- Arms are die-cast aluminum available in Cinder, Platinum Metallic and Satin Nickel Metallic

FRAME CONSTRUCTION

- Frame is made from $\frac{7}{8}$ " x $1\frac{1}{4}$ " 16-gauge elliptical tubular steel
- Cross members are joined with inert gas (MIG) welds
- Wall saving design feature

CONTRASTING FABRIC

- Contrasting fabric available on all models except benches

ARM CAPS

- Black protective polyurethane is standard on all models
- Decorative solid hard maple cap option is available

GLIDES

- Front leg features a 1" adjustable leveling glide
- Back leg features a 1" adjustable swivel glide
- Soft glides are available for an additional upcharge

FINISHES

- Cinder, Platinum Metallic and Satin Nickel Metallic frames are finished with an electrostatic baked-on powder coat
- Wood components feature a catalyzed top coat that resists denting, peeling and reactions to chemicals
- Can be cleaned with a damp cloth
- Features our silver ion antimicrobial finish which inhibits the growth of bacteria and microbes

WOOD SPECIES

- Hard maple



TABLES

FRAME CONSTRUCTION

- Table frame is made from $\frac{7}{8}$ " x $1\frac{1}{4}$ " 16-gauge elliptical tubular steel
- Cross members are made from $\frac{7}{8}$ " 16-gauge round tubular steel
- Cross members are joined to the U-bent side members with metal inert gas (MIG) welds

TOPS

- Veneer models feature a $\frac{3}{4}$ " molded laminated HDF core slipmatched maple veneer
- Laminate models feature a $\frac{3}{4}$ " molded laminated HDF core with laminate (HPL) top

All Confide Side Seating models may be ordered to meet TB133 fire code.

To order seating to meet the TB133 fire code specify an "F" at the end of the model number (Ex: N78GFAUF).

Please consult customer service for applicable Arc-Com, COM, Maharam, Momentum, Stinson or Ultrafabrics fabric.



For comprehensive sustainability information that includes LEED® point contribution, visit NationalOfficeFurniture.ecoScorecard.com.

FABRICS

Grade 1	American Graffiti
	Cali
	Plush
	Ridge
	Speedway Stardust
Grade 2	Cathedral
	COM
	Orbit
	Pixie
	Sedona
	Shenanigans
	Spectrum
	Strand
	Tranquility Twilight

Grade 3	Boardwalk
	COL
	Jacks Pop Rocks

Grade 4	Big City
	Bumble
	Connect Four
	Echo Silvertex

Grade 6	Essence/Ultraleather
	Flock
	Scribe

Grade 7	Brisa
	Brisa Distressed
	Promessa
	Silica

Grade L7 Davenport

Grade L8 Showcase

FINISHES

IM Brighton	CW Cordovan
NM Natural	DW Judicial
HN Honey	MH Mocha
CL Caramel	405 Designer White
TF Truffle	462 Cinder
AC Autumn	792 Sable
MC Amber	793 Acorn

LAMINATES

IM Brighton	DW Judicial
NM Natural	MH Mocha
HN2 Honey 2	405 Designer White
CL Caramel	462 Cinder
TF Truffle	*791 Palisander
AC2 Autumn 2	792 Sable
MC Amber	793 Acorn
CW Cordovan	

*791 Palisander laminate coordinates with (NM) Natural, (HN) Honey and (MH) Mocha finishes

ARM CAP

(\$55 upcharge per wood arm cap)

CAP_U	Polyurethane
CAP_IM	Brighton
CAP_NM	Natural
CAP_HN	Honey
CAP_CL	Caramel
CAP_TF	Truffle
CAP_AC	Autumn
CAP_MC	Amber
CAP_CW	Cordovan
CAP_DW	Judicial
CAP_MH	Mocha
CAP_405	Designer White
CAP_462	Cinder
CAP_792	Sable
CAP_793	Acorn
X	No Cap

POWDER COAT PAINTS

462	Cinder
501	Platinum Metallic
503	Satin Nickel Metallic

GLIDES

STD	Standard
C10	Soft (add \$26 list)

CONFIDE GANGING MATRIX

		N78GFAW / N78GFAU GUEST, ARM, WOOD or UPH BACK	N78SFAW / N78SFAU STARTER, ARM, WOOD or UPH BACK	N78GFMW / N78GFMU GUEST, ARMLESS, WOOD or UPH BACK	N78SFMW / N78SFMU STARTER, ARMLESS, WOOD or UPH BACK	N78T2AW / N78T2AU TWO SEAT TANDEM, ARMS AND LEGS, WOOD or UPH BACK	N78B2AW / N78B2AU TWO SEAT TANDEM, ARMS, NO CENTER LEG WOOD or UPH BACK	N78B2EW / N78B2EU TWO SEAT TANDEM, NO CENTER ARMS OR LEG, WOOD or UPH BACK	N78T3AW / N78T3AU THREE SEAT TANDEM, ARMS AND LEGS, WOOD or UPH BACK	N78B3AW / N78B3AU THREE SEAT TANDEM, ARMS, NO CENTER LEG WOOD or UPH BACK	N78B3EW / N78B3EU THREE SEAT TANDEM, NO CENTER ARMS OR LEG, WOOD or UPH BACK	N78AFLAW / N78AFLAU GUEST ADD-ON, LEFT ARM/LEG, WOOD or UPH BACK	N78AFLMW / N78AFLMU GUEST ADD-ON, ARMLESS, LEFT LEG, WOOD or UPH BACK	N78AFRAW / N78AFRAU GUEST ADD-ON, RIGHT ARM/LEG, WOOD or UPH BACK	N78AFRMW / N78AFRUM GUEST ADD-ON, ARMLESS, RIGHT LEG, WOOD or UPH BACK	N78GEAW / N78GEAU BARIATRIC, WOOD or UPH BACK	N78TCW / N78TCL TABLE, GANGING CENTER, WOOD or LAM	N78TEW / N78TEL TABLE, GANGING END, WOOD or LAM	N78TNW / N78TNL TABLE, GANGING CORNER, WOOD or LAM	N78D1M BENCH, ONE SEAT, ARMLESS	N78D2M / N78D2A BENCH, TWO SEAT, ARM, ARMLESS	N78D3M / N78D3A BENCH, THREE SEAT, ARM, ARMLESS	N78PAU PATIENT, ARMS, UPH BACK		
N78GFAW N78GFAU	GUEST, ARM, WOOD or UPH BACK																								
N78SFAW N78SFAU	STARTER, ARM, WOOD or UPH BACK																								
N78GFMW N78GFMU	GUEST, ARMLESS, WOOD or UPH BACK																								
N78SFMW N78SFMU	STARTER, ARMLESS, WOOD or UPH BACK																								
N78T2AW N78T2AU	TWO SEAT TANDEM, ARMS AND LEGS, WOOD or UPH BACK																								
N78B2AW N78B2AU	TWO SEAT TANDEM, ARMS, NO CENTER LEG WOOD or UPH BACK																								
N78B2EW N78B2EU	TWO SEAT TANDEM, NO CENTER ARMS OR LEG, WOOD or UPH BACK																								
N78T3AW N78T3AU	THREE SEAT TANDEM, ARMS AND LEGS, WOOD or UPH BACK																								
N78B3AW N78B3AU	THREE SEAT TANDEM, ARMS, NO CENTER LEG WOOD or UPH BACK																								
N78B3EW N78B3EU	THREE SEAT TANDEM, NO CENTER ARMS OR LEG, WOOD or UPH BACK																								
N78AFLAW N78AFLAU	GUEST ADD-ON, LEFT ARM/LEG, WOOD or UPH BACK		X		X	X																			
N78AFLMW N78AFLMU	GUEST ADD-ON, ARMLESS, LEFT LEG, WOOD or UPH BACK		X		X	X																			
N78AFRAW N78AFRAU	GUEST ADD-ON, RIGHT ARM/LEG, WOOD or UPH BACK		X		X	X																			
N78AFRMW N78AFRUM	GUEST ADD-ON, ARMLESS, RIGHT LEG, WOOD or UPH BACK		X		X	X																			
N78GEAW N78GEAU	BARIATRIC, WOOD or UPH BACK																								
N78TCW N78TCL	TABLE, GANGING CENTER, WOOD or LAM		X*		X*	X*	X*	X*																	
N78TEW N78TEL	TABLE, GANGING END, WOOD or LAM		X		X	X	X	X																	
N78TNW N78TNL	TABLE, GANGING CORNER, WOOD or LAM		X*		X*	X*	X*	X*																	
N78D1M	BENCH, ONE SEAT, ARMLESS																								
N78D2M N78D2A	BENCH, TWO SEAT, ARM, ARMLESS																								
N78D3M N78D3A	BENCH, THREE SEAT, ARM, ARMLESS																								
N78PAU	PATIENT, ARMS, UPH BACK																								

- *Corner and center tables must be ganged between starter chairs, tandem seating, bariatric chairs or benches
- Tandem with no center legs, bariatric, and benches can only be ganged to tables
 - Guest side and patient chairs cannot be ganged to other units
 - No limit the number of add-on connections
 - End and corner tables are non-handed
 - Add-on models are listed as seated

	N78T3AW / N78T3AU THREE SEAT TANDEM, ARMS AND LEGS, WOOD or UPH BACK																		
	N78B3AW / N78B3AU THREE SEAT TANDEM, ARMS, NO CENTER LEG WOOD or UPH BACK																		
	N78B3EW / N78B3EU THREE SEAT TANDEM, NO CENTER ARMS OR LEG, WOOD or UPH BACK																		
	N78AFLAW / N78AFLAU GUEST ADD-ON, LEFT ARM/LEG, WOOD or UPH BACK			X															
	N78AFLMW / N78AFLMU GUEST ADD-ON, ARMLESS/ LEFT LEG, WOOD or UPH BACK			X															
	N78AFRAW / N78AFRAU GUEST ADD-ON, RIGHT ARM/LEG, WOOD or UPH BACK			X															
	N78AFRMW / N78AFRMU GUEST ADD-ON, ARMLESS/ RIGHT LEG, WOOD or UPH BACK			X															
	N78GEAW / N78GEAU BARIATRIC, WOOD or UPH BACK																		
	N78TCW / N78TCL TABLE, GANGING CENTER, WOOD or LAM									X*									
	N78TEW / N78TEL TABLE, GANGING END, WOOD or LAM									X									
	N78TNW / N78TNL TABLE, GANGING CORNER, WOOD or LAM									X*									
	N78D1M BENCH, ONE SEAT, ARMLESS																		
	N78D2M / N78D2A BENCH, TWO SEAT, ARM, ARMLESS																		
	N78D3M / N78D3A BENCH, THREE SEAT, ARM, ARMLESS																		
	N78PAU PATIENT, ARMS, UPH BACK																		

Confide

To You In **10 DAYS** ...or Less

Shaded model numbers are available on our "To You in 10 Days or Less" Quick Delivery program and will be delivered within 10 days.

To Order, Specify:

1. Model Number
2. Fabric Grade Number
3. Fabric Cover Number
4. Arm Cap (when applicable)
5. Arm Cap Finish (when applicable)
6. Wood Back Finish Color (when applicable)
7. Frame Color
8. Glides

• See page 99 for Confide options

Guest with Arms



Upholstered



Wood Back

Model No. Grade / List Price

Quick Delivery Models: QN78GFAU, QN78GFAW

		1	2/COM	3/COL	4	6	7	L7	L8
N78GFAU	Upholstered Back	\$ 1209	1244	1260	1284	1359	1421	1716	1811
N78GFAW	Wood Back	1350	1382	1398	1420	1490	1547	1823	1911

Dimensions

Width	24	Seat Height	19	Arm Height	26¾	Weight	48
Depth	23	Seat Depth	20	Back Height	33¾	Cubic Ft.	16.3
Height	33½	Seat Width	22½	Back Width	20¾		

- Contrasting fabric option – specify X (i.e., N78GFAUX). For list pricing, use your electronic specification tool or contact customer service
- Polyurethane arm caps are standard. Wood arm cap option available for a \$55 list upcharge per cap
- Soft glide option available for a \$26 list upcharge

Guest Armless



Upholstered



Wood Back

Quick Delivery Models: QN78GFMU, QN78GFMW

		1	2/COM	3/COL	4	6	7	L7	L8
N78GFMU	Upholstered Back	\$ 1126	1161	1177	1201	1276	1338	1633	1728
N78GFMW	Wood Back	1267	1299	1315	1337	1407	1464	1740	1828

Dimensions

Width	24	Seat Height	19	Back Height	33¾	Weight	46
Depth	23	Seat Depth	20	Back Width	20¾	Cubic Ft.	16.3
Height	33½	Seat Width	22½				

- Contrasting fabric option – specify X (i.e., N78GFMUX). For list pricing, use your electronic specification tool or contact customer service
- Soft glide option available for a \$26 list upcharge

To Order Contrasting Fabric, Specify:

1. Model Number plus "X"
2. Back Fabric Grade Number/Cover Number
3. Extreme Back Fabric Grade Number/Cover Number
4. Seat Fabric Grade Number/Cover Number
5. Arm Cap (when applicable)
6. Arm Cap Finish (when applicable)
7. Wood Back Finish Color (when applicable)
8. Frame Color
9. Glides

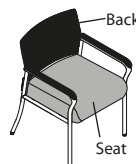

Contrasting Upholstery



Contrasting Upholstery Back View



Contrasting Upholstery Wood Back

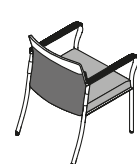

Contrasting Upholstery Wood Back Back View

Starter with Arms



Upholstered



Wood Back

Model No.

Grade / List Price

		1	2/COM	3/COL	4	6	7	L7	L8
N78SFAU	Upholstered Back	\$ 1321	1356	1372	1396	1471	1533	1828	1923
N78SFAW	Wood Back	1463	1495	1511	1533	1603	1660	1936	2024

Dimensions

Width	24	Seat Height	19	Arm Height	26%	Weight	50
Depth	23	Seat Depth	20	Back Height	33¼	Cubic Ft.	16.3
Height	33½	Seat Width	22½	Back Width	20%		

- Contrasting fabric option – specify X (i.e., N78SFAUX). For list pricing, use your electronic specification tool or contact customer service
- Polyurethane arm caps are standard. Wood arm cap option available for a \$55 list upcharge per cap
- Soft glide option available for a \$26 list upcharge

Starter Armless



Upholstered



Wood Back

		1	2/COM	3/COL	4	6	7	L7	L8
N78SFMU	Upholstered Back	\$ 1238	1273	1289	1313	1388	1450	1745	1840
N78SFMW	Wood Back	1379	1411	1427	1449	1519	1576	1852	1940

Dimensions

Width	24	Seat Height	19	Back Height	33¼	Weight	48
Depth	23	Seat Depth	20	Back Width	20%	Cubic Ft.	16.3
Height	33½	Seat Width	22½				

- Contrasting fabric option – specify X (i.e., N78SFMUX). For list pricing, use your electronic specification tool or contact customer service
- Soft glide option available for a \$26 list upcharge

To Order Contrasting Fabric, Specify:

1. Model Number plus "X"
2. Back Fabric Grade Number/Cover Number
3. Extreme Back Fabric Grade Number/Cover Number
4. Seat Fabric Grade Number/Cover Number
5. Arm Cap (when applicable)
6. Arm Cap Finish (when applicable)
7. Wood Back Finish Color (when applicable)
8. Frame Color
9. Glides

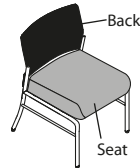

Contrasting Upholstery

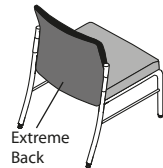

Contrasting Upholstery Back View



Contrasting Upholstery Wood Back

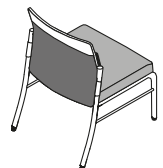

Contrasting Upholstery Wood Back Back View

Confide

To Order, Specify:

1. Model Number
2. Fabric Grade Number
3. Fabric Cover Number
4. Arm Cap
5. Arm Cap Finish (when applicable)
6. Wood Back Finish Color (when applicable)
7. Frame Color
8. Glides

• See page 99 for Confide options

Add-On with Arm



Upholstered Left Arm



Upholstered Right Arm



Wood Left Arm

Model No.	Grade / List Price	Grade / List Price							
		1	2/COM	3/COL	4	6	7	L7	L8
N78AFLAU	Upholstered Back Left Arm	\$ 1181	1216	1232	1256	1331	1393	1688	1783
N78AFRAU	Upholstered Back Right Arm	1181	1216	1232	1256	1331	1393	1688	1783
N78AFLAW	Wood Back Left Arm	1321	1353	1369	1391	1461	1518	1794	1882
N78AFRAW	Wood Back Right Arm	1321	1353	1369	1391	1461	1518	1794	1882

Dimensions

Width	24	Seat Height	19	Arm Height	26¾	Weight	42
Depth	23	Seat Depth	20	Back Height	33¼	Cubic Ft.	16.3
Height	33½	Seat Width	22½	Back Width	20¾		

- Contrasting fabric option – specify X (i.e., N78AFLAUX). For list pricing, use your electronic specification tool or contact customer service
- Polyurethane arm caps are standard. Wood arm cap option available for a \$55 list upcharge per cap
- Soft glide option available for a \$26 list upcharge

To Order Contrasting Fabric, Specify:

1. Model Number plus “X”
2. Back Fabric Grade Number/Cover Number
3. Extreme Back Fabric Grade Number/Cover Number
4. Seat Fabric Grade Number/Cover Number
5. Arm Cap
6. Arm Cap Finish (when applicable)
7. Wood Back Finish Color (when applicable)
8. Frame Color
9. Glides

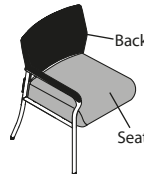

Contrasting Upholstery

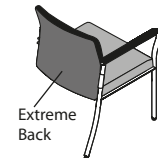

Contrasting Upholstery Back View



Contrasting Upholstery Wood Back

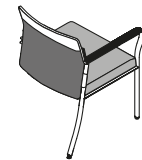

Contrasting Upholstery Wood Back Back View

Add-On Armless

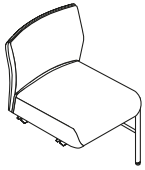

Upholstered Left Leg



Upholstered Right Leg

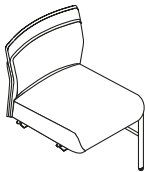

Wood Left Leg

Model No.

Grade / List Price

		1	2/COM	3/COL	4	6	7	L7	L8
N78AFLMU	Upholstered Back Armless Left Leg	\$ 1097	1132	1148	1172	1247	1309	1604	1699
N78AFRMU	Upholstered Back Armless Right Leg	1097	1132	1148	1172	1247	1309	1604	1699
N78AFLMW	Wood Back Armless Left Leg	1238	1270	1286	1308	1378	1435	1711	1799
N78AFRMW	Wood Back Armless Right Leg	1238	1270	1286	1308	1378	1435	1711	1799

Dimensions

Width	24	Seat Height	19	Back Height	33¼	Weight	40
Depth	23	Seat Depth	20	Back Width	20¾	Cubic Ft.	16.3
Height	33½	Seat Width	22½				

- Contrasting fabric option – specify X (i.e., N78AFLAUX). For list pricing, use your electronic specification tool or contact customer service
- Polyurethane arm caps are standard. Wood arm cap option available for a \$55 list upcharge per cap
- Soft glide option available for a \$26 list upcharge

To Order Contrasting Fabric, Specify:

1. Model Number plus "X"
2. Back Fabric Grade Number/Cover Number
3. Extreme Back Fabric Grade Number/Cover Number
4. Seat Fabric Grade Number/Cover Number
5. Wood Back Finish Color (when applicable)
6. Frame Color
7. Glides

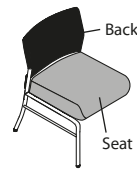

Contrasting Upholstery

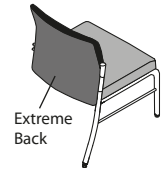

Contrasting Upholstery Back View



Contrasting Upholstery Wood Back

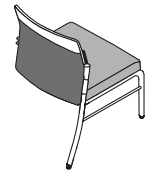

Contrasting Upholstery Wood Back Back View

Confide

To Order, Specify:

1. Model Number
2. Fabric Grade Number
3. Fabric Cover Number
4. Arm Cap
5. Arm Cap Finish (when applicable)
6. Wood Back Finish Color (when applicable)
7. Frame Color
8. Glides

• See page 99 for Confide options

Two Seat Tandem Arms and Legs



Upholstered



Wood Back

Model No.

Grade / List Price

		1	2/COM	3/COL	4	6	7	L7	L8
N78T2AU	Upholstered Back	\$ 2447	2511	2542	2587	2727	2842	3393	3570
N78T2AW	Wood Back	2730	2785	2812	2850	2970	3068	3541	3692

Dimensions

Width	46½	Seat Height	19	Arm Height	26¾	Weight	83
Depth	23	Seat Depth	20	Back Height	33¼	Cubic Ft.	29.4
Height	33½	Seat Width	22½	Back Width	20¾		

- Contrasting fabric option – specify X (i.e., N78T2AUX). For list pricing, use your electronic specification tool or contact customer service
- Polyurethane arm caps are standard. Wood arm cap option available for a \$55 list upcharge per cap
- Soft glide option available for a \$26 list upcharge

To Order Contrasting Fabric, Specify:

1. Model Number plus “X”
2. Back Fabric Grade Number/Cover Number
3. Extreme Back Fabric Grade Number/Cover Number
4. Seat Fabric Grade Number/Cover Number
5. Arm Cap
6. Arm Cap Finish (when applicable)
7. Wood Back Finish Color (when applicable)
8. Frame Color
9. Glides

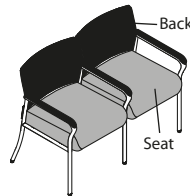

Contrasting Upholstery

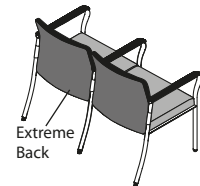

Contrasting Upholstery Back View



Contrasting Upholstery Wood Back

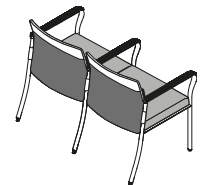

Contrasting Upholstery Wood Back Back View

Two Seat Tandem Arms and No Center Legs

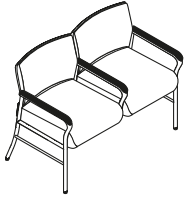

Upholstered

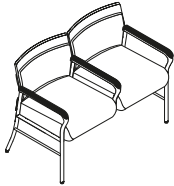

Wood Back

Model No.

Grade / List Price

		1	2/COM	3/COL	4	6	7	L7	L8
N78B2AU	Upholstered Back	\$ 2476	2540	2571	2616	2756	2871	3422	3599
N78B2AW	Wood Back	2758	2813	2840	2878	2998	3096	3569	3720

Dimensions

Width	46½	Seat Height	19	Arm Height	26¾	Weight	83
Depth	23	Seat Depth	20	Back Height	33¼	Cubic Ft.	29.4
Height	33½	Seat Width	22½	Back Width	20¾		

- Contrasting fabric option – specify X (i.e., N78B2AUX). For list pricing, use your electronic specification tool or contact customer service
- Polyurethane arm caps are standard. Wood arm cap option available for a \$55 list upcharge per cap
- Soft glide option available for a \$26 list upcharge

Two Seat Tandem No Center Arms and Legs

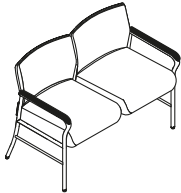

Upholstered

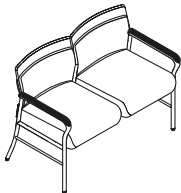

Wood Back

		1	2/COM	3/COL	4	6	7	L7	L8
N78B2EU	Upholstered Back	\$ 2419	2483	2514	2559	2699	2814	3365	3542
N78B2EW	Wood Back	2701	2756	2783	2821	2941	3039	3512	3663

Dimensions

Width	46½	Seat Height	19	Arm Height	26¾	Weight	80
Depth	23	Seat Depth	20	Back Height	33¼	Cubic Ft.	29.4
Height	33½	Seat Width	22½	Back Width	20¾		

- Contrasting fabric option – specify X (i.e., N78B2EUX). For list pricing, use your electronic specification tool or contact customer service
- Polyurethane arm caps are standard. Wood arm cap option available for a \$55 list upcharge per cap
- Soft glide option available for a \$26 list upcharge

To Order Contrasting Fabric, Specify:

1. Model Number plus "X"
2. Back Fabric Grade Number/Cover Number
3. Extreme Back Fabric Grade Number/Cover Number
4. Seat Fabric Grade Number/Cover Number
5. Arm Cap
6. Arm Cap Finish (when applicable)
7. Wood Back Finish Color (when applicable)
8. Frame Color
9. Glides

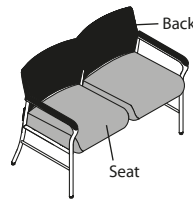

Contrasting Upholstery

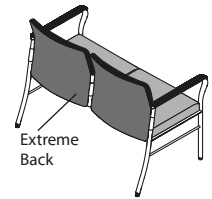

Contrasting Upholstery Back View

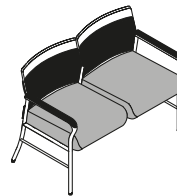

Contrasting Upholstery Wood Back

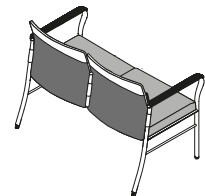

Contrasting Upholstery Wood Back Back View

Confide

To Order, Specify:

1. Model Number
2. Fabric Grade Number
3. Fabric Cover Number
4. Arm Cap
5. Arm Cap Finish (when applicable)
6. Wood Back Finish Color (when applicable)
7. Frame Color
8. Glides

• See page 99 for Confide options

Three Seat Tandem Arms and Legs



Upholstered

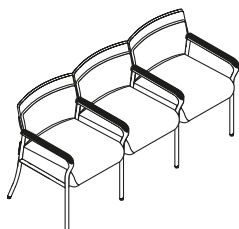

Wood Back

Model No.

Grade / List Price

		1	2/COM	3/COL	4	6	7	L7	L8
N78T3AU	Upholstered Back	\$ 3631	3725	3770	3836	4041	4209	5017	5275
N78T3AW	Wood Back	4052	4137	4178	4237	4422	4574	5303	5536

Dimensions

Width	69	Seat Height	19	Arm Height	26¾	Weight	117
Depth	23	Seat Depth	20	Back Height	33¼	Cubic Ft.	42.6
Height	33½	Seat Width	22½	Back Width	20¾		

- Contrasting fabric option – specify X (i.e., N78T3AUX). For list pricing, use your electronic specification tool or contact customer service
- Polyurethane arm caps are standard. Wood arm cap option available for a \$55 list upcharge per cap
- Soft glide option available for a \$26 list upcharge

To Order Contrasting Fabric, Specify:

1. Model Number plus "X"
2. Back Fabric Grade Number/Cover Number
3. Extreme Back Fabric Grade Number/Cover Number
4. Seat Fabric Grade Number/Cover Number
5. Arm Cap
6. Arm Cap Finish (when applicable)
7. Wood Back Finish Color (when applicable)
8. Frame Color
9. Glides

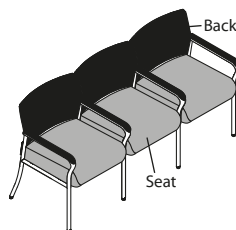

Contrasting Upholstery

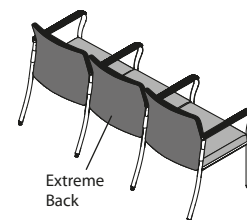

Contrasting Upholstery Back View

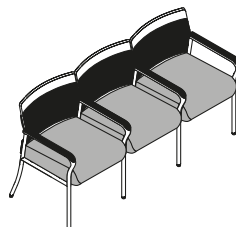

Contrasting Upholstery Wood Back

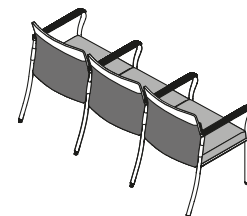

Contrasting Upholstery Wood Back Back View

Three Seat Tandem Arms and No Center Legs

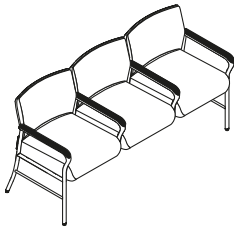

Upholstered

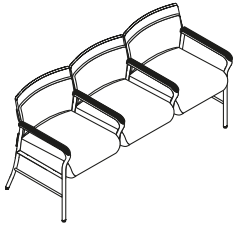

Wood Back

Model No.

Grade / List Price

		1	2/COM	3/COL	4	6	7	L7	L8
N78B3AU	Upholstered Back	\$ 3658	3752	3797	3863	4068	4236	5044	5302
N78B3AW	Wood Back	4080	4165	4206	4265	4450	4602	5331	5564

Dimensions

Width	69	Seat Height	19	Arm Height	26¾	Weight	117
Depth	23	Seat Depth	20	Back Height	33¼	Cubic Ft.	42.6
Height	33½	Seat Width	22½	Back Width	20¾		

- Contrasting fabric option – specify X (i.e., N78B3AUX). For list pricing, use your electronic specification tool or contact customer service
- Polyurethane arm caps are standard. Wood arm cap option available for a \$55 list upcharge per cap
- Soft glide option available for a \$26 list upcharge

Three Seat Tandem No Center Arms and Legs

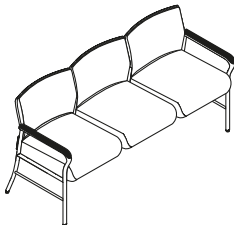

Upholstered

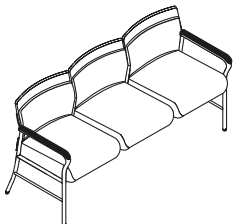

Wood Back

		1	2/COM	3/COL	4	6	7	L7	L8
N78B3EU	Upholstered Back	\$ 3602	3696	3741	3807	4012	4180	4988	5246
N78B3EW	Wood Back	4023	4108	4149	4208	4393	4545	5274	5507

Dimensions

Width	69	Seat Height	19	Arm Height	26¾	Weight	115
Depth	23	Seat Depth	20	Back Height	33¼	Cubic Ft.	42.6
Height	33½	Seat Width	22½	Back Width	20¾		

- Contrasting fabric option – specify X (i.e., N78B3EUX). For list pricing, use your electronic specification tool or contact customer service
- Polyurethane arm caps are standard. Wood arm cap option available for a \$55 list upcharge per cap
- Soft glide option available for a \$26 list upcharge

To Order Contrasting Fabric, Specify:

1. Model Number plus "X"
2. Back Fabric Grade Number/Cover Number
3. Extreme Back Fabric Grade Number/Cover Number
4. Seat Fabric Grade Number/Cover Number
5. Arm Cap
6. Arm Cap Finish (when applicable)
7. Wood Back Finish Color (when applicable)
8. Frame Color
9. Glides

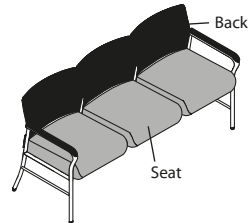

Contrasting Upholstery

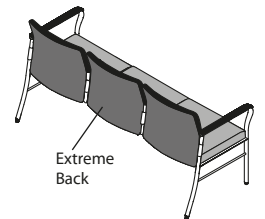

Contrasting Upholstery Back View

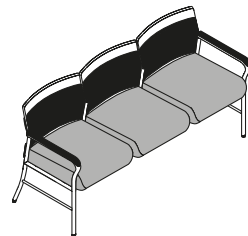

Contrasting Upholstery Wood Back

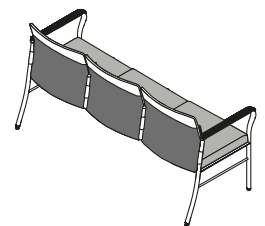

Contrasting Upholstery Wood Back Back View

To Order, Specify:

1. Model Number
2. Fabric Grade Number
3. Fabric Cover Number
4. Arm Cap
5. Arm Cap Finish (when applicable)
6. Wood Back Finish Color (when applicable)
7. Frame Color
8. Glides

• See page 99 for Confide options

Bariatric Guest



Upholstered



Wood Back

Model No.	Grade / List Price	Grade / List Price							
		1	2/COM	3/COL	4	6	7	L7	L8
N78GEAU	Upholstered Back	\$ 1885	1933	1956	1990	2095	2181	2595	2727
N78GEAW	Wood Back	2083	2127	2148	2178	2273	2351	2725	2845

Dimensions

Width	34	Seat Height	19	Arm Height	26¾	Weight	60
Depth	23	Seat Depth	20	Back Height	33¼	Cubic Ft.	24.6
Height	33½	Seat Width	32	Back Width	30¾		

- Contrasting fabric option – specify X (i.e., N78GEAUX). For list pricing, use your electronic specification tool or contact customer service
- Polyurethane arm caps are standard. Wood arm cap option available for a \$55 list upcharge per cap
- Tested to and meets 500 lb. weight load
- Soft glide option available for a \$26 list upcharge

Patient Guest



Model No.	Grade / List Price	Grade / List Price							
		1	2/COM	3/COL	4	6	7	L7	L8
N78PAU	Upholstered Back	\$ 1408	1449	1469	1498	1588	1662	2016	2130

Dimensions

Width	24	Seat Height	19	Arm Height	26¾	Weight	51
Depth	23	Seat Depth	20	Back Height	33¼	Cubic Ft.	20.2
Height	44	Seat Width	22½	Back Width	20¾		

- Contrasting fabric option – specify X (i.e., N78PAUX). For list pricing, use your electronic specification tool or contact customer service
- Polyurethane arm caps are standard. Wood arm cap option available for a \$55 list upcharge per cap
- Soft glide option available for a \$26 list upcharge

To Order Contrasting Fabric, Specify:

1. Model Number plus “X”
2. Back Fabric Grade Number/Cover Number
3. Extreme Back Fabric Grade Number/Cover Number
4. Seat Fabric Grade Number/Cover Number
5. Arm Cap
6. Arm Cap Finish (when applicable)
7. Wood Back Finish Color (when applicable)
8. Frame Color
9. Glides

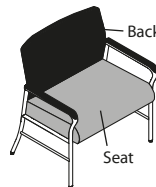

Upholstered Contrasting

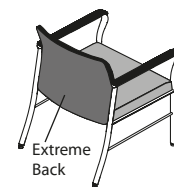

Contrasting Upholstery Back View

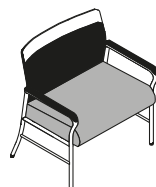

Contrasting Upholstery Wood Back

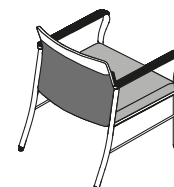

Contrasting Upholstery Wood Back Back View

One Seat Bench

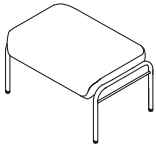

Model No.

Grade / List Price

		1	2/COM	3/COL	4	6	7	L7	L8
N78D1M	Armless	\$ 929	954	966	984	1039	1084	1301	1370

Dimensions

Width	24	Seat Height	18¾	Weight	55
Depth	22½	Seat Depth	22½	Cubic Ft.	8.2
Height	18¾	Seat Width	24		

- Soft glide option available for a \$26 list upcharge

Two Seat Bench

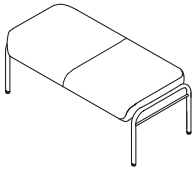

Armless

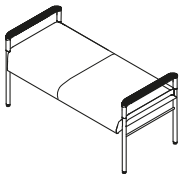

Arms

		1	2/COM	3/COL	4	6	7	L7	L8
N78D2M	Armless	\$ 1181	1222	1242	1271	1361	1435	1789	1903
N78D2A	Arms	1576	1617	1637	1666	1756	1830	2184	2298

Dimensions

Width	46¼	Seat Height	18¾	Arm Height	24¾	Armless Weight	65
Depth	22½	Seat Depth	22½			Arm Weight	70
Armless Height	18¾	Seat Width	46			Armless Cubic Ft.	20.6
Arm Height	24¾					Arm Cubic Ft.	22.6

- Polyurethane arm caps are standard. Wood arm cap option available for a \$55 list upcharge per cap
- Soft glide option available for a \$26 list upcharge

Three Seat Bench

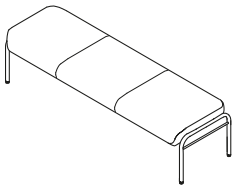

Armless

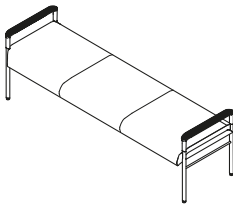

Arms

		1	2/COM	3/COL	4	6	7	L7	L8
N78D3M	Armless	\$ 1576	1627	1651	1686	1796	1886	2320	2458
N78D3A	Arms	1997	2048	2072	2107	2217	2307	2741	2879

Dimensions

Width	67	Seat Height	18¾	Arm Height	24¾	Armless Weight	75
Depth	22½	Seat Depth	22½			Arm Weight	80
Armless Height	18¾	Seat Width	63			Armless Cubic Ft.	29.7
Arm Height	24¾					Arm Cubic Ft.	32.1

- Polyurethane arm caps are standard. Wood arm cap option available for a \$55 list upcharge per cap
- Soft glide option available for a \$26 list upcharge

Confide

To Order, Specify:

1. Model Number
 2. Finish/Laminate Designator
 3. Frame Color
 4. Glides (when applicable)
- See page 99 for Confide options

Ganging End Table

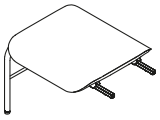

Model No. Grade / List Price

N78TEW	Wood	\$ 1014
N78TEL	Laminate	1014

Dimensions

Width	22	Weight	15
Depth	21¼	Cubic Ft.	8.2
Height	16⅝		

- Soft glide option available for a \$26 list upcharge

Ganging Corner Table

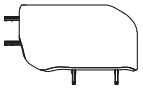

N78TNW	Wood	\$ 1576
N78TNL	Laminate	1576

Dimensions

Width	42	Weight	30
Depth	32	Cubic Ft.	13.2
Height	16⅝		

Ganging Center Table

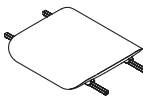

N78TCW	Wood	\$ 985
N78TCL	Laminate	985

Dimensions

Width	22	Weight	15
Depth	21¼	Cubic Ft.	1.7
Height	16⅝		

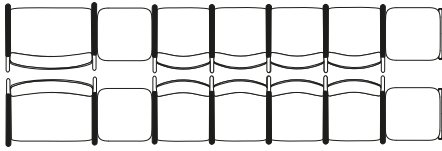

- 2) N78GEAU Bariatric Guest
- 2) N78TCW Ganging Center Table
- 2) N78AFRAU Add-On with Arm – Right
- 2) N78T3AU Three Seat Tandem
- 2) N78TEW Ganging End Table

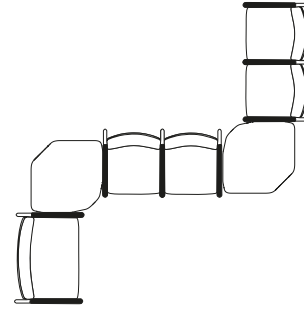

- 1) N78GEAU Bariatric Guest
- 2) N78B2AU Two Seat Tandem, Arms, No Center Leg
- 2) N78TNL Ganging Corner Table

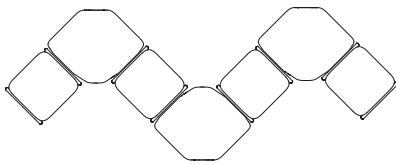

- 4) N78D1M One Seat Bench
- 3) N78TNW Ganging Corner Table

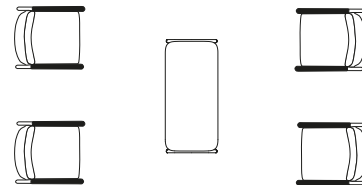

- 4) N78GFAU Guest with Arms
- 1) N78B3EU Three Seat Tandem, No Center Arms or Legs
- 1) N78SMW Magazine Table

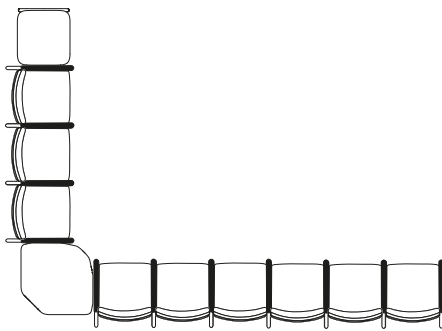
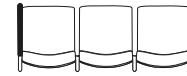

- 1) N78TEW Ganging End Table
- 1) N78T3AW Three Seat Tandem
- 1) N78TNW Ganging Corner Table
- 1) N78SFAW Starter with Arms
- 5) N78AFRAW Add-On with Arms – Right

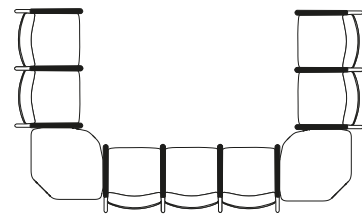

- 2) N78T2AU Two Seat Tandem
- 2) N78TNL Ganging Corner Table
- 1) N78T3AU Three Seat Tandem

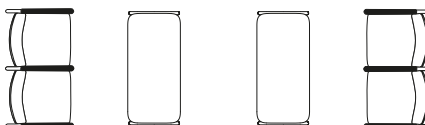

- 4) N78SFAW Starter with Arms
- 3) N78TCW Ganging Center Table
- 2) N78T2AW Two Seat Tandem
- 2) N78SMW Magazine Table

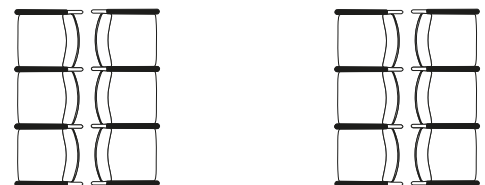

- 4) N78T3AU Three Seat Tandem

Davari®

Davari

DAVARI PRODUCT SPECIFICATIONS

N48 Series

GUEST SEATING

FRAME CONSTRUCTION

- Constructed of exterior steam bent beech with mortise and tenon joints that are securely glued for maximum joint stability
- Features an interior metal support frame for added strength
- Wall saving design feature on back legs
- Non-marring nylon glides

SEAT CONSTRUCTION

- 2" of custom molded, controlled density polyurethane foam covers a plywood panel with high tension strip webbing for comfort

BACK CONSTRUCTION

- 1¼" high grade polyurethane foam covers a contoured plywood panel for added support and comfort

CONTRASTING FABRICS

- Available with contrasting fabric

FINISH

- Wood components feature a catalyzed top coat that resists denting, peeling and reactions to chemicals
- Can be cleaned with damp cloth
- When specifying Brighton and Natural finish, variation in color is acceptable due to the nature of beech wood characteristics
- Features our silver ion antimicrobial finish which inhibits the growth of bacteria and microbes

WOOD SPECIES

- Beech

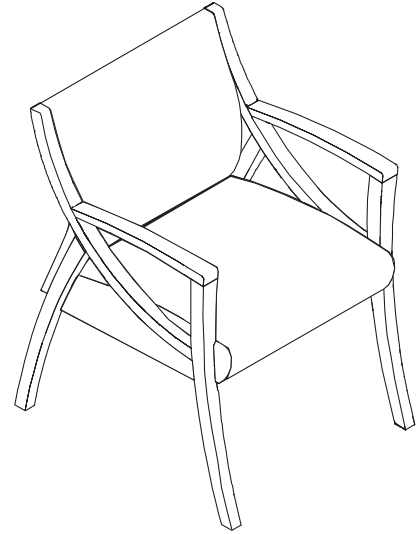

All Davari models may be ordered to meet TB133 fire code.

To order seating to meet the TB133 fire code, specify an "F" at the end of the model number (Ex: N48GFAP).

Reference pages 465-493 for TB133 Fabric Matrix and pricing.

Please consult customer service for applicable Arc-Com, COM, Maharam, Momentum, Stinson or Ultrafabrics fabric.



For comprehensive sustainability information that includes LEED® point contribution, visit NationalOfficeFurniture.ecoScorecard.com.

FABRICS

Grade 1 American Graffiti
 Cali
 Plush
 Ridge
 Speedway
 Stardust

Grade 2 Cathedral
 COM
 Orbit
 Pixie
 Sedona
 Shenanigans
 Spectrum
 Strand
 Tranquility
 Twilight

Grade 3 Boardwalk
 COL
 Jacks
 Pop Rocks

Grade 4 Big City
 Bumble
 Connect Four
 Echo
 Silvertex

Grade 6 Essence/Ultraleather
 Flock
 Scribe

Grade 7 Brisa
 Brisa Distressed
 Promessa
 Silica

Grade L7 Davenport

Grade L8 Showcase

FINISHES

IM Brighton	CW Cordovan
NM Natural	DW Judicial
HN Honey	MH Mocha
CL Caramel	405 Designer White
TF Truffle	462 Cinder
AC Autumn	792 Sable
MC Amber	793 Acorn

To You In
10 DAYS
...or Less

Shaded model numbers are available on our "To You in 10 Days or Less" Quick Delivery program and will be delivered within 10 days.

To Order, Specify:

1. Model Number
2. Fabric Grade Number
3. Cover Number
4. Finish Designator

• See page 117 for Davari options

Davari

Arm

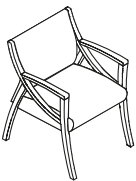

Model No.

Grade / List Price

Quick Delivery Model: QN48GFA

	1	2/COM	3/COL	4	6	7	L7	L8
N48GFA	\$ 1271	1310	1329	1356	1441	1511	1846	1953

Dimensions

Width	23¾	Seat Height	18	Arm Height	26	Weight	39
Depth	26½	Seat Depth	17½	Back Height	14½	Cubic Ft.	16.8
Height	32¾	Seat Width	20%	Back Width	20%		

• Contrasting fabric option – specify X (i.e., N48GFAX); see below. For list pricing, use your electronic specification tool or contact customer service

Armless

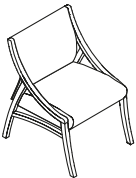

Quick Delivery Model: QN48GFM

	1	2/COM	3/COL	4	6	7	L7	L8
N48GFM	\$ 1204	1243	1262	1289	1374	1444	1779	1886

Dimensions

Width	23¾	Seat Height	18	Back Height	14½	Weight	38
Depth	26½	Seat Depth	17½	Back Width	20%	Cubic Ft.	16.8
Height	32¾	Seat Width	20%				

• Contrasting fabric option – specify X (i.e., N48GFMX); see below. For list pricing, use your electronic specification tool or contact customer service

To Order Contrasting Fabric, Specify:

1. Model Number plus "X"
2. Back Fabric Grade Number/Cover Number
3. Extreme Back Fabric Grade Number/Cover Number
4. Seat Fabric Grade Number/Cover Number
5. Finish Designator

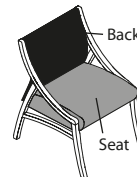

Contrasting



Contrasting Back View

Ditto™

Ditto

DITTO PRODUCT SPECIFICATIONS

36 Series

FRAME CONSTRUCTION

- Sled base frame legs are made of $\frac{5}{8}$ " thick steel for strength and durability
- Cross members are constructed of $1\frac{1}{2}$ " x $\frac{1}{8}$ " 15-gauge thick steel
- Legs are joined to cross member bars with metal inert gas (MIG) welds

STOOL FRAME CONSTRUCTION

- Frame legs are made of $\frac{3}{4}$ " thick steel for strength and durability
- Cross members are constructed of $1\frac{1}{2}$ " x $\frac{1}{8}$ " 15-gauge thick steel
- Legs are joined to cross member bars with metal inert gas (MIG) welds

BACK AND SEAT CONSTRUCTION

- Contoured, injection molded polypropylene seat and back
- Seats and back are attached to the frame with screws

GLIDES

- Durable hard black nylon glides are standard
- Glides are ganging on guest chair, stool model is non-ganging
- Soft clear non-ganging glide option available for an upcharge

FINISH

- Polished aluminum

TRANSPORT DOLLY

- $\frac{3}{4}$ " x 14-gauge tubular steel
- 3" locking casters
- Black electrostatically backed-on powder coat paint is standard
- Some assembly required

STACKING CAPABILITIES

- Guest models can be stacked up to 25 high on transport dolly
- Guest models can be stacked up to 8 high on the floor

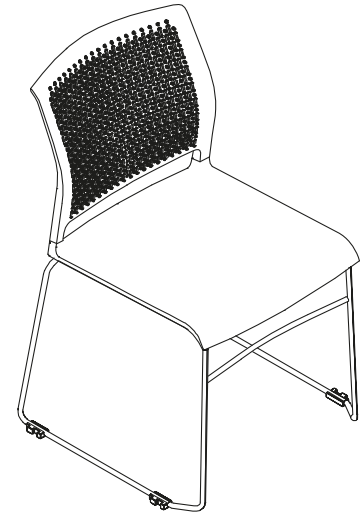

For comprehensive sustainability information that includes LEED® point contribution, visit NationalOfficeFurniture.ecoScorecard.com.

All Ditto models may be ordered to meet TB133 fire code.

BACK/SEAT COLORS

201 White
202 Light Grey
204 Taupe
205 Red
206 Blue
208 Black
209 Orange

- Guest stacker in black and white is available for ordering on October 19, 2015; all other colors and stool models will be available November 16, 2015

GLIDES

STD Hard (standard)
C56 Soft (add \$14 list per chair)

Ditto

To You In
10 DAYS
...or Less

Shaded model numbers are available on our "To You in 10 Days or Less" Quick Delivery program and will be delivered within 10 days.

To Order, Specify:

1. Model Number
 2. Back/Seat Color
 3. Glides
- See page 121 for Ditto options

Guest Stacker



Model No. **Grade / List Price**

Quick Delivery Models: QN36GM, QN36G4M

N36GM	Package of 1	\$ 242
N36G4M	Package of 4	752

Dimensions

Width	22¼	Seat Height	18¾	Back Height	17¼	Weight (1)	27
Depth	21½	Seat Depth	17½	Back Width	17%	Cubic Ft. (1)	16.7
Height	33¾	Seat Width	18			Weight (4)	69
						Cubic Ft. (4)	17.3

- Soft non-ganging glide option available for a \$14 list upcharge per chair

Stool

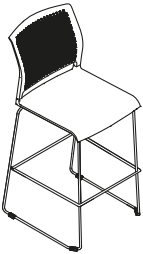

Quick Delivery Models: QN36SM, QN36S2M

N36SM	Package of 1	\$ 361
N36S2M	Package of 2	670

Dimensions

Width	21¼	Seat Height	30¼	Back Height	17¼	Weight (1)	31
Depth	22¾	Seat Depth	17½	Back Width	17%	Cubic Ft. (1)	17.2
Height	45	Seat Width	18			Weight (2)	50
						Cubic Ft. (2)	19.2

- Soft non-ganging glide option available for a \$14 list upcharge per chair

Transport Dolly

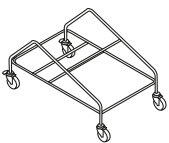

N36TD	Black	\$ 424
--------------	-------	---------------

Dimensions

Width	26	Weight	29
Depth	42	Cubic Ft.	10.6
Height	21¾		

Eloquence®

Eloquence

ELOQUENCE PRODUCT SPECIFICATIONS—GUEST, TANDEM, BARIATRIC, GANGING TABLES 85 Series

FRAME CONSTRUCTION

- Constructed of beech with mortise and tenon joints on top rail and doweled joints on front and back rails
- Each joint is securely glued for maximum joint stability
- Features back legs cut from steam bent beech wood
- Non-marring nylon glides

ARMS

- Available with black protective polyurethane arm caps for added durability

SEAT CONSTRUCTION (N85SA, N85SB, N85SC, N85SAA, N85SAAA, N85SCA)

- 2" of high grade polyurethane foam covers a plywood panel with high tension strip webbing for comfort
- Corner blocks are screwed and glued in all four corners of the seat

SEAT CONSTRUCTION (N85SE)

- 2" of high grade polyurethane foam covers a solid seat panel
- Corner blocks are screwed and glued in all four corners of the seat

BACK CONSTRUCTION (ALL MODELS)

- $\frac{3}{4}$ " of high grade polyurethane foam covers the front of a contoured panel for support and comfort
- The outer (extreme) back features $\frac{1}{4}$ " of high grade polyurethane foam

CONTRASTING FABRICS

- Guest and tandem seating available with contrasting fabric

FINISH

- Features a catalyzed top coat that resists denting, peeling and reactions to chemicals
- Can be cleaned with a damp cloth
- When specifying Brighton and Natural finish, variation in color is acceptable due to the nature of beech wood characteristics
- Features our silver ion antimicrobial finish which inhibits the growth of bacteria and microbes

WOOD SPECIES

- Beech

TABLES

- Veneer models feature $\frac{3}{4}$ " grade A, slipmatched, European beech veneer tops with European beech facade rails and legs
- Laminate models feature $\frac{3}{4}$ " particle board with laminate (HPL) top and European beech facade rails and legs

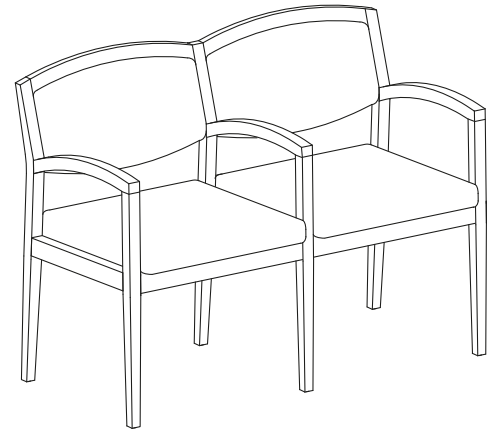

For comprehensive sustainability information that includes LEED® point contribution, visit NationalOfficeFurniture.ecoScorecard.com.

All Eloquence models may be ordered to meet TB133 fire code.

To order seating to meet the TB133 fire code, specify an "F" at the end of the model number (Ex: N85CACF).

Reference pages 465-493 for TB133 Fabric Matrix and pricing.

Please consult customer service for applicable Arc-Com, COM, Maharam, Momentum, Stinson or Ultrafabrics fabric.

FABRICS

Grade 1	American Graffiti
	Cali
	Plush
	Ridge
	Speedway
Grade 2	Stardust
	Cathedral
	COM
	Orbit
	Pixie
	Sedona
	Shenanigans
	Spectrum
Strand	
Tranquility	
Twilight	

Grade 3	Boardwalk
	COL
	Jacks
Grade 4	Pop Rocks
	Big City
	Bumble
	Connect Four
	Echo
Grade 6	Silvertex
	Essence/Ultraleather
	Flock
	Scribe

Grade 7	Brisa
	Brisa Distressed
	Promessa
	Silica
Grade L7	Davenport
Grade L8	Showcase

FINISHES

IM	Brighton	CW	Cordovan
NM	Natural	DW	Judicial
HN	Honey	MH	Mocha
CL	Caramel	405	Designer White
TF	Truffle	462	Cinder
AC	Autumn	792	Sable
MC	Amber	793	Acorn

LAMINATES

Tables Only

IM	Brighton	MH	Mocha
NM	Natural	405	Designer White
HN2	Honey 2	462	Cinder
CL	Caramel	*791NM	Palisander/Natural
TF	Truffle	*791HN	Palisander/Honey
AC2	Autumn 2	*791MH	Palisander/Mocha
MC	Amber	792	Sable
CW	Cordovan	793	Acorn
DW	Judicial		

*Palisander laminate table tops will have (NM) Natural, (HN) Honey or (MH) Mocha legs

Eloquence

To You In 10 DAYS ...or Less
 Shaded model numbers are available on our "To You in 10 Days or Less" Quick Delivery program and will be delivered within 10 days.

To Order, Specify:

1. Model Number
2. Fabric Grade Number
3. Cover Number
4. Finish Designator

• See page 125 for Eloquence options

Guest Half Upholstered Back



Polyurethane Arm Caps

Model No.

Grade / List Price

Quick Delivery Model: QN85SA

		1	2/COM	3/COL	4	6	7	L7	L8
N85SA		\$ 869	887	896	909	949	982	1139	1190
N85SAT	Black Polyurethane Arm Caps	955	973	982	995	1035	1068	1225	1276

Dimensions

Width	22 ¹⁵ / ₁₆	Seat Height	19 ¹ / ₂	Arm Height	27 ³ / ₈	Weight	18
Depth	22 ¹ / ₂	Seat Depth	18	Back Height	14 ²⁹ / ₃₂	Cubic Ft.	15.5
Height	34 ¹ / ₄	Seat Width	20 ¹ / ₄	Back Width	20 ¹ / ₄		

• Contrasting fabric option – specify X (i.e., N85SAX). For list pricing, use your electronic specification tool or contact customer service

Guest Fully Upholstered Back



Polyurethane Arm Caps

Quick Delivery Model: QN85SB

		1	2/COM	3/COL	4	6	7	L7	L8
N85SB		\$ 920	945	957	975	1030	1075	1292	1361
N85SBT	Black Polyurethane Arm Caps	1005	1030	1042	1060	1115	1160	1377	1446

Dimensions

Width	22 ¹⁵ / ₁₆	Seat Height	19 ¹ / ₂	Arm Height	27 ³ / ₈	Weight	18
Depth	22 ¹ / ₂	Seat Depth	18	Back Height	14 ²⁹ / ₃₂	Cubic Ft.	15.5
Height	34 ¹ / ₄	Seat Width	20 ¹ / ₄	Back Width	20 ¹ / ₄		

• Contrasting fabric option – specify X (i.e., N85SBX). For list pricing, use your electronic specification tool or contact customer service

To Order Contrasting Fabric, Specify:

1. Model Number plus "X"
2. Back Fabric Grade Number/Cover Number
3. Seat Fabric Grade Number/Cover Number
4. Finish Color

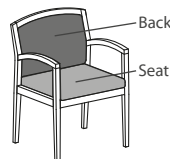

Contrasting Fabric

Guest Wood Back



Polyurethane Arm Caps

Model No.

Grade / List Price

		1	2/COM	3/COL	4	6	7	L7	L8
N855C		\$ 938	956	965	978	1018	1051	1208	1259
N855CT	Black Polyurethane Arm Caps	1025	1043	1052	1065	1105	1138	1295	1346

Dimensions

Width	22 ¹ / ₁₆	Seat Height	19 ¹ / ₂	Arm Height	27 ³ / ₈	Weight	18
Depth	22 ¹ / ₂	Seat Depth	18	Back Height	14 ²⁹ / ₃₂	Cubic Ft.	15.5
Height	34 ¹ / ₄	Seat Width	20 ¹ / ₄	Back Width	20 ¹ / ₄		

Guest Bariatric Fully Upholstered Back

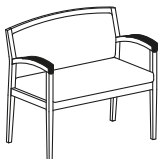
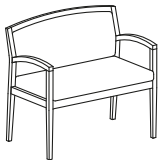

Polyurethane Arm Caps

		1	2/COM	3/COL	4	6	7	L7	L8
N855E		\$ 1635	1679	1700	1730	1825	1903	2277	2397
N855ET	Black Polyurethane Arm Caps	1722	1766	1787	1817	1912	1990	2364	2484

Dimensions

Width	35 ³ / ₄	Seat Height	19 ¹ / ₂	Arm Height	27 ³ / ₈	Weight	33
Depth	22 ¹ / ₂	Seat Depth	18	Back Height	14 ²⁹ / ₃₂	Cubic Ft.	24.5
Height	34 ¹ / ₄	Seat Width	33	Back Width	33		

- Tested to and meets 500 lbs. weight load
- Contrasting fabric option – specify X (i.e., N85SEX). For list pricing, use your electronic specification tool or contact customer service

To Order Contrasting Fabric, Specify:

1. Model Number plus “X”
2. Back Fabric Grade Number/Cover Number
3. Seat Fabric Grade Number/Cover Number
4. Finish Color

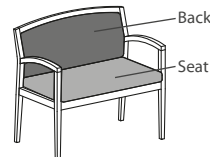

Contrasting Fabric

Chair Ganging Bracket

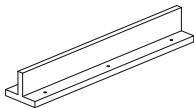

Quick Delivery Model: QN85SJ

N85SJ	Wood	\$ 64
--------------	------	-------

Dimensions

Width	3 ³ / ₁₆	Weight	3
Depth	17 ⁵ / ₁₆	Cubic Ft.	0.6
Height	2 ¹⁵ / ₃₂		

- Some assembly required
- Wood bracket attaches under seat rail
- Separates adjoining chairs by 1/2"

Eloquence

To You In 10 Days...or Less
 Shaded model numbers are available on our "To You in 10 Days or Less" Quick Delivery program and will be delivered within 10 days.

To Order, Specify:

1. Model Number
 2. Fabric Grade Number
 3. Cover Number
 4. Finish/Laminate Designator
- See page 125 for Eloquence options

Tandem Two Seat Half Upholstered Back

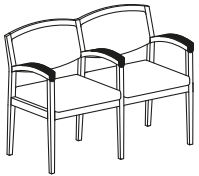
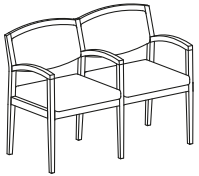

Polyurethane Arm Caps

Model No. Grade / List Price

Quick Delivery Model: QN85SAA

	1	2/COM	3/COL	4	6	7	L7	L8
N85SAA	\$ 1591	1628	1645	1671	1751	1817	2132	2233
N85SAAAT Black Polyurethane Arm Caps	1721	1758	1775	1801	1881	1947	2262	2363

Dimensions

Width	44 ¹⁷ / ₃₂	Seat Height	19 ¹ / ₂	Arm Height	27 ³ / ₈	Weight	36
Depth	22 ¹ / ₂	Seat Depth	18	Back Height	14 ²⁹ / ₃₂	Cubic Ft.	26.0
Height	34 ¹ / ₄	Seat Width	20 ¹ / ₄	Back Width	20 ¹ / ₄		

- Contrasting fabric option – specify X (i.e., N85SAAAX). For list pricing, use your electronic specification tool or contact customer service

Tandem Three Seat Half Upholstered Back

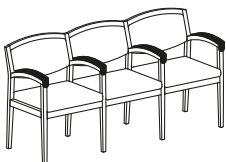
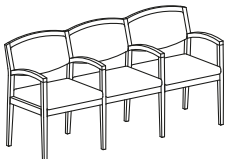

Polyurethane Arm Caps

Quick Delivery Model: QN85SAAA

	1	2/COM	3/COL	4	6	7	L7	L8
N85SAAA	\$ 2387	2445	2472	2512	2637	2740	3232	3390
N85SAAAAT Black Polyurethane Arm Caps	2559	2617	2644	2684	2809	2912	3404	3562

Dimensions

Width	66 ³ / ₈	Seat Height	19 ¹ / ₂	Arm Height	27 ³ / ₈	Weight	48
Depth	22 ¹ / ₂	Seat Depth	18	Back Height	14 ²⁹ / ₃₂	Cubic Ft.	37.6
Height	34 ¹ / ₄	Seat Width	20 ¹ / ₄	Back Width	20 ¹ / ₄		

- Contrasting fabric option – specify X (i.e., N85SAAAX). For list pricing, use your electronic specification tool or contact customer service

To Order Contrasting Fabric, Specify:

1. Model Number plus "X"
2. Back Fabric Grade Number/Cover Number
3. Seat Fabric Grade Number/Cover Number
4. Finish Color

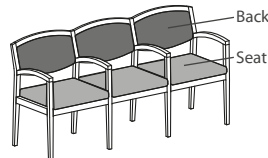

Contrasting Fabric

**Tandem
Three Seat
Wood, Half Upholstered**

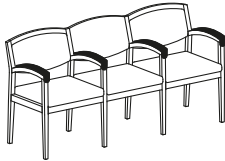
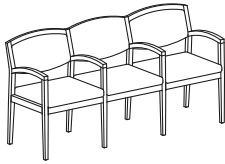

Polyurethane Arm Caps

Model No.

Grade / List Price

		1	2/COM	3/COL	4	6	7	L7	L8
N85SACA		\$ 2456	2511	2538	2576	2696	2794	3267	3418
N85SACAT	Black Polyurethane Arm Caps	2628	2683	2710	2748	2868	2966	3439	3590

Dimensions

Width	66 ¹ / ₆	Seat Height	19 ¹ / ₂	Arm Height	27 ³ / ₈	Weight	48
Depth	22 ¹ / ₂	Seat Depth	18	Back Height	14 ² / ₃	Cubic Ft.	37.6
Height	34 ¹ / ₄	Seat Width	20 ¹ / ₄	Back Width	20 ¹ / ₄		

- Wood back is featured as center chair
- Contrasting fabric option – specify X (i.e., N85SACAX). For list pricing, use your electronic specification tool or contact customer service

To Order Contrasting Fabric, Specify:

1. Model Number plus “X”
2. Back Fabric Grade Number/Cover Number
3. Seat Fabric Grade Number/Cover Number
4. Finish Color

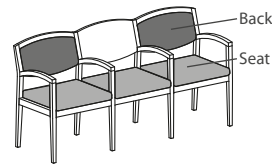

Contrasting Fabric

**Gangung
Center Table**

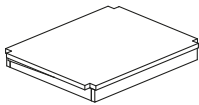

Quick Delivery Model: QN85SG

N85SG	Wood Top	\$ 692
N85SGLW	Laminate Top	692

Dimensions

Width	24 ³ / ₁₆	Weight	14
Depth	19 ¹ / ₁₆	Cubic Ft.	1.4
Height	2 ² / ₃₂		

- Some assembly required
- Notched to fit snugly to adjoining chairs and bariatric seating
- Fastens with u-shaped brackets under side rails of gangung chairs

**Gangung
Corner Table**

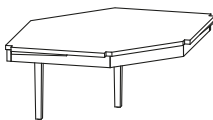

Quick Delivery Model: QN85SH

N85SH	Wood Top	\$ 819
N85SHLW	Laminate Top	819

Dimensions

Width	41 ² / ₃₂	Weight	25
Depth	26 ¹ / ₃₂	Cubic Ft.	2.7
Height	17 ³ / ₈		

- Some assembly required
- Notched to fit snugly to adjoining chairs and bariatric seating
- Fastens with u-shaped brackets under side rails of gangung chairs

Eloquence

ELOQUENCE PRODUCT SPECIFICATIONS—LOUNGE, FREESTANDING TABLES 85 Series

FRAME CONSTRUCTION

- Interior frame is constructed of plywood with tenon joints that are glued and screwed for maximum joint stability
- Exterior frame is constructed of beech with mortise and tenon joints
- Each joint is securely glued for maximum joint stability
- Non-marring nylon glides

SEAT CONSTRUCTION

- 4" of high grade polyurethane foam covers a plywood panel with high tension strip webbing for comfort

BACK CONSTRUCTION

- 2" of high grade polyurethane foam which is stretched over web sheet and attached to frame

ARM CONSTRUCTION

- ¼" of high grade polyurethane foam covers both the interior and exterior upholstery panel
- Available with black protective polyurethane arm caps for added durability

CONTRASTING FABRICS

- Available with contrasting fabric locations: back, seat, and arms/outer back

FINISH

- Features a catalyzed top coat that resists denting, peeling and reactions to chemicals
- Can be cleaned with a damp cloth
- When specifying Brighton and Natural finish, variation in color is acceptable due to the nature of beech wood characteristics
- Features our silver ion antimicrobial finish which inhibits the growth of bacteria and microbes

WOOD SPECIES

- Beech

TABLES

- Veneer models feature ¾" grade A, slipmatched, European beech veneer tops with European beech facade rails and legs
- Laminate models feature ¾" particle board with laminate (HPL) top and European beech facade rails and legs

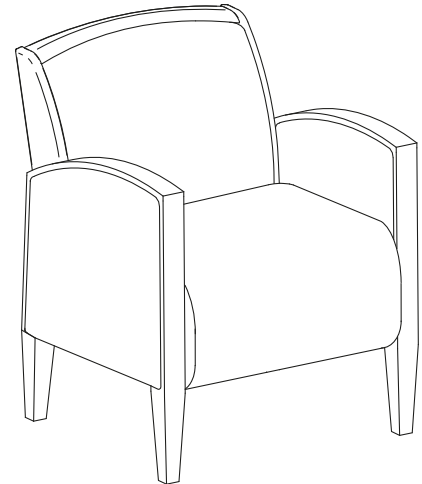

For comprehensive sustainability information that includes LEED® point contribution, visit NationalOfficeFurniture.ecoScorecard.com.

All Eloquence models may be ordered to meet TB133 fire code.

To order seating to meet the TB133 fire code, specify an "F" at the end of the model number (Ex: N85CACF).

Reference pages 465-493 for TB133 Fabric Matrix and pricing.

Please consult customer service for applicable Arc-Com, COM, Maharam, Momentum, Stinson or Ultrafabrics fabric.

FABRICS

Grade 1	American Graffiti
	Cali
	Plush
	Ridge
	Speedway
Grade 2	Stardust
	Cathedral
	COM
	Orbit
	Pixie
	Sedona
	Shenanigans
	Spectrum
Strand	
Tranquility	
Twilight	

Grade 3	Boardwalk
	COL
	Jacks
Grade 4	Pop Rocks
	Big City
	Bumble
	Connect Four
	Echo
Grade 6	Silvertex
	Essence/Ultraleather
	Flock
	Scribe

Grade 7	Brisa
	Brisa Distressed
	Promessa
	Silica
Grade L7	Davenport
Grade L8	Showcase

FINISHES

IM	Brighton	CW	Cordovan
NM	Natural	DW	Judicial
HN	Honey	MH	Mocha
CL	Caramel	405	Designer White
TF	Truffle	462	Cinder
AC	Autumn	792	Sable
MC	Amber	793	Acorn

LAMINATES

Tables Only

IM	Brighton	MH	Mocha
NM	Natural	405	Designer White
HN2	Honey 2	462	Cinder
CL	Caramel	*791NM	Palisander/Natural
TF	Truffle	*791HN	Palisander/Honey
AC2	Autumn 2	*791MH	Palisander/Mocha
MC	Amber	792	Sable
CW	Cordovan	793	Acorn
DW	Judicial		

*Palisander laminate table tops will have (NM) Natural, (HN) Honey or (MH) Mocha legs

To Order, Specify:

1. Model Number
2. Fabric Grade Number
3. Cover Number
4. Finish Designator

• See page 131 for Eloquence options

One Seat Lounge



Polyurethane Arm Caps

Model No.	Grade / List Price							
	1	2/COM	3/COL	4	6	7	L7	L8
N85LA	\$ 2051	2115	2146	2191	2331	2446	2997	3174
N85LAT Black Polyurethane Arm Caps	2168	2232	2263	2308	2448	2563	3114	3291

Dimensions

Width	27	Seat Height	19	Arm Height	27½	Weight	79
Depth	28¾	Seat Depth	19			Cubic Ft.	20.3
Height	34	Seat Width	22				

- Contrasting fabric option – specify X (i.e., N85LAX). For list pricing, use your electronic specification tool or contact customer service

Two Seat Lounge

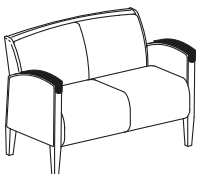
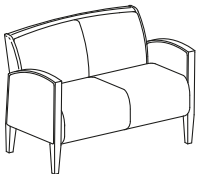

Polyurethane Arm Caps

Model No.	Grade / List Price							
	1	2/COM	3/COL	4	6	7	L7	L8
N85LB	\$ 2594	2687	2731	2796	2997	3162	3956	4210
N85LBT Black Polyurethane Arm Caps	2711	2804	2848	2913	3114	3279	4073	4327

Dimensions

Width	47¾	Seat Height	19	Arm Height	27½	Weight	105
Depth	28¾	Seat Depth	19			Cubic Ft.	34.7
Height	34	Seat Width	42½				

- Cushion is one piece with stitching
- Contrasting fabric option – specify X (i.e., N85LBX). For list pricing, use your electronic specification tool or contact customer service

To Order Contrasting Fabric, Specify:

1. Model Number plus "X"
2. Back Fabric Grade Number/Cover Number
3. Seat Fabric Grade Number/Cover Number
4. Arms/Outer Back Grade Number
5. Arms/Outer Back Cover Number
6. Finish Color

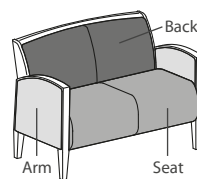

Contrasting Fabric

Three Seat Lounge

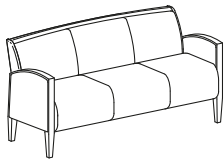

Polyurethane Arm Caps

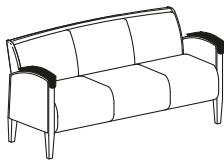

Model No.

Grade / List Price

		1	2/COM	3/COL	4	6	7	L7	L8
N85LC		\$ 3199	3319	3376	3459	3719	3932	4957	5284
N85LCT	Black Polyurethane Arm Caps	3317	3437	3494	3577	3837	4050	5075	5402

Dimensions

Width	68	Seat Height	19	Arm Height	27½	Weight	135
Depth	28¾	Seat Depth	19			Cubic Ft.	49.1
Height	34	Seat Width	62¾				

- Cushion is one piece with stitching
- Contrasting fabric option – specify X (i.e., N85LCX). For list pricing, use your electronic specification tool or contact customer service

To Order Contrasting Fabric, Specify:

1. Model Number plus “X”
2. Back Fabric Grade Number/Cover Number
3. Seat Fabric Grade Number/Cover Number
4. Arms/Outer Back Grade Number
5. Arms/Outer Back Cover Number
6. Finish Color

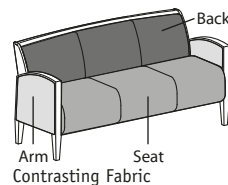

Lounge Bench

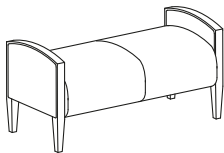

Polyurethane Arm Caps

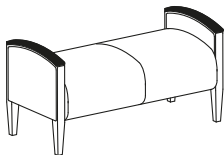

		1	2/COM	3/COL	4	6	7	L7	L8
N85LD		\$ 1638	1696	1723	1763	1888	1991	2483	2641
N85LDT	Black Polyurethane Arm Caps	1755	1813	1840	1880	2005	2108	2600	2758

Dimensions

Width	50¼	Seat Height	20¼	Arm Height	24¾	Weight	56
Depth	24¾	Seat Depth	24¾			Cubic Ft.	23.4
Height	24¾	Seat Width	45				

- Cushion is one piece with stitching
- Contrasting fabric option – specify X (i.e., N85LDX). For list pricing, use your electronic specification tool or contact customer service

To Order Contrasting Fabric, Specify:

1. Model Number plus “X”
2. Seat Fabric Grade Number/Cover Number
3. Arm Fabric Grade Number/Cover Number
4. Finish Color

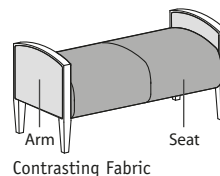

Personal Pull-up Table



10N1622RTPUW	Wood	\$ 955
10N1622RTPUL	Laminate	955

Dimensions

Width	22	Weight	32
Depth	13¾	Cubic Ft.	9.25
Height	28½		

- 50 lb. weight limit
- Specify metal finish (462) Cinder, (501) Platinum Metallic, or (503) Satin Nickel Metallic
- Specify laminate or wood finish; **Laminates** (NM) Natural, (HN2) Honey 2, (CL) Caramel, (TF) Truffle, (AC2) Autumn 2, (MC) Amber, (CW) Cordovan, (DW) Judicial, (MH) Mocha, (405) Designer White, (462) Cinder, (791) Palisander, (792) Sable, or (793) Acorn; **Wood Finishes** (NM) Natural, (HN) Honey, (CL) Caramel, (TF) Truffle, (AC) Autumn, (MC) Amber, (CW) Cordovan, (DW) Judicial, (MH) Mocha, (405) Designer White, (462) Cinder, (792) Sable, or (793) Acorn

To Order, Specify:

1. Model Number
 2. Finish/Laminate Designator
- See page 131 for Eloquence options

End Table

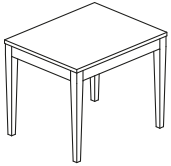

Model No. **Grade / List Price**

85N2024EN	Wood Top	\$ 819
85N2024ENLW	Laminate Top	819

Dimensions

Width	21½ ³²	Weight	19
Depth	24 ⁹ / ₁₆	Cubic Ft.	1.4
Height	20 ⁵ / ₈		

- Some assembly required

Magazine Table

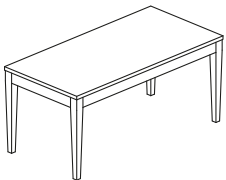

85N2040MG	Wood Top	\$ 943
85N2040MGLW	Laminate Top	943

Dimensions

Width	39 ⁵ / ₈	Weight	26
Depth	19 ⁷ / ₃₂	Cubic Ft.	2.2
Height	18 ⁵ / ₃₂		

- Some assembly required

Eloquence

ELOQUENCE PRODUCT SPECIFICATIONS—EXECUTIVE

85 Series

SEAT AND BACK CONSTRUCTION

- 11-ply, one piece solid molded plywood shell forms the seat and back
- 3" of high density foam covers the seat and 2½" of high density foam covers the back

ARM CONSTRUCTION

- Constructed of exterior beech with doweled and barrel nut joints
- Arms are attached to the seat and back with metal L-brackets
- Available with black protective polyurethane arm caps for added durability

CONTROL MECHANISM/LIFT

- The standard knee tilt mechanism features a heavy-duty adjustment tension spring for a variety of body sizes and minimal rise of front seat edge; this allows the user's feet to remain planted when the chair is in the reclining position
- The combination gas lift/tilt lock lever allows dual functions with a simple in/out movement for lockout and an up/down movement for height adjustment

BASE AND CASTERS

- Wood base features a standard five prong, rigid steel understructure to ensure long life
- Caster posts fit directly into steel sleeves, greatly reducing caster socket failure
- Decorative hardwood caps complement the chair design
- Black, hard double wheel casters, which work on multiple surfaces, are standard
- Black, soft double wheel casters are available for use on hard floors; upcharge applies to this option
- All National bases are tested to BIFMA standards using 2500 lb. force

FINISH

- Features a catalyzed top coat that resists denting, peeling and reactions to chemicals
- Can be cleaned with a damp cloth
- When specifying Brighton and Natural finish, variation in color is acceptable due to the nature of beech wood characteristics
- Features our silver ion antimicrobial finish which inhibits the growth of bacteria and microbes

WOOD SPECIES

- Beech



All Eloquence models may be ordered to meet TB133 fire code.

To order seating to meet the TB133 fire code, specify an "F" at the end of the model number (Ex: N85CACF).

Reference pages 465-493 for TB133 Fabric Matrix and pricing.

Please consult customer service for applicable Arc-Com, COM, Maharam, Momentum, Stinson or Ultrafabrics fabric.



For comprehensive sustainability information that includes LEED® point contribution, visit NationalOfficeFurniture.ecoScorecard.com.

FABRICS

Grade 1	American Graffiti
	Cali
	Plush
	Ridge
	Speedway
Grade 2	Stardust
	Cathedral
	COM
	Orbit
	Pixie
	Sedona
	Shenanigans
	Spectrum
Strand	
Tranquility	
Twilight	

Grade 3	Boardwalk
	COL
	Jacks
	Pop Rocks
Grade 4	Big City
	Bumble
	Connect Four
	Echo
Grade 6	Silvertex
	Essence/Ultraleather
	Flock
Scribe	

Grade 7	Brisa
	Brisa Distressed
	Promessa
	Silica
Grade L7	Davenport
Grade L8	Showcase

FINISHES

IM	Brighton	CW	Cordovan
NM	Natural	DW	Judicial
HN	Honey	MH	Mocha
CL	Caramel	405	Designer White
TF	Truffle	462	Cinder
AC	Autumn	792	Sable
MC	Amber	793	Acorn

CASTERS

C3	Hard (standard)
C4	Soft (add \$24 list)

To Order, Specify:

1. Model Number
2. Fabric Grade Number
3. Cover Number
4. Finish Designator
5. Casters

• See page 137 for Eloquence options

High Back



Model No.	Grade / List Price								
		1	2/COM	3/COL	4	6	7	L7	L8
N85CAC	Black Polyurethane Arm Caps	\$ 1308	1347	1366	1393	1478	1548	1883	1990
Dimensions									
Width	27¼	Seat Height	18¼-23	Arm Height	27¼-32¼	Weight	45		
Depth	28	Seat Depth	18¼			Cubic Ft.	20.4		
Height	41½-46¾	Seat Width	22						

Mid Back



Model No.	Grade / List Price								
		1	2/COM	3/COL	4	6	7	L7	L8
N85CBC	Black Polyurethane Arm Caps	\$ 1268	1305	1322	1348	1428	1494	1809	1910
Dimensions									
Width	27	Seat Height	18¼-23	Arm Height	27¼-32¼	Weight	44		
Depth	27¼	Seat Depth	18¼			Cubic Ft.	19.5		
Height	38-43¼	Seat Width	22						

Essay[®]

Essay

ESSAY PRODUCT SPECIFICATIONS

21 Series

SHELL CONSTRUCTION

- Contoured, injection molded polypropylene
- Wall friendly design

UPHOLSTERED SEAT FOAM

- 3/8" foam

4-LEG BASE

- Injection molded glass filled nylon

TRAY

- Injection molded polypropylene

TABLET ARM

- Non-handed chevron shaped worksurface
- Black 3/4" thick thermofoil tablet
- Writing surface 24 3/4" W x 12" D

CUP HOLDER

- Available as an option on tablet models only
- Injection molded polypropylene
- Light assembly required

SWIVEL MECHANISM

- 360° fixed height swivel

CONTROL (TASK/STOOL OPTION)

- Swivel control
- The pneumatic gas cylinder lift allows the seat to raise and lower

CASTER

- Black, hard double wheel casters, which work on multiple surfaces, are standard
- Black, soft double wheel roll control casters, for use on hard surfaces, are available at an upcharge

GLIDES

- Soft glides are available at an upcharge

ASSEMBLY

- Product is shipped ready-to-assemble (student chairs only)
- Three subassemblies join with no tools required

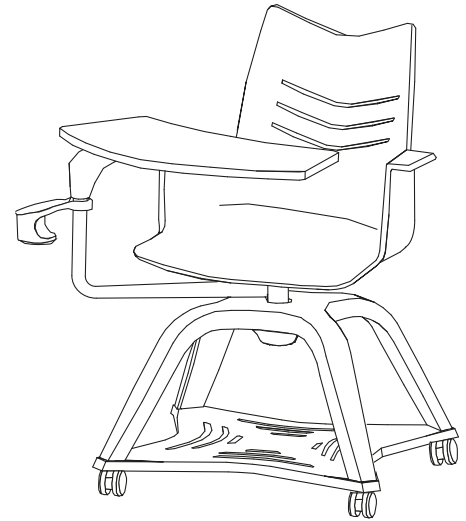

FABRICS

Grade 1	American Graffiti
	Cali
	Plush
	Ridge
	Speedway
Grade 2	Stardust
	Cathedral
	COM
	Orbit
	Pixie
	Sedona
	Shenanigans
	Spectrum
	Strand
Tranquility	
Twilight	

Grade 3	Boardwalk
	COL
	Jacks
	Pop Rocks

Grade 4	Big City
	Bumble
	Connect Four
	Echo
Silvertex	

Grade 6	Essence/Ultraleather
	Flock
	Scribe

Grade 7	Brisa
	Brisa Distressed
	Promessa
	Silica

Grade L7 Davenport

Grade L8 Showcase

STUDENT CHAIR

SHELL AND TRAY COLORS

- 151 White
- 152 Light Grey
- 153 Dark Grey
- 154 Taupe
- 155 Red
- 156 Blue
- 157 Navy
- 158 Black

- Tablet surface is black

FRAME COLOR (TABLET ARM SUPPORT AND BASE)

- 153 Dark Grey
- 158 Black

CUP HOLDER OPTIONS

(\$50 list upcharge)

- CPB Cup Holder, Black
- X No Cup Holder

CASTERS

- C3 Hard (standard)
- C29 Soft (add \$24 list per chair)

GLIDES

- C27 Hard (standard)
- C28 Soft (add \$26 list per chair)

TASK AND TASK STOOLS

SHELL COLORS

- 151 White
- 152 Light Grey
- 153 Dark Grey
- 154 Taupe
- 155 Red
- 156 Blue
- 157 Navy
- 158 Black

- Task chair tablet arm support is black
- Task and task stool chair base is black
- Tablet surface is black

CUP HOLDER OPTIONS

(\$50 list upcharge)

- CPB Cup Holder, Black
- X No Cup Holder

CASTERS

- C3 Hard (standard)
- C29 Soft (add \$24 list per chair)

GLIDES

- C27 Hard (standard)
- C28 Soft (add \$26 list per chair)

To You In 10 Days or Less
 Shaded model numbers are available on our "To You in 10 Days or Less" Quick Delivery program and will be delivered within 10 days.

**Student Chair
 To Order, Specify:**

1. Model Number
 2. Shell Color
 3. Fabric Grade / Cover Number (when applicable)
 4. Tray Color
 5. Frame Color
 6. Cup Holder (when applicable)
 7. Caster or Glide
- See page 141 for Essay options

**Task Chair
 To Order, Specify:**

1. Model Number
 2. Shell Color
 3. Fabric Grade / Cover Number (when applicable)
 4. Cup Holder (when applicable)
 5. Caster or Glide
- See page 141 for Essay options

**Student Chair
 with Tablet**

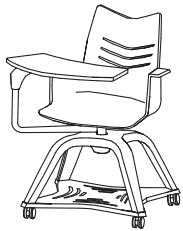

Mobile



Static

**Model
 No.**

Grade / List Price

Quick Delivery Models: QN21AATC, QN21AATUC, QN21AATG, QN21AATUG

		1	2/COM	3/COL	4	6	7	L7	L8
N21AATC	Mobile	\$ 689							
N21AATUC	Upholstered Seat, Mobile	806	822	830	841	876	905	1043	1087
N21AATG	Static	\$ 689							
N21AATUG	Upholstered Seat, Static	806	822	830	841	876	905	1043	1087

Dimensions

Width	26	Seat Height	17¾	Arm Height	27	Weight	55
Depth	33	Seat Depth	17	Back Height	18¼	Upholstered Seat Model Weight	60
Height	36½	Seat Width	19½	Back Width	17	Cubic Ft.	9.5

- Overall width and depth measurements are with tablet positioned in center of chair
- Tablet surface is available in black only
- Tool-less assembly required

Student Chair

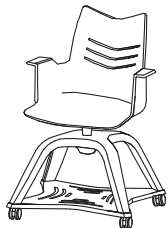

Mobile



Static

Quick Delivery Models: QN21AAC, QN21AAUC, QN21AAG, QN21AAG

		1	2/COM	3/COL	4	6	7	L7	L8
N21AAC	Mobile	\$ 510							
N21AAUC	Upholstered Seat, Mobile	627	643	651	662	697	726	864	908
N21AAG	Static	\$ 510							
N21AAG	Upholstered Seat, Static	627	643	651	662	697	726	864	908

Dimensions

Width	26	Seat Height	17¾	Arm Height	27	Weight	45
Depth	24¼	Seat Depth	17	Back Height	18¼	Upholstered Seat Model Weight	50
Height	36½	Seat Width	19½	Back Width	17	Cubic Ft.	9.5

- Tool-less assembly required

Task Chair with Tablet



Mobile



Static

Model No. Grade / List Price

Quick Delivery Models: QN21BBTC, QN21BBTUC, QN21BBTG, QN21BBTUG

		1	2/COM	3/COL	4	6	7	L7	L8
N21BBTC	Mobile	\$ 587							
N21BBTUC	Upholstered Seat, Mobile	704	720	728	739	774	803	941	985
N21BBTG	Static	\$ 587							
N21BBTUG	Upholstered Seat, Static	704	720	728	739	774	803	941	985

Dimensions

Width	26	Seat Height	16¼-20¾	Arm Height	24¼-28¾	Weight	55
Depth	33	Seat Depth	17	Back Height	18¼	Upholstered Seat Model Weight	60
Height	34¼-38¾	Seat Width	19½	Back Width	17	Cubic Ft.	17.5

- Overall width and depth measurements are with tablet positioned in center of chair
- Base is available in black only
- Tablet surface and arm support are available in black only

Task Chair



Mobile



Static

Quick Delivery Models: QN21BBC, QN21BBUC, QN21BBG, QN21BBUG

		1	2/COM	3/COL	4	6	7	L7	L8
N21BBC	Mobile	\$ 408							
N21BBUC	Upholstered Seat, Mobile	525	541	549	560	595	624	762	806
N21BBG	Static	\$ 408							
N21BBUG	Upholstered Seat, Static	525	541	549	560	595	624	762	806

Dimensions

Width	26	Seat Height	16¼-20¾	Arm Height	24¼-28¾	Weight	45
Depth	24¾	Seat Depth	17	Back Height	18¼	Upholstered Seat Model Weight	50
Height	34¼-38¾	Seat Width	19½	Back Width	17	Cubic Ft.	17.5

- Base is available in black only

To You In **10** DAYS
...or Less

Shaded model numbers are available on our "To You in 10 Days or Less" Quick Delivery program and will be delivered within 10 days.

Task Stool
To Order, Specify:

1. Model Number
2. Shell Color
3. Fabric Grade / Cover Number (when applicable)
4. Caster or Glide

• See page 141 for Essay options

Task Stool

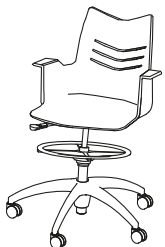

Mobile



Static

Model No. **Grade / List Price**

Quick Delivery Models: QN21CCC, QN21CCUC, QN21CCG, QN21CCUG

		1	2/COM	3/COL	4	6	7	L7	L8
N21CCC	Mobile	\$ 536							
N21CCUC	Upholstered Seat, Mobile	653	669	677	688	723	752	890	934
N21CCG	Static	\$ 536							
N21CCUG	Upholstered Seat, Static	653	669	677	688	723	752	890	934

Dimensions

Width	26	Seat Height	19½-27¼	Arm Height	27¾-35½	Weight	58
Depth	24¾	Seat Depth	17	Back Height	18¼	Upholstered Seat Model Weight	63
Height	37¼-45	Seat Width	19½	Back Width	17	Cubic Ft.	17.5

- Base is available in black only

Upholstered Seat Cushion



Quick Delivery Model: QN21UPH

		1	2/COM	3/COL	4	6	7	L7	L8
N21UPH		\$ 153	169	177	188	223	252	390	434

Dimensions

Width	17¾	Weight	8
Depth	16½	Cubic Ft.	1.2
Height	½		

- Field installable

Cup Holder



Quick Delivery Model: QN21CUP

N21CUP	Black, Package of 1	\$ 51
---------------	---------------------	--------------

Weight	5
Cubic Ft.	0.5

- Option for tablet models only
- Cup holder is available in black only
- Field installable
- Light assembly required

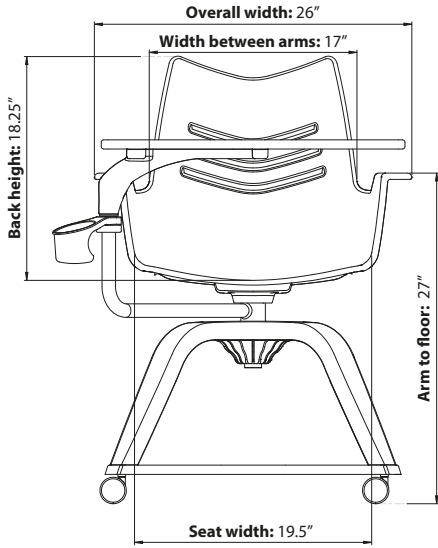

Student Chair - Front View

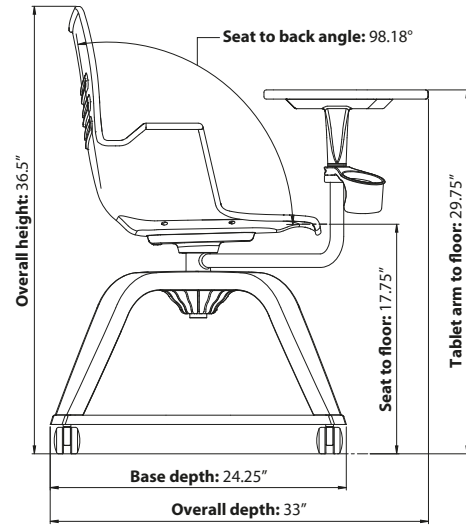

Student Chair - Side View

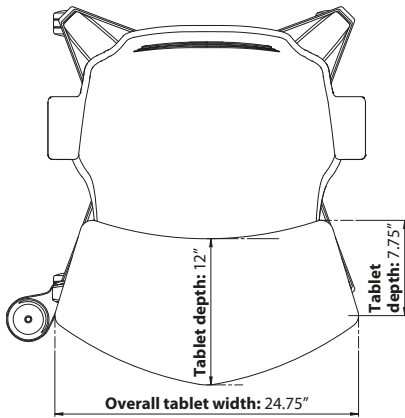

Student Chair - Top Down View

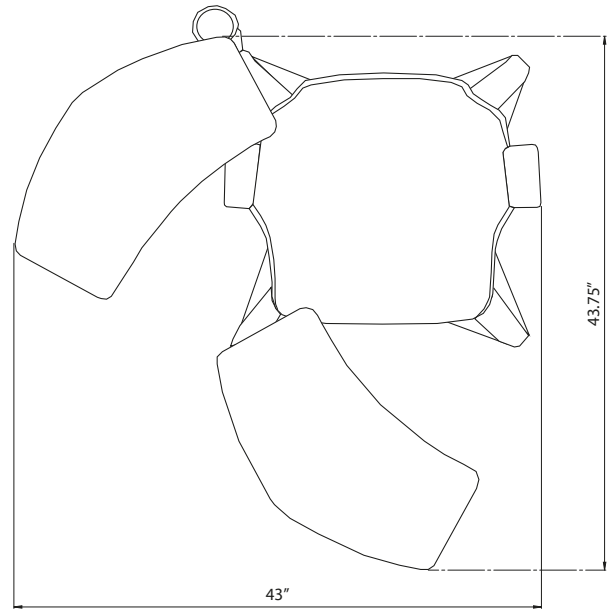

Student Chair - Tablet Swing View

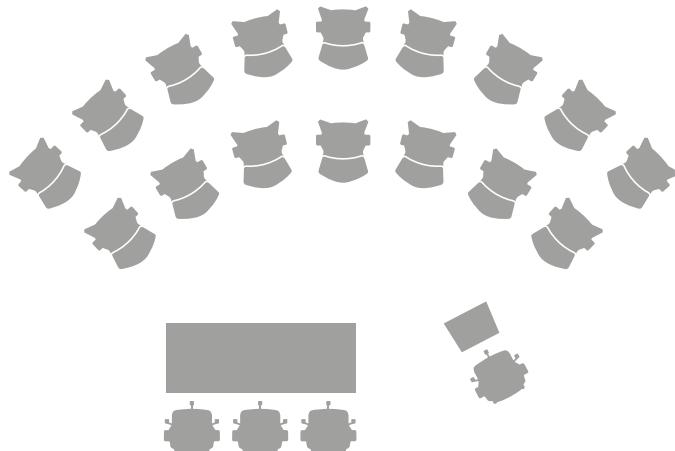
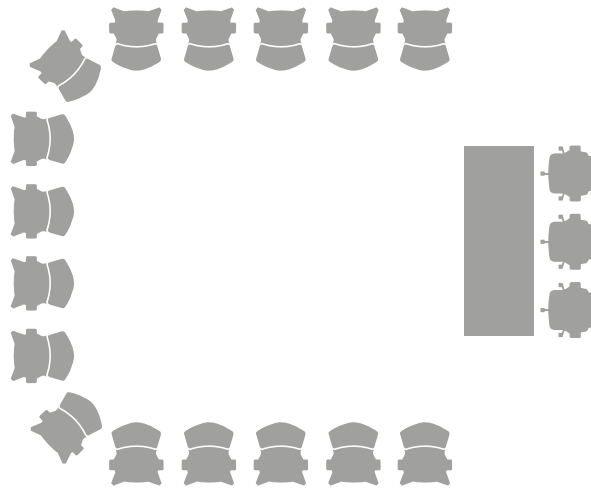
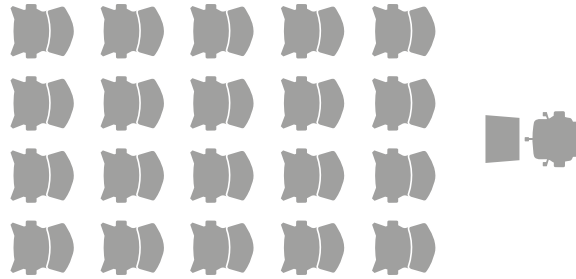

Fringe®

Fringe

FRINGE LOUNGE PRODUCT SPECIFICATIONS

92 Series

FRAME CONSTRUCTION

- Interior frame is constructed of plywood with tenon joints that are glued and screwed for maximum joint stability
- Each joint is securely glued for maximum stability

SEAT CONSTRUCTION

- Lounge chairs feature 5½" of high grade polyurethane foam covering a plywood seat panel
- Club chair features 7½" of high grade polyurethane foam covering a plywood seat panel

BACK CONSTRUCTION

- Lounge chairs feature 1½" of high grade custom shaped polyurethane foam stretched over web sheet and attached to frame
- Club chair features 2¼" of high grade custom shaped polyurethane foam stretched over web sheet and attached to frame

ARM REST

- Lounge chairs feature plywood constructed arm frame covered with ¾" high grade polyurethane foam on arm surface and ⅜" on the sides
- Club chair features plywood constructed arm frame covered with 2" high grade polyurethane foam on arm surface and ⅜" on the sides

TABLET ARMS

- ¾" thick laminate with MDF core or ¾" thick plywood with veneer surface
- Attached with ¼" steel base plate with screws that mounts over a ¾" insert rod and fits into structure of arm
- Allows for 360 degree swivel and writing surface of 21" W x 13½" D
- Tablet height is 28½" from floor to top of tablet surface

LEGS AND GLIDES

- Die-cast aluminum legs available in polished or powder coated Cinder, Platinum Metallic or Satin Nickel Metallic
- Features a black 1" adjustable leveling glide
- Soft glides are available for an additional upcharge

CLUB CHAIR BASE AND GLIDES

- Die-cast aluminum five-prong base available in polished or powder coated Cinder, Platinum Metallic or Satin Nickel Metallic
- Non-marring nylon glides

CLUB CHAIR CONTROL

- Features 360 degree swivel with auto-return, static model only

UPHOLSTERY DETAIL

- Contrasting fabric available on all models, except benches and armless club chair

POWER GROMMET

- Features two electrical receptacles and two power USB ports

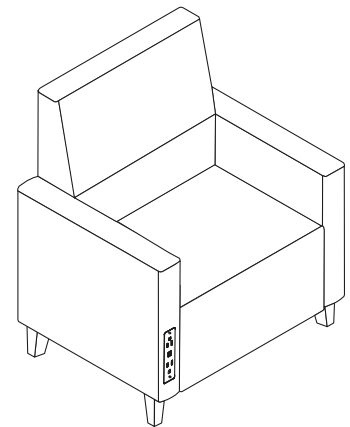
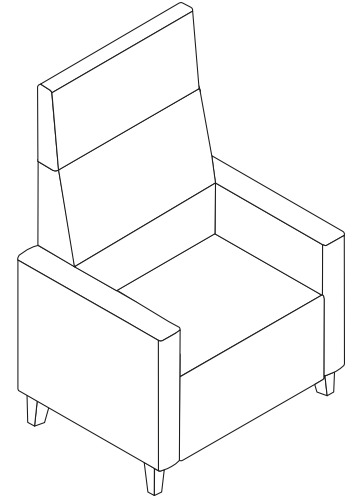

For comprehensive sustainability information that includes LEED® point contribution, visit NationalOfficeFurniture.ecoScorecard.com.

All Fringe models may be ordered to meet TB133 fire code.

To order seating to meet the TB133 fire code, specify an "F" at the end of the model number (Ex: N92M1MF).

Please consult customer service for applicable Arc-Com, COM, Maharam, Momentum, Stinson or Ultrafabrics fabric.

FABRICS

Grade 1	American Graffiti
	Cali
	Plush
	Ridge
	Speedway
	Stardust
Grade 2	Cathedral
	COM
	Orbit
	Pixie
	Sedona
	Shenanigans
	Spectrum
	Strand
	Tranquility
	Twilight

Grade 3	Boardwalk
	COL
	Jacks
	Pop Rocks
Grade 4	Big City
	Bumble
	Connect Four
	Echo
	Silvertex
Grade 6	Essence/Ultraleather
	Flock
	Scribe

Grade 7	Brisa
	Brisa Distressed
	Promessa
	Silica
Grade L7	Davenport
Grade L8	Showcase

TABLET ARM

W405	Wood, Designer White
W462	Wood, Cinder
W792	Wood, Sable
W793	Wood, Acorn
WAC	Wood, Autumn
WCL	Wood, Caramel
WCW	Wood, Cordovan
WDW	Wood, Judicial
WHN	Wood, Honey
WIM	Wood, Brighton
WMC	Wood, Amber
WMH	Wood, Mocha
WNM	Wood, Natural
WTF	Wood, Truffle
L405	Laminate, Designer White
L417	Laminate, Mojave
L418	Laminate, Mouse
L419	Laminate, Wallaby
L425	Laminate, Shadow
L440	Laminate, Cloud
L461	Laminate, Graphite
L462	Laminate, Cinder
L478	Laminate, Platinum Grey
L488	Laminate, Frosty White
L491	Laminate, Designer White Linear
L492	Laminate, Cinder Linear
L791	Laminate, Palisander
L792	Laminate, Sable
L793	Laminate, Acorn
LAC2	Laminate, Autumn 2
LCL	Laminate, Caramel
LCW	Laminate, Cordovan
LDW	Laminate, Judicial
LHN2	Laminate, Honey 2
LIM	Laminate, Brighton
LMC	Laminate, Amber
LMH	Laminate, Mocha
LNМ	Laminate, Natural
LTF	Laminate, Truffle

LAMINATES

IM	Brighton	405	Designer White
NM	Natural	417	Mojave
HN2	Honey 2	418	Mouse
CL	Caramel	419	Wallaby
TF	Truffle	425	Shadow
AC2	Autumn 2	440	Cloud
MC	Amber	461	Graphite
CW	Cordovan	462	Cinder
DW	Judicial	478	Platinum Grey
MH	Mocha	488	Frosty White
*791	Palisander	491	Designer White Linear
792	Sable	492	Cinder Linear
793	Acorn		

*791 Palisander coordinates with (NM) Natural, (HN) Honey and (MH) Mocha finishes

LEG/BASE COLORS

Metal			
462	Cinder		
497	Polished Aluminum		
501	Platinum Metallic		
503	Satin Nickel Metallic		
Wood (\$125 list upcharge per chair)			
IM	Brighton	CW	Cordovan
NM	Natural	DW	Judicial
HN	Honey	MH	Mocha
CL	Caramel	405	Designer White
TF	Truffle	462	Cinder
AC	Autumn	792	Sable
MC	Amber	793	Acorn

POWER GROMMET OPTIONS

(\$443 list upcharge per location)

G23BL	Black, Left
G23BR	Black, Right
G23BLR	Black, Left & Right
G23SL	Silver, Left
G23SR	Silver, Right
G23SLR	Silver, Left & Right
X	No Grommet

Lounge with Power Grommets

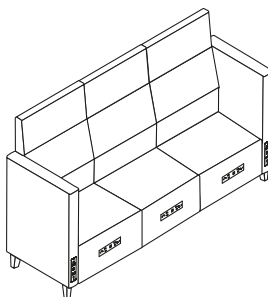

Cove with Power Grommets

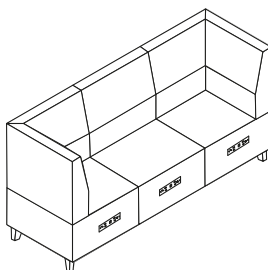

GLIDES

STD	Standard
C10	Soft (add \$26 list)

Corner with Power Grommets

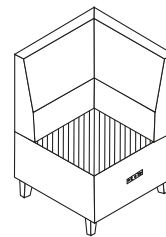

Wedges with Power Grommets

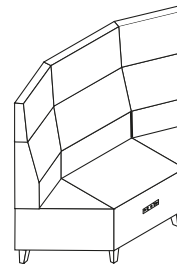

Bench with Power Grommets

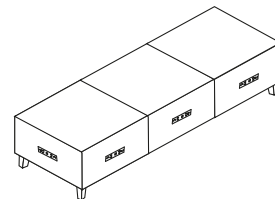

Fringe

To Order, Specify:

1. Model Number
2. Fabric Grade / Cover Number
3. Front Arm Grommet
4. Front Seat Grommet
5. Tablet and Finish (when applicable)
6. Leg Color
7. Glides

• See page 149 for Fringe options

Mid Back One Seat Lounge

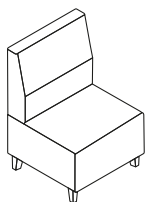

Armless

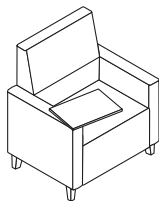

Tablet Right Arm

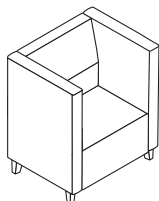

Mid Arms

Model No.

Grade / List Price

		1	2/COM	3/COL	4	6	7	L7	L8
N92M1M	Armless	\$ 1559	1653	1698	1764	1969	2137	2945	3203
N92M1B	Arms	2037	2193	2268	2377	2717	2996	4335	4764
N92M1BR	Tablet Right Arm	2275	2431	2506	2615	2955	3234	4573	5002
N92M1BL	Tablet Left Arm	2275	2431	2506	2615	2955	3234	4573	5002
N92M1BM	Mid Arms	2346	2537	2628	2761	3176	3516	5151	5674

Dimensions

Width	27	Seat Height	18½	Arm Height	27½	Weight	69
Width with Arms	35	Seat Depth	20½	Mid Arm Height	40¼	Weight with Arms	107
Depth	27	Seat Width	27	Back Height	22½	Weight with Tablet	114
Height	40¼			Back Width	27	Weight with Mid Arms	123
						Cubic Ft.	29.8
						Cubic Ft. with Tablet	32.9

- Power grommet only available on arm models (factory installed); specify grommet option (add \$443 list per grommet)
- Contrasting fabric option – specify X (i.e., N92M1MX); see next page. For list pricing, use your electronic specification tool or contact customer service
- Soft glide option available for a \$26 list upcharge

**Mid Back
One Seat Lounge
Single Arm**

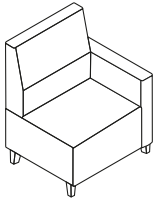

Left Arm

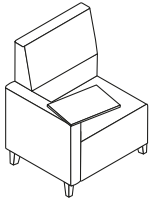

Tablet Right Arm

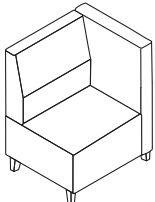

Left Mid Arm

**Model
No.**

Grade / List Price

		1	2/COM	3/COL	4	6	7	L7	L8
N92M1R	Right Arm	\$ 1798	1925	1985	2073	2348	2574	3657	4004
N92M1RR	Tablet Right Arm	2037	2164	2224	2312	2587	2813	3896	4243
N92M1RM	Right Mid Arm	1953	2096	2164	2263	2573	2827	4049	4439
N92M1L	Left Arm	1798	1925	1985	2073	2348	2574	3657	4004
N92M1LL	Tablet Left Arm	2037	2164	2224	2312	2587	2813	3896	4243
N92M1LM	Left Mid Arm	1953	2096	2164	2263	2573	2827	4049	4439

Dimensions

Width	31	Seat Height	18½	Arm Height	27½	Weight	88
Depth	27	Seat Depth	20½	Mid Arm Height	40¼	Weight with Tablet	95
Height	40¼	Seat Width	27	Back Height	22½	Weight with Mid Arm	96
				Back Width	27	Cubic Ft.	29.8
						Cubic Ft. with Tablet	32.9

- Power grommet only available on arm models (factory installed); specify grommet option (add \$443 list per grommet)
- Contrasting fabric option – specify X (i.e., N92M1RX); see below. For list pricing, use your electronic specification tool or contact customer service
- Soft glide option available for a \$26 list upcharge

To Order Contrasting Fabric, Specify:

1. Model Number plus "X"
2. Back Fabric Grade Number/Cover Number
3. Lumbar Fabric Grade Number/Cover Number
4. Seat Fabric Grade Number/Cover Number
5. Arm Fabric Grade Number/Cover Number (when applicable)
6. Front Arm Grommet
7. Front Seat Grommet
8. Tablet and Finish (when applicable)
9. Leg Color
10. Glides

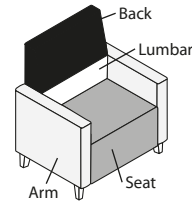

Contrasting Upholstery

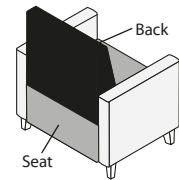

Contrasting Upholstery Back View

Fringe

To Order, Specify:

1. Model Number
2. Fabric Grade / Cover Number
3. Front Arm Grommet
4. Front Seat Grommet
5. Tablet and Finish (when applicable)
6. Leg Color
7. Glides

• See page 149 for Fringe options

High Back One Seat Lounge

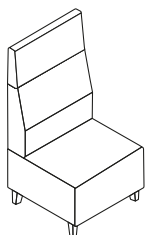

Armless

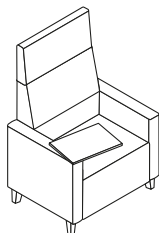

Tablet Right Arm

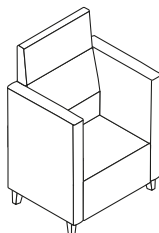

Mid Arms

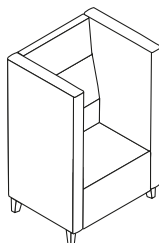

High Arms

Model No.

Grade / List Price

		1	2/COM	3/COL	4	6	7	L7	L8
N92H1M	Armless	\$ 2090	2205	2260	2340	2590	2795	3780	4095
N92H1B	Arms	2568	2745	2830	2953	3338	3654	5171	5656
N92H1BR	Tablet Right Arm	2806	2983	3068	3191	3576	3892	5409	5894
N92H1BL	Tablet Left Arm	2806	2983	3068	3191	3576	3892	5409	5894
N92H1BM	Mid Arms	2877	3089	3190	3337	3797	4174	5987	6566
N92H1BH	High Arms	2928	3172	3288	3458	3988	4423	6511	7179

Dimensions

Width	27	Seat Height	18½	Arm Height	27½	Weight	83
Width with Arms	35	Seat Depth	20½	Mid Arm Height	40¼	Weight with Arms	121
Depth	27	Seat Width	27	High Arm Height	53¼	Weight with Tablet	128
Height	53¼			Back Height	35¼	Weight with Mid Arms	137
				Back Width	27	Weight with High Arms	153
						Cubic Ft.	37.9
						Cubic Ft. with Tablet	41.9

- Power grommet only available on arm models (factory installed); specify grommet option (add \$443 list per grommet)
- Contrasting fabric option – specify X (i.e., N92H1MX); see next page. For list pricing, use your electronic specification tool or contact customer service
- Soft glide option available for a \$26 list upcharge

**High Back
One Seat Lounge
Single Arm**

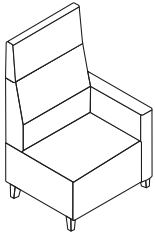

Left Arm

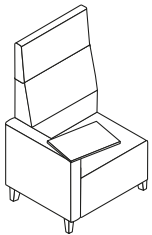

Tablet Right Arm

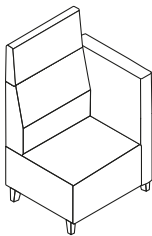

Left Mid Arm

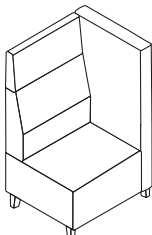

Left High Arm

**Model
No.**

Grade / List Price

		1	2/COM	3/COL	4	6	7	L7	L8
N92H1R	Right Arm	\$ 2329	2474	2543	2644	2959	3217	4458	4855
N92H1RR	Tablet Right Arm	2568	2713	2782	2883	3198	3456	4697	5094
N92H1RM	Right Mid Arm	2483	2646	2724	2838	3193	3484	4883	5330
N92H1RH	Right High Arm	2509	2688	2774	2899	3289	3609	5145	5637
N92H1L	Left Arm	2329	2474	2543	2644	2959	3217	4458	4855
N92H1LL	Tablet Left Arm	2568	2713	2782	2883	3198	3456	4697	5094
N92H1LM	Left Mid Arm	2483	2646	2724	2838	3193	3484	4883	5330
N92H1LH	Left High Arm	2509	2688	2774	2899	3289	3609	5145	5637

Dimensions

Width	31	Seat Height	18½	Arm Height	27½	Weight	102
Depth	27	Seat Depth	20½	Mid Arm Height	40¼	Weight with Tablet	109
Height	53¼	Seat Width	27	High Arm Height	53¼	Weight with Mid Arm	110
				Back Height	35¼	Weight with High Arm	118
				Back Width	27	Cubic Ft.	37.9
						Cubic Ft. with Tablet	41.9

- Power grommet only available on arm models (factory installed); specify grommet option (add \$443 list per grommet)
- Contrasting fabric option – specify X (i.e., N92H1RX); see below. For list pricing, use your electronic specification tool or contact customer service
- Soft glide option available for a \$26 list upcharge

To Order Contrasting Fabric, Specify:

1. Model Number plus "X"
2. Back Fabric Grade Number/Cover Number
3. Lumbar Fabric Grade Number/Cover Number
4. Seat Fabric Grade Number/Cover Number
5. Arm Fabric Grade Number/Cover Number (when applicable)
6. Accent (headrest) Fabric Grade Number/Cover Number
7. Front Arm Grommet
8. Front Seat Grommet
9. Tablet and Finish (when applicable)
10. Leg Color
11. Glides

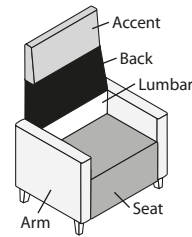

Contrasting Upholstery

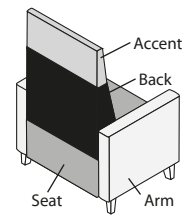

Contrasting Upholstery Back View

Fringe

To Order, Specify:

1. Model Number
2. Fabric Grade / Cover Number
3. Front Arm Grommet
4. Front Seat Grommet
5. Tablet and Finish (when applicable)
6. Leg Color
7. Glides

• See page 149 for Fringe options

Mid Back Two Seat Lounge

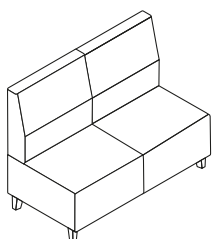

Armless

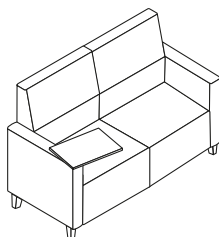

Tablet Right Arm

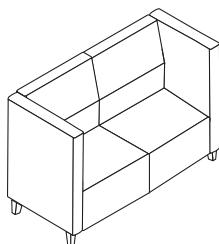

Mid Arms

Model No.

Grade / List Price

		1	2/COM	3/COL	4	6	7	L7	L8
N92M2M	Armless	\$ 2275	2438	2516	2630	2985	3276	4675	5122
N92M2B	Arms	2753	2978	3086	3243	3733	4135	6065	6683
N92M2BR	Tablet Right Arm	2992	3217	3325	3482	3972	4374	6304	6922
N92M2BL	Tablet Left Arm	2992	3217	3325	3482	3972	4374	6304	6922
N92M2BB	Tablet Both Arms	3230	3455	3563	3720	4210	4612	6542	7160
N92M2BM	Mid Arms	3062	3322	3446	3627	4192	4655	6881	7593

Dimensions

Width	53½	Seat Height	18½	Arm Height	27½	Weight	122
Width with Arms	61½	Seat Depth	20½	Mid Arm Height	40¼	Weight with Arms	160
Depth	27	Seat Width	53½	Back Height	22½	Weight with Tablet	168
Height	40¼			Back Width	53½	Weight with Two Tablets	173
						Weight with Mid Arms	176
						Cubic Ft.	51.0
						Cubic Ft. with Tablet	56.9

- Power grommet only available on arm models (factory installed); specify grommet option (add \$443 list per grommet)
- Contrasting fabric option – specify X (i.e., N92M2MX); see next page. For list pricing, use your electronic specification tool or contact customer service
- Soft glide option available for a \$26 list upcharge

**Mid Back
Two Seat Lounge
Single Arm**

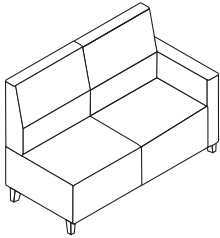

Left Arm

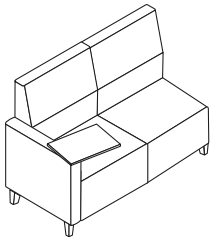

Tablet Right Arm

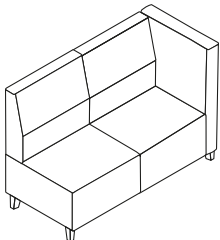

Left Mid Arm

**Model
No.**

Grade / List Price

		1	2/COM	3/COL	4	6	7	L7	L8
N92M2R	Right Arm	\$ 2514	2707	2800	2934	3354	3698	5353	5882
N92M2RR	Tablet Right Arm	2753	2946	3039	3173	3593	3937	5592	6121
N92M2RM	Right Mid Arm	2669	2881	2982	3129	3589	3966	5779	6358
N92M2L	Left Arm	2514	2707	2800	2934	3354	3698	5353	5882
N92M2LL	Tablet Left Arm	2753	2946	3039	3173	3593	3937	5592	6121
N92M2LM	Left Mid Arm	2669	2881	2982	3129	3589	3966	5779	6358

Dimensions

Width	57½	Seat Height	18½	Arm Height	27½	Weight	141
Depth	27	Seat Depth	20½	Mid Arm Height	40¼	Weight with Tablet	149
Height	40¼	Seat Width	53½	Back Height	22½	Weight with Mid Arm	149
				Back Width	53½	Cubic Ft.	51.0
						Cubic Ft. with Tablet	56.9

- Power grommet only available on arm models (factory installed); specify grommet option (add \$443 list per grommet)
- Contrasting fabric option – specify X (i.e., N92M2RX); see below. For list pricing, use your electronic specification tool or contact customer service
- Soft glide option available for a \$26 list upcharge

To Order Contrasting Fabric, Specify:

1. Model Number plus "X"
2. Back Fabric Grade Number/Cover Number
3. Lumbar Fabric Grade Number/Cover Number
4. Seat Fabric Grade Number/Cover Number
5. Arm Fabric Grade Number/Cover Number (when applicable)
6. Front Arm Grommet
7. Front Seat Grommet
8. Tablet and Finish (when applicable)
9. Leg Color
10. Glides

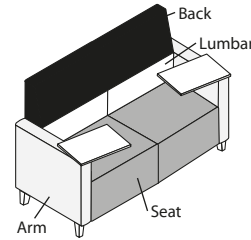

Contrasting Upholstery

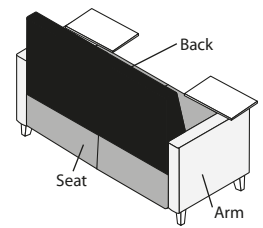

Contrasting Upholstery Back View

Fringe

To Order, Specify:

1. Model Number
2. Fabric Grade / Cover Number
3. Front Arm Grommet
4. Front Seat Grommet
5. Tablet and Finish (when applicable)
6. Leg Color
7. Glides

• See page 149 for Fringe options

High Back Two Seat Lounge

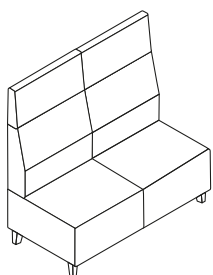

Armless

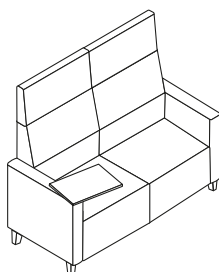

Tablet Right Arm

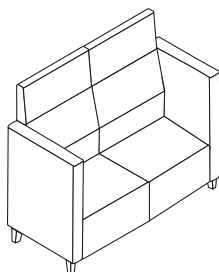

Mid Arms

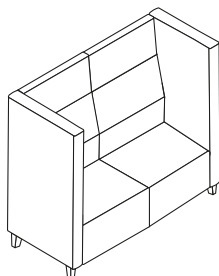

High Arms

Model No.

Grade / List Price

		1	2/COM	3/COL	4	6	7	L7	L8
N92H2M	Armless	\$ 3336	3541	3639	3781	4226	4591	6344	6905
N92H2B	Arms	3814	4079	4205	4389	4964	5436	7701	8426
N92H2BR	Tablet Right Arm	4053	4318	4444	4628	5203	5675	7940	8665
N92H2BL	Tablet Left Arm	4053	4318	4444	4628	5203	5675	7940	8665
N92H2BB	Tablet Both Arms	4291	4556	4682	4866	5441	5913	8178	8903
N92H2BM	Mid Arms	4123	4424	4568	4778	5433	5970	8551	9376
N92H2BH	High Arms	4175	4509	4668	4900	5625	6220	9076	9990

Dimensions

Width	53½	Seat Height	18½	Arm Height	27½	Weight	149
Width with Arms	61½	Seat Depth	20½	Mid Arm Height	40¼	Weight with Arms	187
Depth	27	Seat Width	53½	High Arm Height	53¼	Weight with Tablet	195
Height	53¼			Back Height	35¼	Weight with Two Tablets	200
				Back Width	53½	Weight with Mid Arms	203
						Weight with High Arms	219
						Cubic Ft.	64.9
						Cubic Ft. with Tablet	72.4

- Power grommet only available on arm models (factory installed); specify grommet option (add \$443 list per grommet)
- Contrasting fabric option – specify X (i.e., N92H2MX); see next page. For list pricing, use your electronic specification tool or contact customer service
- Soft glide option available for a \$26 list upcharge

**High Back
Two Seat Lounge
Single Arm**

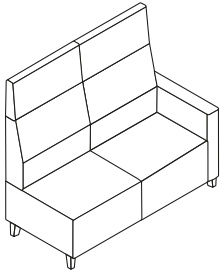

Left Arm

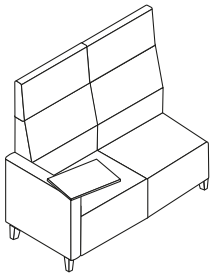

Tablet Right Arm

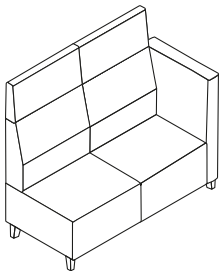

Left Mid Arm

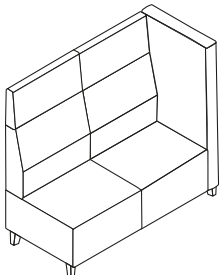

Left High Arm

**Model
No.**

Grade / List Price

		1	2/COM	3/COL	4	6	7	L7	L8
N92H2R	Right Arm	\$ 3575	3810	3922	4085	4595	5013	7023	7665
N92H2RR	Tablet Right Arm	3814	4049	4161	4324	4834	5252	7262	7904
N92H2RM	Right Mid Arm	3730	3983	4104	4280	4830	5281	7448	8141
N92H2RH	Right High Arm	3755	4024	4153	4340	4925	5405	7710	8447
N92H2L	Left Arm	3575	3810	3922	4085	4595	5013	7023	7665
N92H2LL	Tablet Left Arm	3814	4049	4161	4324	4834	5252	7262	7904
N92H2LM	Left Mid Arm	3730	3983	4104	4280	4830	5281	7448	8141
N92H2LH	Left High Arm	3755	4024	4153	4340	4925	5405	7710	8447

Dimensions

Width	57½	Seat Height	18½	Arm Height	27½	Weight	168
Depth	27	Seat Depth	20½	Mid Arm Height	40¼	Weight with Tablet	176
Height	53¼	Seat Width	53½	High Arm Height	53¼	Weight with Mid Arm	176
				Back Height	35¼	Weight with High Arm	184
				Back Width	53½	Cubic Ft.	64.9
						Cubic Ft. with Tablet	72.4

- Power grommet only available on arm models (factory installed); specify grommet option (add \$443 list per grommet)
- Contrasting fabric option – specify X (i.e., N92H2RX); see below. For list pricing, use your electronic specification tool or contact customer service
- Soft glide option available for a \$26 list upcharge

To Order Contrasting Fabric, Specify:

1. Model Number plus "X"
2. Back Fabric Grade Number/Cover Number
3. Lumbar Fabric Grade Number/Cover Number
4. Seat Fabric Grade Number/Cover Number
5. Arm Fabric Grade Number/Cover Number (when applicable)
6. Accent (headrest) Fabric Grade Number/Cover Number
7. Front Arm Grommet
8. Front Seat Grommet
9. Tablet and Finish (when applicable)
10. Leg Color
11. Glides

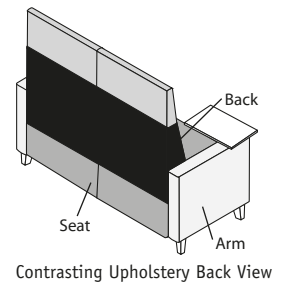
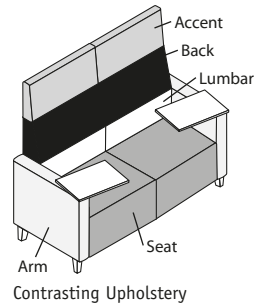

Fringe

To Order, Specify:

1. Model Number
2. Fabric Grade / Cover Number
3. Front Arm Grommet
4. Front Seat Grommet
5. Tablet and Finish (when applicable)
6. Leg Color
7. Glides

• See page 149 for Fringe options

Mid Back Three Seat Lounge

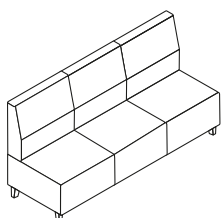

Armless

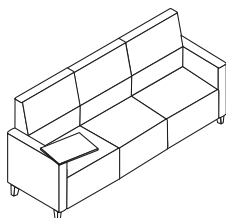

Tablet Right Arm

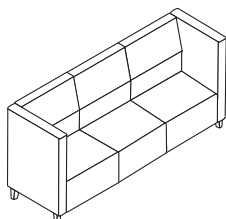

Mid Arms

Model No.

Grade / List Price

		1	2/COM	3/COL	4	6	7	L7	L8
N92M3M	Armless	\$ 2992	3224	3335	3497	4002	4416	6406	7042
N92M3B	Arms	3469	3763	3904	4109	4749	5274	7795	8602
N92M3BR	Tablet Right Arm	3708	4002	4143	4348	4988	5513	8034	8841
N92M3BL	Tablet Left Arm	3708	4002	4143	4348	4988	5513	8034	8841
N92M3BB	Tablet Both Arms	3947	4241	4382	4587	5227	5752	8273	9080
N92M3BM	Mid Arms	3778	4107	4264	4493	5208	5794	8611	9512

Dimensions

Width	79¾	Seat Height	18½	Arm Height	27½	Weight	163
Width with Arms	87¾	Seat Depth	20½	Mid Arm Height	40¼	Weight with Arms	201
Depth	27	Seat Width	79¾	Back Height	22½	Weight with Tablet	209
Height	40¼			Back Width	79¾	Weight with Two Tablets	214
						Weight with Mid Arms	217
						Cubic Ft.	72.4
						Cubic Ft. with Tablet	79.2

- Power grommet only available on arm models (factory installed); specify grommet option (add \$443 list per grommet)
- Contrasting fabric option – specify X (i.e., N92M3MX); see next page. For list pricing, use your electronic specification tool or contact customer service
- Soft glide option available for a \$26 list upcharge

**Mid Back
Three Seat Lounge
Single Arm**

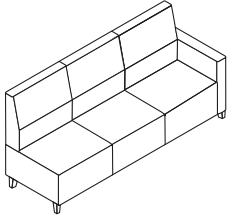

Left Arm

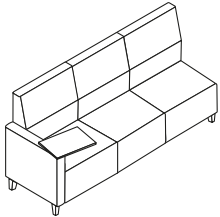

Tablet Right Arm

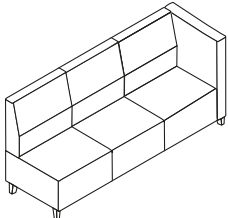

Left Mid Arm

**Model
No.**

Grade / List Price

		1	2/COM	3/COL	4	6	7	L7	L8
N92M3R	Right Arm	\$ 3230	3495	3621	3805	4380	4852	7117	7842
N92M3RR	Tablet Right Arm	3469	3734	3860	4044	4619	5091	7356	8081
N92M3RM	Right Mid Arm	3385	3666	3800	3995	4605	5105	7509	8277
N92M3L	Left Arm	3230	3495	3621	3805	4380	4852	7117	7842
N92M3LL	Tablet Left Arm	3469	3734	3860	4044	4619	5091	7356	8081
N92M3LM	Left Mid Arm	3385	3666	3800	3995	4605	5105	7509	8277

Dimensions

Width	83¾	Seat Height	18½	Arm Height	27½	Weight	182
Depth	27	Seat Depth	20½	Mid Arm Height	40¼	Weight with Tablet	190
Height	40¼	Seat Width	79¾	Back Height	22½	Weight with Mid Arm	190
				Back Width	79¾	Cubic Ft.	72.2
						Cubic Ft. with Tablet	79.2

- Power grommet only available on arm models (factory installed); specify grommet option (add \$443 list per grommet)
- Contrasting fabric option – specify X (i.e., N92M3RX); see below. For list pricing, use your electronic specification tool or contact customer service
- Soft glide option available for a \$26 list upcharge

To Order Contrasting Fabric, Specify:

1. Model Number plus "X"
2. Back Fabric Grade Number/Cover Number
3. Lumbar Fabric Grade Number/Cover Number
4. Seat Fabric Grade Number/Cover Number
5. Arm Fabric Grade Number/Cover Number (when applicable)
6. Front Arm Grommet
7. Front Seat Grommet
8. Tablet and Finish (when applicable)
9. Leg Color
10. Glides

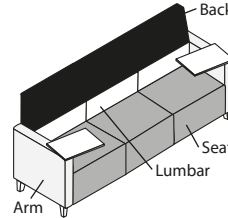

Contrasting Upholstery

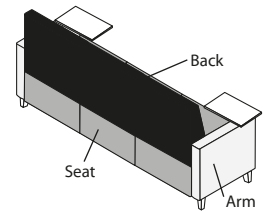

Contrasting Upholstery Back View

Fringe

To Order, Specify:

1. Model Number
2. Fabric Grade / Cover Number
3. Front Arm Grommet
4. Front Seat Grommet
5. Tablet and Finish (when applicable)
6. Leg Color
7. Glides

• See page 149 for Fringe options

High Back Three Seat Lounge

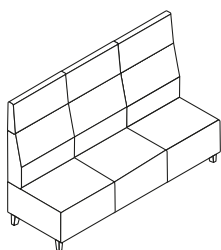

Armless

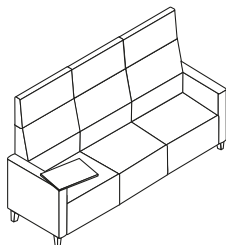

Tablet Right Arm

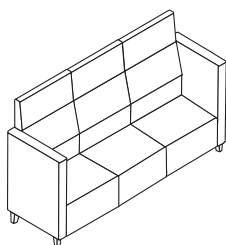

Mid Arms

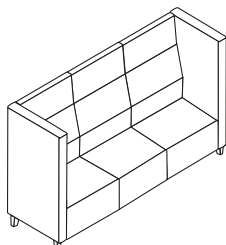

High Arms

Model No.

Grade / List Price

		1	2/COM	3/COL	4	6	7	L7	L8
N92H3M	Armless	\$ 4584	4876	5016	5219	5854	6375	8877	9677
N92H3B	Arms	5060	5414	5584	5830	6600	7231	10265	11235
N92H3BR	Tablet Right Arm	5299	5653	5823	6069	6839	7470	10504	11474
N92H3BL	Tablet Left Arm	5299	5653	5823	6069	6839	7470	10504	11474
N92H3BB	Tablet Both Arms	5538	5892	6062	6308	7078	7709	10743	11713
N92H3BM	Mid Arms	5369	5760	5947	6219	7069	7766	11115	12186
N92H3BH	High Arms	5421	5844	6047	6341	7261	8015	11640	12799

Dimensions

Width	79¾	Seat Height	18½	Arm Height	27½	Weight	204
Width with Arms	87¾	Seat Depth	20½	Mid Arm Height	40¼	Weight with Arms	242
Depth	27	Seat Width	79¾	High Arm Height	53¼	Weight with Tablet	250
Height	53¼			Back Height	35¼	Weight with Two Tablets	255
				Back Width	79¾	Weight with Mid Arms	258
						Weight with High Arms	274
						Cubic Ft.	91.9
						Cubic Ft. with Tablet	100.7

- Power grommet only available on arm models (factory installed); specify grommet option (add \$443 list per grommet)
- Contrasting fabric option – specify X (i.e., N92H3MX); see next page. For list pricing, use your electronic specification tool or contact customer service
- Soft glide option available for a \$26 list upcharge

**High Back
Three Seat Lounge
Single Arm**

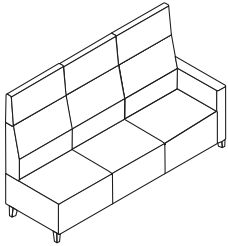

Left Arm

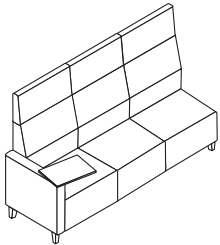

Tablet Right Arm

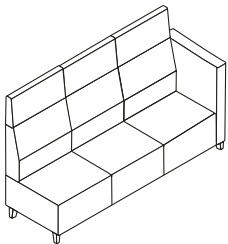

Left Mid Arm

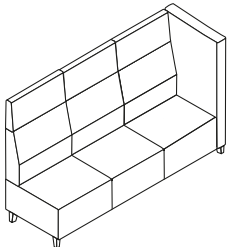

Left High Arm

**Model
No.**

Grade / List Price

		1	2/COM	3/COL	4	6	7	L7	L8
N92H3R	Right Arm	\$ 4821	5145	5300	5526	6231	6809	9587	10475
N92H3RR	Tablet Right Arm	5060	5384	5539	5765	6470	7048	9826	10714
N92H3RM	Right Mid Arm	4976	5319	5483	5721	6466	7077	10012	10951
N92H3RH	Right High Arm	5002	5361	5532	5782	6562	7202	10275	11258
N92H3L	Left Arm	4821	5145	5300	5526	6231	6809	9587	10475
N92H3LL	Tablet Left Arm	5060	5384	5539	5765	6470	7048	9826	10714
N92H3LM	Left Mid Arm	4976	5319	5483	5721	6466	7077	10012	10951
N92H3LH	Left High Arm	5002	5361	5532	5782	6562	7202	10275	11258

Dimensions

Width	83¾	Seat Height	18½	Arm Height	27½	Weight	223
Depth	27	Seat Depth	20½	Mid Arm Height	40¼	Weight with Tablet	231
Height	53¼	Seat Width	79¾	High Arm Height	53¼	Weight with Mid Arm	231
				Back Height	35¼	Weight with High Arm	239
				Back Width	79¾	Cubic Ft.	91.9
						Cubic Ft. with Tablet	100.7

- Power grommet only available on arm models (factory installed); specify grommet option (add \$443 list per gromme)
- Contrasting fabric option – specify X (i.e., N92H3RX); see below. For list pricing, use your electronic specification tool or contact customer service
- Soft glide option available for a \$26 list upcharge

To Order Contrasting Fabric, Specify:

1. Model Number plus "X"
2. Back Fabric Grade Number/Cover Number
3. Lumbar Fabric Grade Number/Cover Number
4. Seat Fabric Grade Number/Cover Number
5. Arm Fabric Grade Number/Cover Number (when applicable)
6. Accent (headrest) Fabric Grade Number/Cover Number (when applicable)
7. Front Arm Grommet
8. Front Seat Grommet
9. Tablet and Finish (when applicable)
10. Leg Color
11. Glides

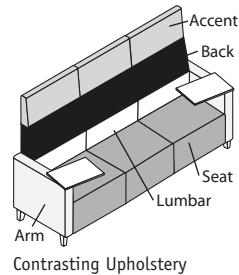

Contrasting Upholstery

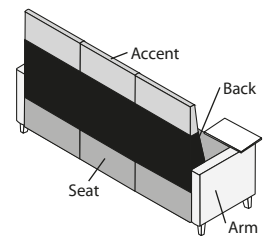

Contrasting Upholstery Back View

Fringe

To Order, Specify:

1. Model Number
2. Fabric Grade / Cover Number
3. Front Seat Grommet
4. Leg Color
5. Glides

• See page 149 for Fringe options

Mid Back Two Seat Cove Lounge

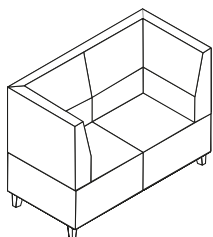

Model No.	Grade / List Price								
		1	2/COM	3/COL	4	6	7	L7	L8
N92MC2	Upholstered Back	\$ 3870	4022	4094	4200	4530	4801	6101	6517

Dimensions

Width	53¾	Seat Height	18½	Back Height	22½	Weight	184
Depth	27	Seat Depth	20½	Back Width	53½	Cubic Ft.	51.0
Height	40¼	Seat Width	53½				

- Specify grommet option (add \$443 list per grommet); left, right or both
- Contrasting fabric option – specify X (i.e., N92MC2X); see next page. For list pricing, use your electronic specification tool or contact customer service
- Soft glide option available for a \$26 list upcharge

High Back Two Seat Cove Lounge

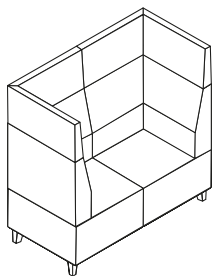

Model No.	Grade / List Price								
		1	2/COM	3/COL	4	6	7	L7	L8
N92HC2	Upholstered Back	\$ 5382	5594	5695	5842	6302	6679	8492	9071

Dimensions

Width	53¾	Seat Height	18½	Back Height	35¼	Weight	238
Depth	27	Seat Depth	20½	Back Width	53½	Cubic Ft.	64.9
Height	53¼	Seat Width	53½				

- Specify grommet option (add \$443 list per grommet); left, right or both
- Contrasting fabric option – specify X (i.e., N92HC2X); see next page. For list pricing, use your electronic specification tool or contact customer service
- Soft glide option available for a \$26 list upcharge

**Mid Back
Three Seat Cove Lounge**

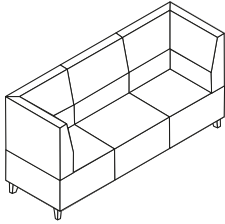

**Model
No.**

Grade / List Price

		1	2/COM	3/COL	4	6	7	L7	L8
N92MC3	Upholstered Back	\$ 5352	5621	5750	5937	6522	7002	9307	10044

Dimensions

Width	80¼	Seat Height	18½	Back Height	22½	Weight	253
Depth	27	Seat Depth	20½	Back Width	79¾	Cubic Ft.	72.4
Height	40¼	Seat Width	79¾				

- Specify grommet option (add \$443 list per grommet); left, center, right, combination or all
- Contrasting fabric option – specify X (i.e., N92MC3X); see below. For list pricing, use your electronic specification tool or contact customer service
- Soft glide option available for a \$26 list upcharge

**High Back
Three Seat Cove Lounge**

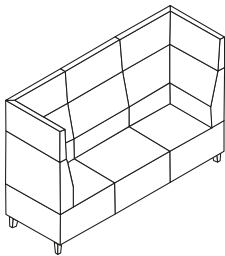

		1	2/COM	3/COL	4	6	7	L7	L8
N92HC3	Upholstered Back	\$ 7368	7736	7912	8168	8968	9624	12776	13784

Dimensions

Width	80¼	Seat Height	18½	Back Height	35¼	Weight	321
Depth	27	Seat Depth	20½	Back Width	79¾	Cubic Ft.	91.9
Height	53¼	Seat Width	79¾				

- Specify grommet option (add \$443 list per grommet); left, center, right, combination or all
- Contrasting fabric option – specify X (i.e., N92HC3X); see below. For list pricing, use your electronic specification tool or contact customer service
- Soft glide option available for a \$26 list upcharge

To Order Contrasting Fabric, Specify:

1. Model Number plus "X"
2. Back Fabric Grade Number/Cover Number
3. Lumbar Fabric Grade Number/Cover Number
4. Seat Fabric Grade Number/Cover Number
5. Accent (headrest) Fabric Grade Number/Cover Number (when applicable)
6. Front Seat Grommet
7. Leg Color
8. Glides

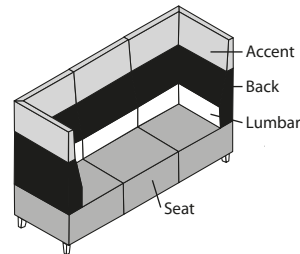

Contrasting Upholstery

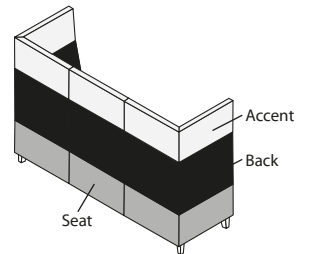

Contrasting Upholstery Back View

Fringe

To Order, Specify:

1. Model Number
2. Fabric Grade / Cover Number
3. Front Seat Grommet
4. Leg Color
5. Glides

• See page 149 for Fringe options

Mid Back Square 90° Corner

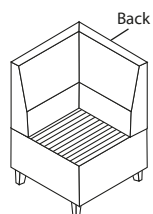

Right

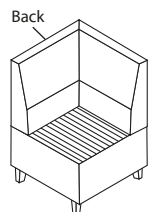

Left

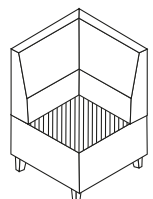

Diagonal
(Vertical Stripe Depicted)

Shown with Grommet Location Options

Model No.	Grade / List Price	Grade / List Price							
		1	2/COM	3/COL	4	6	7	L7	L8
N92MSQ9R	Square 90°, Right	\$ 2037	2124	2166	2227	2417	2573	3321	3561
N92MSQ9L	Square 90°, Left	2037	2124	2166	2227	2417	2573	3321	3561
N92MSQ9D	Square 90°, Diagonal	2037	2136	2183	2252	2467	2643	3490	3761

Dimensions

Width	27	Seat Height	18½	Back Height	22½	Weight	92
Depth	27	Seat Depth	20½	Back Width	20½	Cubic Ft.	29.8
Height	40¼	Seat Width	20½				

- Contrasting fabric option – specify X (i.e., N92MSQ9RX); see next page. For list pricing, use your electronic specification tool or contact customer service
- Diagonal model is recommended for directional fabrics
- Soft glide option available for a \$26 list upcharge

High Back Square 90° Corner

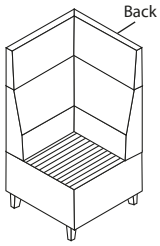

Right

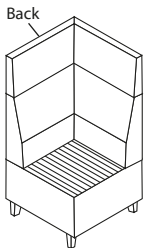

Left

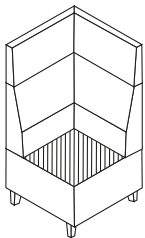

Diagonal
(Vertical Stripe Depicted)

Shown with Grommet Location Options

Model No.

Grade / List Price

		1	2/COM	3/COL	4	6	7	L7	L8
N92HSQ9R	Square 90°, Right	\$ 2833	2950	3006	3088	3343	3552	4557	4878
N92HSQ9L	Square 90°, Left	2833	2950	3006	3088	3343	3552	4557	4878
N92HSQ9D	Square 90°, Diagonal	2833	2960	3020	3108	3383	3609	4692	5039

Dimensions

Width	27	Seat Height	18½	Back Height	22½	Weight	119
Depth	27	Seat Depth	20½	Back Width	20½	Cubic Ft.	37.9
Height	53¼	Seat Width	20½				

- Contrasting fabric option – specify X (i.e., N92HSQ9RX); see below. For list pricing, use your electronic specification tool or contact customer service
- Diagonal model is recommended for directional fabrics
- Soft glide option available for a \$26 list upcharge

To Order Contrasting Fabric, Specify:

1. Model Number plus "X"
2. Back Fabric Grade Number/Cover Number
3. Lumbar Fabric Grade Number/Cover Number
4. Seat Fabric Grade Number/Cover Number
5. Front Seat Grommet
6. Accent (headrest) Fabric Grade Number/Cover Number (when applicable)
7. Leg Color
8. Glides

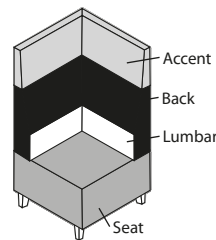

Contrasting Upholstery

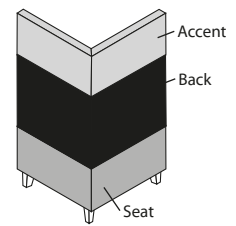

Contrasting Upholstery Back View

Fabric Application Diagrams (Vertical Stripe Depicted)

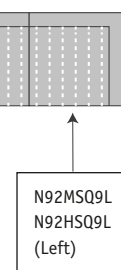
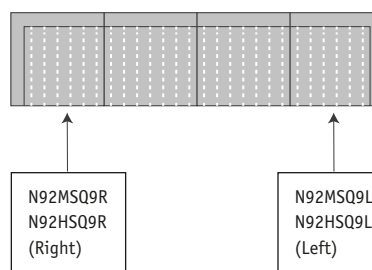
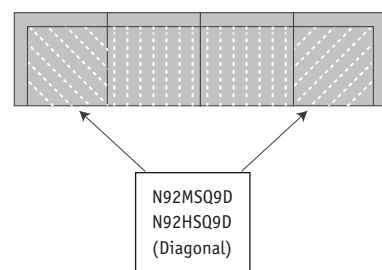
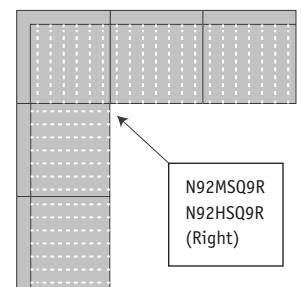
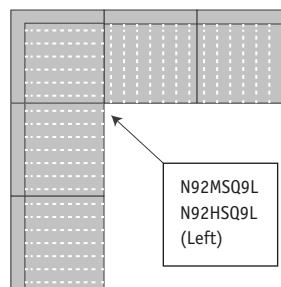
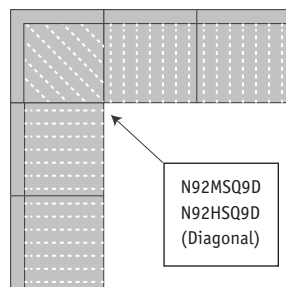

Fringe

To Order, Specify:

1. Model Number
 2. Fabric Grade / Cover Number
 3. Front Seat Grommet
 4. Leg Color
 5. Glides
- See page 149 for Fringe options

Mid Back Outside 90° Wedge

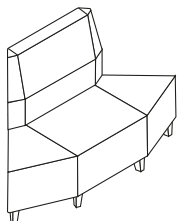

Model No.	Grade / List Price	Grade / List Price							
		1	2/COM	3/COL	4	6	7	L7	L8
N92MOU9	Outside 90°	\$ 2275	2372	2418	2485	2695	2867	3695	3959

Dimensions

Width	63½	Seat Height	18½	Back Height	22½	Weight	112
Depth	27	Seat Depth	20½	Back Width	34½	Cubic Ft.	53.8
Height	40¼	Seat Width	63½				

- Contrasting fabric option – specify X (i.e., N92MOU9X); see below. For list pricing, use your electronic specification tool or contact customer service
- Soft glide option available for a \$26 list upcharge

Mid Back Inside 90° Wedge

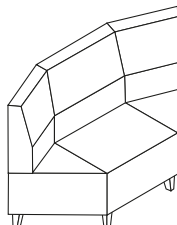

Model No.	Grade / List Price	Grade / List Price							
		1	2/COM	3/COL	4	6	7	L7	L8
N92MIN9	Inside 90°	\$ 2275	2392	2448	2530	2785	2994	3999	4320

Dimensions

Width	63½	Seat Height	18½	Back Height	22½	Weight	137
Depth	27	Seat Depth	20½	Back Width	60	Cubic Ft.	53.8
Height	40¼	Seat Width	55				

- Contrasting fabric option – specify X (i.e., N92MIN9X); see below. For list pricing, use your electronic specification tool or contact customer service
- Soft glide option available for a \$26 list upcharge

To Order Contrasting Fabric, Specify:

1. Model Number plus “X”
2. Back Fabric Grade Number/Cover Number
3. Lumbar Fabric Grade Number/Cover Number
4. Seat Fabric Grade Number/Cover Number
5. Front Seat Grommet
6. Leg Color
7. Glides

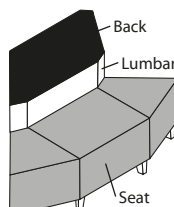

Contrasting Upholstery

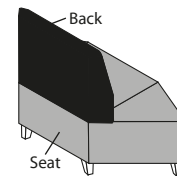

Contrasting Upholstery Back View

**High Back
Outside 90°
Wedge**

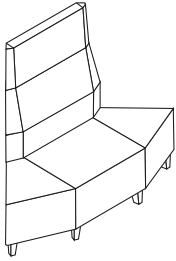

Model No.	Grade / List Price	Grade / List Price							
		1	2/COM	3/COL	4	6	7	L7	L8
N92HOU9	Outside 90°	\$ 3071	3186	3241	3321	3571	3776	4761	5076

Dimensions

Width	63½	Seat Height	18½	Back Height	35¼	Weight	126
Depth	27	Seat Depth	20½	Back Width	34½	Cubic Ft.	68.4
Height	53¼	Seat Width	63½				

- Contrasting fabric option – specify X (i.e., N92HOU9X); see below. For list pricing, use your electronic specification tool or contact customer service
- Soft glide option available for a \$26 list upcharge

**High Back
Inside 90°
Wedge**

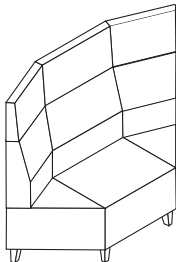

Model No.	Grade / List Price	Grade / List Price							
		1	2/COM	3/COL	4	6	7	L7	L8
N92HIN9	Inside 90°	\$ 3071	3214	3282	3381	3691	3945	5167	5557

Dimensions

Width	63½	Seat Height	18½	Back Height	35¼	Weight	158
Depth	27	Seat Depth	20½	Back Width	60	Cubic Ft.	68.4
Height	53¼	Seat Width	55				

- Contrasting fabric option – specify X (i.e., N92HIN9X); see below. For list pricing, use your electronic specification tool or contact customer service
- Soft glide option available for a \$26 list upcharge

To Order Contrasting Fabric, Specify:

1. Model Number plus "X"
2. Back Fabric Grade Number/Cover Number
3. Lumbar Fabric Grade Number/Cover Number
4. Seat Fabric Grade Number/Cover Number
5. Accent (headrest) Fabric Grade Number/Cover Number
6. Front Seat Grommet
7. Leg Color
8. Glides

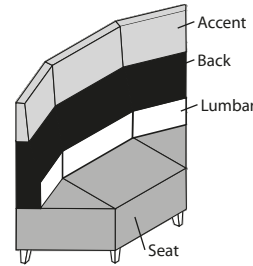

Contrasting Upholstery

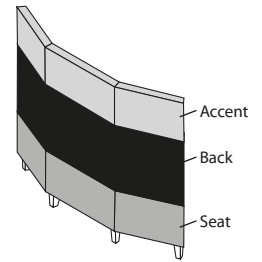

Contrasting Upholstery Back View

90° Wedge

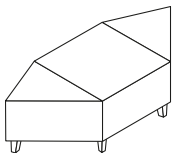

Model No.	Grade / List Price	Grade / List Price							
		1	2/COM	3/COL	4	6	7	L7	L8
N92B9	90° Wedge	\$ 1798	1865	1897	1943	2088	2207	2778	2961

Dimensions

Width	63½					Weight	81
Depth	27					Cubic Ft.	28.5
Height	18½						

- Soft glide option available for a \$26 list upcharge

Fringe

Bench To Order, Specify:

1. Model Number
 2. Fabric Grade / Cover Number
 3. Front Seat Grommet
 4. End Seat Grommet
 5. Leg Color
 6. Glides
- See page 149 for Fringe options

Club Chair To Order, Specify:

1. Model Number
 2. Fabric Grade / Cover Number
 3. Tablet Finish (when applicable)
 4. Base Color
- See page 149 for Fringe options

One Seat Bench

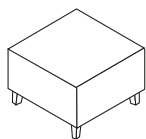

Model No.	Grade / List Price	Grade / List Price							
		1	2/COM	3/COL	4	6	7	L7	L8
N92B1	One Seat Bench	\$ 1241	1303	1333	1376	1511	1622	2154	2324

Dimensions

Width	27	Weight	40
Depth	27	Cubic Ft.	16.3
Height	18½		

- Soft glide option available for a \$26 list upcharge

Two Seat Bench

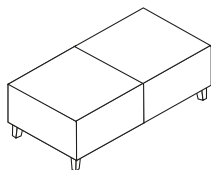

Model No.	Grade / List Price	Grade / List Price							
		1	2/COM	3/COL	4	6	7	L7	L8
N92B2	Two Seat Bench	\$ 1639	1740	1789	1859	2079	2259	3126	3403

Dimensions

Width	53½	Weight	75
Depth	27	Cubic Ft.	28.2
Height	18½		

- Soft glide option available for a \$26 list upcharge

Three Seat Bench

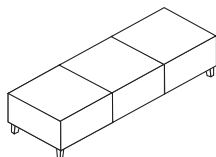

Model No.	Grade / List Price	Grade / List Price							
		1	2/COM	3/COL	4	6	7	L7	L8
N92B3	Three Seat Bench	\$ 2037	2177	2244	2342	2647	2897	4099	4483

Dimensions

Width	79¾	Weight	106
Depth	27	Cubic Ft.	43.3
Height	18½		

- Soft glide option available for a \$26 list upcharge

Club Chair

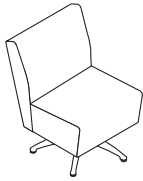

Armless Static

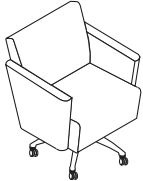

Arms, Mobile

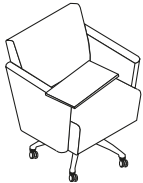

Tablet Right Arm

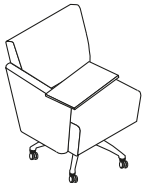

Right Arm, Right Tablet

Model No.

Grade / List Price

		1	2/COM	3/COL	4	6	7	L7	L8
N92CSM	Armless	\$ 1565	1620	1647	1685	1805	1903	2376	2527
N92CSMC	Armless, Mobile	1565	1620	1647	1685	1805	1903	2376	2527
N92CSA	Arms	2042	2123	2161	2217	2392	2536	3225	3446
N92CSAC	Arms, Mobile	2042	2123	2161	2217	2392	2536	3225	3446
N92CSAR	Arms, Right Tablet	2281	2362	2400	2456	2631	2775	3464	3685
N92CSARC	Arms, Right Tablet, Mobile	2281	2362	2400	2456	2631	2775	3464	3685
N92CSRR	Right Arm, Right Tablet	2040	2104	2135	2180	2320	2435	2986	3163
N92CSRRC	Right Arm, Right Tablet, Mobile	2040	2104	2135	2180	2320	2435	2986	3163
N92CSAL	Arms, Left Tablet	2281	2362	2400	2456	2631	2775	3464	3685
N92CSALC	Arms, Left Tablet, Mobile	2281	2362	2400	2456	2631	2775	3464	3685
N92CSLL	Left Arm, Left Tablet	2040	2104	2135	2180	2320	2435	2986	3163
N92CSLLC	Left Arm, Left Tablet, Mobile	2040	2104	2135	2180	2320	2435	2986	3163

Dimensions

Width	26¼	Seat Height	18½	Arm Height	26¾	Weight	59
Width with Arms	30½	Seat Depth	19	Back Height	18	Weight with Arms	81
Depth	28	Seat Width	23½	Back Width	23½	Weight with Tablet and One Arm	71
Height	34¼					Weight with Tablet and Two Arms	93
						Cubic Ft.	24.6

- Static models feature 360 degree swivel with auto-return
- Contrasting fabric option for arm model – specify X (i.e., N92CSAX); see below. For list pricing, use your electronic specification tool or contact customer service
- Soft glide option available for a \$26 list upcharge

To Order Contrasting Fabric, Specify:

1. Model Number plus “X”
2. Upholstery Fabric Grade Number/Cover Number
3. Arm Fabric Grade Number/Cover Number
4. Tablet Finish (when applicable)
5. Base Color

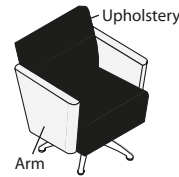

Contrasting Upholstery

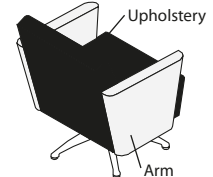

Contrasting Upholstery Back View

Ganging Bracket

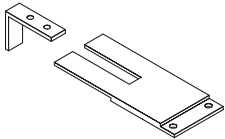

N92GB2	Ganging Bracket Kit	\$ 64
---------------	---------------------	-------

Dimensions

Weight	4
Cubic Ft.	0.1

- Ganging bracket kits includes required brackets to join two units together
- Once installed, units slide together for a secure connection
- To disconnect, lift up and pull outward

Fringe

To Order, Specify:

1. Model Number
 2. Finish/Laminate
- See page 149 for Fringe options

Personal Pull-up Table

Model No.	Grade / List Price
-----------	--------------------

10N1622RTPUW	Wood	\$ 955
--------------	------	--------

10N1622RTPUL	Laminate	955
--------------	----------	-----

Dimensions

Width	22	Weight	32
Depth	13¾	Cubic Ft.	9.25
Height	28½		

- 50 lb. weight limit
- Specify metal finish (462) Cinder, (501) Platinum Metallic, or (503) Satin Nickel Metallic
- Specify laminate or wood finish; **Laminates** (NM) Natural, (HN2) Honey 2, (CL) Caramel, (TF) Truffle, (AC2) Autumn 2, (MC) Amber, (CW) Cordovan, (DW) Judicial, (MH) Mocha, (405) Designer White, (462) Cinder, (791) Palisander, (792) Sable, or (793) Acorn; **Wood Finishes** (NM) Natural, (HN) Honey, (CL) Caramel, (TF) Truffle, (AC) Autumn, (MC) Amber, (CW) Cordovan, (DW) Judicial, (MH) Mocha, (405) Designer White, (462) Cinder, (792) Sable, or (793) Acorn

Fringe

FRINGE BISTRO PRODUCT SPECIFICATIONS

92 Series

FRAME CONSTRUCTION

- Interior frame is constructed of plywood with tenon joints that are glued and screwed for maximum joint stability
- Each joint is securely glued for maximum stability

SEAT CONSTRUCTION

- Lounge chairs feature 5½" of high grade polyurethane foam covering a plywood seat panel

BACK CONSTRUCTION

- Lounge chairs feature 1½" of high grade custom shaped polyurethane foam stretched over web sheet and attached to frame

ARM REST

- Lounge chairs feature plywood constructed arm frame covered with ¾" high grade polyurethane foam on arm surface and ⅜" on the sides

TABLET ARMS

- ¾" thick laminate with MDF core or ¾" thick plywood with veneer surface
- Attached with ¼" steel base plate with screws that mounts over a ¾" insert rod and fits into structure of arm
- Allows for 360 degree swivel and writing surface of 21" W x 13½" D
- Tablet height is 28½" from floor to top of tablet surface

LEGS AND GLIDES

- Die-cast aluminum legs available in polished or powder coated Cinder, Platinum Metallic or Satin Nickel Metallic
- Features a black 1" adjustable leveling glide
- Soft glides are available for an additional upcharge

UPHOLSTERY DETAIL

- Contrasting fabric available on all models, except benches and armless club chair

POWER GROMMET

- Features two electrical receptacles and two power USB ports

BISTRO TABLE

FRAME CONSTRUCTION

- Grade A slipmatched cherry or maple veneer or HPL and die-cast aluminum brackets
- Veneer table features National's IntegraClear® environmentally-friendly UV finish in a matte/satin sheen
- 50 lb. weight limit per seat location (i.e., 100 lb. weight limit for 2 seat, 150 lb. weight limit for 3 seat)
- 40" from top of table to floor

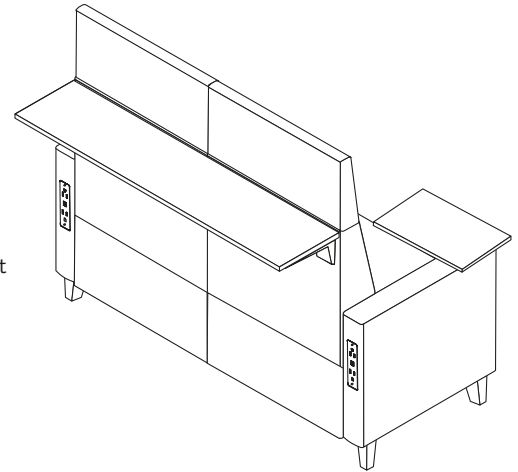

All Fringe models may be ordered to meet TB133 fire code.

To order seating to meet the TB133 fire code, specify an "F" at the end of the model number (Ex: N92M1MF).

Please consult customer service for applicable Arc-Com, COM, Maharam, Momentum, Stinson or Ultrafabrics fabric.



For comprehensive sustainability information that includes LEED® point contribution, visit NationalOfficeFurniture.ecoScorecard.com.

FABRICS

Grade 1	American Graffiti
	Cali
	Plush
	Ridge
	Speedway
	Stardust
Grade 2	Cathedral
	COM
	Orbit
	Pixie
	Sedona
	Shenanigans
	Spectrum
	Strand
	Tranquility
	Twilight

Grade 3	Boardwalk
	COL
	Jacks
	Pop Rocks
Grade 4	Big City
	Bumble
	Connect Four
	Echo
	Silvertex
Grade 6	Essence/Ultraleather
	Flock
	Scribe

Grade 7	Brisa
	Brisa Distressed
	Promessa
	Silica
Grade L7	Davenport
Grade L8	Showcase

TABLET ARM/BISTRO TABLE

W405	Wood, Designer White
W462	Wood, Cinder
W792	Wood, Sable
W793	Wood, Acorn
WAC	Wood, Autumn
WCL	Wood, Caramel
WCW	Wood, Cordovan
WDW	Wood, Judicial
WHN	Wood, Honey
WIM	Wood, Brighton
WMC	Wood, Amber
WMH	Wood, Mocha
WNM	Wood, Natural
WTF	Wood, Truffle
L405	Laminate, Designer White
L417	Laminate, Mojave
L418	Laminate, Mouse
L419	Laminate, Wallaby
L425	Laminate, Shadow
L440	Laminate, Cloud
L461	Laminate, Graphite
L462	Laminate, Cinder
L478	Laminate, Platinum Grey
L488	Laminate, Frosty White
L491	Laminate, Designer White Linear
L492	Laminate, Cinder Linear
L791	Laminate, Palisander
L792	Laminate, Sable
L793	Laminate, Acorn
LAC2	Laminate, Autumn 2
LCL	Laminate, Caramel
LCW	Laminate, Cordovan
LDW	Laminate, Judicial
LHN2	Laminate, Honey 2
LIM	Laminate, Brighton
LMC	Laminate, Amber
LMH	Laminate, Mocha
LNM	Laminate, Natural
LTF	Laminate, Truffle

LEG/BASE COLORS

Metal

462	Cinder
497	Polished Aluminum
501	Platinum Metallic
503	Satin Nickel Metallic

Wood (\$125 list upcharge per chair)

IM	Brighton	CW	Cordovan
NM	Natural	DW	Judicial
HN	Honey	MH	Mocha
CL	Caramel	405	Designer White
TF	Truffle	462	Cinder
AC	Autumn	792	Sable
MC	Amber	793	Acorn

VENEER FINISHES - BACK PANELS

IM	Brighton	CW	Cordovan
NM	Natural	DW	Judicial
HN	Honey	MH	Mocha
CL	Caramel	405	Designer White
TF	Truffle	462	Cinder
AC	Autumn	792	Sable
MC	Amber	793	Acorn

GLIDES

STD	Standard
C10	Soft (add \$26 list)

POWER GROMMET OPTIONS

(\$443 list upcharge per location)

G23BL	Black, Left
G23BR	Black, Right
G23BLR	Black, Left & Right
G23SL	Silver, Left
G23SR	Silver, Right
G23SLR	Silver, Left & Right
X	No Grommet

METAL BRACKETS

462	Cinder
497	Polished Aluminum
501	Platinum Metallic
503	Satin Nickel Metallic

LAMINATES - BACK PANELS

IM	Brighton	405	Designer White
NM	Natural	417	Mojave
HN2	Honey 2	418	Mouse
CL	Caramel	419	Wallaby
TF	Truffle	425	Shadow
AC2	Autumn 2	440	Cloud
MC	Amber	461	Graphite
CW	Cordovan	462	Cinder
DW	Judicial	478	Platinum Grey
MH	Mocha	488	Frosty White
*791	Palisander	491	Designer White Linear
792	Sable	492	Cinder Linear
793	Acorn		

*791 Palisander coordinates with (NM) Natural, (HN) Honey and (MH) Mocha finishes

Bistro with Power Grommets

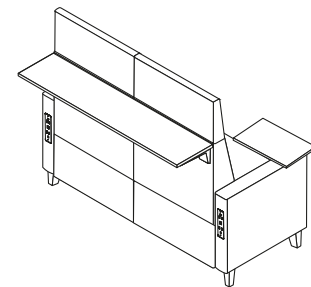
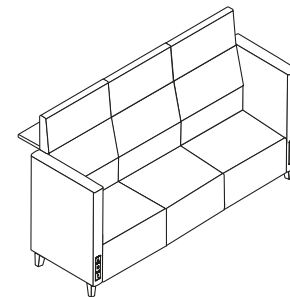

Fringe

To Order, Specify:

1. Model Number
2. Fabric Grade / Cover Number
3. Power Grommet - Front of Arm
4. Power Grommet - Back of Arm
5. Bistro Table Finish
6. Tablet and Finish (when applicable)
7. Finish/Laminate
8. Metal Bracket Color
9. Leg Color
10. Glides

• See page 149 for Fringe options

Bistro Table Mid Back Two Seat Lounge

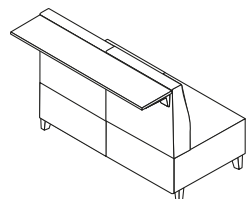

Armless - Upholstered Back

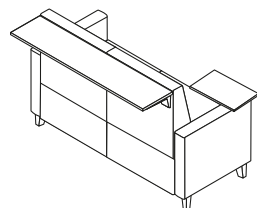

Tablet Right Arm - Upholstered Back

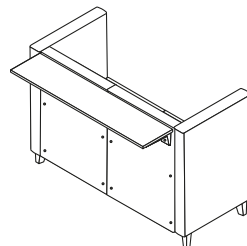

Mid Arms - Veneer or Laminate Back

Model No.	Grade / List Price									
		1	2/COM	3/COL	4	6	7	L7	L8	
Upholstered Back										
N92MTU2M	Armless, Upholstered Back	\$ 3124	3287	3365	3479	3834	4125	5524	5971	
N92MTU2B	Arm, Upholstered Back	3602	3827	3935	4092	4582	4984	6914	7532	
N92MTU2BR	Tablet Right Arm, Upholstered Back	3841	4066	4174	4331	4821	5223	7153	7771	
N92MTU2BL	Tablet Left Arm, Upholstered Back	3841	4066	4174	4331	4821	5223	7153	7771	
N92MTU2BB	Tablet Both Arms, Upholstered Back	4079	4304	4412	4569	5059	5461	7391	8009	
N92MTU2BM	Mid Arms, Upholstered Back	3911	4171	4295	4476	5041	5504	7730	8442	
Laminate Back										
N92MTL2M	Armless, Laminate Back	\$ 3973	4088	4143	4223	4473	4678	5663	5978	
N92MTL2B	Arm, Laminate Back	4451	4626	4709	4831	5211	5523	7020	7499	
N92MTL2BR	Tablet Right Arm, Laminate Back	4690	4865	4948	5070	5450	5762	7259	7738	
N92MTL2BL	Tablet Left Arm, Laminate Back	4690	4865	4948	5070	5450	5762	7259	7738	
N92MTL2BB	Tablet Both Arms, Laminate Back	4928	5103	5186	5308	5688	6000	7497	7976	
N92MTL2BM	Mid Arms, Laminate Back	4760	4969	5069	5215	5670	6043	7836	8409	
Veneer Back										
N92MTW2M	Armless, Veneer Back	\$ 3973	4088	4143	4223	4473	4678	5663	5978	
N92MTW2B	Arm, Veneer Back	4451	4626	4709	4831	5211	5523	7020	7499	
N92MTW2BR	Tablet Right Arm, Veneer Back	4690	4865	4948	5070	5450	5762	7259	7738	
N92MTW2BL	Tablet Left Arm, Veneer Back	4690	4865	4948	5070	5450	5762	7259	7738	
N92MTW2BB	Tablet Both Arms, Veneer Back	4928	5103	5186	5308	5688	6000	7497	7976	
N92MTW2BM	Mid Arms, Veneer Back	4760	4969	5069	5215	5670	6043	7836	8409	

Dimensions

Width	53½	Seat Height	18½	Arm Height	27½	Weight	187
Width with Arms	61½	Seat Depth	20½	Mid Arm Height	40¼	Weight with Arms	225
Depth	39	Seat Width	53½	Back Height	22½	Weight with Tablet	232
Height	40¼			Back Width	53½	Weight with Two Tablets	237
						Weight with Mid Arms	241
						Cubic Ft.	51.0
						Cubic Ft. with Tablet	56.9

- Power grommet only available on arm models (factory installed); specify grommet option (add \$443 list per grommet)
- Contrasting fabric option – specify X (i.e., N92MTU2MX); see next page. For list pricing, use your electronic specification tool or contact customer service
- Add 28.75 lbs. for laminate and veneer back models
- Some assembly required
- Soft glide option available for a \$26 list upcharge

**Bistro Table
Mid Back
Two Seat Lounge
Single Arm**

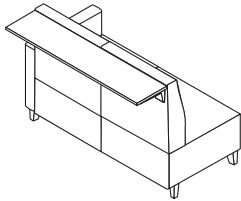

Left Arm - Upholstered Back

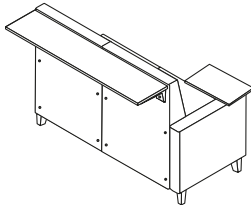

Tablet Right Arm -
Veneer or Laminate Back

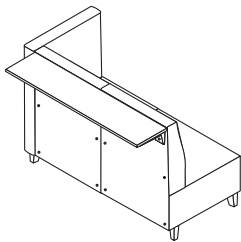

Left Mid Arm -
Veneer or Laminate Back

Model No.	Grade / List Price	Grade / List Price							
		1	2/COM	3/COL	4	6	7	L7	L8
Upholstered Back									
N92MTU2R	Right Arm, Upholstered Back	\$ 3363	3556	3649	3783	4203	4547	6202	6731
N92MTU2RR	Tablet Right Arm, Upholstered Back	3602	3795	3888	4022	4442	4786	6441	6970
N92MTU2RM	Right Mid Arm, Upholstered Back	3517	3729	3830	3977	4437	4814	6627	7206
N92MTU2L	Left Arm, Upholstered Back	3363	3556	3649	3783	4203	4547	6202	6731
N92MTU2LL	Tablet Left Arm, Upholstered Back	3602	3795	3888	4022	4442	4786	6441	6970
N92MTU2LM	Left Mid Arm, Upholstered Back	3517	3729	3830	3977	4437	4814	6627	7206
Laminate Back									
N92MTL2R	Right Arm, Laminate Back	\$ 4212	4357	4426	4527	4842	5100	6341	6738
N92MTL2RR	Tablet Right Arm, Laminate Back	4451	4596	4665	4766	5081	5339	6580	6977
N92MTL2RM	Right Mid Arm, Laminate Back	4366	4527	4604	4716	5066	5353	6732	7173
N92MTL2L	Left Arm, Laminate Back	4212	4357	4426	4527	4842	5100	6341	6738
N92MTL2LL	Tablet Left Arm, Laminate Back	4451	4596	4665	4766	5081	5339	6580	6977
N92MTL2LM	Left Mid Arm, Laminate Back	4366	4527	4604	4716	5066	5353	6732	7173
Veneer Back									
N92MTW2R	Right Arm, Veneer Back	\$ 4212	4357	4426	4527	4842	5100	6341	6738
N92MTW2RR	Tablet Right Arm, Veneer Back	4451	4596	4665	4766	5081	5339	6580	6977
N92MTW2RM	Right Mid Arm, Veneer Back	4366	4527	4604	4716	5066	5353	6732	7173
N92MTW2L	Left Arm, Veneer Back	4212	4357	4426	4527	4842	5100	6341	6738
N92MTW2LL	Tablet Left Arm, Veneer Back	4451	4596	4665	4766	5081	5339	6580	6977
N92MTW2LM	Left Mid Arm, Veneer Back	4366	4527	4604	4716	5066	5353	6732	7173

Dimensions

Width	57½	Seat Height	18½	Arm Height	27½	Weight	206
Depth	39	Seat Depth	20½	Mid Arm Height	40¼	Weight with Tablet	213
Height	40¼	Seat Width	53½	Back Height	22½	Weight with Mid Arm	214
				Back Width	53½	Cubic Ft.	51.0
						Cubic Ft. with Tablet	56.9

- Power grommet only available on arm models (factory installed); specify grommet option (add \$443 list per grommet)
- Contrasting fabric option – specify X (i.e., N92MTU2RX); see below. For list pricing, use your electronic specification tool or contact customer service
- Add 28.75 lbs. for laminate and veneer back models
- Some assembly required
- Soft glide option available for a \$26 list upcharge

To Order Contrasting Fabric, Specify:

1. Model Number plus "X"
2. Back Fabric Grade Number/Cover Number
3. Lumbar Fabric Grade Number/Cover Number
4. Seat Fabric Grade Number/Cover Number
5. Arm Fabric Grade Number/Cover Number
6. Power Grommet - Front of Arm
7. Power Grommet - Back of Arm
8. Bistro Table Finish
9. Tablet and Finish (when applicable)
10. Finish/Laminate
11. Leg Color
12. Glides

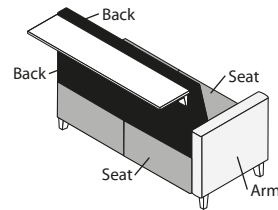

Contrasting Upholstery -
Upholstered Back

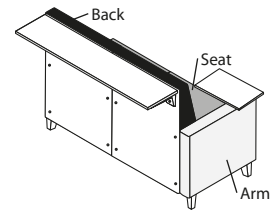

Contrasting Upholstery -
Veneer or Laminate Back

Fringe

To Order, Specify:

1. Model Number
2. Fabric Grade / Cover Number
3. Power Grommet - Front of Arm
4. Power Grommet - Back of Arm
5. Bistro Table Finish
6. Tablet and Finish (when applicable)
7. Finish/Laminate
8. Metal Bracket Color
9. Leg Color
10. Glides

• See page 149 for Fringe options

Bistro Table High Back Two Seat Lounge

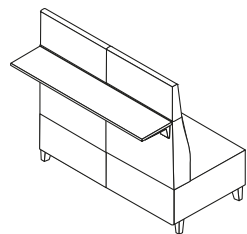

Armless - Upholstered Back

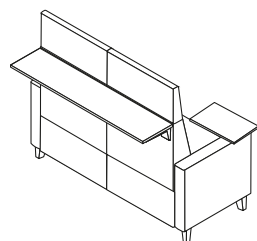

Tablet Right Arm - Upholstered Back

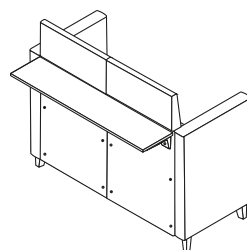

Mid Arms - Veneer or Laminate Back

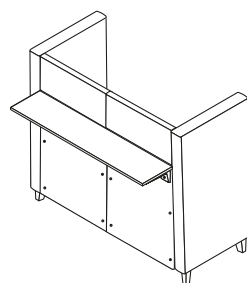

High Arms - Veneer or Laminate Back

Model No.	Grade / List Price									
		1	2/COM	3/COL	4	6	7	L7	L8	
Upholstered Back										
N92HTU2M	Armless, Upholstered Back	\$ 4185	4390	4488	4630	5075	5440	7193	7754	
N92HTU2B	Arm, Upholstered Back	4663	4928	5054	5238	5813	6285	8550	9275	
N92HTU2BR	Tablet Right Arm, Upholstered Back	4902	5167	5293	5477	6052	6524	8789	9514	
N92HTU2BL	Tablet Left Arm, Upholstered Back	4902	5167	5293	5477	6052	6524	8789	9514	
N92HTU2BB	Tablet Both Arms, Upholstered Back	5140	5405	5531	5715	6290	6762	9027	9752	
N92HTU2BM	Mid Arms, Upholstered Back	4972	5273	5417	5627	6282	6819	9400	10225	
N92HTU2BH	High Arms, Upholstered Back	5023	5357	5516	5748	6473	7068	9924	10838	
Laminate Back										
N92HTL2M	Armless, Laminate Back	\$ 5034	5188	5262	5369	5704	5979	7299	7721	
N92HTL2B	Arm, Laminate Back	5512	5682	5764	5882	6252	6555	8013	8479	
N92HTL2BR	Tablet Right Arm, Laminate Back	5750	5920	6002	6120	6490	6793	8251	8717	
N92HTL2BL	Tablet Left Arm, Laminate Back	5750	5920	6002	6120	6490	6793	8251	8717	
N92HTL2BB	Tablet Both Arms, Laminate Back	5988	6158	6240	6358	6728	7031	8489	8955	
N92HTL2BM	Mid Arms, Laminate Back	5821	6072	6192	6366	6911	7358	9505	10192	
N92HTL2BH	High Arms, Laminate Back	5872	6155	6290	6487	7102	7606	10029	10804	
Veneer Back										
N92HTW2M	Armless, Veneer Back	\$ 5034	5188	5262	5369	5704	5979	7299	7721	
N92HTW2B	Arm, Veneer Back	5512	5682	5764	5882	6252	6555	8013	8479	
N92HTW2BR	Tablet Right Arm, Veneer Back	5750	5920	6002	6120	6490	6793	8251	8717	
N92HTW2BL	Tablet Left Arm, Veneer Back	5750	5920	6002	6120	6490	6793	8251	8717	
N92HTW2BB	Tablet Both Arms, Veneer Back	5988	6158	6240	6358	6728	7031	8489	8955	
N92HTW2BM	Mid Arms, Veneer Back	5821	6072	6192	6366	6911	7358	9505	10192	
N92HTW2BH	High Arms, Veneer Back	5872	6155	6290	6487	7102	7606	10029	10804	

Dimensions

Width	53½	Seat Height	18½	Arm Height	27½	Weight	215
Width with Arms	61½	Seat Depth	20½	Mid Arm Height	40¼	Weight with Arms	253
Depth	39	Seat Width	53½	High Arm Height	53¾	Weight with Tablet	259
Height	53¾			Back Height	35¼	Weight with Two Tablets	264
				Back Width	53½	Weight with Mid Arms	269
						Weight with High Arms	285
						Cubic Ft.	64.9
						Cubic Ft. with Tablet	72.4

- Power grommet only available on arm models (factory installed); specify grommet option (add \$443 list per grommet)
- Contrasting fabric option – specify X (i.e., N92HTU2MX); see next page. For list pricing, use your electronic specification tool or contact customer service
- Add 28.75 lbs. for laminate and veneer back models
- Some assembly required
- Soft glide option available for a \$26 list upcharge

**Bistro Table
High Back
Two Seat Lounge
Single Arm**

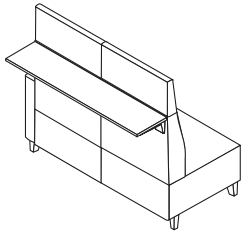

Left Arm - Upholstered Back

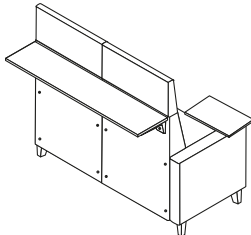

Tablet Right Arm -
Veneer or Laminate Back

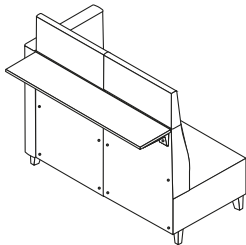

Left Mid Arm -
Veneer or Laminate Back

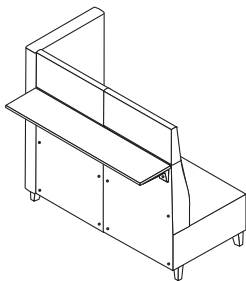

Left High Arm -
Veneer or Laminate Back

**Model
No.**

Grade / List Price

		1	2/COM	3/COL	4	6	7	L7	L8
<i>Upholstered Back</i>									
N92HTU2R	Right Arm, Upholstered Back	\$ 4424	4659	4771	4934	5444	5862	7872	8514
N92HTU2RR	Tablet Right Arm, Upholstered Back	4663	4898	5010	5173	5683	6101	8111	8753
N92HTU2RM	Right Mid Arm, Upholstered Back	4578	4831	4952	5128	5678	6129	8296	8989
N92HTU2RH	Right High Arm, Upholstered Back	4604	4873	5002	5189	5774	6254	8559	9296
N92HTU2L	Left Arm, Upholstered Back	4424	4659	4771	4934	5444	5862	7872	8514
N92HTU2LL	Tablet Left Arm, Upholstered Back	4663	4898	5010	5173	5683	6101	8111	8753
N92HTU2LM	Left Mid Arm, Upholstered Back	4578	4831	4952	5128	5678	6129	8296	8989
N92HTU2LH	Left High Arm, Upholstered Back	4604	4873	5002	5189	5774	6254	8559	9296
<i>Laminate Back</i>									
N92HTL2R	Right Arm, Laminate Back	\$ 5273	5459	5548	5678	6083	6415	8011	8521
N92HTL2RR	Tablet Right Arm, Laminate Back	5512	5698	5787	5917	6322	6654	8250	8760
N92HTL2RM	Right Mid Arm, Laminate Back	5427	5629	5726	5867	6307	6668	8401	8956
N92HTL2RH	Right High Arm, Laminate Back	5453	5672	5776	5928	6403	6793	8664	9263
N92HTL2L	Left Arm, Laminate Back	5273	5459	5548	5678	6083	6415	8011	8521
N92HTL2LL	Tablet Left Arm, Laminate Back	5512	5698	5787	5917	6322	6654	8250	8760
N92HTL2LM	Left Mid Arm, Laminate Back	5427	5629	5726	5867	6307	6668	8401	8956
N92HTL2LH	Left High Arm, Laminate Back	5453	5672	5776	5928	6403	6793	8664	9263
<i>Veneer Back</i>									
N92HTW2R	Right Arm, Veneer Back	\$ 5273	5459	5548	5678	6083	6415	8011	8521
N92HTW2RR	Tablet Right Arm, Veneer Back	5512	5698	5787	5917	6322	6654	8250	8760
N92HTW2RM	Right Mid Arm, Veneer Back	5427	5629	5726	5867	6307	6668	8401	8956
N92HTW2RH	Right High Arm, Veneer Back	5453	5672	5776	5928	6403	6793	8664	9263
N92HTW2L	Left Arm, Veneer Back	5273	5459	5548	5678	6083	6415	8011	8521
N92HTW2LL	Tablet Left Arm, Veneer Back	5512	5698	5787	5917	6322	6654	8250	8760
N92HTW2LM	Left Mid Arm, Veneer Back	5427	5629	5726	5867	6307	6668	8401	8956
N92HTW2LH	Left High Arm, Veneer Back	5453	5672	5776	5928	6403	6793	8664	9263

Dimensions

Width	57½	Seat Height	18½	Arm Height	27½	Weight	234
Depth	39	Seat Depth	20½	Mid Arm Height	40¼	Weight with Tablet	240
Height	53¾	Seat Width	53½	High Arm Height	53¾	Weight with Mid Arm	242
				Back Height	35¼	Weight with High Arm	250
				Back Width	53½	Cubic Ft.	64.9
						Cubic Ft. with Tablet	72.4

- Power grommet only available on arm models (factory installed); specify grommet option (add \$443 list per grommet)
- Contrasting fabric option – specify X (i.e., N92HTU2RX); see below. For list pricing, use your electronic specification tool or contact customer service
- Add 28.75 lbs. for laminate and veneer back models
- Some assembly required
- Soft glide option available for a \$26 list upcharge

To Order Contrasting Fabric, Specify:

1. Model Number plus "X"
2. Back Fabric Grade Number/Cover Number
3. Lumbar Fabric Grade Number/Cover Number
4. Seat Fabric Grade Number/Cover Number
5. Arm Fabric Grade Number/Cover Number
6. Accent (headrest) Fabric Grade Number/Cover Number
7. Power Grommet - Front of Arm
8. Power Grommet - Back of Arm
9. Bistro Table Finish
10. Tablet and Finish (when applicable)
11. Finish/Laminate
12. Leg Color
13. Glides

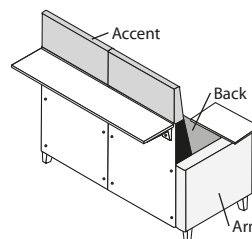

Contrasting Upholstery -
Veneer or Laminate Back

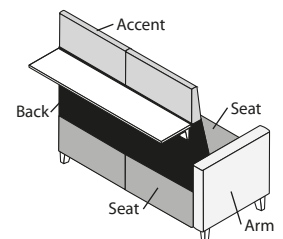

Contrasting Upholstery -
Upholstered Back

Fringe

To Order, Specify:

1. Model Number
2. Fabric Grade / Cover Number
3. Power Grommet - Front of Arm
4. Power Grommet - Back of Arm
5. Bistro Table Finish
6. Tablet and Finish (when applicable)
7. Finish/Laminate
8. Metal Bracket Color
9. Leg Color
10. Glides

• See page 149 for Fringe options

Bistro Table Mid Back Three Seat Lounge

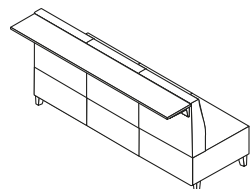

Armless - Upholstered Back

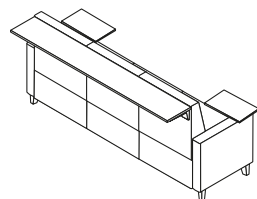

Tablet Right Arm - Upholstered Back

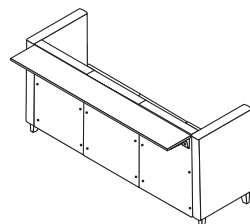

Mid Arms - Veneer or Laminate Back

Model No.	Grade / List Price									
		1	2/COM	3/COL	4	6	7	L7	L8	
Upholstered Back										
N92MTU3M	Armless, Upholstered Back	\$ 4265	4497	4608	4770	5275	5689	7679	8315	
N92MTU3B	Arm, Upholstered Back	4742	5036	5177	5382	6022	6547	9068	9875	
N92MTU3BR	Tablet Right Arm, Upholstered Back	4981	5275	5416	5621	6261	6786	9307	10114	
N92MTU3BL	Tablet Left Arm, Upholstered Back	4981	5275	5416	5621	6261	6786	9307	10114	
N92MTU3BB	Tablet Both Arms, Upholstered Back	5220	5514	5655	5860	6500	7025	9546	10353	
N92MTU3BM	Mid Arms, Upholstered Back	5051	5380	5537	5766	6481	7067	9884	10785	
Laminate Back										
N92MTL3M	Armless, Laminate Back	\$ 5538	5697	5773	5883	6228	6511	7870	8305	
N92MTL3B	Arm, Laminate Back	6015	6236	6341	6495	6975	7369	9260	9865	
N92MTL3BR	Tablet Right Arm, Laminate Back	6254	6475	6580	6734	7214	7608	9499	10104	
N92MTL3BL	Tablet Left Arm, Laminate Back	6254	6475	6580	6734	7214	7608	9499	10104	
N92MTL3BB	Tablet Both Arms, Laminate Back	6493	6714	6819	6973	7453	7847	9738	10343	
N92MTL3BM	Mid Arms, Laminate Back	6324	6579	6701	6879	7434	7889	10076	10775	
Veneer Back										
N92MTW3M	Armless, Veneer Back	\$ 5538	5697	5773	5883	6228	6511	7870	8305	
N92MTW3B	Arm, Veneer Back	6015	6236	6341	6495	6975	7369	9260	9865	
N92MTW3BR	Tablet Right Arm, Veneer Back	6254	6475	6580	6734	7214	7608	9499	10104	
N92MTW3BL	Tablet Left Arm, Veneer Back	6254	6475	6580	6734	7214	7608	9499	10104	
N92MTW3BB	Tablet Both Arms, Veneer Back	6493	6714	6819	6973	7453	7847	9738	10343	
N92MTW3BM	Mid Arms, Veneer Back	6324	6579	6701	6879	7434	7889	10076	10775	

Dimensions

Width	79¾	Seat Height	18½	Arm Height	27½	Weight	260
Width with Arms	87¾	Seat Depth	20½	Mid Arm Height	40¼	Weight with Arms	298
Depth	39	Seat Width	79¾	Back Height	22½	Weight with Tablet	304
Height	40¼			Back Width	79¾	Weight with Two Tablets	309
						Weight with Mid Arms	314
						Cubic Ft.	72.2
						Cubic Ft. with Tablet	79.2

- Power grommet only available on arm models (factory installed); specify grommet option (add \$443 list per grommet)
- Contrasting fabric option – specify X (i.e., N92MTU3MX); see next page. For list pricing, use your electronic specification tool or contact customer service
- Add 43 lbs. for laminate and veneer back models
- Some assembly required
- Soft glide option available for a \$26 list upcharge

**Bistro Table
Mid Back
Three Seat Lounge
Single Arm**

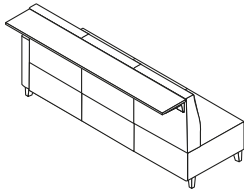

Left Arm - Upholstered Back

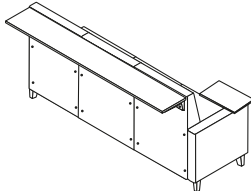

Tablet Right Arm - Veneer or Laminate Back

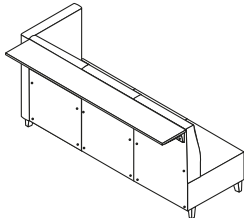

Left Mid Arm - Veneer or Laminate Back

Model No.	Grade / List Price								
		1	2/COM	3/COL	4	6	7	L7	L8
Upholstered Back									
N92MTU3R	Right Arm, Upholstered Back	\$ 4503	4768	4894	5078	5653	6125	8390	9115
N92MTU3RR	Tablet Right Arm, Upholstered Back	4742	5007	5133	5317	5892	6364	8629	9354
N92MTU3RM	Right Mid Arm, Upholstered Back	4658	4939	5073	5268	5878	6378	8782	9550
N92MTU3L	Left Arm, Upholstered Back	4503	4768	4894	5078	5653	6125	8390	9115
N92MTU3LL	Tablet Left Arm, Upholstered Back	4742	5007	5133	5317	5892	6364	8629	9354
N92MTU3LM	Left Mid Arm, Upholstered Back	4658	4939	5073	5268	5878	6378	8782	9550
Laminate Back									
N92MTL3R	Right Arm, Laminate Back	\$ 5776	5967	6058	6191	6606	6946	8581	9104
N92MTL3RR	Tablet Right Arm, Laminate Back	6015	6206	6297	6430	6845	7185	8820	9343
N92MTL3RM	Right Mid Arm, Laminate Back	5931	6138	6237	6381	6831	7200	8973	9540
N92MTL3L	Left Arm, Laminate Back	5776	5967	6058	6191	6606	6946	8581	9104
N92MTL3LL	Tablet Left Arm, Laminate Back	6015	6206	6297	6430	6845	7185	8820	9343
N92MTL3LM	Left Mid Arm, Laminate Back	5931	6138	6237	6381	6831	7200	8973	9540
Veneer Back									
N92MTW3R	Right Arm, Veneer Back	\$ 5776	5967	6058	6191	6606	6946	8581	9104
N92MTW3RR	Tablet Right Arm, Veneer Back	6015	6206	6297	6430	6845	7185	8820	9343
N92MTW3RM	Right Mid Arm, Veneer Back	5931	6138	6237	6381	6831	7200	8973	9540
N92MTW3L	Left Arm, Veneer Back	5776	5967	6058	6191	6606	6946	8581	9104
N92MTW3LL	Tablet Left Arm, Veneer Back	6015	6206	6297	6430	6845	7185	8820	9343
N92MTW3LM	Left Mid Arm, Veneer Back	5931	6138	6237	6381	6831	7200	8973	9540

Dimensions

Width	83¾	Seat Height	18½	Arm Height	27½	Weight	279
Depth	39	Seat Depth	20½	Mid Arm Height	40¼	Weight with Tablet	285
Height	40¼	Seat Width	79¾	Back Height	22½	Weight with Mid Arm	287
				Back Width	79¾	Cubic Ft.	72.2
						Cubic Ft. with Tablet	79.2

- Power grommet only available on arm models (factory installed); specify grommet option (add \$443 list per grommet)
- Contrasting fabric option – specify X (i.e., N92MTU3RX); see below. For list pricing, use your electronic specification tool or contact customer service
- Add 43 lbs. for laminate and veneer back models
- Some assembly required
- Soft glide option available for a \$26 list upcharge

To Order Contrasting Fabric, Specify:

1. Model Number plus "X"
2. Back Fabric Grade Number/Cover Number
3. Lumbar Fabric Grade Number/Cover Number
4. Seat Fabric Grade Number/Cover Number
5. Arm Fabric Grade Number/Cover Number
6. Power Grommet - Front of Arm
7. Power Grommet - Back of Arm
8. Bistro Table Finish
9. Tablet and Finish (when applicable)
10. Finish/Laminate
11. Leg Color
12. Glides

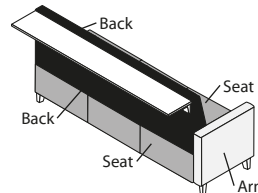

Contrasting Upholstery - Upholstered Back

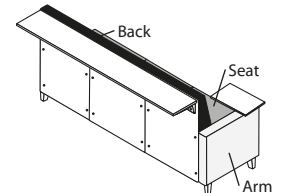

Contrasting Upholstery - Veneer or Laminate Back

Fringe

To Order, Specify:

1. Model Number
2. Fabric Grade / Cover Number
3. Power Grommet - Front of Arm
4. Power Grommet - Back of Arm
5. Bistro Table Finish
6. Tablet and Finish (when applicable)
7. Finish/Laminate
8. Metal Bracket Color
9. Leg Color
10. Glides

• See page 149 for Fringe options

Bistro Table High Back Three Seat Lounge

Model
No.

Grade / List Price

1 2/COM 3/COL 4 6 7 L7 L8

Upholstered Back

N92HTU3M	Armless, Upholstered Back	\$ 5326	5618	5758	5961	6596	7117	9619	10419
N92HTU3B	Arm, Upholstered Back	5803	6157	6327	6573	7343	7974	11008	11978
N92HTU3BR	Tablet Right Arm, Upholstered Back	6042	6396	6566	6812	7582	8213	11247	12217
N92HTU3BL	Tablet Left Arm, Upholstered Back	6042	6396	6566	6812	7582	8213	11247	12217
N92HTU3BB	Tablet Both Arms, Upholstered Back	6281	6635	6805	7051	7821	8452	11486	12456
N92HTU3BM	Mid Arms, Upholstered Back	6112	6503	6690	6962	7812	8509	11858	12929
N92HTU3BH	High Arms, Upholstered Back	6164	6587	6790	7084	8004	8758	12383	13542

Laminate Back

N92HTL3M	Armless, Laminate Back	\$ 6599	6820	6925	7079	7559	7953	9844	10449
N92HTL3B	Arm, Laminate Back	7076	7359	7494	7691	8306	8810	11233	12008
N92HTL3BR	Tablet Right Arm, Laminate Back	7315	7598	7733	7930	8545	9049	11472	12247
N92HTL3BL	Tablet Left Arm, Laminate Back	7315	7598	7733	7930	8545	9049	11472	12247
N92HTL3BB	Tablet Both Arms, Laminate Back	7554	7837	7972	8169	8784	9288	11711	12486
N92HTL3BM	Mid Arms, Laminate Back	7385	7700	7851	8070	8755	9317	12016	12879
N92HTL3BH	High Arms, Laminate Back	7437	7787	7954	8197	8957	9580	12575	13532

Veneer Back

N92HTW3M	Armless, Veneer Back	\$ 6599	6820	6925	7079	7559	7953	9844	10449
N92HTW3B	Arm, Veneer Back	7076	7359	7494	7691	8306	8810	11233	12008
N92HTW3BR	Tablet Right Arm, Veneer Back	7315	7598	7733	7930	8545	9049	11472	12247
N92HTW3BL	Tablet Left Arm, Veneer Back	7315	7598	7733	7930	8545	9049	11472	12247
N92HTW3BB	Tablet Both Arms, Veneer Back	7554	7837	7972	8169	8784	9288	11711	12486
N92HTW3BM	Mid Arms, Veneer Back	7385	7700	7851	8070	8755	9317	12016	12879
N92HTW3BH	High Arms, Veneer Back	7437	7787	7954	8197	8957	9580	12575	13532

Dimensions

Width	79¾	Seat Height	18½	Arm Height	27½	Weight	300
Width with Arms	87¾	Seat Depth	20½	Mid Arm Height	40¼	Weight with Arms	338
Depth	39	Seat Width	79¾	High Arm Height	53¾	Weight with Tablet	345
Height	53¾			Back Height	35¼	Weight with Two Tablets	350
				Back Width	79¾	Weight with Mid Arms	354
						Weight with High Arms	370
						Cubic Ft.	91.9
						Cubic Ft. with Tablet	100.7

- Power grommet only available on arm models (factory installed); specify grommet option (add \$443 list per grommet)
- Contrasting fabric option – specify X (i.e., N92HTU3MX); see next page. For list pricing, use your electronic specification tool or contact customer service
- Add 43 lbs. for laminate and veneer back models
- Some assembly required
- Soft glide option available for a \$26 list upcharge

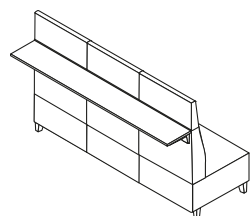

Armless - Upholstered Back

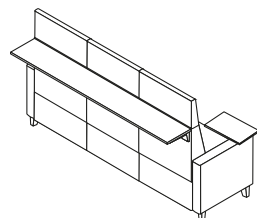

Tablet Right Arm - Upholstered Back

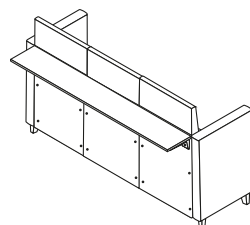

Mid Arms - Veneer or Laminate Back

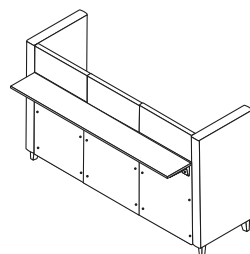

High Arms - Veneer or Laminate Back

**Bistro Table
High Back
Three Seat Lounge
Single Arm**

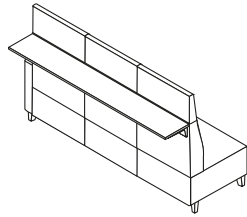

Left Arm - Upholstered Back

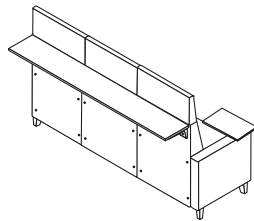

Tablet Right Arm -
Veneer or Laminate Back

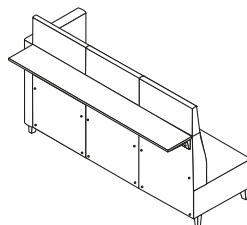

Left Mid Arm -
Veneer or Laminate Back

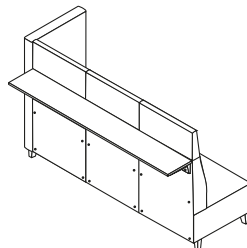

Left High Arm -
Veneer or Laminate Back

Model No.	Grade / List Price								
		1	2/COM	3/COL	4	6	7	L7	L8
Upholstered Back									
N92HTU3R	Right Arm, Upholstered Back	\$ 5564	5888	6043	6269	6974	7552	10330	11218
N92HTU3RR	Tablet Right Arm, Upholstered Back	5803	6127	6282	6508	7213	7791	10569	11457
N92HTU3RM	Right Mid Arm, Upholstered Back	5719	6062	6226	6464	7209	7820	10755	11694
N92HTU3RH	Right High Arm, Upholstered Back	5744	6103	6274	6524	7304	7944	11017	12000
N92HTU3L	Left Arm, Upholstered Back	5564	5888	6043	6269	6974	7552	10330	11218
N92HTU3LL	Tablet Left Arm, Upholstered Back	5803	6127	6282	6508	7213	7791	10569	11457
N92HTU3LM	Left Mid Arm, Upholstered Back	5719	6062	6226	6464	7209	7820	10755	11694
N92HTU3LH	Left High Arm, Upholstered Back	5744	6103	6274	6524	7304	7944	11017	12000
Laminate Back									
N92HTL3R	Right Arm, Laminate Back	\$ 6837	7088	7208	7382	7927	8374	10521	11208
N92HTL3RR	Tablet Right Arm, Laminate Back	7076	7327	7447	7621	8166	8613	10760	11447
N92HTL3RM	Right Mid Arm, Laminate Back	6992	7261	7390	7577	8162	8642	10947	11684
N92HTL3RH	Right High Arm, Laminate Back	7017	7300	7435	7632	8247	8751	11174	11949
N92HTL3L	Left Arm, Laminate Back	6837	7088	7208	7382	7927	8374	10521	11208
N92HTL3LL	Tablet Left Arm, Laminate Back	7076	7327	7447	7621	8166	8613	10760	11447
N92HTL3LM	Left Mid Arm, Laminate Back	6992	7261	7390	7577	8162	8642	10947	11684
N92HTL3LH	Left High Arm, Laminate Back	7017	7300	7435	7632	8247	8751	11174	11949
Veneer Back									
N92HTW3R	Right Arm, Veneer Back	\$ 6837	7088	7208	7382	7927	8374	10521	11208
N92HTW3RR	Tablet Right Arm, Veneer Back	7076	7327	7447	7621	8166	8613	10760	11447
N92HTW3RM	Right Mid Arm, Veneer Back	6992	7261	7390	7577	8162	8642	10947	11684
N92HTW3RH	Right High Arm, Veneer Back	7017	7300	7435	7632	8247	8751	11174	11949
N92HTW3L	Left Arm, Veneer Back	6837	7088	7208	7382	7927	8374	10521	11208
N92HTW3LL	Tablet Left Arm, Veneer Back	7076	7327	7447	7621	8166	8613	10760	11447
N92HTW3LM	Left Mid Arm, Veneer Back	6992	7261	7390	7577	8162	8642	10947	11684
N92HTW3LH	Left High Arm, Veneer Back	7017	7300	7435	7632	8247	8751	11174	11949

Dimensions

Width	83¾	Seat Height	18½	Arm Height	27½	Weight	319
Depth	39	Seat Depth	20½	Mid Arm Height	40¼	Weight with Tablet	326
Height	53¾	Seat Width	79¾	High Arm Height	53¾	Weight with Mid Arms	327
				Back Height	35¼	Weight with High Arms	335
				Back Width	79¾	Cubic Ft.	91.9
						Cubic Ft. with Tablet	100.7

- Power grommet only available on arm models (factory installed); specify grommet option (add \$443 list per grommet)
- Contrasting fabric option – specify X (i.e., N92HTU3RX); see below. For list pricing, use your electronic specification tool or contact customer service
- Add 43 lbs. for laminate and veneer back models
- Some assembly required
- Soft glide option available for a \$26 list upcharge

To Order Contrasting Fabric, Specify:

1. Model Number plus "X"
2. Back Fabric Grade Number/Cover Number
3. Lumbar Fabric Grade Number/Cover Number
4. Seat Fabric Grade Number/Cover Number
5. Arm Fabric Grade Number/Cover Number
6. Accent (headrest) Fabric Grade Number/Cover Number
7. Power Grommet - Front of Arm
8. Power Grommet - Back of Arm
9. Bistro Table Finish
10. Tablet and Finish (when applicable)
11. Finish/Laminate
12. Leg Color
13. Glides

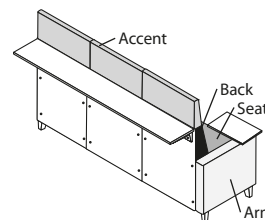

Contrasting Upholstery -
Veneer or Laminate Back

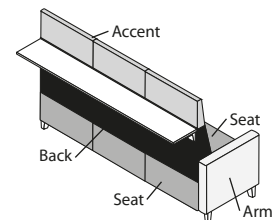

Contrasting Upholstery -
Upholstered Back

Fringe

To Order, Specify:

1. Model Number
2. Fabric Grade / Cover Number
3. Bistro Table Finish
4. Finish/Laminate (when applicable)
5. Metal Bracket Color
6. Leg Color
7. Glides

• See page 149 for Fringe options

Bistro Table Mid Back Two Seat Cove

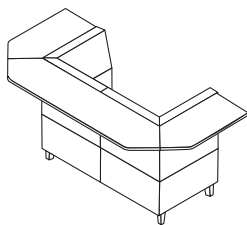

Upholstered Back

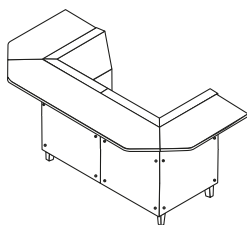

Veneer or Laminate Back

Model No.	Grade / List Price									
		1	2/COM	3/COL	4	6	7	L7	L8	
N92MTUC2	Upholstered Back	\$ 4694	4846	4918	5024	5354	5625	6925	7341	
N92MTLC2	Laminate Back	5518	5592	5627	5678	5838	5969	6600	6801	
N92MTWC2	Veneer Back	5518	5592	5627	5678	5838	5969	6600	6801	

Dimensions

Width	53¾	Seat Height	18½	Back Height	22½	Weight	184
Depth	27	Seat Depth	20½	Back Width	53½	Cubic Ft.	37.0
Height	40¼	Seat Width	53½				

- Contrasting fabric option – specify X (i.e., N92MTUC2X); see next page. For list pricing, use your electronic specification tool or contact customer service
- Power grommet option not available
- Soft glide option available for a \$26 list upcharge

Bistro Table High Back Two Seat Cove

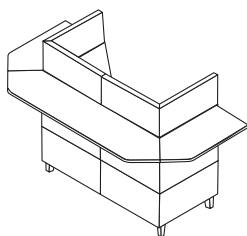

Upholstered Back

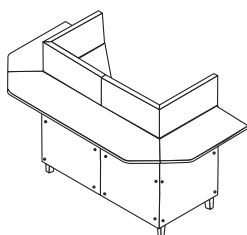

Veneer or Laminate Back

Model No.	Grade / List Price									
		1	2/COM	3/COL	4	6	7	L7	L8	
N92HTUC2	Upholstered Back	\$ 6206	6418	6519	6666	7126	7503	9316	9895	
N92HTLC2	Laminate Back	7030	7147	7203	7285	7540	7749	8754	9075	
N92HTWC2	Veneer Back	7030	7147	7203	7285	7540	7749	8754	9075	

Dimensions

Width	53¾	Seat Height	18½	Back Height	35¼	Weight	238
Depth	27	Seat Depth	20½	Back Width	53½	Cubic Ft.	37.0
Height	53¼	Seat Width	53½				

- Contrasting fabric option – specify X (i.e., N92HTUC2X); see next page. For list pricing, use your electronic specification tool or contact customer service
- Power grommet option not available
- Soft glide option available for a \$26 list upcharge

**Bistro Table
Mid Back
Three Seat Cove**

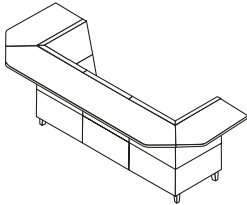

Upholstered Back

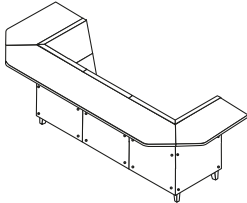

Veneer or Laminate Back

Model No.

Grade / List Price

		1	2/COM	3/COL	4	6	7	L7	L8
N92MTUC3	Upholstered Back	\$ 6176	6445	6574	6761	7346	7826	10131	10868
N92MTLC3	Laminate Back	7412	7511	7558	7627	7842	8018	8865	9136
N92MTWC3	Veneer Back	7412	7511	7558	7627	7842	8018	8865	9136

Dimensions

Width	80¼	Seat Height	18½	Back Height	22½	Weight	253
Depth	27	Seat Depth	20½	Back Width	79¾	Cubic Ft.	47.0
Height	40¼	Seat Width	79¾				

- Contrasting fabric option – specify X (i.e., N92MTUC3X); see below. For list pricing, use your electronic specification tool or contact customer service
- Power grommet option not available
- Soft glide option available for a \$26 list upcharge

**Bistro Table
High Back
Three Seat Cove**

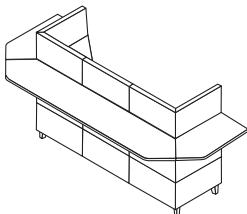

Upholstered Back

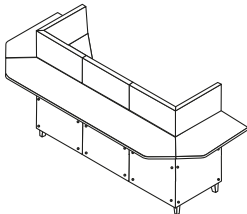

Veneer or Laminate Back

		1	2/COM	3/COL	4	6	7	L7	L8
N92HTUC3	Upholstered Back	\$ 8192	8560	8736	8992	9792	10448	13600	14608
N92HTLC3	Laminate Back	9428	9584	9659	9768	10108	10387	11726	12155
N92HTWC3	Veneer Back	9428	9584	9659	9768	10108	10387	11726	12155

Dimensions

Width	80¼	Seat Height	18½	Back Height	35¼	Weight	321
Depth	27	Seat Depth	20½	Back Width	79¾	Cubic Ft.	47.0
Height	53¼	Seat Width	79¾				

- Contrasting fabric option – specify X (i.e., N92HTUC3X); see below. For list pricing, use your electronic specification tool or contact customer service
- Power grommet option not available
- Soft glide option available for a \$26 list upcharge

To Order Contrasting Fabric, Specify:

1. Model Number plus "X"
2. Back Fabric Grade Number/Cover Number
3. Lumbar Fabric Grade Number/Cover Number
4. Seat Fabric Grade Number/Cover Number
5. Accent (headrest) Fabric Grade Number/Cover Number (when applicable)
6. Bistro Table Finish
7. Finish/Laminate (when applicable)
8. Leg Color
9. Glides

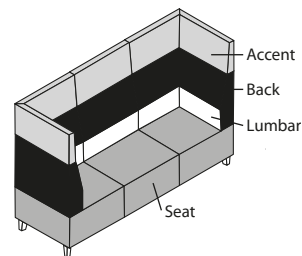

Contrasting Upholstery

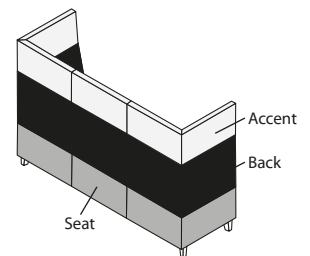

Contrasting Upholstery Back View

Fringe

To Order, Specify:

1. Model Number
2. Fabric Grade / Cover Number
3. Bistro Table Finish
4. Finish/Laminate (when applicable)
5. Metal Bracket Color
6. Leg Color
7. Glides

• See page 149 for Fringe options

**Bistro Table
Mid Back
Square 90°
Corner**

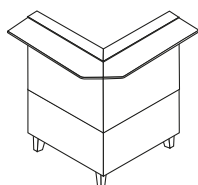

Upholstered Back

Model No.	Grade / List Price	Grade / List Price							
		1	2/COM	3/COL	4	6	7	L7	L8
Upholstered Back									
N92MTUSQ9R	Square 90°, Upholstered Back, Right	\$ 2861	2948	2990	3051	3241	3397	4145	4385
N92MTUSQ9L	Square 90°, Upholstered Back, Left	2861	2948	2990	3051	3241	3397	4145	4385
N92MTUSQ9D	Square 90°, Upholstered Back, Diagonal	2861	2960	3007	3076	3291	3467	4314	4585
Laminate Back									
N92MTLSQ9R	Square 90°, Laminate Back, Right	\$ 3685	3733	3756	3790	3895	3981	4395	4527
N92MTLSQ9L	Square 90°, Laminate Back, Left	3685	3733	3756	3790	3895	3981	4395	4527
N92MTLSQ9D	Square 90°, Laminate Back, Diagonal	3685	3738	3763	3800	3915	4009	4462	4607
Veneer Back									
N92MTWSQ9R	Square 90°, Veneer Back, Right	\$ 3685	3733	3756	3790	3895	3981	4395	4527
N92MTWSQ9L	Square 90°, Veneer Back, Left	3685	3733	3756	3790	3895	3981	4395	4527
N92MTWSQ9D	Square 90°, Veneer Back, Diagonal	3685	3738	3763	3800	3915	4009	4462	4607

Dimensions

Width	27	Seat Height	18½	Back Height	22½	Weight	92
Depth	27	Seat Depth	20½	Back Width	20½	Cubic Ft.	24.0
Height	40¼	Seat Width	20½				

- Contrasting fabric option – specify X (i.e., N92MTUSQ9RX); see next page. For list pricing, use your electronic specification tool or contact customer service
- Diagonal model is recommended for directional fabrics
- Power grommet option not available
- Soft glide option available for a \$26 list upcharge

**Bistro Table
High Back
Square 90°
Corner**

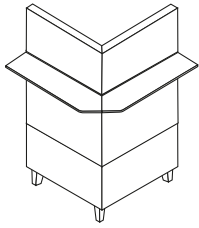

Upholstered Back

Model No.	Grade / List Price	Grade / List Price							
		1	2/COM	3/COL	4	6	7	L7	L8
Upholstered Back									
N92HTUSQ9R	Square 90°, Upholstered Back, Right	\$ 3657	3774	3830	3912	4167	4376	5381	5702
N92HTUSQ9L	Square 90°, Upholstered Back, Left	3657	3774	3830	3912	4167	4376	5381	5702
N92HTUSQ9D	Square 90°, Upholstered Back, Diagonal	3657	3784	3844	3932	4207	4433	5516	5863
Laminate Back									
N92HTLSQ9R	Square 90°, Laminate Back, Right	\$ 4481	4550	4583	4631	4781	4904	5495	5684
N92HTLSQ9L	Square 90°, Laminate Back, Left	4481	4550	4583	4631	4781	4904	5495	5684
N92HTLSQ9D	Square 90°, Laminate Back, Diagonal	4481	4557	4593	4646	4811	4946	5596	5804
Veneer Back									
N92HTWSQ9R	Square 90°, Veneer Back, Right	\$ 4481	4550	4583	4631	4781	4904	5495	5684
N92HTWSQ9L	Square 90°, Veneer Back, Left	4481	4550	4583	4631	4781	4904	5495	5684
N92HTWSQ9D	Square 90°, Veneer Back, Diagonal	4481	4557	4593	4646	4811	4946	5596	5804

Dimensions

Width	27	Seat Height	18½	Back Height	22½	Weight	119
Depth	27	Seat Depth	20½	Back Width	20½	Cubic Ft.	24.0
Height	53¼	Seat Width	20½				

- Contrasting fabric option – specify X (i.e., N92HTUSQ9RX); see below. For list pricing, use your electronic specification tool or contact customer service
- Diagonal model is recommended for directional fabrics
- Power grommet option not available
- Soft glide option available for a \$26 list upcharge

To Order Contrasting Fabric, Specify:

1. Model Number plus “X”
2. Back Fabric Grade Number/Cover Number
3. Lumbar Fabric Grade Number/Cover Number
4. Seat Fabric Grade Number/Cover Number
5. Accent (headrest) Fabric Grade Number/Cover Number (when applicable)
6. Bistro Table Finish
7. Finish/Laminate (when applicable)
8. Leg Color
9. Glides

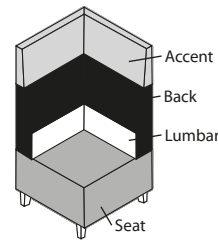

Contrasting Upholstery

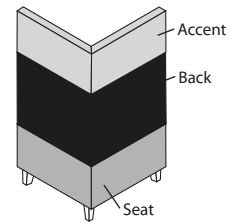

Contrasting Upholstery Back View

Fringe

To Order, Specify:

1. Model Number
2. Fabric Grade / Cover Number
3. Bistro Table Finish
4. Finish/Laminate (when applicable)
5. Metal Bracket Color
6. Leg Color
7. Glides

• See page 149 for Fringe options

Bistro Table Mid Back Inside 90° Wedge

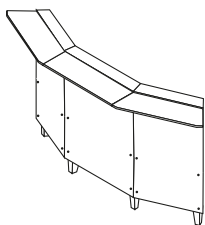

Veneer or Laminate Back

Model No.	Grade / List Price	Grade / List Price							
		1	2/COM	3/COL	4	6	7	L7	L8
N92MTUIN9	Inside 90°, Upholstered Back	\$ 3099	3216	3272	3354	3609	3818	4823	5144
N92MTLIN9	Inside 90°, Laminate Back	3511	3582	3616	3666	3821	3948	4559	4754
N92MTWIN9	Inside 90°, Veneer Back	3511	3582	3616	3666	3821	3948	4559	4754

Dimensions

Width	63½	Seat Height	18½	Back Height	22½	Weight	166
Depth	27	Seat Depth	20½	Back Width	60	Cubic Ft.	57.9
Height	40¼	Seat Width	55				

- Contrasting fabric option – specify X (i.e., N92MTUIN9X); see next page. For list pricing, use your electronic specification tool or contact customer service
- Power grommet option not available
- Soft glide option available for a \$26 list upcharge

**Bistro Table
High Back
Inside 90°
Wedge**

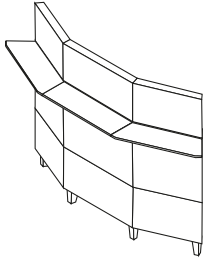

Upholstered Back

Model No.	Grade / List Price	Grade / List Price							
		1	2/COM	3/COL	4	6	7	L7	L8
N92HTUIN9	Inside 90°, Upholstered Back	\$ 3895	4038	4106	4205	4515	4769	5991	6381
N92HTLIN9	Inside 90°, Laminate Back	4719	4818	4865	4934	5149	5325	6172	6443
N92HTWIN9	Inside 90°, Veneer Back	4719	4818	4865	4934	5149	5325	6172	6443

Dimensions

Width	63½	Seat Height	18½	Back Height	35¼	Weight	187
Depth	27	Seat Depth	20½	Back Width	60	Cubic Ft.	73.8
Height	53¼	Seat Width	55				

- Contrasting fabric option – specify X (i.e., N92HTUIN9X); see below. For list pricing, use your electronic specification tool or contact customer service
- Power grommet option not available
- Soft glide option available for a \$26 list upcharge

To Order Contrasting Fabric, Specify:

1. Model Number plus “X”
2. Back Fabric Grade Number/Cover Number
3. Lumbar Fabric Grade Number/Cover Number
4. Seat Fabric Grade Number/Cover Number
5. Accent (headrest) Fabric Grade Number/Cover Number (when applicable)
6. Bistro Table Finish
7. Finish/Laminate (when applicable)
8. Leg Color
9. Glides

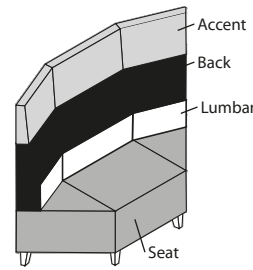

Contrasting Upholstery

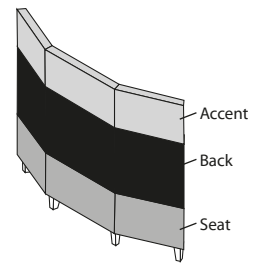

Contrasting Upholstery Back View

Fringe

FRINGE TABLES PRODUCT SPECIFICATIONS

92 Series

FRAME CONSTRUCTION

- Grade A slipmatched cherry or maple veneer or laminate with mitered corner
- Veneer table features National's IntegraClear® environmentally-friendly UV finish in a matte/satin sheen

POWER GROMMET

- Three power grommets available; specify cutout option and order electrical grommet model separately. See pages 463-464 for details and pricing
- Round black plastic grommet available

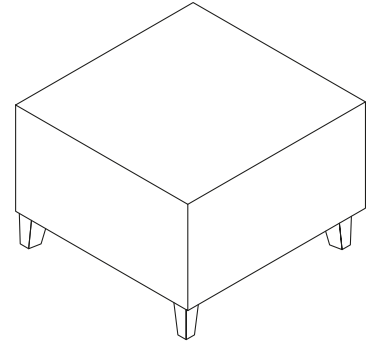

All Fringe models may be ordered to meet TB133 fire code.

To order seating to meet the TB133 fire code, specify an "F" at the end of the model number (Ex: N92M1MF).

Please consult customer service for applicable Arc-Com, COM, Maharam, Momentum, Stinson or Ultrafabrics fabric.



For comprehensive sustainability information that includes LEED® point contribution, visit NationalOfficeFurniture.ecoScorecard.com.

FINISHES

IM Brighton	CW Cordovan
NM Natural	DW Judicial
HN Honey	MH Mocha
CL Caramel	*405 Designer White
TF Truffle	*462 Cinder
AC Autumn	*792 Sable
MC Amber	*793 Acorn

*Not available on wood inline, corner or end tables

LAMINATES

IM Brighton	DW Judicial
NM Natural	MH Mocha
HN2 Honey 2	405 Designer White
CL Caramel	462 Cinder
TF Truffle	**791 Palisander
AC2 Autumn 2	792 Sable
MC Amber	793 Acorn
CW Cordovan	

**791 Palisander laminate coordinates with (NM) Natural, (HN) Honey and (MH) Mocha finishes

GLIDES

STD Standard
C10 Soft (add \$26 list)

METAL LEG/BASE COLORS

462 Cinder
497 Polished Aluminum
501 Platinum Metallic
503 Satin Nickel Metallic

**TABLES
SURFACE GROMMETS/CUTOUTS**

(\$25 list upcharge per location)

G1L	Round Grommet, Left
G1R	Round Grommet, Right
CUT-G17	G17 Cutout
CUT-G23	G23 Cutout
CUT-G17G1L	G17 Cutout & Left Round Grommet
CUT-G17G1R	G17 Cutout & Right Round Grommet
CUT-G23G1L	G23 Cutout & Left Grommet
CUT-G23G1R	G23 Cutout & Right Round Grommet
X	No Grommet

**TABLES
SIDE GROMMETS/CUTOUTS**

(\$25 list upcharge per location)

CUT-G23C	G23 Cutout
X	No Grommet

If specifying cutout, reference pages 463-464 for pricing and details to order power grommet.

**SOLID SURFACE
CORIAN COLORS**

7101	Bisque (Grade A)
7201	Glacier White (Grade B)
7301	Concrete (Grade C)
7302	Deep Night Sky (Grade C)

CORIAN RIM PROFILE



**TOP SHEEN
OPTIONS**

R	Standard
N	Matte/Satin

Inline Table with Grommets/Cutouts

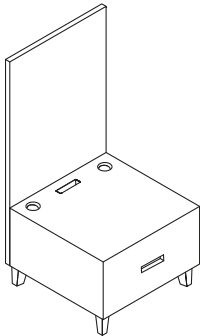

Double Inline Table with Grommets/Cutouts

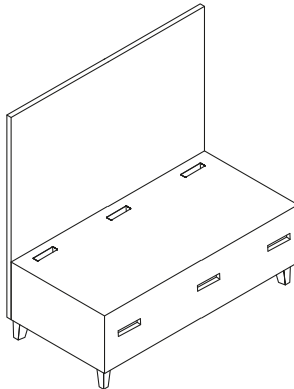

Inline Corner Table with Grommets/Cutouts

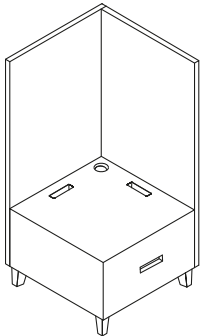

Double Inline Table with Shelf and with Grommets/Cutouts

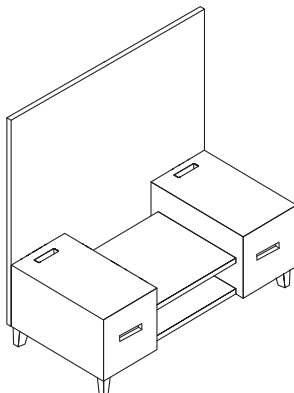

Center surface grommet not available on Media Table

Fringe

To Order, Specify:

1. Model Number
2. Surface Grommet
3. Side Grommet
4. Wood/Laminate Finish
5. Leg Color
6. Glides

- See page 149 for Fringe options

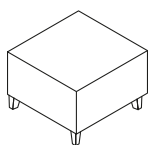
End Table**Model No.****List Price**

Model No.	Material	List Price
N92TENW	Wood, Metal Legs	\$ 1460
N92TENWW	Wood, Wood Legs	1588
N92TENL	Laminate, Metal Legs	1327
N92TENLW	Laminate, Wood Legs	1455

Dimensions

Width	26½	Weight	61
Depth	26½	Cubic Ft.	13.5
Height	19½		

- \$25 list upcharge per grommet or cutout location
- Power grommet is sold separately; Reference pages 463-464 for pricing and details
- Power grommet cutout is always center
- Soft glide option available for a \$26 list upcharge

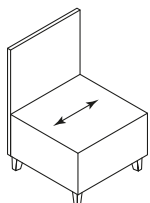
Mid Back Inline Table

N92TMIBW	Ganging Wood, Metal Legs	\$ 1777
N92TMIBWW	Ganging Wood, Wood Legs	1906
N92TMIBL	Ganging Laminate, Metal Legs	1591
N92TMIBLW	Ganging Laminate, Wood Legs	1720

Dimensions

Width	26½	Weight	97
Depth	26½	Cubic Ft.	14.8
Height	40		

- \$25 list upcharge per grommet or cutout location
- Power grommet is sold separately; Reference pages 463-464 for pricing and details
- Power grommet cutout is always center
- Soft glide option available for a \$26 list upcharge

High Back Inline Table

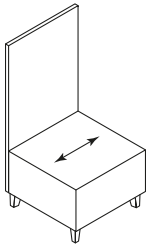

Model No.

List Price

N92THIBW	Ganging Wood, Metal Legs	\$ 1830
N92THIBWW	Ganging Wood, Wood Legs	1959
N92THIBL	Ganging Laminate, Metal Legs	1645
N92THIBLW	Ganging Laminate, Wood Legs	1774

Dimensions

Width	26½
Depth	26½
Height	53

Weight	109
Cubic Ft.	15.4

- \$25 list upcharge per grommet or cutout location
- Power grommet is sold separately; Reference pages 463-464 for pricing and details
- Power grommet cutout is always center
- Soft glide option available for a \$26 list upcharge

Mid Back Inline Corner Table

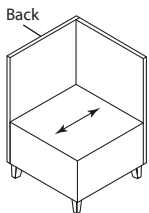

Left

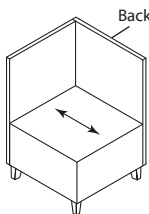

Right

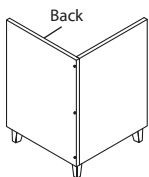

Mid Back Corner Table
Back View - Right

N92TMCLW	Left Corner Wood, Metal Legs	\$ 2095
N92TMCLWW	Left Corner Wood, Wood Legs	2224
N92TMCLL	Left Corner Laminate, Metal Legs	1857
N92TMCLLW	Left Corner Laminate, Wood Legs	1986
N92TMCRW	Right Corner Wood, Metal Legs	2095
N92TMCRWW	Right Corner Wood, Wood Legs	2224
N92TMCR L	Right Corner Laminate, Metal Legs	1857
N92TMCR LW	Right Corner Laminate, Wood Legs	1986

Dimensions

Width	26½
Depth	26½
Height	40

Weight	130
Cubic Ft.	15.0

- \$25 list upcharge per grommet or cutout location
- Power grommet is sold separately; Reference pages 463-464 for pricing and details
- Power grommet cutout is always center
- When specifying Cinder as the leg color, decorative fasteners will be black
- When specifying Polished Aluminum, Platinum Metallic, or Satin Nickel Metallic as the leg color, decorative fasteners will be Polished Aluminum
- Soft glide option available for a \$26 list upcharge

Fringe

To Order, Specify:

1. Model Number
 2. Surface Grommet
 3. Side Grommet
 4. Wood/Laminate Finish
 5. Leg Color
 6. Glides
- See page 149 for Fringe options

High Back Inline Corner Table

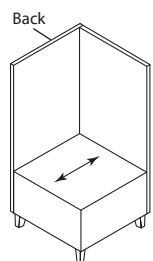

Left

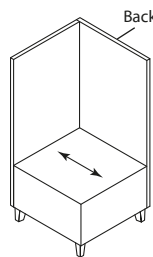

Right

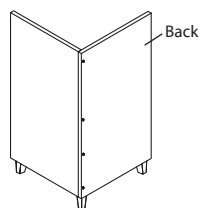

High Back Corner Table
Back View - Left

Model No.		List Price
-----------	--	------------

N92THCLW	Left Corner Wood, Metal Legs	\$ 2201
N92THCLWW	Left Corner Wood, Wood Legs	2330
N92THCCLL	Left Corner Laminate, Metal Legs	1963
N92THCCLW	Left Corner Laminate, Wood Legs	2092
N92THCRW	Right Corner Wood, Metal Legs	2201
N92THCRWW	Right Corner Wood, Wood Legs	2330
N92THCRL	Right Corner Laminate, Metal Legs	1963
N92THCRLW	Right Corner Laminate, Wood Legs	2092

Dimensions

Width	26½	Weight	152
Depth	26½	Cubic Ft.	15.0
Height	53		

- \$25 list upcharge per grommet or cutout location
- Power grommet is sold separately; Reference pages 463-464 for pricing and details
- Power grommet cutout is always center
- When specifying Cinder as the leg color, decorative fasteners will be black
- When specifying Polished Aluminum, Platinum Metallic, or Satin Nickel Metallic as the leg color, decorative fasteners will be Polished Aluminum
- Soft glide option available for a \$26 list upcharge

**Mid Back
Double Inline Table**

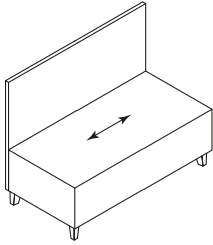

Model No. List Price

Laminate

N92TMIB18L	18" Depth, Metal Legs	\$ 2971
N92TMIB18LW	18" Depth, Wood Legs	3099
N92TMIB27L	27" Depth, Metal Legs	3183
N92TMIB27LW	27" Depth, Wood Legs	3311

Veneer

N92TMIB18W	18" Depth, Metal Legs	\$ 3342
N92TMIB18WW	18" Depth, Wood Legs	3471
N92TMIB27W	27" Depth, Metal Legs	3555
N92TMIB27WW	27" Depth, Wood Legs	3683

Dimensions

Width	53	18" Weight	142
Depth	18 or 27	18" Cubic Ft.	16.9
Height	40	27" Weight	161
		27" Cubic Ft.	23.6

- \$25 list upcharge per grommet or cutout location
- Power grommet is sold separately; Reference pages 463-464 for pricing and details
- Power grommet cutout is always center
- Soft glide option available for a \$26 list upcharge

**High Back
Double Inline Table**

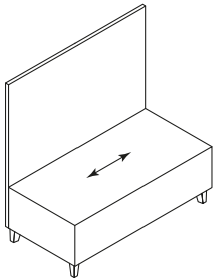

Laminate

N92THIB18L	18" Depth, Metal Legs	\$ 3077
N92THIB18LW	18" Depth, Wood Legs	3205
N92THIB27L	27" Depth, Metal Legs	3289
N92THIB27LW	27" Depth, Wood Legs	3418

Veneer

N92THIB18W	18" Depth, Metal Legs	\$ 3342
N92THIB18WW	18" Depth, Wood Legs	3471
N92THIB27W	27" Depth, Metal Legs	3555
N92THIB27WW	27" Depth, Wood Legs	3683

Dimensions

Width	53	18" Weight	168
Depth	18 or 27	18" Cubic Ft.	16.9
Height	53	27" Weight	185
		27" Cubic Ft.	23.6

- \$25 list upcharge per grommet or cutout location
- Power grommet is sold separately; Reference pages 463-464 for pricing and details
- Power grommet cutout is always center
- Soft glide option available for a \$26 list upcharge

Fringe

To Order, Specify:

1. Model Number
2. Surface Grommet
3. Side Grommet
4. Wood/Laminate Finish
5. Leg Color
6. Glides

• See page 149 for Fringe options

To Order Media Tables, Specify:

1. Model Number
2. Surface Grommet
3. Side Grommet
4. Wood/Laminate Finish
5. Leg Color
6. Glides

• See page 149 for Fringe options

Mid Back Double Inline Table with Shelf

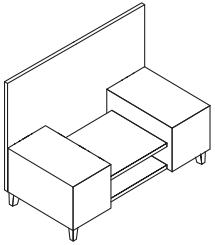

Model No.	List Price
-----------	------------

Laminate

N92TMIBS18L	18" Depth, Metal Legs	\$ 3177
N92TMIBS18LW	18" Depth, Wood Legs	3305
N92TMIBS27L	27" Depth, Metal Legs	3389
N92TMIBS27LW	27" Depth, Wood Legs	3517

Veneer

N92TMIBS18W	18" Depth, Metal Legs	\$ 3548
N92TMIBS18WW	18" Depth, Wood Legs	3677
N92TMIBS27W	27" Depth, Metal Legs	3761
N92TMIBS27WW	27" Depth, Wood Legs	3889

Dimensions

Width	53	18" Weight	168
Depth	18 or 27	18" Cubic Ft.	16.9
Height	40	27" Weight	185
		27" Cubic Ft.	23.6

- \$25 list upcharge per grommet or cutout location
- Power grommet is sold separately; Reference pages 463-464 for pricing and details
- Power grommet cutout is always center
- Soft glide option available for a \$26 list upcharge

**High Back
Double Inline Table
with Shelf**

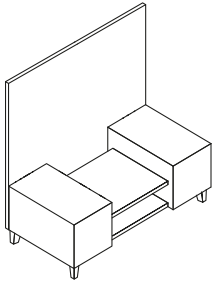

Model No. List Price

Laminate

N92THIBS18L	18" Depth, Metal Legs	\$ 3283
N92THIBS18LW	18" Depth, Wood Legs	3411
N92THIBS27L	27" Depth, Metal Legs	3495
N92THIBS27LW	27" Depth, Wood Legs	3624

Veneer

N92THIBS18W	18" Depth, Metal Legs	\$ 3548
N92THIBS18WW	18" Depth, Wood Legs	3677
N92THIBS27W	27" Depth, Metal Legs	3761
N92THIBS27WW	27" Depth, Wood Legs	3889

Dimensions

Width	53	18" Weight	200
Depth	18 or 27	18" Cubic Ft.	16.9
Height	53	27" Weight	218
		27" Cubic Ft.	23.6

- \$25 list upcharge per grommet or cutout location
- Power grommet is sold separately; Reference pages 463-464 for pricing and details
- Power grommet cutout is always center
- Soft glide option available for a \$26 list upcharge

**High Back
Double Inline
Media Table**

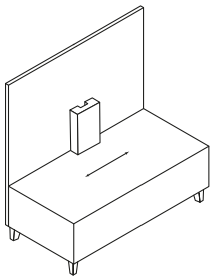

Laminate

N92THIBV18L	18" Depth, Metal Legs	\$ 3386
N92THIBV18LW	18" Depth, Wood Legs	3514
N92THIBV27L	27" Depth, Metal Legs	3598
N92THIBV27LW	27" Depth, Wood Legs	3727

Veneer

N92THIBV18W	18" Depth, Metal Legs	\$ 3757
N92THIBV18WW	18" Depth, Wood Legs	3886
N92THIBV27W	27" Depth, Metal Legs	3970
N92THIBV27WW	27" Depth, Wood Legs	4098

Dimensions

Width	53	18" Weight	168
Depth	18 or 27	18" Cubic Ft.	16.9
Height	40	27" Weight	185
		27" Cubic Ft.	23.6

- Includes TV mounting kit
- Center surface grommet not available
- \$25 list upcharge per grommet or cutout location
- Power grommet is sold separately; Reference pages 463-464 for pricing and details
- Power grommet cutout is always center
- Soft glide option available for a \$26 list upcharge

Fringe

To Order Media Tables, Specify:

1. Model Number
 2. Surface Grommet
 3. Side Grommet
 4. Wood/Laminate Finish
 5. Leg Color
 6. Glides
- See page 149 for Fringe options

To Order Worksurfaces, Specify:

1. Model Number
 2. Wood/Laminate Finish (when applicable)
- See page 149 for Fringe options

High Back Double Inline Media Table with Shelf

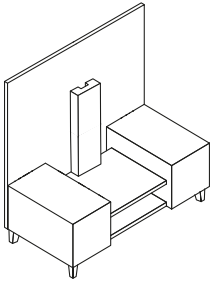

Model No.	List Price
-----------	------------

Laminate

N92THIBVS18L	18" Depth, Metal Legs	\$ 3901
N92THIBVS18LW	18" Depth, Wood Legs	4029
N92THIBVS27L	27" Depth, Metal Legs	4113
N92THIBVS27LW	27" Depth, Wood Legs	4242

Veneer

N92THIBVS18W	18" Depth, Metal Legs	\$ 4272
N92THIBVS18WW	18" Depth, Wood Legs	4401
N92THIBVS27W	27" Depth, Metal Legs	4485
N92THIBVS27WW	27" Depth, Wood Legs	4613

Dimensions

Width	53	18" Weight	200
Depth	18 or 27	18" Cubic Ft.	16.9
Height	53	27" Weight	218
		27" Cubic Ft.	23.6

- Includes TV mounting kit
- \$25 list upcharge per grommet or cutout location
- Power grommet is sold separately; Reference pages 463-464 for pricing and details
- Power grommet cutout is always center
- Soft glide option available for a \$26 list upcharge

Architectural Wall Mount Kit

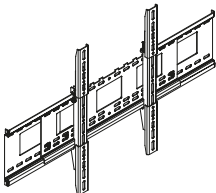

15NTVMAS	Black	\$ 309
-----------------	-------	---------------

Dimensions

Depth	15¾-47¼	Weight	25
Height	15¾-31¼	Cubic Ft.	2.0

- Adjustable Universal Wall Mount adjusts to allow installation of most 32" to 80" flat panel
- Black powder coat

Set-On Rectangle Worksurface Softened Edge

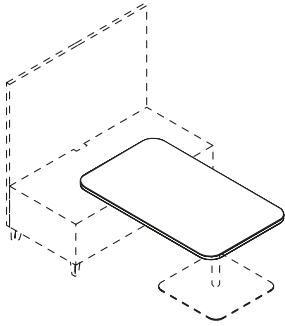

Model No.		Grade / List Price		
30" x 60"				
N92TRT3060W	Wood	\$ 1298	62 lbs.	3.6
N92TRT3060L	Laminate	865	62 lbs.	3.6
30" x 84"				
N92TRT3084W	Wood	\$ 1471	90 lbs.	5.2
N92TRT3084L	Laminate	1038	90 lbs.	5.2

- Recommended for use with Fringe double inline or double inline media tables
- Attachment hardware included
- Requires one leveling disk base
- Inline table surface will be defaced when worksurface is attached
- 60" table works with two seat lounge
- 84" table works with three seat lounge

Set-On Rectangle Worksurface Knife Edge

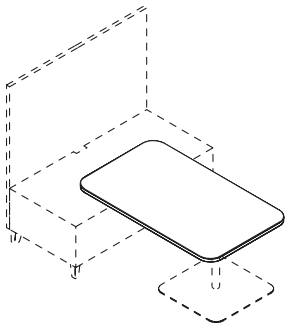

30" x 60"				
N92TRT3060WK	Wood	\$ 1607	76 lbs.	4.4
N92TRT3060LK	Laminate	1174	76 lbs.	4.4
30" x 84"				
N92TRT3084WK	Wood	\$ 1903	104 lbs.	5.8
N92TRT3084LK	Laminate	1298	104 lbs.	5.8

- Recommended for use with Fringe double inline or double inline media tables
- Attachment hardware included
- Requires one leveling disk base
- Inline table surface will be defaced when worksurface is attached
- 60" table works with two seat lounge
- 84" table works with three seat lounge

Set-On Rectangle Worksurface Solid Surface

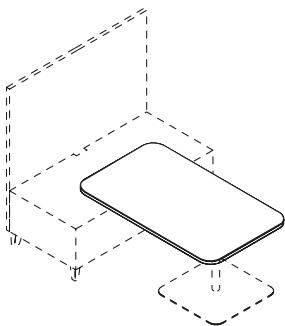

30" x 60"		Grade A	Grade B	Grade C		
N92TRT3060S	Corian Solid Surface	\$ 2946	3104	3316	65 lbs.	6.6
30" x 84"						
N92TRT3084S	Corian Solid Surface	\$ 3819	4037	4329	88 lbs.	9.1

- Recommended for use with Fringe double inline or double inline media tables
- Attachment hardware included
- Requires one leveling disk base
- Inline table surface will be defaced when worksurface is attached
- 60" table works with two seat lounge
- 84" table works with three seat lounge

Fringe

To Order, Specify:

- 1. Model Number
- See page 149 for Fringe options

**Round Leveling
Disc Base
Collaborative Height**

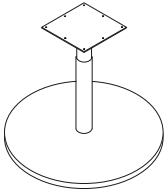

Model No.		List Price	Cartoned Weight	Cubic Feet
CBV2219DLB	Cinder	\$ 676	50 lbs.	2.6
CBV2219DLS	Platinum Metallic	676	50 lbs.	2.6
CBV2219DLN	Satin Nickel Metallic	676	50 lbs.	2.6

Dimensions

Width 22
Diameter 3
Height 19-20½

- Not to be used in freestanding table application

**Square Leveling
Disc Base
Collaborative Height**

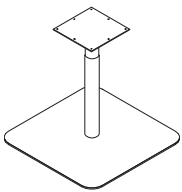

CBV2219SQDLB	Cinder	\$ 779	50 lbs.	2.6
CBV2219SQDLS	Platinum Metallic	779	50 lbs.	2.6
CBV2219SQDLN	Satin Nickel Metallic	779	50 lbs.	2.6

Dimensions

Width 22
Diameter 3
Height 19-20½

- Not to be used in freestanding table application

Freestanding Rectangle Worksurface Softened Edge



Model No.		List Price	Cartoned Weight	Cubic Feet
30" x 48"				
N92TRT3048W	Wood	\$ 1128	67 lbs.	2.8
N92TRT3048L	Laminate	752	67 lbs.	2.8
30" x 72"				
N92TRT3072W	Wood	\$ 1409	95 lbs.	4.0
N92TRT3072L	Laminate	939	95 lbs.	4.0

- Requires two bases
- 48" table works with two seat lounge
- 72" table works with three seat lounge

Freestanding Rectangle Worksurface Knife Edge

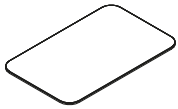

30" x 48"				
N92TRT3048WK	Wood	\$ 1375	67 lbs.	2.8
N92TRT3048LK	Laminate	917	67 lbs.	2.8
30" x 72"				
N92TRT3072WK	Wood	\$ 1743	95 lbs.	4.0
N92TRT3072LK	Laminate	1162	95 lbs.	4.0

- Requires two bases
- 48" table works with two seat lounge
- 72" table works with three seat lounge

Freestanding Rectangle Worksurface



Model No.		Grade A	Grade B	Grade C		
30" x 48"						
N92TRT3048S	Corian Solid Surface	\$ 2524	2654	2826	52 lbs.	5.4
30" x 72"						
N92TRT3072S	Corian Solid Surface	\$ 3394	3584	3836	78 lbs.	7.9

- Requires two bases
- 48" table works with two seat lounge
- 72" table works with three seat lounge

Fringe

To Order, Specify:

1. Model Number
- See page 149 for Fringe options

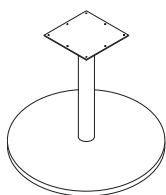
Round Disc Base

Model No.		List Price	Cartoned Weight	Cubic Feet
CBV2219DB	Cinder	\$ 643	45 lbs.	2.3
CBV2219DS	Platinum Metallic	643	45 lbs.	2.3
CBV2219DN	Satin Nickel Metallic	643	45 lbs.	2.3

Dimensions

Width	22
Diameter	3
Height	19½

- Not to be used in set-on table application

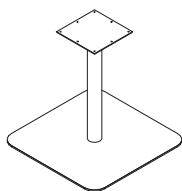
Square Disc Base

CBV2219SQB	Cinder	\$ 724	45 lbs.	2.3
CBV2219SQS	Platinum Metallic	724	45 lbs.	2.3
CBV2219SQN	Satin Nickel Metallic	724	45 lbs.	2.3

Dimensions

Width	22
Diameter	3
Height	19½

- Not to be used in set-on table application

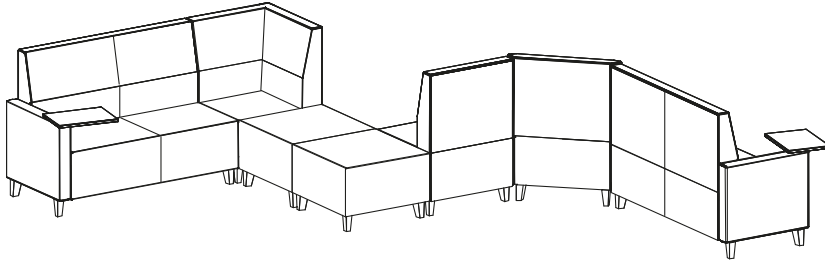

Model No.	Quantity	Description	Grade 1 List Price
N92B1	(2)	Single Seat Bench	\$ 1241 ea
N92M2RR	(2)	Mid Back Two Seat Right Arm With Tablet	2753 ea
N92M1M	(1)	Mid Back Single Seat Armless	1559
N92MSQ9D	(1)	Mid Back Square 90° Corner	2037
N92MOU9	(1)	Mid Back Outside 90° Wedge	2275
Total			\$ 13,859

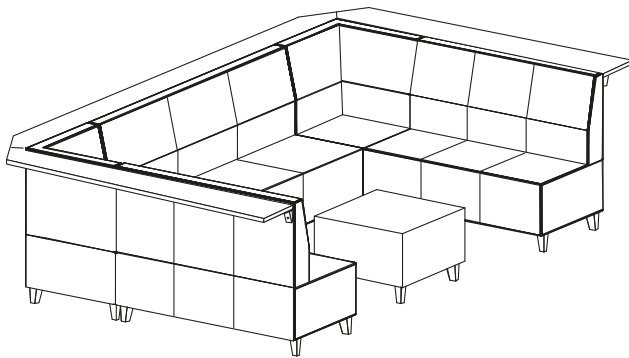

N92MTU3M	(3)	Bistro Table Mid Back 3 Seat upholstered Back	\$ 4265 ea
N92MTUSQ9R	(2)	Bistro Table Mid Back Square 90° Corner	2861 ea
N92TENL	(1)	End Table Laminate	1327
Total			\$ 19,844

Fringe

Fringe

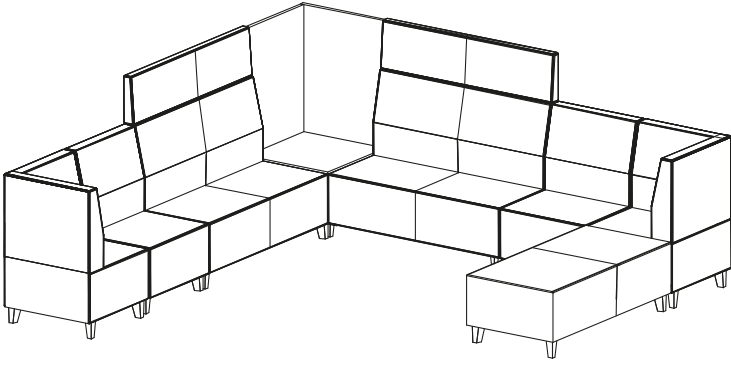

Model No.	Quantity	Description	Grade 1 List Price
N92MSQ9D	(2)	Mid Back Square 90° Corner	\$ 2037 ea
N92M1M	(2)	Mid Back Single Seat Armless	1559 ea
N92H2M	(2)	High Back Two Seat Armless	3336 ea
N92THCLL	(1)	High Back Inline Corner Table Laminate (Right Or Left)	1963
N92B2	(1)	Two Seat Bench	1639
Total			\$ 17,466

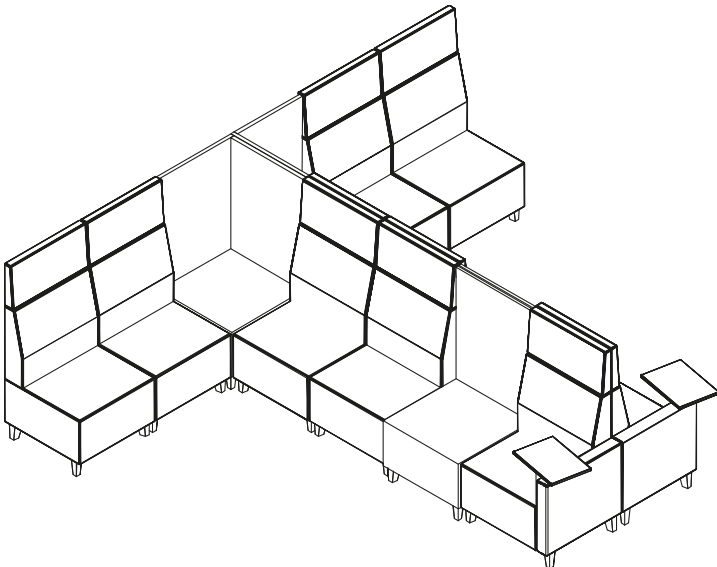

N92H2M	(4)	High Back Two Seat Armless	\$ 3336 ea
N92H1RR	(1)	High Back Single Seat Right Arm With Tablet	2568
N92H1LL	(1)	High Back Single Seat Left Arm With Tablet	2568
N92THCRL	(1)	High Back Inline Corner Table Right Laminate	1963
N92THCLL	(1)	High Back Inline Corner Table Left Laminate	1963
N92THIBL	(2)	High Back Inline Table Laminate	1645 ea
Total			\$ 25,696

Fuel[®]

FUEL PRODUCT SPECIFICATIONS

35 Series

SEAT CONSTRUCTION

- 2½" of high grade polyurethane foam covers a solid contoured molded plywood seat panel for support and comfort

BACK CONSTRUCTION

- Injection molded polypropylene outer shell
- Blow molded polyethylene inner back shell designed with deep ribbing to provide extra support
- Backs feature 2½" of custom molded, controlled density polyurethane foam for consistency and good contoured support on all models
- Large and tall models feature solid molded plywood panels

BACK REST

- Back height can be adjusted by simply lifting up on the back
- The range of adjustment is approximately 2"

ARMS

- Height adjustable arms have encased uprights made of reinforced nylon
- Height adjustable arms adjust in height with a push button to one of five positions within a 2½" range
- Arms with pivot function allow arm pad rotation to three different positions for better ergonomic use
- Arms with width adjustment allow arms to adjust within a 2" range
- Arm pads are soft polyurethane
- Loop arms have encased high strength steel uprights made of polyurethane
- High performance arms have arm pads that adjust in depth, width, and pivot
- High performance arms are available either with arm height adjustment or arm height and width adjustment

CONTROL MECHANISM—KNEE TILT

- The standard knee tilt mechanism features a heavy-duty adjustment tension spring for a variety of body sizes and minimal rise of front seat edge; this allows the users feet to remain planted when the chair is in the reclining position
- The combination gas lift/tilt lock lever allows dual functions with a simple in/out movement for lockout and an up/down movement for height adjustment
- Standard pneumatic gas cylinder lift allows seat to raise and lower 4" and provides spring action for added comfort
- Seatslide option adjusts seat depth to seven different positions within a 2½" range

CONTROL MECHANISM—SYNCHRONOUS

- Synchronous control allows the back and seat to move in a synchronized 2.3:1 ratio motion
- Free float feature allows the chair to tilt freely
- A side activated telescoping tension adjustment handle provides a comfortable way to adjust back tension to meet individual needs
- The back angle can be locked in one of five positions
- Standard pneumatic gas cylinder lift allows seat to raise and lower 4¼" and provides spring action for added comfort
- Seatslide option adjusts seat depth within a 2½" range
- Low back models feature the option of the standard pneumatic cylinder, which allows the seat to raise and lower 4¼", or a lower height pneumatic cylinder, which allows the seat to raise and lower 3"

CONTROL MECHANISM—LARGE AND TALL MODELS

- Synchronous control allows the back and seat to move in a synchronized 2:1 ratio motion
- Free float feature allows the chair to tilt freely or be locked in the neutral position
- To maintain proper tension and stability, the synchronous control is recommended for individuals weighing less than 425 lbs.
- Standard pneumatic gas cylinder lift allows seat to raise and lower 4¼" and provides spring action for added comfort

BASE AND CASTERS

- Black, five-prong fiberglass reinforced nylon base ensures long life
- Hard, double wheel casters, which work on multiple surfaces, are standard
- Soft, double wheel casters, for use on hard floors, are available at an upcharge
- All National bases are tested to BIFMA standards using 2500 lbs. of force

LARGE AND TALL AND INTENSIVE USE MODELS

- Intensive use models meet the Federal Intensive Usage Standard FED-STD 834
- Large and tall models support up to 425 lbs.
- Feature a black, 27" five-prong aluminum base tested using 4500 lbs. of force
- Hard, double wheel casters, which work on multiple surfaces, are standard

QUICK DELIVERY PROGRAM

- All Fuel models available on Quick Delivery, including TB133

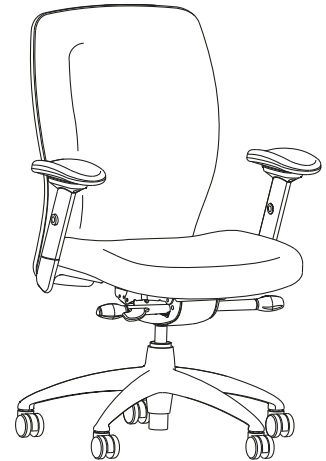

All Fuel models may be ordered to meet TB133 fire code.

To order seating to meet the TB133 fire code, specify an "F" at the end of the model number (Ex: N35BACF).

Reference pages 465-493 for TB133 Fabric Matrix and pricing.

Please consult customer service for applicable Arc-Com, COM, Maharam, Momentum, Stinson or Ultrafabrics fabric.



For comprehensive sustainability information that includes LEED® point contribution, visit NationalOfficeFurniture.ecoScorecard.com.

FABRICS

- Grade 1 American Graffiti**
- Cali
- Plush**
- Ridge**
- Speedway
- Stardust
- Grade 2 Cathedral**
- COM
- Orbit
- Pixie**
- Sedona**
- Shenanigans
- Spectrum**
- *Strand
- Tranquility
- Twilight

- Grade 3 Boardwalk
- COL
- Jacks**
- Pop Rocks**
- Grade 4 Big City**
- Bumble**
- Connect Four**
- Echo**
- Silvertex**
- Grade 6 Essence/Ultraleather**
- Flock
- Scribe**

- Grade 7 Brisa**
- Brisa Distressed**
- Promessa**
- Silica**
- Grade L7 Davenport**
- Grade L8 Showcase**

*Strand restricted on upholstered back models
 **These fabrics meet the FED-STD 834 requirements

FINISHES

Standard Black

PNEUMATIC CYLINDER HEIGHT

- STD Standard
- LS Lower Seat Height (low back only)

CASTERS

- C1 Hard (standard)
- C2 Soft (add \$24 list)

To You In 10 DAYS ...or Less
 Shaded model numbers are available on our "To You in 10 Days or Less" Quick Delivery program and will be delivered within 10 days.

To Order, Specify:

1. Model Number
2. Fabric Grade Number
3. Cover Number
4. Pneumatic Cylinder Height
5. Casters

• See page 205 for Fuel options

**Low Back
 Armless
 Synchronous**

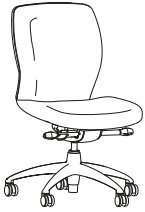

Model No. Grade / List Price

Quick Delivery Models: QN35CAC, QN35CBC

		1	2/COM	3/COL	4	6	7	L7	L8
N35CAC	Plastic Back	\$ 728	749	759	773	818	855	1032	1089
N35CBC	Upholstered Back	757	792	808	832	907	969	1264	1359

Dimensions

Width	26	Seat Height (STD)	17¼-21¾	Seat Depth	17	Weight	42
Depth	24	Seat Height (LS)	15¼-18¼	Back Height	17¼-19¼	Cubic Ft.	18.3
Height (STD)	32¾-40½	Seat Width	20¼	Back Width	18		
Height (LS)	30¾-37						

**Low Back
 Height Adjustable Arm
 Synchronous**



Quick Delivery Models: QN35CCC, QN35CEC

		1	2/COM	3/COL	4	6	7	L7	L8
N35CCC	Plastic Back	\$ 871	892	902	916	961	998	1175	1232
N35CEC	Upholstered Back	902	937	953	977	1052	1114	1409	1504

Dimensions

Width	27	Arm Height (STD)	25-32	Seat Depth	17	Weight	47
Depth	24	Arm Height (LS)	23¼-28½	Back Height	17¼-19¼	Cubic Ft.	18.3
Height (STD)	32¾-40½	Arm Width	17½	Back Width	18		
Height (LS)	30¾-37	Seat Height (STD)	17¼-21¾				
		Seat Height (LS)	15¼-18¼				
		Seat Width	20¼				



Height Adjustable Arm

**Low Back
Height/Pivot Arm
Synchronous**



Height/Pivot Arm

**Model
No.** **Grade / List Price**

Quick Delivery Models: QN35CJC, QN35CMC

		1	2/COM	3/COL	4	6	7	L7	L8
N35CJC	Plastic Back	\$ 952	973	983	997	1042	1079	1256	1313
N35CMC	Upholstered Back	983	1018	1034	1058	1133	1195	1490	1585

Dimensions

Width	27	Arm Height (STD)	26-32 $\frac{3}{4}$	Seat Depth	17	Weight	48
Depth	24	Arm Height (LS)	24-29 $\frac{1}{2}$	Back Height	17 $\frac{1}{4}$ -19 $\frac{1}{4}$	Cubic Ft.	18.3
Height (STD)	32 $\frac{3}{4}$ -40 $\frac{1}{2}$	Arm Width	17 $\frac{1}{4}$ -19 $\frac{1}{2}$	Back Width	18		
Height (LS)	30 $\frac{3}{4}$ -37	Seat Height (STD)	17 $\frac{1}{4}$ -21 $\frac{3}{4}$				
		Seat Height (LS)	15 $\frac{1}{4}$ -18 $\frac{1}{4}$				
		Seat Width	20 $\frac{1}{4}$				

**Low Back
Height/Width Arm
Synchronous**



Height/Width Arm

Quick Delivery Models: QN35COC, QN35CPC

		1	2/COM	3/COL	4	6	7	L7	L8
N35COC	Plastic Back	\$ 969	990	1000	1014	1059	1096	1273	1330
N35CPC	Upholstered Back	998	1033	1049	1073	1148	1210	1505	1600

Dimensions

Width	26-27 $\frac{1}{2}$	Arm Height (STD)	25-32	Seat Depth	17	Weight	48
Depth	24	Arm Height (LS)	23 $\frac{1}{4}$ -28 $\frac{1}{2}$	Back Height	17 $\frac{1}{4}$ -19 $\frac{1}{4}$	Cubic Ft.	18.3
Height (STD)	32 $\frac{3}{4}$ -40 $\frac{1}{2}$	Arm Width	17 $\frac{1}{4}$ -19 $\frac{1}{2}$	Back Width	18		
Height (LS)	30 $\frac{3}{4}$ -37	Seat Height (STD)	17 $\frac{1}{4}$ -21 $\frac{3}{4}$				
		Seat Height (LS)	15 $\frac{1}{4}$ -18 $\frac{1}{4}$				
		Seat Width	20 $\frac{1}{4}$				

**Low Back
Height/Width/Pivot Arm
Synchronous**



Height/Width/Pivot Arm

Quick Delivery Models: QN35CSC, QN35CTC

		1	2/COM	3/COL	4	6	7	L7	L8
N35CSC	Plastic Back	\$ 993	1014	1024	1038	1083	1120	1297	1354
N35CTC	Upholstered Back	1023	1058	1074	1098	1173	1235	1530	1625

Dimensions

Width	26-29 $\frac{1}{2}$	Arm Height (STD)	26-32 $\frac{3}{4}$	Seat Depth	17	Weight	49
Depth	24	Arm Height (LS)	24-29 $\frac{1}{2}$	Back Height	17 $\frac{1}{4}$ -19 $\frac{1}{4}$	Cubic Ft.	18.3
Height (STD)	32 $\frac{3}{4}$ -40 $\frac{1}{2}$	Arm Width	17 $\frac{1}{4}$ -19 $\frac{1}{2}$	Back Width	18		
Height (LS)	30 $\frac{3}{4}$ -37	Seat Height (STD)	17 $\frac{1}{4}$ -21 $\frac{3}{4}$				
		Seat Height (LS)	15 $\frac{1}{4}$ -18 $\frac{1}{4}$				
		Seat Width	20 $\frac{1}{4}$				

To You In 10 DAYS ...or Less Shaded model numbers are available on our "To You in 10 Days or Less" Quick Delivery program and will be delivered within 10 days.

To Order, Specify:

1. Model Number
2. Fabric Grade Number
3. Cover Number
4. Pneumatic Cylinder Height
5. Casters

• See page 205 for Fuel options

Low Back High Performance Height Adjustment Arm Synchronous

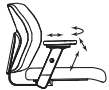

High Performance Height Adjustment Arm

Model No. Grade / List Price

Quick Delivery Models: QN35CCCD, QN35CECD

		1	2/COM	3/COL	4	6	7	L7	L8
N35CCCD	Plastic Back	\$ 984	1005	1015	1029	1074	1111	1288	1345
N35CECD	Upholstered Back	1015	1050	1066	1090	1165	1227	1522	1617

Dimensions

Width	27	Arm Height (STD)	26-33	Seat Depth	17	Weight	47
Depth	24	Arm Height (LS)	24¼-29½	Back Height	17¼-19¼	Cubic Ft.	18.3
Height (STD)	32¾-40½	Arm Width	17¼-19½	Back Width	18		
Height (LS)	30¾-37	Seat Height (STD)	17¼-21¾				
		Seat Height (LS)	15¼-18¼				
		Seat Width	20¼				

Low Back High Performance Height/Width Adjustment Arm Synchronous



High Performance Height/Width Adjustment Arm

Quick Delivery Models: QN35COCD, QN35CPCD

		1	2/COM	3/COL	4	6	7	L7	L8
N35COCD	Plastic Back,	\$ 1083	1104	1114	1128	1173	1210	1387	1444
N35CPCD	Upholstered Back	1111	1146	1162	1186	1261	1323	1618	1713

Dimensions

Width	27	Arm Height (STD)	26-33	Seat Depth	17	Weight	47
Depth	24	Arm Height (LS)	24-29½	Back Height	17¼-19¼	Cubic Ft.	18.3
Height (STD)	32¾-40½	Arm Width	17¼-19¼	Back Width	18		
Height (LS)	30¾-37	Seat Height (STD)	17¼-21¾				
		Seat Height (LS)	15¼-18¼				
		Seat Width	20¼				

Mid Back
Armless
Knee Tilt



Model No. Grade / List Price

Quick Delivery Models: QN35BAC, QN35BACS, QN35BBC, QN35BBCS

		1	2/COM	3/COL	4	6	7	L7	L8
N35BAC	Plastic Back	\$ 644	667	678	694	744	785	982	1045
N35BACS	Plastic Back/Seatslide	741	764	775	791	841	882	1079	1142
N35BBC	Upholstered Back	675	714	733	760	845	915	1250	1357
N35BBCS	Upholstered Back/Seatslide	770	809	828	855	940	1010	1345	1452

Dimensions

Width	26½	Seat Height	17¼-21	Seat Depth	17¾	Weight	43
Depth	26½	Seat Height with Seatslide	18-21¾	Seat Depth with Seatslide	17½-19½	Weight with Seatslide	46
Depth with Seatslide	26¼-28½	Seat Width	20¼	Back Height	22½-24½	Cubic Ft.	20.4
Height	37½-45			Back Width	19		

Mid Back
Height Adjustable Arm
Knee Tilt



Height Adjustable Arm

Quick Delivery Models: QN35BCC, QN35BCCS, QN35BEC, QN35BECS

		1	2/COM	3/COL	4	6	7	L7	L8
N35BCC	Plastic Back	\$ 788	811	822	838	888	929	1126	1189
N35BCCS	Plastic Back/Seatslide	884	907	918	934	984	1025	1222	1285
N35BEC	Upholstered Back	817	856	875	902	987	1057	1392	1499
N35BECS	Upholstered Back/Seatslide	914	953	972	999	1084	1154	1489	1596

Dimensions

Width	27	Arm Height	23½-30½	Seat Depth	17¾	Weight	48
Depth	26½	Arm Width	17½	Seat Depth with Seatslide	17½-19½	Weight with Seatslide	51
Depth with Seatslide	26½-28½	Seat Height	17¼-21	Back Height	22½-24½	Cubic Ft.	20.4
Height	37½-45	Seat Height with Seatslide	18-21¾	Back Width	19		
		Seat Width	20¼				

Mid Back
Height/Pivot Arm
Knee Tilt



Height/Pivot Arm

Quick Delivery Models: QN35BJC, QN35BJCS, QN35BMC, QN35BMCS

		1	2/COM	3/COL	4	6	7	L7	L8
N35BJC	Plastic Back	\$ 869	892	903	919	969	1010	1207	1270
N35BJCS	Plastic Back/Seatslide	966	989	1000	1016	1066	1107	1304	1367
N35BMC	Upholstered Back	899	938	957	984	1069	1139	1474	1581
N35BMCS	Upholstered Back/Seatslide	995	1034	1053	1080	1165	1235	1570	1677

Dimensions

Width	27	Arm Height	23½-30½	Seat Depth	17¾	Weight	49
Depth	26½	Arm Width	17¼-19½	Seat Depth with Seatslide	17½-19½	Weight with Seatslide	52
Depth with Seatslide	26¼-28½	Seat Height	17½-21	Back Height	22½-24½	Cubic Ft.	20.4
Height	37½-45	Seat Height with Seatslide	18-21¾	Back Width	19		
		Seat Width	20¼				

To You In 10 DAYS ...or Less
 Shaded model numbers are available on our "To You in 10 Days or Less" Quick Delivery program and will be delivered within 10 days.

To Order, Specify:

1. Model Number
 2. Fabric Grade Number
 3. Cover Number
 4. Pneumatic Cylinder Height
 5. Casters
- See page 205 for Fuel options

Mid Back Height/Width Arm Knee Tilt



Height/Width Arm

Model No. Grade / List Price

Quick Delivery Models: QN35BOC, QN35BOCS, QN35BPC, QN35BPCS

		1	2/COM	3/COL	4	6	7	L7	L8
N35BOC	Plastic Back	\$ 878	903	915	933	988	1033	1250	1319
N35BOCS	Plastic Back/Seatslide	974	999	1011	1029	1084	1129	1346	1415
N35BPC	Upholstered Back	906	945	964	991	1076	1146	1481	1588
N35BPCS	Upholstered Back/Seatslide	1002	1041	1060	1087	1172	1242	1577	1684

Dimensions

Width	26-27½	Arm Height	23½-30½	Seat Depth	17½	Weight	49
Depth	26½	Arm Width	17¼-19½	Seat Depth with		Weight with	
Depth with		Seat Height	17½-21	Seatslide	17-20	Seatslide	52
Seatslide	26¼-28½	Seat Height with		Back Height	22½-24½	Cubic Ft.	20.4
Height	37½-45	Seatslide	18-21¾	Back Width	19		
		Seat Width	20¼				

Mid Back Height/Width/Pivot Arm Knee Tilt



Height/Width/Pivot Arm

Quick Delivery Models: QN35BSC, QN35BSCS, QN35BTC, QN35BTCS

		1	2/COM	3/COL	4	6	7	L7	L8
N35BSC	Plastic Back	\$ 895	920	932	950	1005	1050	1267	1336
N35BSCS	Plastic Back/Seatslide	996	1021	1033	1051	1106	1151	1368	1437
N35BTC	Upholstered Back	929	968	987	1014	1099	1169	1504	1611
N35BTCS	Upholstered Back/Seatslide	1024	1063	1082	1109	1194	1264	1599	1706

Dimensions

Width	26-29½	Arm Height	23½-30½	Seat Depth	17¾	Weight	50
Depth	26½	Arm Width	17¼-19½	Seat Depth with		Weight with	
Depth with		Seat Height	17¼-21	Seatslide	17½-19½	Seatslide	53
Seatslide	26¼-28½	Seat Height with		Back Height	22½-24½	Cubic Ft.	20.4
Height	37½-45	Seatslide	18-21¾	Back Width	19		
		Seat Width	20¼				

**Mid Back
High Performance
Height Adjustment Arm
Knee Tilt**

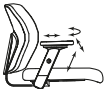

High Performance
Height Adjustment Arm

**Model
No. Grade / List Price**

Quick Delivery Models: QN35BCCD, QN35BCCDS, QN35BECD, QN35BECDs

		1	2/COM	3/COL	4	6	7	L7	L8
N35BCCD	Plastic Back	\$ 900	923	934	950	1000	1041	1238	1301
N35BCCDS	Plastic Back/Seatslide	996	1019	1030	1046	1096	1137	1334	1397
N35BECD	Upholstered Back	930	969	988	1015	1100	1170	1505	1612
N35BECDs	Upholstered Back/Seatslide	1026	1065	1084	1111	1196	1266	1601	1708

Dimensions

Width	26-27½	Arm Height	24½-31½	Seat Depth	17¾	Weight	50
Depth	26½	Arm Width	17½	Seat Depth with Seatslide	17½-19½	Weight with Seatslide	53
Depth with Seatslide	26½-28½	Seat Height	17½-21	Back Height	22½-24½	Cubic Ft.	20.4
Height	37½-45	Seat Height with Seatslide	18-21¾	Back Width	19		
		Seat Width	20¼				

**Mid Back
High Performance
Height/Width Adjustment
Arm
Knee Tilt**



High Performance
Height/Width Adjustment Arm

Quick Delivery Models: QN35BOCD, QN35BOCDS, QN35BPCD, QN35BPCDS

		1	2/COM	3/COL	4	6	7	L7	L8
N35BOCD	Plastic Back	\$ 990	1015	1027	1045	1100	1145	1362	1431
N35BOCDS	Plastic Back/Seatslide	1087	1112	1124	1142	1197	1242	1459	1528
N35BPCD	Upholstered Back	1019	1058	1077	1104	1189	1259	1594	1701
N35BPCDS	Upholstered Back/Seatslide	1115	1154	1173	1200	1285	1355	1690	1797

Dimensions

Width	26-27½	Arm Height	24½-31½	Seat Depth	17¾	Weight	50
Depth	26½	Arm Width	17¼-19¼	Seat Depth with Seatslide	17½-19½	Weight with Seatslide	53
Depth with Seatslide	26½-28½	Seat Height	17½-21	Back Height	22½-24½	Cubic Ft.	20.4
Height	37½-45	Seat Height with Seatslide	18-21¾	Back Width	19		
		Seat Width	20¼				

To You In 10 DAYS ...or Less
 Shaded model numbers are available on our "To You in 10 Days or Less" Quick Delivery program and will be delivered within 10 days.

To Order, Specify:

1. Model Number
2. Fabric Grade Number
3. Cover Number
4. Pneumatic Cylinder Height
5. Casters

• See page 205 for Fuel options

**Mid Back
 Armless
 Synchronous**



Model No. Grade / List Price

Quick Delivery Models: QN35AAC, QN35AACS, QN35ABC, QN35ABCS

		1	2/COM	3/COL	4	6	7	L7	L8
N35AAC	Plastic Back	\$ 737	760	771	787	837	878	1075	1138
N35AACS	Plastic Back/Seatslide	834	857	868	884	934	975	1172	1235
N35ABC	Upholstered Back	765	804	823	850	935	1005	1340	1447
N35ABCS	Upholstered Back/Seatslide	862	901	920	947	1032	1102	1437	1544

Dimensions

Width	26½	Seat Height	17¼-21¾	Seat Depth	17½	Weight	44
Depth	25	Seat Height with		Seat Depth with		Weight with	
Depth with		Seatslide	18-22½	Seatslide	17-20	Seatslide	47
Seatslide	24½-26½	Seat Width	20¼	Back Height	23-25	Cubic Ft.	20.4
Height	39-46½			Back Width	19		

**Mid Back
 Height Adjustable Arm
 Synchronous**



Quick Delivery Models: QN35ACC, QN35ACCS, QN35AEC, QN35AECS

		1	2/COM	3/COL	4	6	7	L7	L8
N35ACC	Plastic Back	\$ 880	903	914	930	980	1021	1218	1281
N35ACCS	Plastic Back/Seatslide	977	1000	1011	1027	1077	1118	1315	1378
N35AEC	Upholstered Back	909	948	967	994	1079	1149	1484	1591
N35AECS	Upholstered Back/Seatslide	1005	1044	1063	1090	1175	1245	1580	1687

Dimensions

Width	27	Arm Height	25-32	Seat Depth	17½	Weight	49
Depth	25	Arm Width	17½	Seat Depth with		Weight with	
Depth with		Seat Height	17¼-21¾	Seatslide	17-20	Seatslide	52
Seatslide	24½-26½	Seat Height with		Back Height	23-25	Cubic Ft.	20.4
Height	39-46½	Seatslide	18-22½	Back Width	19		
		Seat Width	20¼				



Height Adjustable Arm

**Mid Back
Height/Pivot Arm
Synchronous**



Height/Pivot Arm

**Model
No.** **Grade / List Price**

Quick Delivery Models: QN35AJC, QN35AJCS, QN35AMC, QN35AMCS

		1	2/COM	3/COL	4	6	7	L7	L8
N35AJC	Plastic Back	\$ 962	985	996	1012	1062	1103	1300	1363
N35AJCS	Plastic Back/Seatslide	1058	1081	1092	1108	1158	1199	1396	1459
N35AMC	Upholstered Back	990	1029	1048	1075	1160	1230	1565	1672
N35AMCS	Upholstered Back/Seatslide	1088	1127	1146	1173	1258	1328	1663	1770

Dimensions

Width	27	Arm Height	26-32¾	Seat Depth	17½	Weight	50
Depth	25	Arm Width	17½	Seat Depth with Seatslide	17-20	Weight with Seatslide	53
Depth with Seatslide	24½-26½	Seat Height	17¼-21¾	Back Height	23-25	Cubic Ft.	20.4
Height	39-46½	Seat Height with Seatslide	18-22½	Back Width	19		
		Seat Width	20¼				

**Mid Back
Height/Width Arm
Synchronous**



Height/Width Arm

Quick Delivery Models: QN35AOC, QN35AOCs, QN35APC, QN35APCS

		1	2/COM	3/COL	4	6	7	L7	L8
N35AOC	Plastic Back	\$ 974	999	1011	1029	1084	1129	1346	1415
N35AOCs	Plastic Back/Seatslide	1063	1088	1100	1118	1173	1218	1435	1504
N35APC	Upholstered Back	1002	1041	1060	1087	1172	1242	1577	1684
N35APCS	Upholstered Back/Seatslide	1093	1132	1151	1178	1263	1333	1668	1775

Dimensions

Width	26-27½	Arm Height	25-32	Seat Depth	17½	Weight	50
Depth	25	Arm Width	17¼-19½	Seat Depth with Seatslide	17-20	Weight with Seatslide	53
Depth with Seatslide	24½-26½	Seat Height	17¼-21¾	Back Height	23-25	Cubic Ft.	20.4
Height	39-46½	Seat Height with Seatslide	18-22½	Back Width	19		
		Seat Width	20¼				

**Mid Back
Height/Width/Pivot Arm
Synchronous**



Height/Width/Pivot Arm

Quick Delivery Models: QN35ASC, QN35ASCS, QN35ATC, QN35ATCS

		1	2/COM	3/COL	4	6	7	L7	L8
N35ASC	Plastic Back	\$ 996	1021	1033	1051	1106	1151	1368	1437
N35ASCS	Plastic Back/Seatslide	1087	1112	1124	1142	1197	1242	1459	1528
N35ATC	Upholstered Back	1025	1064	1083	1110	1195	1265	1600	1707
N35ATCS	Upholstered Back/Seatslide	1121	1160	1179	1206	1291	1361	1696	1803

Dimensions

Width	26-29½	Arm Height	26-32¾	Seat Depth	17½	Weight	51
Depth	25	Arm Width	17¼-19½	Seat Depth with Seatslide	17-20	Weight with Seatslide	54
Depth with Seatslide	24½-26½	Seat Height	17¼-21¾	Back Height	23-25	Cubic Ft.	20.4
Height	39-46½	Seat Height with Seatslide	18-22½	Back Width	19		
		Seat Width	20¼				

To You In 10 DAYS ...or Less
 Shaded model numbers are available on our "To You in 10 Days or Less" Quick Delivery program and will be delivered within 10 days.

To Order, Specify:

1. Model Number
 2. Fabric Grade Number
 3. Cover Number
 4. Pneumatic Cylinder Height
 5. Casters
- See page 205 for Fuel options

**Mid Back
 High Performance
 Height Adjustment Arm
 Synchronous**

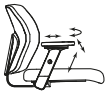

High Performance
 Height Adjustment Arm

Model No. Grade / List Price

Quick Delivery Models: QN35ACCD, QN35ACCDs, QN35AECD, QN35AECDs

		1	2/COM	3/COL	4	6	7	L7	L8
N35ACCD	Plastic Back	\$ 992	1015	1026	1042	1092	1133	1330	1393
N35ACCDs	Plastic Back/Seatslide	1090	1113	1124	1140	1190	1231	1428	1491
N35AECD	Upholstered Back	1022	1061	1080	1107	1192	1262	1597	1704
N35AECDs	Upholstered Back/Seatslide	1119	1158	1177	1204	1289	1359	1694	1801

Dimensions

Width	27	Arm Height	26-33	Seat Depth	17½	Weight	50
Depth	25	Arm Width	17½	Seat Depth with		Weight with	
Depth with		Seat Height	17¼-21¾	Seatslide	17-20	Seatslide	53
Seatslide	24½-26½	Seat Height with		Back Height	23-25	Cubic Ft.	20.4
Height	39-46½	Seatslide	18-22½	Back Width	19		
		Seat Width	20¼				

**Mid Back
 High Performance
 Height/Width Adjustment
 Arm
 Synchronous**

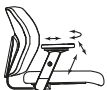

High Performance
 Height/Width Adjustment Arm

Quick Delivery Models: QN35A0CD, QN35A0CDs, QN35APCD, QN35APCDs

		1	2/COM	3/COL	4	6	7	L7	L8
N35A0CD	Plastic Back	\$ 1087	1112	1124	1142	1197	1242	1459	1528
N35A0CDs	Plastic Back/Seatslide	1175	1200	1212	1230	1285	1330	1547	1616
N35APCD	Upholstered Back	1115	1154	1173	1200	1285	1355	1690	1797
N35APCDs	Upholstered Back/Seatslide	1205	1244	1263	1290	1375	1445	1780	1887

Dimensions

Width	27	Arm Height	26-33	Seat Depth	17½	Weight	51
Depth	25	Arm Width	17¼-19½	Seat Depth with		Weight with	
Depth with		Seat Height	17¼-21¾	Seatslide	17-20	Seatslide	54
Seatslide	24½-26½	Seat Height with		Back Height	23-25	Cubic Ft.	20.4
Height	39	Seatslide	18-22½	Back Width	19		
		Seat Width	20¼				

**Stool
Armless
Knee Tilt**



**Model
No.** **Grade / List Price**

Quick Delivery Models: QN35EAC, QN35EBC

		1	2/COM	3/COL	4	6	7	L7	L8
N35EAC	Plastic Back	\$ 832	853	863	877	922	959	1136	1193
N35EBC	Upholstered Back	862	897	913	937	1012	1074	1369	1464

Dimensions

Width	26	Seat Height	21-28¼	Seat Depth	17	Weight	45
Depth	26	Seat Width	20¼	Back Height	17¼-19¼	Cubic Ft.	18
Height	37-47½			Back Width	18		

**Stool
Height/Width Arm
Knee Tilt**



Height/Width Arm

Quick Delivery Models: QN35ECC, QN35EEC

		1	2/COM	3/COL	4	6	7	L7	L8
N35ECC	Plastic Back	\$ 983	1004	1014	1028	1073	1110	1287	1344
N35EEC	Upholstered Back	1014	1049	1065	1089	1164	1226	1521	1616

Dimensions

Width	26-27½	Arm Height	30¾-40½	Seat Depth	17	Weight	51
Depth	26	Arm Width	17¼-19½	Back Height	17¼-19¼	Cubic Ft.	18
Height	37-47½	Seat Height	21-28¼	Back Width	18		
		Seat Width	20¼				

**Stool
High Performance
Height/Width Adjustment
Arm
Knee Tilt**



High Performance
Height/Width Adjustment Arm

Quick Delivery Models: QN35ECCD, QN35EECD

		1	2/COM	3/COL	4	6	7	L7	L8
N35ECCD	Plastic Back	\$ 1095	1116	1126	1140	1185	1222	1399	1456
N35EECD	Upholstered Back	1126	1161	1177	1201	1276	1338	1633	1728

Dimensions

Width	26-27½	Arm Height	31¾-41½	Seat Depth	17	Weight	51
Depth	26	Arm Width	17¼-19½	Back Height	17¼-19¼	Cubic Ft.	18
Height	37-47½	Seat Height	21-28¼	Back Width	18		
		Seat Width	20¼				

To You In 10 DAYS ...or Less Shaded model numbers are available on our "To You in 10 Days or Less" Quick Delivery program and will be delivered within 10 days.

To Order, Specify:

1. Model Number
 2. Fabric Grade Number
 3. Cover Number
 4. Casters
- See page 205 for Fuel options

**Large and Tall
Armless
Synchronous Tilt Control**



Model No. Grade / List Price

Quick Delivery Model: QN35MAC

		1	2/COM	3/COL	4	6	7	L7	L8
N35MAC	Upholstered Back	\$ 1573	1633	1661	1703	1833	1940	2452	2616

Dimensions

Width	31¼	Seat Height	18-22¼	Back Height	24-26¼	Weight	69
Depth	27½	Seat Width	24¼	Back Width	20¼	Cubic Ft.	25.5
Height	39½-47¼	Seat Depth	18				

- Tested to and meets 425 lb. weight load

**Large and Tall
Static Loop Arm
Synchronous Tilt Control**



Quick Delivery Model: QN35MBC

		1	2/COM	3/COL	4	6	7	L7	L8
N35MBC	Upholstered Back	\$ 1755	1815	1843	1885	2015	2122	2634	2798

Dimensions

Width	31¼	Arm Height	10	Seat Depth	18	Weight	70
Depth	27½	Arm Width	23¼	Back Height	24-26¼	Cubic Ft.	25.5
Height	39½-47¼	Seat Height	18-22¼	Back Width	20¼		
		Seat Width	24¼				

- Tested to and meets 425 lb. weight load

**Intensive Use
Armless
Synchronous**



**Model
No.**

Grade / List Price

Quick Delivery Model: QN35JAC

		1	2/COM	3/COL	4	6	7	L7	L8
N35JAC	Plastic Back	\$ 1151	1176	1188	1206	1261	1306	1523	1592

Dimensions

Width	27½	Seat Height	16½-21	Back Height	23¼-25½	Weight	56
Depth	25½	Seat Width	20½	Back Width	18	Cubic Ft.	18.3
Height	38¼-45¾	Seat Depth	17¼				

**Intensive Use
Static Loop Arm
Synchronous**



Quick Delivery Model: QN35JCC

		1	2/COM	3/COL	4	6	7	L7	L8
N35JCC	Plastic Back	\$ 1332	1357	1369	1387	1442	1487	1704	1773

Dimensions

Width	27½	Arm Height	10	Seat Depth	17¼	Weight	58
Depth	25½	Arm Width	19½	Back Height	23¼-25½	Cubic Ft.	18.3
Height	38¼-45¾	Seat Height	16½-21	Back Width	18		
		Seat Width	20½				

Type of Test	Federal Intensive Usage Testing Requirements for FED-STD 834	ANSI/BIFMA Acceptance
Cyclic Back and Back Tilt Mechanism Fatigue Test	1,000,000 Cycles Minimum	120,000 Cycles
Cyclic Vertical Load Test on 1 Arm	100 lbs. to 250 lbs. in 50 lb. Increments 25,000 Cycles at Each Load Level	200 lbs. 1 Time Function Load 300 lbs. 1 Time Proof Load 2,500 lbs. 1 Time Proof Load (Base Only)
Cyclic Vertical Load Test on Seats, Bases and Casters	200 lbs. to 1300 lbs. in 50 lb. Increments 25,000 Cycles at Each Load Level	3,000 lbs. 6" 1 Drop 2,500 lbs. 1 Load (Base Only)
Cyclic Side Thrust Load Test on Arms	50 lbs. to 200 lbs. in 50 lb. Increments 25,000 Cycles at Each Load Level	100 lbs. 1 Time Function Load 150 lbs. 1 Time Proof Load
Cyclic Pneumatic Seat Height Adjustment Test	250 lbs. Cyclic Seat Load Cycle Pneumatic Unit 125,000 Full Cycles	No Comparable Test Requirement
Caster/Chair Base Durability Test	36,000 Cycles 5 lbs. Retention After Cycling	36,000 Cycles 5 lbs. Retention Minimum After Cycling

Gotcha™

GOTCHA PRODUCT SPECIFICATIONS

23/24/25/26 Series

SEAT CONSTRUCTION

- Recycled plastic inner seat shell designed with a deep ribbing pattern to ensure rigidity

BACK CONSTRUCTION

- Injection molded polypropylene outer shell
- Blow molded polyethylene inner back shell designed with a deep ribbing to ensure rigidity

BACK REST

- Back height can be adjusted by simply lifting up on the back
- The range of the adjustment is approximately 2½"

ARMS

- Arms attached to the seat with metal brackets and screws
- Adjustable arms adjust 2½" in height and 3" in width for optimum comfort
- Fully adjustable arms allow arm pad to be rotated to 3 different positions for better ergonomic use
- All arms have encased uprights made of reinforced nylon
- Arm pads are soft polyurethane
- High performance arms have arm pads that adjust in depth, width, and pivot as well as arm height and width adjustment

CONTROL MECHANISM (23/24 Series)—KNEE TILT

- Standard knee tilt mechanism features heavy-duty adjustable tension spring for a variety of body sizes and minimal rise of front seat edge; this allows the user's feet to remain planted when chair is in a reclining position
- The combination gas lift/tilt lock lever allows dual function with simple in/out movement for lockout and up/down movement for height adjustment

CONTROL MECHANISM (25/26 Series)—SYNCHRONOUS

- Synchronous control allows the back and seat to move in a synchronized 2.3:1 ratio motion
- Free float feature allows the chair to tilt freely
- A side activated telescoping tension adjustment handle provides a comfortable way to adjust back tension to meet individual needs
- The back angle can be locked in one of five positions
- Standard pneumatic gas cylinder lift allows seat to raise and lower 4¼" and provides spring action for added comfort
- Seat slide option adjusts seat depth within a 2½" range

SEATSLIDE (N24/N26 Models)

- Seat depth can be adjusted within a 2½" range

LIFT

- Standard pneumatic gas cylinder lift allows seat to raise and lower 5" and provides spring action for added comfort
- Finger grip lever adjustment is quick and easy

BASE AND CASTERS

- Nylon five-prong base features black glass filled nylon for beauty and a long life
- Black, hard double wheel casters, which work on multiple surfaces, are standard
- Black, soft double wheel casters are available for use on hard floors; upcharge applies to this option
- Gotcha 24 hr. use models feature a steel understructure base with a one piece polypropylene overlay and heavy-duty black double wheel casters

FINISH

- All arms and bases feature standard black finish and coatings

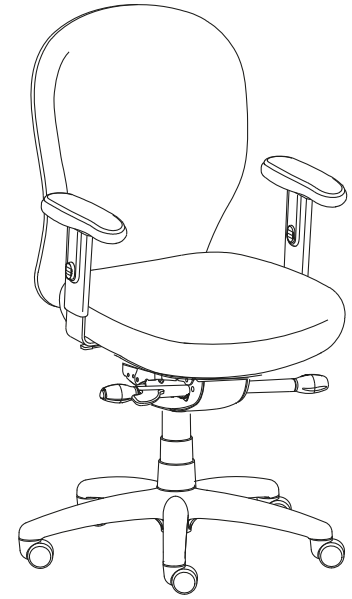

All Gotcha models may be ordered to meet TB133 fire code.

To order seating to meet the TB133 fire code, specify an "F" at the end of the model number (Ex: N25AACF).

Reference pages 465-493 for TB133 Fabric Matrix and pricing.

Please consult customer service for applicable Arc-Com, COM, Maharam, Momentum, Stinson or Ultrafabrics fabric.



For comprehensive sustainability information that includes LEED® point contribution, visit NationalOfficeFurniture.ecoScorecard.com.

FABRICS

Grade 1 American Graffiti
 Cali
 Plush
 Ridge
 Speedway
 Stardust

Grade 2 Cathedral
 COM
 Orbit
 Pixie
 Sedona
 Shenanigans
 Spectrum
 *Strand
 Tranquility
 Twilight

*Strand restricted on upholstered back models

Grade 3 Boardwalk
 COL
 Jacks
 Pop Rocks

Grade 4 Big City
 Bumble
 Connect Four
 Echo
 Silvertex

Grade 6 Essence/Ultraleather
 Flock
 Scribe

Grade 7 Brisa
 Brisa Distressed
 Promessa
 Silica

Grade L7 Davenport

Grade L8 Showcase

FINISHES

Standard Black

CASTERS

C15 Hard (standard)
 C2 Soft (add \$24 list)

24 Hour Seating Only

C3 Hard (standard)
 C4 Soft (add \$24 list)

To Order, Specify:

1. Model Number
2. Fabric Grade Number
3. Cover Number
4. Casters

• See page 221 for Gotcha options

**Low Back
Armless
Knee Tilt**



Model No.	Grade / List Price								
		1	2/COM	3/COL	4	6	7	L7	L8
N23AAC	Plastic Back	\$ 646	667	677	691	736	773	950	1007
N24AAC	Plastic Back/Seatslide	744	765	775	789	834	871	1048	1105
N23BBC	Upholstered Back	677	712	728	752	827	889	1184	1279
N24BBC	Upholstered Back/Seatslide	774	809	825	849	924	986	1281	1376

Dimensions

Width	26¼	Seat Height	16½-21¼	Seat Depth	17¼	Weight	48
Depth	26¼	Seat Height with Seatslide	17¼-22	Seat Depth with Seatslide	17¼-19¾	Weight with Seatslide	49
Depth with Seatslide	26¼-28¾	Seat Width	19¾	Back Height	18½-20½	Cubic Ft.	14.4
Height	33¾-41			Back Width	16½		
Height with Seatslide	34½-41¾						

**Low Back
Adjustable Arms
Knee Tilt**



Model No.	Grade / List Price								
		1	2/COM	3/COL	4	6	7	L7	L8
N23CCC	Plastic Back	\$ 797	818	828	842	887	924	1101	1158
N24CCC	Plastic Back/Seatslide	890	911	921	935	980	1017	1194	1251
N23EEC	Upholstered Back	827	862	878	902	977	1039	1334	1429
N24EEC	Upholstered Back/Seatslide	923	958	974	998	1073	1135	1430	1525

Dimensions

Width	26¼-27¾	Arm Height	24¾-32½	Seat Depth	17½	Weight	56
Depth	26¼	Arm Width	18-21½	Seat Depth with Seatslide	17¼-19¾	Weight with Seatslide	57
Depth with Seatslide	26¼-28¾	Seat Height	16½-21¼	Back Height	18½-20½	Cubic Ft.	14.4
Height	33¾-41	Seat Height with Seatslide	17¼-22	Back Width	16½		
Height with Seatslide	34½-41¾	Seat Width	19¾				



Adjustable Arms

**Low Back
Fully Adjustable Arms
Knee Tilt**



Fully Adjustable Arms

**Model
No.**

Grade / List Price

		1	2/COM	3/COL	4	6	7	L7	L8
N23JJC	Plastic Back	\$ 878	899	909	923	968	1005	1182	1239
N24JJC	Plastic Back/Seatslide	974	995	1005	1019	1064	1101	1278	1335
N23MMC	Upholstered Back	909	944	960	984	1059	1121	1416	1511
N24MMC	Upholstered Back/Seatslide	1004	1039	1055	1079	1154	1216	1511	1606

Dimensions

Width	26¼-27¾	Arm Height	25½-32¾	Seat Depth	17½	Weight	57
Depth	26¼	Arm Width	16¾-21½	Seat Depth with		Weight with	
Depth with		Seat Height	16½-21¼	Seatslide	17¼-19¾	Seatslide	58
Seatslide	26¼-28¾	Seat Height with		Back Height	18½-20½	Cubic Ft.	14.4
Height	33¾-41	Seatslide	17¼-22	Back Width	16½		
Height with		Seat Width	19¾				
Seatslide	34½-41¾						

**Low Back
High Performance Arms
Knee Tilt**



High Performance Arms

		1	2/COM	3/COL	4	6	7	L7	L8
N23CCCD	Plastic Back	\$ 909	930	940	954	999	1036	1213	1270
N24CCCD	Plastic Back/Seatslide	1003	1024	1034	1048	1093	1130	1307	1364
N23EECD	Upholstered Back	940	975	991	1015	1090	1152	1447	1542
N24EECD	Upholstered Back/Seatslide	1035	1070	1086	1110	1185	1247	1542	1637

Dimensions

Width	26¼-27¾	Arm Height	25¾-33½	Seat Depth	17½	Weight	57
Depth	26¼	Arm Width	16¾-21½	Seat Depth with		Weight with	
Depth with		Seat Height	16½-21¼	Seatslide	17¼-19¾	Seatslide	58
Seatslide	26¼-28¾	Seat Height with		Back Height	18½-20½	Cubic Ft.	14.4
Height	33¾-41	Seatslide	17¼-22	Back Width	16½		
Height with		Seat Width	19¾				
Seatslide	34½-41¾						

To Order, Specify:

1. Model Number
2. Fabric Grade Number
3. Cover Number
4. Casters

• See page 221 for Gotcha options

**Mid Back
Armless
Knee Tilt**



Model No.	Grade / List Price								
		1	2/COM	3/COL	4	6	7	L7	L8
N23SSC	Plastic Back, Armless	\$ 697	720	731	747	797	838	1035	1098
N24SSC	Plastic Back/Seatslide, Armless	791	814	825	841	891	932	1129	1192
N23RRC	Upholstered Back, Armless	729	766	783	809	889	955	1270	1371
N24RRC	Upholstered Back/Seatslide, Armless	821	858	875	901	981	1047	1362	1463

Dimensions

Width	26¼	Seat Height	16½-21½	Seat Depth	17½	Weight	49
Depth	26¼	Seat Height with Seatslide	17-22¼	Seat Depth with Seatslide	17½-19¾	Weight with Seatslide	50
Depth with Seatslide	26¼-28¾	Seat Width	19¾	Back Height	22-23¾	Cubic Ft.	14.3
Height	37-44¼			Back Width	17½		
Height with Seatslide	37¾-45						

**Mid Back
Adjustable Arms
Knee Tilt**



Model No.	Grade / List Price								
		1	2/COM	3/COL	4	6	7	L7	L8
N23DDC	Plastic Back	\$ 812	835	846	862	912	953	1150	1213
N24DDC	Plastic Back/Seatslide	909	932	943	959	1009	1050	1247	1310
N23HHC	Upholstered Back	845	882	899	925	1005	1071	1386	1487
N24HHC	Upholstered Back/Seatslide	939	976	993	1019	1099	1165	1480	1581

Dimensions

Width	26¼-27¾	Arm Height	24¾-32½	Seat Depth	17½	Weight	57
Depth	26¼	Arm Width	18-21½	Seat Depth with Seatslide	17½-19¾	Weight with Seatslide	58
Depth with Seatslide	26¼-28¾	Seat Height	16½-21½	Back Height	22-23¾	Cubic Ft.	14.3
Height	37-44¼	Seat Height with Seatslide	17½-22	Back Width	17½		
Height with Seatslide	37¾-45	Seat Width	19¾				



Adjustable Arms

**Mid Back
Fully Adjustable Arms
Knee Tilt**



Fully Adjustable Arms

Model No.		Grade / List Price							
		1	2/COM	3/COL	4	6	7	L7	L8
N23KKC	Plastic Back	\$ 896	919	930	946	996	1037	1234	1297
N24KKC	Plastic Back/Seatslide	989	1012	1023	1039	1089	1130	1327	1390
N23PPC	Upholstered Back	925	962	979	1005	1085	1151	1466	1567
N24PPC	Upholstered Back/Seatslide	1021	1058	1075	1101	1181	1247	1562	1663

Dimensions

Width	26¼-27¾	Arm Height	24¾-33	Seat Depth	17½	Weight	57
Depth	26¼	Arm Width	16¾-21½	Seat Depth with		Weight with	
Depth with		Seat Height	16½-21½	Seatslide	17½-19¾	Seatslide	58
Seatslide	26¼-28¾	Seat Height with		Back Height	22-23¾	Cubic Ft.	14.3
Height	37-44¼	Seatslide	17½-22	Back Width	17½		
Height with		Seat Width	19¾				
Seatslide	37¾-45						

**Mid Back
High Performance Arms
Knee Tilt**



High Performance Arms

Model No.		Grade / List Price							
		1	2/COM	3/COL	4	6	7	L7	L8
N23DDCD	Plastic Back	\$ 924	947	958	974	1024	1065	1262	1325
N24DDCD	Plastic Back/Seatslide	1022	1045	1056	1072	1122	1163	1360	1423
N23HHCD	Upholstered Back	957	994	1011	1037	1117	1183	1498	1599
N24HHCD	Upholstered Back/Seatslide	1052	1089	1106	1132	1212	1278	1593	1694

Dimensions

Width	26¼-27¾	Arm Height	25¾-33½	Seat Depth	17½	Weight	57
Depth	26¼	Arm Width	16¾-21½	Seat Depth with		Weight with	
Depth with		Seat Height	16½-21½	Seatslide	17½-19¾	Seatslide	58
Seatslide	26¼-28¾	Seat Height with		Back Height	22-23¾	Cubic Ft.	14.3
Height	37-44¼	Seatslide	17½-22	Back Width	17½		
Height with		Seat Width	19¾				
Seatslide	37¾-45						

To Order, Specify:

1. Model Number
2. Fabric Grade Number
3. Cover Number
4. Casters

• See page 221 for Gotcha options

**Low Back Stool
Armless
Knee Tilt**



Model No.	Grade / List Price									
		1	2/COM	3/COL	4	6	7	L7	L8	
N23AACY	Plastic Back, Armless	\$ 808	829	839	853	898	935	1112	1169	
N23BBCY	Upholstered Back, Armless	838	873	889	913	988	1050	1345	1440	
Dimensions										
Width	26¼	Seat Height	24½-34½	Back Height	18-20¾	Weight	58			
Depth	26¼	Seat Depth	17½	Back Width	16½	Cubic Ft.	20.4			
Height	42½-55¼	Seat Width	19¾							

**Low Back Stool
Adjustable Arms
Knee Tilt**



Model No.	Grade / List Price									
		1	2/COM	3/COL	4	6	7	L7	L8	
N23CCCY	Plastic Back	\$ 958	979	989	1003	1048	1085	1262	1319	
N23EECY	Upholstered Back	988	1023	1039	1063	1138	1200	1495	1590	
Dimensions										
Width	26¼-27¾	Seat Height	24½-34½	Arm Height	26½-33½	Weight	62			
Depth	26¼	Seat Depth	17½	Back Height	18-20¾	Cubic Ft.	20.4			
Height	42½-55¼	Seat Width	19¾	Back Width	16½					



Adjustable Arms

**Low Back Stool
High Performance Arms
Knee Tilt**



Model No.	Grade / List Price									
		1	2/COM	3/COL	4	6	7	L7	L8	
N23CCCYD	Plastic Back	\$ 1070	1091	1101	1115	1160	1197	1374	1431	
N23EECYD	Upholstered Back	1100	1135	1151	1175	1250	1312	1607	1702	
Dimensions										
Width	26¼-27¾	Seat Height	24½-34½	Arm Height	27½-34½	Weight	62			
Depth	26¼	Seat Depth	17½	Back Height	18-20¾	Cubic Ft.	20.4			
Height	42½-55¼	Seat Width	19¾	Back Width	16½					



High Performance Arms

**Low Back
Armless
Synchronous**



Model No.		Grade / List Price							
		1	2/COM	3/COL	4	6	7	L7	L8
N25AAC	Plastic Back	\$ 740	761	771	785	830	867	1044	1101
N26AAC	Plastic Back/Seatslide	835	856	866	880	925	962	1139	1196
N25BBC	Upholstered Back	768	803	819	843	918	980	1275	1370
N26BBC	Upholstered Back/Seatslide	864	899	915	939	1014	1076	1371	1466
Dimensions									
Width	26¼	Seat Height	16½-21¼	Seat Depth	17½	Weight	48		
Depth	25¼	Seat Height with Seatslide	17-22¼	Seat Depth with Seatslide	17-20	Weight with Seatslide	49		
Depth with Seatslide	25¼-29	Seat Width	19¾	Back Height	18-20¾	Cubic Ft.	14.4		
Height	34-42			Back Width	16½				
Height with Seatslide	34½-42½								

**Low Back
Adjustable Arms
Synchronous**



Adjustable Arms

Model No.		Grade / List Price							
		1	2/COM	3/COL	4	6	7	L7	L8
N25CCC	Plastic Back	\$ 888	909	919	933	978	1015	1192	1249
N26CCC	Plastic Back/Seatslide	984	1005	1015	1029	1074	1111	1288	1345
N25EEC	Upholstered Back	921	956	972	996	1071	1133	1428	1523
N26EEC	Upholstered Back/Seatslide	1015	1050	1066	1090	1165	1227	1522	1617
Dimensions									
Width	25½-27	Arm Height	25¼-33¾	Seat Depth	17½	Weight	56		
Depth	25¼	Arm Width	18½-21½	Seat Depth with Seatslide	17-20	Weight with Seatslide	57		
Depth with Seatslide	25¼-29	Seat Height	16½-21½	Back Height	18-20¾	Cubic Ft.	14.4		
Height	34-42	Seat Height with Seatslide	17-22¼	Back Width	16½				
Height with Seatslide	34½-42½	Seat Width	19¾						

**Low Back
Fully Adjustable Arms
Synchronous**



Fully Adjustable Arms

Model No.		Grade / List Price							
		1	2/COM	3/COL	4	6	7	L7	L8
N25JJC	Plastic Back	\$ 970	991	1001	1015	1060	1097	1274	1331
N26JJC	Plastic Back/Seatslide	1064	1085	1095	1109	1154	1191	1368	1425
N25MMC	Upholstered Back	1002	1037	1053	1077	1152	1214	1509	1604
N26MMC	Upholstered Back/Seatslide	1096	1131	1147	1171	1246	1308	1603	1698
Dimensions									
Width	25½-27¾	Arm Height	25¾-34¼	Seat Depth	17½	Weight	56		
Depth	25¼	Arm Width	18½-21½	Seat Depth with Seatslide	17-20	Weight with Seatslide	57		
Depth with Seatslide	25¼-29	Seat Height	16½-21½	Back Height	18-20¾	Cubic Ft.	14.4		
Height	34-42	Seat Height with Seatslide	17-22¼	Back Width	16½				
Height with Seatslide	34½-42½	Seat Width	19¾						

To You In 10 DAYS ...or Less
 Shaded model numbers are available on our "To You in 10 Days or Less" Quick Delivery program and will be delivered within 10 days.

To Order, Specify:

1. Model Number
2. Fabric Grade Number
3. Cover Number
4. Casters

• See page 221 for Gotcha options

Low Back High Performance Arms Synchronous



High Performance Arms

Model No.	Grade / List Price	Grade / List Price							
		1	2/COM	3/COL	4	6	7	L7	L8
N25CCCD	Plastic Back	\$ 1000	1021	1031	1045	1090	1127	1304	1361
N26CCCD	Plastic Back/Seatslide	1096	1117	1127	1141	1186	1223	1400	1457
N25EECD	Upholstered Back	1033	1068	1084	1108	1183	1245	1540	1635
N26EECD	Upholstered Back/Seatslide	1127	1162	1178	1202	1277	1339	1634	1729

Dimensions

Width	25½-27¾	Arm Height	26¼-34¾	Seat Depth	17½	Weight	56
Depth	25¼	Arm Width	18½-21½	Seat Depth with Seatslide	17-20	Weight with Seatslide	57
Depth with Seatslide	25¼-29	Seat Height	16½-21½	Back Height	18-20¾	Cubic Ft.	14.4
Height	34-42	Seat Height with Seatslide	17-22¼	Back Width	16½		
Height with Seatslide	34½-42½	Seat Width	19¾				

Mid Back Armless Synchronous



Model No.	Grade / List Price	Grade / List Price							
		1	2/COM	3/COL	4	6	7	L7	L8
N25SSC	Plastic Back	\$ 792	815	826	842	892	933	1130	1193
N26SSC	Plastic Back/Seatslide	883	906	917	933	983	1024	1221	1284
N25RRC	Upholstered Back	818	855	872	898	978	1044	1359	1460
N26RRC	Upholstered Back/Seatslide	911	948	965	991	1071	1137	1452	1553

Dimensions

Width	25½	Seat Height	16½-21½	Seat Depth	17	Weight	49
Depth	25¼	Seat Height with Seatslide	17-22¼	Seat Depth with Seatslide	17-20	Weight with Seatslide	50
Depth with Seatslide	25¼-29	Seat Width	19¾	Back Height	21¾-24½	Cubic Ft.	14.3
Height	37¼-45			Back Width	16¼-18¼		
Height with Seatslide	37¾-45½						

Mid Back Adjustable Arms Synchronous



Adjustable Arms

Model No.

Grade / List Price

Quick Delivery Models: QN25DDC, QN26DDC

		1	2/COM	3/COL	4	6	7	L7	L8
N25DDC	Plastic Back	\$ 905	928	939	955	1005	1046	1243	1306
N26DDC	Plastic Back/Seatslide	1002	1025	1036	1052	1102	1143	1340	1403
N25HHC	Upholstered Back	935	972	989	1015	1095	1161	1476	1577
N26HHC	Upholstered Back/Seatslide	1032	1069	1086	1112	1192	1258	1573	1674

Dimensions

Width	25½-27¾	Arm Height	25¼-33¾	Seat Depth	17	Weight	57
Depth	25¼	Arm Width	18½-21½	Seat Depth with Seatslide	17-20	Weight with Seatslide	58
Depth with Seatslide	25¼-29	Seat Height	16½-21½	Back Height	21¾-24½	Cubic Ft.	14.3
Height	37¼-45	Seat Height with Seatslide	17-22¼	Back Width	16¼-18¼		
Height with Seatslide	37¾-45½	Seat Width	19¾				

Mid Back Fully Adjustable Arms Synchronous



Fully Adjustable Arms

		1	2/COM	3/COL	4	6	7	L7	L8
N25KKC	Plastic Back	\$ 986	1009	1020	1036	1086	1127	1324	1387
N26KKC	Plastic Back/Seatslide	1084	1107	1118	1134	1184	1225	1422	1485
N25PPC	Upholstered Back	1017	1054	1071	1097	1177	1243	1558	1659
N26PPC	Upholstered Back/Seatslide	1114	1151	1168	1194	1274	1340	1655	1756

Dimensions

Width	25½-27¾	Arm Height	25¾-34¾	Seat Depth	17	Weight	57
Depth	25¼	Arm Width	18½-21½	Seat Depth with Seatslide	17-20	Weight with Seatslide	58
Depth with Seatslide	25¼-29	Seat Height	16½-21½	Back Height	21¾-24½	Cubic Ft.	14.3
Height	37¼-45	Seat Height with Seatslide	17-22¼	Back Width	16¼-18¼		
Height with Seatslide	37¾-45½	Seat Width	19¾				

Mid Back High Performance Arm Synchronous



High Performance Arms

Quick Delivery Models: QN25DDCD, QN26DDCD

		1	2/COM	3/COL	4	6	7	L7	L8
N25DDCD	Plastic Back	\$ 1018	1041	1052	1068	1118	1159	1356	1419
N26DDCD	Plastic Back/Seatslide	1115	1138	1149	1165	1215	1256	1453	1516
N25HHCD	Upholstered Back	1049	1086	1103	1129	1209	1275	1590	1691
N26HHCD	Upholstered Back/Seatslide	1144	1181	1198	1224	1304	1370	1685	1786

Dimensions

Width	25½-27¾	Arm Height	26¼-34¾	Seat Depth	17	Weight	57
Depth	25¼	Arm Width	18½-21½	Seat Depth with Seatslide	17-20	Weight with Seatslide	58
Depth with Seatslide	25¼-29	Seat Height	16½-21½	Back Height	21¾-24½	Cubic Ft.	14.3
Height	37¼-45	Seat Height with Seatslide	17-22¼	Back Width	16¼-18¼		
Height with Seatslide	37¾-45½	Seat Width	19¾				

Gotcha

24 Hour Seating

Designed for multi-shift or intensive use applications. Features molded polyurethane foam, long-life pneumatic cylinder, reinforced steel understructure base with one piece polypropylene overlay and heavy-duty black double wheel casters

To Order, Specify:

1. Model Number
2. Fabric Grade Number
3. Cover Number
4. Casters

• See page 221 for Gotcha options

Low Back Stool Armless Synchronous



Model No.	Grade / List Price									
		1	2/COM	3/COL	4	6	7	L7	L8	
N25AACY	Plastic Back	\$ 900	921	931	945	990	1027	1204	1261	
N25BBCY	Upholstered Back	931	966	982	1006	1081	1143	1438	1533	
Dimensions										
Width	25½	Seat Height	25-35	Back Height	18-20¾	Weight	58			
Depth	25¼	Seat Depth	17½	Back Width	16½	Cubic Ft.	20.4			
Height	42¾-55¾	Seat Width	19¾							

Low Back Stool Adjustable Arms Synchronous



Model No.	Grade / List Price									
		1	2/COM	3/COL	4	6	7	L7	L8	
N25CCCY	Plastic Back	\$ 1051	1086	1102	1126	1201	1263	1558	1653	
N25EECY	Upholstered Back	1083	1118	1134	1158	1233	1295	1590	1685	
Dimensions										
Width	25½-27¾	Seat Height	25-35	Arm Height	26½-33½	Weight	62			
Depth	25¼	Seat Depth	17½	Back Height	18-20¾	Cubic Ft.	20.4			
Height	42¾-55¾	Seat Width	19¾	Back Width	16½					



Adjustable Arms

Low Back Stool High Performance Arms Synchronous



Model No.	Grade / List Price									
		1	2/COM	3/COL	4	6	7	L7	L8	
N25CCCYD	Plastic Back	\$ 1163	1198	1214	1238	1313	1375	1670	1765	
N25EECYD	Upholstered Back	1195	1230	1246	1270	1345	1407	1702	1797	
Dimensions										
Width	25½-27¾	Seat Height	25-35	Arm Height	27½-34½	Weight	62			
Depth	25¼	Seat Depth	17½	Back Height	18-20¾	Cubic Ft.	20.4			
Height	42¾-55¾	Seat Width	19¾	Back Width	16½					



High Performance Arms

**Low Back
Adjustable Arms
Synchronous**



Model No.		Grade / List Price							
		1	2/COM	3/COL	4	6	7	L7	L8
N25CCCX	Plastic Back	\$ 981	1002	1012	1026	1071	1108	1285	1342
Dimensions									
Width	25½-27¾	Arm Height	25¼-33¾	Seat Depth	17	Weight	56		
Depth	25¼	Arm Width	18½-21½	Back Height	18-20¾	Cubic Ft.	14.4		
Height	34-42	Seat Height	16½-21½	Back Width	16½				
		Seat Width	19¾						



Adjustable Arms

**Low Back
High Performance Arm
Synchronous**



Model No.		Grade / List Price							
		1	2/COM	3/COL	4	6	7	L7	L8
N25CCXD	Plastic Back	\$ 1093	1114	1124	1138	1183	1220	1397	1454
Dimensions									
Width	25½-27¾	Arm Height	26¼-34¾	Seat Depth	17	Weight	56		
Depth	25¼	Arm Width	18½-21½	Back Height	18-20¾	Cubic Ft.	14.4		
Height	34-42	Seat Height	16½-21½	Back Width	16½				
		Seat Width	19¾						



High Performance Arms

**Mid Back
Adjustable Arms
Synchronous**



Model No.		Grade / List Price							
		1	2/COM	3/COL	4	6	7	L7	L8
N25DDCX	Plastic Back	\$ 996	1019	1030	1046	1096	1137	1334	1397
N26DDCX	Plastic Back/Seatslide	1093	1116	1127	1143	1193	1234	1431	1494
Dimensions									
Width	25½-27¾	Arm Height	25¼-33¾	Seat Depth	17	Weight	57		
Depth	25¼	Arm Width	18½-21½	Seat Depth with Seatslide	17-20	Weight with Seatslide	58		
Depth with Seatslide	25¼-29	Seat Height	16½-21½	Back Height	21¾-24½	Cubic Ft.	14.3		
Height	37¼/-45	Seat Height with Seatslide	17-22¼	Back Width	16¼-18¼				
Height with Seatslide	37¾-45½	Seat Width	19¾						



Adjustable Arms

Gotcha

24 Hour Seating

Designed for multi-shift or intensive use applications. Features molded polyurethane foam, long-life pneumatic cylinder, reinforced steel understructure base with one piece polypropylene overlay and heavy-duty black double wheel casters

To Order, Specify:

1. Model Number
2. Fabric Grade Number
3. Cover Number
4. Casters

• See page 221 for Gotcha options

Mid Back Fully Adjustable Arms Synchronous



Model No.	Grade / List Price								
		1	2/COM	3/COL	4	6	7	L7	L8
N26KKCX	Plastic Back/Seatslide	\$ 1172	1195	1206	1222	1272	1313	1510	1573

Dimensions

Width	25½-27¾	Arm Height	25¾-34¼	Seat Depth	17	Weight	57
Depth	25¼	Arm Width	18½-21½	Seat Depth with Seatslide	17-20	Weight with Seatslide	58
Depth with Seatslide	25¼-29	Seat Height	16½-21½	Back Height	21¾-24½	Cubic Ft.	14.3
Height	37¼-45	Seatslide	17-22¼	Back Width	16¼-18¼		
Height with Seatslide	37¾-45½	Seat Width	19¾				



Fully Adjustable Arms

Mid Back High Performance Arm Synchronous



Model No.	Grade / List Price								
		1	2/COM	3/COL	4	6	7	L7	L8
N25DDCXD	Plastic Back	\$ 1108	1131	1142	1158	1208	1249	1446	1509
N26DDCXD	Plastic Back/Seatslide	1205	1228	1239	1255	1305	1346	1543	1606

Dimensions

Width	25½-27¾	Arm Height	26¼-34¾	Seat Depth	17	Weight	57
Depth	25¼	Arm Width	18½-21½	Seat Depth with Seatslide	17-20	Weight with Seatslide	58
Depth with Seatslide	25¼-29	Seat Height	16½-21½	Back Height	21¾-24½	Cubic Ft.	14.3
Height	37¼-45	Seatslide	17-22¼	Back Width	16¼-18¼		
Height with Seatslide	37¾-45½	Seat Width	19¾				



High Performance Arms

Jewel™

Jewel

JEWEL PRODUCT SPECIFICATIONS

N44 Series

FRAME CONSTRUCTION

- 2⁵/₃₂" hot rolled, welded, chrome plated, tubular steel

SEAT AND BACK

- 7/16" molded plywood cross banded for strength
- Custom molded and contoured for comfort and support

ARM CAPS

- 1⁵/₈" thick solid bentwood, finished to match the shell

GLIDES

- Black nylon glides are standard

FINISH

- Brighton, Acorn, grey, and black feature a catalyzed top coat
- White is enamel paint
- When specifying Brighton, Acorn, and grey finish, variation in color is acceptable due to the nature of beech wood characteristics

WOOD

- Beech

STACKABILITY

- Side chair and stools are each stackable up to four high
- Rubber stack bumper are standard

GANGING BRACKETS

- Sold in package of 5 pairs
- One pair is required to gang two chairs, two pairs will gang three chairs
- Ganging bracket snap onto the legs
- Armless models or alternating armless and armchair may be connected
- Two armchair models cannot be ganged side by side

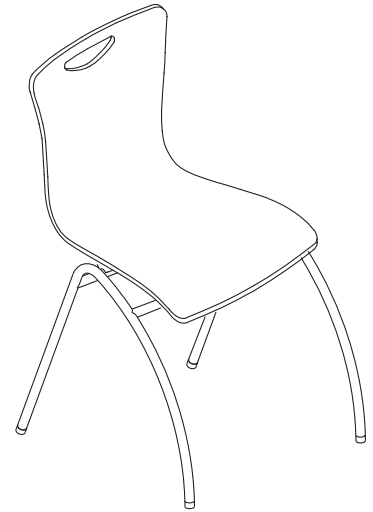

To You In
10 DAYS
...or Less

Shaded model numbers are available on our "To You in 10 Days or Less" Quick Delivery program and will be delivered within 10 days.

To Order, Specify:

1. Model Number

Armless



Model No. Grade / List Price

N44GM1W793	Acorn	\$ 437
N44GM1WIM	Brighton	437
N44GM1WBL	Black	437
N44GM1WGR	Grey	437
N44GM1WWH	White	437

Dimensions

Width	19¾	Seat Height	18½	Back Height	17¾	Weight	15
Depth	23¾	Seat Depth	17¾	Back Width	17¼	Cubic Ft.	4.5
Height	31¾	Seat Width	18				

- Chairs will be shipped four per carton when applicable

Arm



Model No.

Grade / List Price

N44GA1W793	Acorn	\$ 539
N44GA1WIM	Brighton	539
N44GA1WBL	Black	539
N44GA1WGR	Grey	539
N44GA1WWH	White	539

Dimensions

Width	19¾	Seat Height	18¾	Arm Height	26½	Weight	18
Depth	23¾	Seat Depth	17¾	Back Height	17¾	Cubic Ft.	4.5
Height	31¾	Seat Width	18	Back Width	17¼		

- Chairs will be shipped four per carton when applicable

Armless Stool

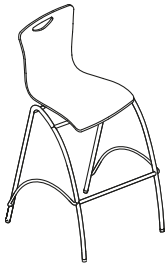

N44SM2W793	Acorn, Package of 2	\$ 1313
N44SM2WIM	Brighton, Package of 2	1313
N44SM2WBL	Black, Package of 2	1313
N44SM2WGR	Grey, Package of 2	1313
N44SM2WWH	White, Package of 2	1313

Dimensions

Width	44½	Seat Height	29¾	Back Height	17¾	Weight	24.5
Depth	24¾	Seat Depth	17¾	Back Width	17¼	Cubic Ft.	9.6
Height	43¾	Seat Width	18				

Gangng Bracket



N44GB	Package of 5 pairs	\$ 51
--------------	--------------------	--------------

Dimensions

Width	4½	Weight	4
Depth	1	Cubic Ft.	0.5
Height	1½		

- One pair is required to gang two chairs, two pairs will gang three chairs
- Armless models or alternating armless and arm chair may be ganged
- Two arm chairs cannot be ganged together

Jiminy®

Jiminy

JIMINY PRODUCT SPECIFICATIONS

N52 Series

FRAME CONSTRUCTION

- Legs are made of 1¼" x ⅝" thick steel for strength and durability
- Cross members are constructed of ⅝" x 14-gauge thick steel
- Leg is joined to cross member bar with metal inert gas (MIG) welds
- Flexible back mechanism and frame connectors are die-cast polished aluminum

SEAT CONSTRUCTION

- 1⅝" of high grade polyurethane foam
- Contoured, injection molded nylon seat panel with an inner polyethylene seat support

BACK CONSTRUCTION

- Contoured, injection mold glass filled nylon
- Flexible back mechanism allows 9 degrees of recline

MESH

- 64% polyelastomeric, 36% polyester
- Cleaning code W
- 100,000+ double rubs

ARMREST

- ABS plastic arm cap attached to a glass filled nylon arm support
- Arms adjust 2" forward to backward

GLIDES

- Durable hard black nylon glides
- Back static legs feature small glide rollers to allow for ease of mobility when nesting
- Soft glides are available at an upcharge
- Soft glides do not feature small glide roller on back legs

CASTERS

- 44 mm black double wheel, which work on multiple surfaces
- Soft, double wheel casters, for use on hard floors, are available at an upcharge

FINISH

- Cinder and Platinum Metallic frames are finished with electrostatically baked-on powder coat paint

NESTED DIMENSIONS

- Nested depth of two chairs is 31"; add 10" for each additional nested chair

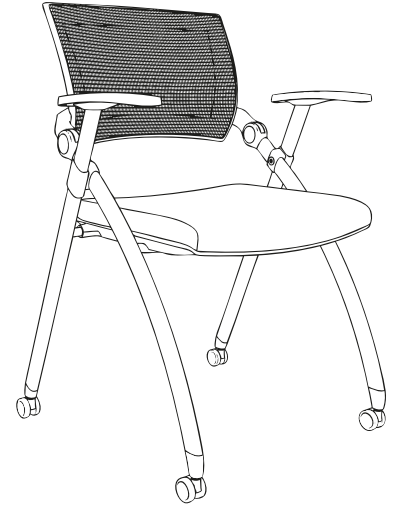

All Jiminy models may be ordered to meet TB133 fire code.

To order seating to meet the TB133 fire code specify an "F" at the end of the model number (Ex: N52GHMF).

Please consult customer service for applicable Arc-Com, COM, Maharam, Momentum, Stinson or Ultrafabrics fabric.

FABRICS

- Grade 1 American Graffiti
- Cali
- Plush
- Ridge
- Speedway
- Stardust
- Grade 2 Cathedral
- COM
- Orbit
- Pixie
- Sedona
- Shenanigans
- Spectrum
- Strand
- Tranquility
- Twilight

- Grade 3 Boardwalk
- COL
- Jacks
- Pop Rocks
- Grade 4 Big City
- Bumble
- Connect Four
- Echo
- Silvertex
- Grade 6 Essence/Ultraleather
- Flock
- Scribe

- Grade 7 Brisa
- Brisa Distressed
- Promessa
- Silica
- Grade L7 Davenport
- Grade L8 Showcase

FRAME COLORS

- 462 Cinder
- 501 Platinum Metallic

CASTERS

- C11 Hard (standard)
- C12 Soft (add \$24 list)

GLIDES

- STD Standard
- C21 Soft (add \$22 list)

Jiminy

To You In
10 DAYS
...or Less

Shaded model numbers are available on our "To You in 10 Days or Less" Quick Delivery program and will be delivered within 10 days.

To Order, Specify:

1. Model Number
2. Fabric Grade Number
3. Cover Number
4. Frame Color
5. Glides or Casters

• See page 241 for Jiminy options

Static		Model No.		Grade / List Price									
<p>N52GHM</p>		Quick Delivery Models: QN52GHM, QN52GHA											
				1	2/COM	3/COL	4	6	7	L7	L8		
N52GHA													
<p>N52GHA</p>		Quick Delivery Models: QN52GHMC, QN52GHAC											
				1	2/COM	3/COL	4	6	7	L7	L8		
N52GHMC													
N52GHAC													

Dimensions

Width	23½	Seat Height	17¾	Arm Height	26½	Weight	23
Depth	22	Seat Depth	16¾	Back Height	16¾	Cubic Ft.	14.5
Height	33½	Seat Width	17½	Back Width	17		

- Chairs will be shipped four per carton when applicable

Mobile		Model No.		Grade / List Price									
<p>N52GHMC</p>		Quick Delivery Models: QN52GHMC, QN52GHAC											
				1	2/COM	3/COL	4	6	7	L7	L8		
N52GHAC													
<p>N52GHAC</p>		Quick Delivery Models: QN52GHMC, QN52GHAC											
				1	2/COM	3/COL	4	6	7	L7	L8		
N52GHMC													
N52GHAC													

Dimensions

Width	23½	Seat Height	17¾	Arm Height	26½	Weight	23
Depth	22	Seat Depth	16¾	Back Height	16¾	Cubic Ft.	17
Height	33½	Seat Width	17½	Back Width	17		

- Chairs will be shipped four per carton when applicable

Lavoro™

Lavoro

LAVORO PRODUCT SPECIFICATIONS

30 Series

FRAME CONSTRUCTION

Guest Models

- Legs and crossmembers are made of 1" tubular steel
- Available in polished aluminum or Cinder powder coat
- Wall saving design feature on mobile models

SEAT CONSTRUCTION

Task Models

- 2½" of high grade polyurethane foam covers a contoured injection molded seat panel

Guest Models

- 1½" of high grade polyurethane foam covers an injection molded seat panel

BACK CONSTRUCTION

Task Models

- Injection molded polypropylene outer shell
- Injection molded polyethylene inner back shell designed with deep ribbing to provide extra support
- Upholstered back features 1" of custom molded foam

Guest Models

- Injection molded polypropylene inner and outer back panels
- Upholstered back features 1" of custom molded foam

BACK REST (Upholstered Back Models)

- Back height can be adjusted by simply lifting up on the back of upholstered back models
- The range of adjustment is approximately 3"

MESH

- 100% polypropylene
- Cleaning code: W
- 100,000+ double rubs

LUMBAR (Mesh Back Models)

- Lumbar on mesh back adjusts approximately 2¼" by simply lifting and lowering the lumbar pad
- Cannot be field installed to non-lumbar models

ARMS

- Encased uprights are made of reinforced nylon or polished aluminum
- Height adjustable arms adjust in height with a push button to one of eight positions within a 3" range
- Arms with width adjustment allow arms to adjust within a 2½" range
- Arms with depth adjustment allows arm pad to adjust within a 2" range
- Arm pads are soft black polyurethane
- Guest arms are black glass filled polypropylene

CONFERENCE ARMS

- Die cast polished aluminum
- Arm pads are soft black polyurethane

CONTROL MECHANISM

- Synchronous tilt control allows the back and seat to move in a synchronized 2.3:1 ratio motion
- Free float feature allows the chair to tilt freely
- The back angle can be locked in infinite position
- Standard pneumatic gas cylinder lift allow to raise and lower 6" and provides spring action for added comfort
- Seat slide option adjusts seat depth within a 2¼" range

BASE AND CASTERS

- Features a five-prong black glass filled nylon base or a polished cast aluminum base
- All bases have black, hard double wheel casters, which work on multiple surfaces
- Black, soft double wheel casters are available for use on hard floors; upcharge applies to this option

GLIDE

- Durable hard black nylon glides are standard
- Soft glides are available for an upcharge

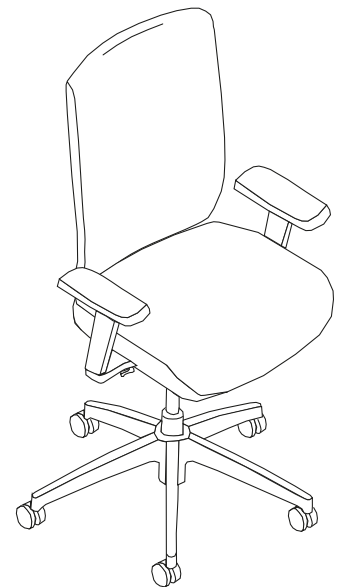
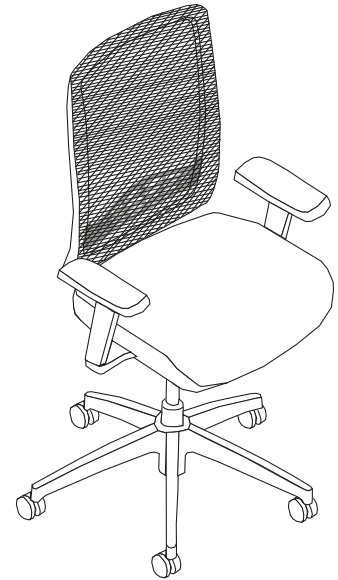

For comprehensive sustainability information that includes LEED® point contribution, visit NationalOfficeFurniture.ecoScorecard.com.

Please consult customer service for TB133 options.

CASTERS

All Models

- C3 Hard (standard)
- C4 Soft (add \$24 list)

GLIDES

For Task Stool Models

- C54 Hard (standard)
- C55 Soft (add \$24 list)

For Guest Models

- C53 Hard (standard)
- C52 Soft (add \$24 list)

To You In
10 DAYS
...or Less

Shaded model numbers are available on our "To You in 10 Days or Less" Quick Delivery program and will be delivered within 10 days.

To Order, Specify:

1. Model Number
2. Mesh Color
3. Fabric Grade / Cover Number
4. Caster or Glide

• See page 245 for Lavoro options

High Back Mesh Armless

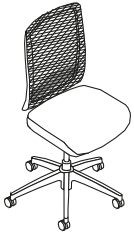

Model No.	Grade / List Price								
		1	2	3	4	6	7	L7	L8
N30HM1SP		\$ 667	685	694	707	747	780	937	988
N30HML1SP	Lumbar	742	760	769	782	822	855	1012	1063
N30HM1SSP	Seatslide	758	776	785	798	838	871	1028	1079
N30HML1SSP	Lumbar, Seatslide	833	851	860	873	913	946	1103	1154
N30HM1SN	Polished Aluminum	768	786	795	808	848	881	1038	1089
N30HML1SN	Lumbar, Polished Aluminum	843	861	870	883	923	956	1113	1164
N30HM1SSN	Seatslide, Polished Aluminum	859	877	886	899	939	972	1129	1180
N30HML1SSN	Lumbar, Seatslide, Polished Aluminum	934	952	961	974	1014	1047	1204	1255

Dimensions

Width	25¼	Seat Height	17½-23½	Seat Depth	17	Weight	52
Depth	25¼	Seat Height with Seatslide	18-24	Seat Depth with Seatslide	16½-18¾	Cubic Ft.	18.7
Depth with Seatslide	25¼-27¾	Seat Width	20¼	Back Height	25		
Height	43½-49¼			Back Width	17¾		

High Back Mesh Height, Arm Cap Depth



Quick Delivery Models: QN30HM2SSP

Model No.	Grade / List Price								
		1	2	3	4	6	7	L7	L8
N30HM2SP		\$ 768	786	795	808	848	881	1038	1089
N30HML2SP	Lumbar	843	861	870	883	923	956	1113	1164
N30HM2SSP	Seatslide	859	877	886	899	939	972	1129	1180
N30HML2SSP	Lumbar, Seatslide	934	952	961	974	1014	1047	1204	1255
N30HM2SN	Polished Aluminum	869	887	896	909	949	982	1139	1190
N30HML2SN	Lumbar, Polished Aluminum	944	962	971	984	1024	1057	1214	1265
N30HM2SSN	Seatslide, Polished Aluminum	960	978	987	1000	1040	1073	1230	1281
N30HML2SSN	Lumbar, Seatslide, Polished Aluminum	1035	1053	1062	1075	1115	1148	1305	1356

Dimensions

Width	26½	Arm Height	25½-31½	Seat Depth	17	Weight	52
Depth	25¼	Arm Width	19¼	Seat Depth with Seatslide	16½-18¾	Cubic Ft.	18.7
Depth with Seatslide	25¼-27¾	Seat Height	17½-23½	Back Height	25		
Height	43½-49¼	Seat Height with Seatslide	18-24	Back Width	17¾		
		Seat Width	20¼				

**High Back Mesh
Height, Width,
Arm Cap Depth**



Model No.

Grade / List Price

Quick Delivery Models: QN30HM3SSP

		1	2	3	4	6	7	L7	L8
N30HM3SP		\$ 818	836	845	858	898	931	1088	1139
N30HML3SP	Lumbar	894	912	921	934	974	1007	1164	1215
N30HM3SSP	Seatslide	909	927	936	949	989	1022	1179	1230
N30HML3SSP	Lumbar, Seatslide	985	1003	1012	1025	1065	1098	1255	1306
N30HM3SN	Polished Aluminum	919	937	946	959	999	1032	1189	1240
N30HML3SN	Lumbar, Polished Aluminum	995	1013	1022	1035	1075	1108	1265	1316
N30HM3SSN	Seatslide, Polished Aluminum	1010	1028	1037	1050	1090	1123	1280	1331
N30HML3SSN	Lumbar, Seatslide, Polished Aluminum	1086	1104	1113	1126	1166	1199	1356	1407

Dimensions

Width	28¼	Arm Height	25½-31½	Seat Depth	17	Weight	52
Depth	25¼	Arm Width	18¼-20½	Seat Depth with Seatslide	16½-18¾	Cubic Ft.	18.7
Depth with Seatslide	25¼-27¾	Seat Height	17½-23½	Back Height	25		
Height	43½-49¼	Seat Height with Seatslide	18-24	Back Width	17¾		
		Seat Width	20¼				

**High Back Mesh
Static Arms**



		1	2	3	4	6	7	L7	L8
N30HM9SP		\$ 717	735	744	757	797	830	987	1038
N30HML9SP	Lumbar	793	811	820	833	873	906	1063	1114
N30HM9SSP	Seatslide	808	826	835	848	888	921	1078	1129
N30HML9SSP	Lumbar, Seatslide	884	902	911	924	964	997	1154	1205
N30HM9SN	Polished Aluminum	818	836	845	858	898	931	1088	1139
N30HML9SN	Lumbar, Polished Aluminum	894	912	921	934	974	1007	1164	1215
N30HM9SSN	Seatslide, Polished Aluminum	909	927	936	949	989	1022	1179	1230
N30HML9SSN	Lumbar, Seatslide, Polished Aluminum	985	1003	1012	1025	1065	1098	1255	1306

Dimensions

Width	26½	Arm Height	27¾-33½	Seat Depth	17	Weight	52
Depth	25¼	Arm Width	19½	Seat Depth with Seatslide	16½-18¾	Cubic Ft.	18.7
Depth with Seatslide	25¼-27¾	Seat Height	17½-23½	Back Height	25		
Height	43½-49¼	Seat Height with Seatslide	18-24	Back Width	17¾		
		Seat Width	20¼				

**High Back Mesh
Conference Arms**



		1	2	3	4	6	7	L7	L8
N30HM8SN	Polished Aluminum	1020	1038	1047	1060	1100	1133	1290	1341
N30HML8SN	Lumbar, Polished Aluminum	1096	1114	1123	1136	1176	1209	1366	1417
N30HM8SSN	Seatslide, Polished Aluminum	1111	1129	1138	1151	1191	1224	1381	1432
N30HML8SSN	Lumbar, Seatslide, Polished Aluminum	1187	1205	1214	1227	1267	1300	1457	1508

Dimensions

Width	25½	Arm Height	27¾-33½	Seat Depth	17	Weight	52
Depth	25¼	Arm Width	20¼	Seat Depth with Seatslide	16½-18¾	Cubic Ft.	18.7
Depth with Seatslide	25¼-27¾	Seat Height	17½-23½	Back Height	25		
Height	43½-49¼	Seat Height with Seatslide	18-24	Back Width	17¾		
		Seat Width	20¼				

To You In
10
DAYS
...or Less

Shaded model numbers are available on our "To You in 10 Days or Less" Quick Delivery program and will be delivered within 10 days.

To Order, Specify:

1. Model Number
2. Fabric Grade / Cover Number
3. Caster or Glide

• See page 245 for Lavoro options

High Back Upholstered Armless

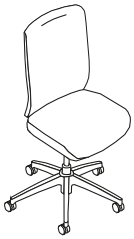

Model No.	Grade / List Price	Grade / List Price							
		1	2	3	4	6	7	L7	L8
N30HP1SP	Plastic Extreme Back	\$ 788	818	832	853	918	971	1227	1309
N30HP1SSP	Plastic Extreme Back, Seatslide	879	909	923	944	1009	1062	1318	1400
N30HP1SN	Plastic Extreme Back, Polished Aluminum	889	919	933	954	1019	1072	1328	1410
N30HP1SSN	Plastic Extreme Back, Seatslide, Polished Aluminum	980	1010	1024	1045	1110	1163	1419	1501
N30HU1SP	Upholstered Back, Plastic Base	838	873	889	913	988	1050	1345	1440
N30HU1SSP	Upholstered Back, Seatslide	929	964	980	1004	1079	1141	1436	1531
N30HU1SN	Upholstered Back, Polished Aluminum	939	974	990	1014	1089	1151	1446	1541
N30HU1SSN	Upholstered Back, Seatslide, Polished Aluminum	1030	1065	1081	1105	1180	1242	1537	1632

Dimensions

Width	25¼	Seat Height	17½-23½	Seat Depth	17	Weight	53
Depth	25¼	Seat Height with Seatslide	18-24	Seat Depth with Seatslide	16½-18¾	Cubic Ft.	18.7
Seatslide Height	25¼-27¾	Seat Width	20¼	Back Height	24¼-27		
	43½-49¼			Back Width	18¼		

• Contrasting fabric option – specify X (i.e., N30HP1SPX); see next page. For list pricing, use your electronic specification tool or contact customer service

High Back Upholstered Height, Arm Cap Depth



Quick Delivery Models: QN30HP2SSP

Model No.	Grade / List Price	Grade / List Price							
		1	2	3	4	6	7	L7	L8
N30HP2SP	Plastic Extreme Back	\$ 889	919	933	954	1019	1072	1328	1410
N30HP2SSP	Plastic Extreme Back, Seatslide	980	1010	1024	1045	1110	1163	1419	1501
N30HP2SN	Plastic Extreme Back, Polished Aluminum	990	1020	1034	1055	1120	1173	1429	1511
N30HP2SSN	Plastic Extreme Back, Seatslide, Polished Aluminum	1081	1111	1125	1146	1211	1264	1520	1602
N30HU2SP	Upholstered Back, Plastic Base	939	974	990	1014	1089	1151	1446	1541
N30HU2SSP	Upholstered Back, Seatslide	1030	1065	1081	1105	1180	1242	1537	1632
N30HU2SN	Upholstered Back, Polished Aluminum	1040	1075	1091	1115	1190	1252	1547	1642
N30HU2SSN	Upholstered Back, Seatslide, Polished Aluminum	1131	1166	1182	1206	1281	1343	1638	1733

Dimensions

Width	26½	Arm Height	25⅝-31⅝	Seat Depth	17	Weight	53
Depth	25¼	Arm Width	19¼	Seat Depth with Seatslide	16½-18¾	Cubic Ft.	18.7
Seatslide Height	25¼-27¾	Seat Height	17½-23½	Back Height	24¼-27		
	43½-49¼	Seat Height with Seatslide	18-24	Back Width	18¼		
		Seat Width	20¼				

• Contrasting fabric option – specify X (i.e., N30HP2SPX); see next page. For list pricing, use your electronic specification tool or contact customer service

High Back Upholstered Height, Width, Arm Cap Depth



Model No.

Grade / List Price

Quick Delivery Models: QN30HP3SSP

		1	2	3	4	6	7	L7	L8
N30HP3SP	Plastic Extreme Back	\$ 939	969	983	1004	1069	1122	1378	1460
N30HP3SSP	Plastic Extreme Back, Seatslide	1030	1060	1074	1095	1160	1213	1469	1551
N30HP3SN	Plastic Extreme Back, Polished Aluminum	1040	1070	1084	1105	1170	1223	1479	1561
N30HP3SSN	Plastic Extreme Back, Seatslide, Polished Aluminum	1131	1161	1175	1196	1261	1314	1570	1652
N30HU3SP	Upholstered Back	990	1025	1041	1065	1140	1202	1497	1592
N30HU3SSP	Upholstered Back, Seatslide	1081	1116	1132	1156	1231	1293	1588	1683
N30HU3SN	Upholstered Back, Polished Aluminum	1091	1126	1142	1166	1241	1303	1598	1693
N30HU3SSN	Upholstered Back, Seatslide, Polished Aluminum	1182	1217	1233	1257	1332	1394	1689	1784

Dimensions

Width	25½	Arm Height	25¾-31¼	Seat Depth	17	Weight	53
Depth	25¼	Arm Width	18¼-20½	Seat Depth with Seatslide	16½-18¾	Cubic Ft.	18.7
Depth with Seatslide	25½-27¾	Seat Height	17½-23½	Back Height	24¼-27		
Height	43½-49¼	Seat Height with Seatslide	18-24	Back Width	18¼		
		Seat Width	20¼				

• Contrasting fabric option – specify X (i.e., N30HP3SPX); see below. For list pricing, use your electronic specification tool or contact customer service

High Back Upholstered Static Arms



		1	2	3	4	6	7	L7	L8
N30HP9SP	Plastic Extreme Back	\$ 838	868	882	903	968	1021	1277	1359
N30HP9SSP	Plastic Extreme Back, Seatslide	929	959	973	994	1059	1112	1368	1450
N30HP9SN	Plastic Extreme Back, Polished Aluminum	939	969	983	1004	1069	1122	1378	1460
N30HP9SSN	Plastic Extreme Back, Seatslide, Polished Aluminum	1030	1060	1074	1095	1160	1213	1469	1551
N30HU9SP	Upholstered Back	889	924	940	964	1039	1101	1396	1491
N30HU9SSP	Upholstered Back, Seatslide	980	1015	1031	1055	1130	1192	1487	1582
N30HU9SN	Upholstered Back, Polished Aluminum	990	1025	1041	1065	1140	1202	1497	1592
N30HU9SSN	Upholstered Back, Seatslide, Polished Aluminum	1081	1116	1132	1156	1231	1293	1588	1683

Dimensions

Width	25½	Arm Height	27¾-33½	Seat Depth	17	Weight	53
Depth	25¼	Arm Width	19½	Seat Depth with Seatslide	16½-18¾	Cubic Ft.	18.7
Depth with Seatslide	25½-27¾	Seat Height	17½-23½	Back Height	24¼-27		
Height	43½-49¼	Seat Height with Seatslide	18-24	Back Width	18¼		
		Seat Width	20¼				

• Contrasting fabric option – specify X (i.e., N30HP9SPX); see below. For list pricing, use your electronic specification tool or contact customer service

To Order Contrasting Fabric, Specify:

1. Model Number plus "X"
2. Back Fabric Grade Number/Cover Number
3. Extreme Back Fabric Grade Number/Cover Number (when applicable)
4. Seat Fabric Grade Number/Cover Number
5. Caster or Glide

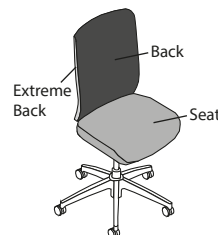

Contrasting Fabric

To You In
10
DAYS
...or Less

Shaded model numbers are available on our "To You in 10 Days or Less" Quick Delivery program and will be delivered within 10 days.

To Order, Specify:

1. Model Number
 2. Fabric Grade / Cover Number
 3. Caster or Glide
- See page 245 for Lavoro options

High Back Upholstered Conference Arms



Model No.	Grade / List Price	Grade / List Price							
		1	2	3	4	6	7	L7	L8
N30HP8SN	Plastic Extreme Back, Polished Aluminum	\$ 1141	1171	1185	1206	1271	1324	1580	1662
N30HP8SSN	Plastic Extreme Back, Seatslide, Polished Aluminum	1232	1262	1276	1297	1362	1415	1671	1753
N30HU8SN	Upholstered Back, Polished Aluminum	1192	1227	1243	1267	1342	1404	1699	1794
N30HU8SSN	Upholstered Back, Seatslide, Polished Aluminum	1283	1318	1334	1358	1433	1495	1790	1885

Dimensions

Width	25½	Arm Height	27¾-33½	Seat Depth	16½	Weight	53
Depth	25¼	Arm Width	20¼	Seat Depth with		Cubic Ft.	18.7
Depth with		Seat Height	17½-23½	Seatslide	16½-18¾		
Seatslide	25½-27¾	Seat Height with		Back Height	24¼-27		
Height	43½-49¼	Seatslide	18-24	Back Width	18¼		
		Seat Width	20¼				

• Contrasting fabric option – specify X (i.e., N30HP8SNX); see next page. For list pricing, use your electronic specification tool or contact customer service

Mid Back Upholstered Armless

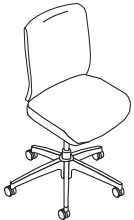

Model No.	Grade / List Price	Grade / List Price							
		1	2	3	4	6	7	L7	L8
N30MP1SP	Plastic Extreme Back	\$ 742	770	783	802	862	911	1148	1223
N30MP1SSP	Plastic Extreme Back, Seatslide	833	861	874	893	953	1002	1239	1314
N30MP1SN	Plastic Extreme Back, Polished Aluminum	843	871	884	903	963	1012	1249	1324
N30MP1SSN	Plastic Extreme Back, Seatslide, Polished Aluminum	934	962	975	994	1054	1103	1340	1415
N30MU1SP	Upholstered Back	793	825	841	863	933	990	1266	1354
N30MU1SSP	Upholstered Back, Seatslide	884	916	932	954	1024	1081	1357	1445
N30MU1SN	Upholstered Back, Polished Aluminum	894	926	942	964	1034	1091	1367	1455
N30MU1SSN	Upholstered Back, Seatslide, Polished Aluminum	985	1017	1033	1055	1125	1182	1458	1546

Dimensions

Width	25¼	Seat Height	17½-23½	Seat Depth	16½	Weight	50
Depth	25¼	Seat Height with		Seat Depth with		Cubic Ft.	16.3
Depth with		Seatslide	18-24	Seatslide	16½-18¾		
Seatslide	25½-27¾	Seat Width	20¼	Back Height	22¼-24¾		
Height	40½-46¼			Back Width	18		

• Contrasting fabric option – specify X (i.e., N30MP1SPX); see next page. For list pricing, use your electronic specification tool or contact customer service

Mid Back Upholstered Height, Arm Cap Depth



Model No.

Grade / List Price

Quick Delivery Models: QN30MP2SSP

		1	2	3	4	6	7	L7	L8
N30MP2SP	Plastic Extreme Back	\$ 843	871	884	903	963	1012	1249	1324
N30MP2SSP	Plastic Extreme Back, Seatslide	934	962	975	994	1054	1103	1340	1415
N30MP2SN	Plastic Extreme Back, Polished Aluminum	944	972	985	1004	1064	1113	1350	1425
N30MP2SSN	Plastic Extreme Back, Seatslide, Polished Aluminum	1035	1063	1076	1095	1155	1204	1441	1516
N30MU2SP	Upholstered Back	894	926	942	964	1034	1091	1367	1455
N30MU2SSP	Upholstered Back, Seatslide	985	1017	1033	1055	1125	1182	1458	1546
N30MU2SN	Upholstered Back, Polished Aluminum	995	1027	1043	1065	1135	1192	1468	1556
N30MU2SSN	Upholstered Back, Seatslide, Polished Aluminum	1086	1118	1134	1156	1226	1283	1559	1647

Dimensions

Width	26½	Arm Height	27½-33½	Seat Depth	16½	Weight	50
Depth	25¼	Arm Width	19½	Seat Depth with		Cubic Ft.	16.3
Depth with		Seat Height	17½-23½	Seatslide	16½-18¾		
Seatslide	25¼-27¾	Seat Height with		Back Height	22¼-24¾		
Height	40½-46¼	Seatslide	18-24	Back Width	18		
		Seat Width	20¼				

• Contrasting fabric option – specify X (i.e., N30MP2SPX); see below. For list pricing, use your electronic specification tool or contact customer service

Mid Back Upholstered Height, Width, Arm Cap Depth



Quick Delivery Models: QN30MP3SSP

		1	2	3	4	6	7	L7	L8
N30MP3SP	Plastic Extreme Back	\$ 894	922	935	954	1014	1063	1300	1375
N30MP3SSP	Plastic Extreme Back, Seatslide	985	1013	1026	1045	1105	1154	1391	1466
N30MP3SN	Plastic Extreme Back, Polished Aluminum	995	1023	1036	1055	1115	1164	1401	1476
N30MP3SSN	Plastic Extreme Back, Seatslide, Polished Aluminum	1086	1114	1127	1146	1206	1255	1492	1567
N30MU3SP	Upholstered Back	944	976	992	1014	1084	1141	1417	1505
N30MU3SSP	Upholstered Back, Seatslide	1035	1067	1083	1105	1175	1232	1508	1596
N30MU3SN	Upholstered Back, Polished Aluminum	1045	1077	1093	1115	1185	1242	1518	1606
N30MU3SSN	Upholstered Back, Seatslide, Polished Aluminum	1136	1168	1184	1206	1276	1333	1609	1697

Dimensions

Width	26½	Arm Height	25½-31½	Seat Depth	16½	Weight	50
Depth	25¼	Arm Width	18¼-20½	Seat Depth with		Cubic Ft.	16.3
Depth with		Seat Height	17½-23½	Seatslide	16½-18¾		
Seatslide	25¼-27¾	Seat Height with		Back Height	22¼-24¾		
Height	40½-46¼	Seatslide	18-24	Back Width	18		
		Seat Width	20¼				

• Contrasting fabric option – specify X (i.e., N30MP3SPX); see below. For list pricing, use your electronic specification tool or contact customer service

To Order Contrasting Fabric, Specify:

1. Model Number plus "X"
2. Back Fabric Grade Number/Cover Number
3. Extreme Back Fabric Grade Number/Cover Number (when applicable)
4. Seat Fabric Grade Number/Cover Number
5. Caster or Glide

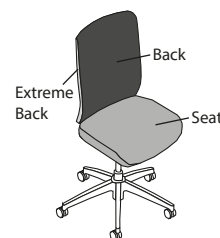

Contrasting Fabric

Lavoro

To Order, Specify:

1. Model Number
2. Fabric Grade / Cover Number
3. Caster or Glide

• See page 245 for Lavoro options

Mid Back Upholstered Static Arms



Model No.	Grade / List Price	Grade / List Price							
		1	2	3	4	6	7	L7	L8
N30MP9SP	Plastic Extreme Back	\$ 793	821	834	853	913	962	1199	1274
N30MP9SSP	Plastic Extreme Back, Seatslide	884	912	925	944	1004	1053	1290	1365
N30MP9SN	Plastic Extreme Back, Polished Aluminum	894	922	935	954	1014	1063	1300	1375
N30MP9SSN	Plastic Extreme Back, Seatslide, Polished Aluminum	985	1013	1026	1045	1105	1154	1391	1466
N30MU9SP	Upholstered Back	843	875	891	913	983	1040	1316	1404
N30MU9SSP	Upholstered Back, Seatslide	934	966	982	1004	1074	1131	1407	1495
N30MU9SN	Upholstered Back, Polished Aluminum	944	976	992	1014	1084	1141	1417	1505
N30MU9SSN	Upholstered Back, Seatslide, Polished Aluminum	1035	1067	1083	1105	1175	1232	1508	1596

Dimensions

Width	26½	Arm Height	27¾-33½	Seat Depth	16½	Weight	50
Depth	25¼	Arm Width	19½	Seat Depth with		Cubic Ft.	16.3
Depth with		Seat Height	17½-23½	Seatslide	16½-18¾		
Seatslide	25¼-27¾	Seat Height with		Back Height	22¼-24¾		
Height	40½-46¼	Seatslide	18-24	Back Width	18		
		Seat Width	20¼				

- Contrasting fabric option – specify X (i.e., N30MP9SPX); see next page. For list pricing, use your electronic specification tool or contact customer service

Mid Back Upholstered Conference Arms



Model No.	Grade / List Price	Grade / List Price							
		1	2	3	4	6	7	L7	L8
N30MP8SN	Plastic Extreme Back, Polished Aluminum	\$ 1096	1124	1137	1156	1216	1265	1502	1577
N30MP8SSN	Plastic Extreme Back, Seatslide, Polished Aluminum	1187	1215	1228	1247	1307	1356	1593	1668
N30MU8SN	Upholstered Back, Polished Aluminum	1146	1178	1194	1216	1286	1343	1619	1707
N30MU8SSN	Upholstered Back, Seatslide, Polished Aluminum	1237	1269	1285	1307	1377	1434	1710	1798

Dimensions

Width	25½	Arm Height	27¾-33½	Seat Depth	16½	Weight	50
Depth	25¼	Arm Width	20¼	Seat Depth with		Cubic Ft.	16.3
Depth with		Seat Height	17½-23½	Seatslide	16½-18¾		
Seatslide	25¼-27¾	Seat Height with		Back Height	22¼-24¾		
Height	40½-46¼	Seatslide	18-24	Back Width	18		
		Seat Width	20¼				

- Contrasting fabric option – specify X (i.e., N30MP8SNX); see next page. For list pricing, use your electronic specification tool or contact customer service

Stool Mid Back Upholstered Armless

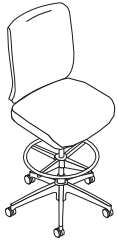

Mobile

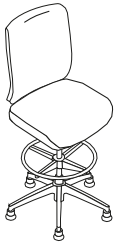

Static

Model No.	Grade / List Price									
		1	2	3	4	6	7	L7	L8	
N30SP1SP	Plastic Extreme Back	\$ 768	796	809	828	888	937	1174	1249	
N30SP1SPG	Plastic Extreme Back, Glides	768	796	809	828	888	937	1174	1249	
N30SP1SN	Plastic Extreme Back, Polished Aluminum	869	897	910	929	989	1038	1275	1350	
N30SP1SNG	Plastic Extreme Back, Polished Aluminum, Glides	869	897	910	929	989	1038	1275	1350	
N30SU1SP	Upholstered Back	843	875	891	913	983	1040	1316	1404	
N30SU1SPG	Upholstered Back, Glides	843	875	891	913	983	1040	1316	1404	
N30SU1SN	Upholstered Back, Polished Aluminum	944	976	992	1014	1084	1141	1417	1505	
N30SU1SNG	Upholstered Back, Polished Aluminum, Glides	944	976	992	1014	1084	1141	1417	1505	

Dimensions

Width	25¼	Seat Height	21½-29%	Back Height	22¼-24¾	Weight	60
Depth	25¼	Seat Depth	16½	Back Width	18	Cubic Ft.	18.7
Height	43¼-54	Seat Width	20¼				

• Contrasting fabric option – specify X (i.e., N30SP1SPX); see below. For list pricing, use your electronic specification tool or contact customer service

Stool Mid Back Upholstered Height, Arm Cap Depth

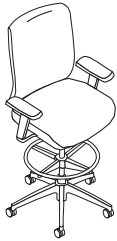

Mobile



Static

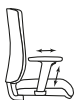

Model No.	Grade / List Price									
		1	2	3	4	6	7	L7	L8	
N30SP2SP	Plastic Extreme Back	\$ 869	897	910	929	989	1038	1275	1350	
N30SP2SPG	Plastic Extreme Back, Glides	869	897	910	929	989	1038	1275	1350	
N30SP2SN	Plastic Extreme Back, Polished Aluminum	970	998	1011	1030	1090	1139	1376	1451	
N30SP2SNG	Plastic Extreme Back, Polished Aluminum, Glides	970	998	1011	1030	1090	1139	1376	1451	
N30SU2SP	Upholstered Back	944	976	992	1014	1084	1141	1417	1505	
N30SU2SPG	Upholstered Back, Glides	944	976	992	1014	1084	1141	1417	1505	
N30SU2SN	Upholstered Back, Polished Aluminum	1045	1077	1093	1115	1185	1242	1518	1606	
N30SU2SNG	Upholstered Back, Polished Aluminum, Glides	1045	1077	1093	1115	1185	1242	1518	1606	

Dimensions

Width	26½	Seat Height	21½-29%	Arm Height	28-39	Weight	60
Depth	25¼	Seat Depth	16½	Arm Width	19%	Cubic Ft.	18.7
Height	43¼-54	Seat Width	20¼	Back Height	22¼-24¾		
				Back Width	18		

• Contrasting fabric option – specify X (i.e., N30SP2SPX); see below. For list pricing, use your electronic specification tool or contact customer service

To Order Contrasting Fabric, Specify:

1. Model Number plus "X"
2. Back Fabric Grade Number/Cover Number
3. Extreme Back Fabric Grade Number/Cover Number (when applicable)
4. Seat Fabric Grade Number/Cover Number
5. Caster or Glide

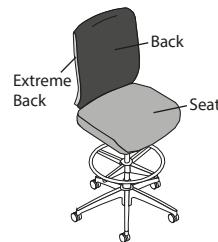

Contrasting Fabric

Lavoro

To Order, Specify:

1. Model Number
2. Fabric Grade / Cover Number
3. Caster or Glide

- See page 245 for Lavoro options

**Stool Mid Back
Upholstered
Height, Width,
Arm Cap Depth**

Mobile

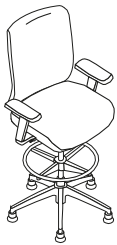

Static



Model No.	Grade / List Price	Grade / List Price							
		1	2	3	4	6	7	L7	L8
N30SP3SP	Plastic Extreme Back	\$ 919	947	960	979	1039	1088	1325	1400
N30SP3SPG	Plastic Extreme Back, Glides	919	947	960	979	1039	1088	1325	1400
N30SP3SN	Plastic Extreme Back, Polished Aluminum	1020	1048	1061	1080	1140	1189	1426	1501
N30SP3SNG	Plastic Extreme Back, Polished Aluminum, Glides	1020	1048	1061	1080	1140	1189	1426	1501
N30SU3SP	Upholstered Back	995	1027	1043	1065	1135	1192	1468	1556
N30SU3SPG	Upholstered Back, Glides	995	1027	1043	1065	1135	1192	1468	1556
N30SU3SN	Upholstered Back, Polished Aluminum	1096	1128	1144	1166	1236	1293	1569	1657
N30SU3SNG	Upholstered Back, Polished Aluminum, Glides	1096	1128	1144	1166	1236	1293	1569	1657

Dimensions

Width	26½	Seat Height	21½-29¾	Arm Height	28-39	Weight	60
Depth	25¼	Seat Depth	16½	Arm Width	18¼-20½	Cubic Ft.	18.7
Height	43¼-54	Seat Width	20¼	Back Height	22¼-24¾		
				Back Width	18		

- Contrasting fabric option – specify X (i.e., N30SP3SPX); see next page. For list pricing, use your electronic specification tool or contact customer service

Stool Mid Back Upholstered Static Arms



Mobile

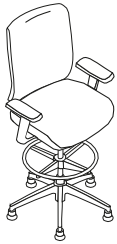

Static



Model No.		Grade / List Price							
		1	2	3	4	6	7	L7	L8
N30SP9SP	Plastic Extreme Back	\$ 818	846	859	878	938	987	1224	1299
N30SP9SPG	Plastic Extreme Back, Glides	818	846	859	878	938	987	1224	1299
N30SP9SN	Plastic Extreme Back, Polished Aluminum	919	947	960	979	1039	1088	1325	1400
N30SP9SNG	Plastic Extreme Back, Polished Aluminum, Glides	919	947	960	979	1039	1088	1325	1400
N30SU9SP	Upholstered Back	894	926	942	964	1034	1091	1367	1455
N30SU9SPG	Upholstered Back, Glides	894	926	942	964	1034	1091	1367	1455
N30SU9SN	Upholstered Back, Polished Aluminum	995	1027	1043	1065	1135	1192	1468	1556
N30SU9SNG	Upholstered Back, Polished Aluminum, Glides	995	1027	1043	1065	1135	1192	1468	1556

Dimensions

Width	26½	Seat Height	21½-29¾	Arm Height	30½-38½	Weight	60
Depth	25¼	Seat Depth	16½	Arm Width	19½	Cubic Ft.	18.7
Height	43¼-54	Seat Width	20¼	Back Height	22¼-24¾		
				Back Width	18		

- Contrasting fabric option – specify X (i.e., N30SP9SPX); see below. For list pricing, use your electronic specification tool or contact customer service

Stool Mid Back Upholstered Conference Arms

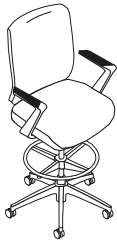

Mobile

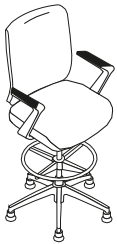

Static



Model No.		Grade / List Price							
		1	2	3	4	6	7	L7	L8
N30SP8SN	Plastic Extreme Back, Polished Aluminum	\$ 1121	1149	1162	1181	1241	1290	1527	1602
N30SP8SNG	Plastic Extreme Back, Polished Aluminum, Glides	1121	1149	1162	1181	1241	1290	1527	1602
N30SU8SN	Upholstered Back, Polished Aluminum	1197	1229	1245	1267	1337	1394	1670	1758
N30SU8SNG	Upholstered Back, Polished Aluminum, Glides	1197	1229	1245	1267	1337	1394	1670	1758

Dimensions

Width	26½	Seat Height	21½-29¾	Arm Height	30½-38½	Weight	60
Depth	25¼	Seat Depth	16½	Arm Width	20½	Cubic Ft.	18.7
Height	43¼-54	Seat Width	20¼	Back Height	22¼-24¾		
				Back Width	18		

- Contrasting fabric option – specify X (i.e., N30SP8SNX); see below. For list pricing, use your electronic specification tool or contact customer service

To Order Contrasting Fabric, Specify:

1. Model Number plus "X"
2. Back Fabric Grade Number/Cover Number
3. Extreme Back Fabric Grade Number/Cover Number (when applicable)
4. Seat Fabric Grade Number/Cover Number
5. Caster or Glide

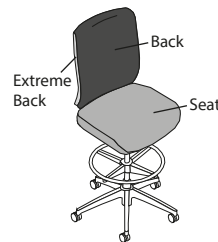

Contrasting Fabric

To You In
10 DAYS
...or Less

Shaded model numbers are available on our "To You in 10 Days or Less" Quick Delivery program and will be delivered within 10 days.

To Order, Specify:

1. Model Number
2. Mesh Color (when applicable)
3. Fabric Grade / Cover Number
4. Caster or Glide

• See page 245 for Lavoro options

Guest Mesh Back Armless



Upholstered Seat Static



Plastic Seat Mobile

Model No.

Grade / List Price

Quick Delivery Models: QN30GM1UN, QN30GM1UNC

		1	2	3	4	6	7	L7	L8
N30GM1PP	Plastic Seat, Static, Black	\$ 455							
N30GM1PPC	Plastic Seat, Mobile, Black	455							
N30GM1PN	Plastic Seat, Static, Polished Aluminum	480							
N30GM1PNC	Plastic Seat, Mobile, Polished Aluminum	480							
N30GM1UP	Upholstered Seat, Static, Black	505	526	536	550	595	632	809	866
N30GM1UPC	Upholstered Seat, Mobile, Black	505	526	536	550	595	632	809	866
N30GM1UN	Upholstered Seat, Static, Polished Aluminum	530	551	561	575	620	657	834	891
N30GM1UNC	Upholstered Seat, Mobile, Polished Aluminum	530	551	561	575	620	657	834	891

Dimensions

Width	21¼	Seat Height	18½	Back Height	16½	Weight	29
Depth	22¼	Seat Depth	17½	Back Width	18	Cubic Ft.	16.7
Height	33	Seat Width	18½				

Guest Mesh Back Arms

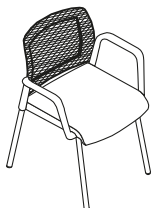

Upholstered Seat Static



Plastic Seat Mobile

Quick Delivery Models: QN30GM9UP, QN30GM9UPC

		1	2	3	4	6	7	L7	L8
N30GM9PP	Plastic Seat, Static, Black	\$ 505							
N30GM9PPC	Plastic Seat, Mobile, Black	505							
N30GM9PN	Plastic Seat, Static, Polished Aluminum	530							
N30GM9PNC	Plastic Seat, Mobile, Polished Aluminum	530							
N30GM9UP	Upholstered Seat, Static, Black	556	577	587	601	646	683	860	917
N30GM9UPC	Upholstered Seat, Mobile, Black	556	577	587	601	646	683	860	917
N30GM9UN	Upholstered Seat, Static, Polished Aluminum	581	602	612	626	671	708	885	942
N30GM9UNC	Upholstered Seat, Mobile, Polished Aluminum	581	602	612	626	671	708	885	942

Dimensions

Width	25¼	Seat Height	18½	Arm Height	27	Weight	29
Depth	22¼	Seat Depth	17½	Arm Width	21½	Cubic Ft.	16.7
Height	33	Seat Width	18½	Back Height	16½		
				Back Width	18		

Guest Upholstered Back Armless



Upholstered Seat Static

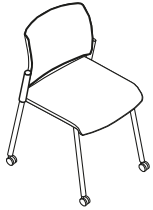

Plastic Seat Mobile

Model No.		Grade / List Price									
		1	2	3	4	6	7	L7	L8		
N30GP1PP	Plastic Seat, Static, Black	\$ 505	519	525	535	565	590	708	746		
N30GP1PPC	Plastic Seat, Mobile, Black	505	519	525	535	565	590	708	746		
N30GP1PN	Plastic Seat, Static, Polished Aluminum	530	544	550	560	590	615	733	771		
N30GP1PNC	Plastic Seat, Mobile, Polished Aluminum	530	544	550	560	590	615	733	771		
N30GP1UP	Upholstered Seat, Static, Black	556	577	587	601	646	683	860	917		
N30GP1UPC	Upholstered Seat, Mobile, Black	556	577	587	601	646	683	860	917		
N30GP1UN	Upholstered Seat, Static, Polished Aluminum	581	602	612	626	671	708	885	942		
N30GP1UNC	Upholstered Seat, Mobile, Polished Aluminum	581	602	612	626	671	708	885	942		

Dimensions

Width	21¼	Seat Height	18½	Back Height	16½	Weight	29
Depth	22¼	Seat Depth	17½	Back Width	18	Cubic Ft.	16.7
Height	33	Seat Width	18½				

• Contrasting fabric option – specify X (i.e., N30GP1UPX); see below. For list pricing, use your electronic specification tool or contact customer service

Guest Upholstered Back Arms



Upholstered Seat Static

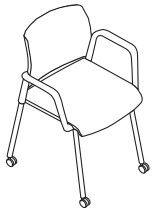

Plastic Seat Mobile

Quick Delivery Models: QN30GP9UP, QN30GP9UPC

Model No.		Grade / List Price									
		1	2	3	4	6	7	L7	L8		
N30GP9PP	Plastic Seat, Static, Black	\$ 556	570	576	586	616	641	759	797		
N30GP9PPC	Plastic Seat, Mobile, Black	556	570	576	586	616	641	759	797		
N30GP9PN	Plastic Seat, Static, Polished Aluminum	581	595	601	611	641	666	784	822		
N30GP9PNC	Plastic Seat, Mobile, Polished Aluminum	581	595	601	611	641	666	784	822		
N30GP9UP	Upholstered Seat, Static, Black	606	627	637	651	696	733	910	967		
N30GP9UPC	Upholstered Seat, Mobile, Black	606	627	637	651	696	733	910	967		
N30GP9UN	Upholstered Seat, Static, Polished Aluminum	631	652	662	676	721	758	935	992		
N30GP9UNC	Upholstered Seat, Mobile, Polished Aluminum	631	652	662	676	721	758	935	992		

Dimensions

Width	25¼	Seat Height	18½	Arm Height	27	Weight	29
Depth	22¼	Seat Depth	17½	Arm Width	21½	Cubic Ft.	16.7
Height	33	Seat Width	18½	Back Height	16½		
				Back Width	18		

• Contrasting fabric option – specify X (i.e., N30GP9UPX); see below. For list pricing, use your electronic specification tool or contact customer service

To Order Contrasting Fabric, Specify:

1. Model Number plus "X"
2. Back Fabric Grade Number/Cover Number
3. Seat Fabric Grade Number/Cover Number
4. Caster or Glide

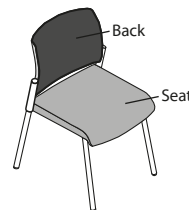

Contrasting Fabric

To You In
10 DAYS
...or Less

Shaded model numbers are available on our "To You in 10 Days or Less" Quick Delivery program and will be delivered within 10 days.

To Order, Specify:

1. Model Number
 2. Fabric Grade / Cover Number
 3. Caster or Glide
- See page 245 for Lavoro options

Guest Fully Upholstered Back Armless



Upholstered Seat Static



Plastic Seat Mobile

Model No. Grade / List Price

Quick Delivery Models: QN30GU1UN, QN30GU1UNC

		1	2	3	4	6	7	L7	L8
N30GU1PP	Plastic Seat, Static, Black	\$ 556	570	576	586	616	641	759	797
N30GU1PPC	Plastic Seat, Mobile, Black	556	570	576	586	616	641	759	797
N30GU1PN	Plastic Seat, Static, Polished Aluminum	581	595	601	611	641	666	784	822
N30GU1PNC	Plastic Seat, Mobile, Polished Aluminum	581	595	601	611	641	666	784	822
N30GU1UP	Upholstered Seat, Static, Black	606	627	637	651	696	733	910	967
N30GU1UPC	Upholstered Seat, Mobile, Black	606	627	637	651	696	733	910	967
N30GU1UN	Upholstered Seat, Static, Polished Aluminum	631	652	662	676	721	758	935	992
N30GU1UNC	Upholstered Seat, Mobile, Polished Aluminum	631	652	662	676	721	758	935	992

Dimensions

Width	21¼	Seat Height	18½	Back Height	16½	Weight	29
Depth	22¼	Seat Depth	17½	Back Width	18	Cubic Ft.	16.7
Height	33	Seat Width	18½				

- Contrasting fabric option – specify X (i.e., N30GU1UPX); see next page. For list pricing, use your electronic specification tool or contact customer service

Guest Fully Upholstered Back Arms



Upholstered Seat Static

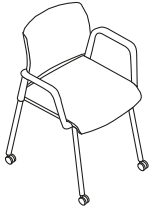

Plastic Seat Mobile

Model No.

Grade / List Price

Quick Delivery Models: QN30GU9UP, QN30GU9UPC

		1	2	3	4	6	7	L7	L8
N30GU9PP	Plastic Seat, Static, Black	\$ 606	620	626	636	666	691	809	847
N30GU9PPC	Plastic Seat, Mobile, Black	606	620	626	636	666	691	809	847
N30GU9PN	Plastic Seat, Static, Polished Aluminum	631	645	651	661	691	716	834	872
N30GU9PNC	Plastic Seat, Mobile, Polished Aluminum	631	645	651	661	691	716	834	872
N30GU9UP	Upholstered Seat, Static, Black	657	678	688	702	747	784	961	1018
N30GU9UPC	Upholstered Seat, Mobile, Black	657	678	688	702	747	784	961	1018
N30GU9UN	Upholstered Seat, Static, Polished Aluminum	682	703	713	727	772	809	986	1043
N30GU9UNC	Upholstered Seat, Mobile, Polished Aluminum	682	703	713	727	772	809	986	1043

Dimensions

Width	25¼	Seat Height	18½	Arm Height	27	Weight	29
Depth	22¼	Seat Depth	17½	Arm Width	21½	Cubic Ft.	16.7
Height	33	Seat Width	18½	Back Height	16½		
				Back Width	18		

- Contrasting fabric option – specify X (i.e., N30GU9PPX); see below. For list pricing, use your electronic specification tool or contact customer service

To Order Contrasting Fabric, Specify:

1. Model Number plus “X”
2. Back Fabric Grade Number/Cover Number
3. Extreme Back Fabric Grade Number/Cover Number (when applicable)
4. Seat Fabric Grade Number/Cover Number
5. Caster or Glide

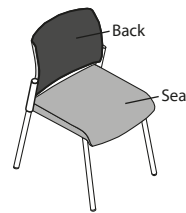

Contrasting Fabric Front View

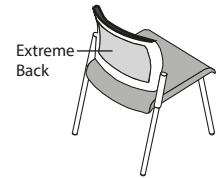

Back View

Medalist™

Medalist

MEDALIST PRODUCT SPECIFICATIONS

67/68/69 Series

FRAME CONSTRUCTION

- Double doweled joints with corner blocks are securely glued for maximum joint stability
- Guest models feature non-marring nylon glides

SEAT SUSPENSION

- Solid molded plywood panels are covered with 3" of high grade polyurethane foam

BACK CONSTRUCTION

- Solid molded plywood panels are covered with 3" of high grade polyurethane foam

CONTROL MECHANISM/LIFT

- The standard knee tilt mechanism features a heavy-duty adjustable tension spring for a variety of body sizes and minimal rise of front seat edge. This allows user's feet to remain planted when chair is in reclined position.
- The combination gas lift/tilt lock lever allows dual function with simple in/out movement for lockout and up/down movement for height adjustment

BASE AND CASTERS

- Wood base features a standard five-prong, rigid steel understructure to ensure a long life
- Decorative hardwood caps complement the chair design
- Black five-prong steel constructed base features a one piece polypropylene overlay for durability and a long life
- Caster posts fit directly into steel sleeves, greatly reducing caster socket failure
- Both wood and nylon bases have black, hard double wheel casters, which work on multiple surfaces
- Black, soft double wheel casters are available for use on hard floors; upcharge applies to this option
- All National bases are tested to BIFMA standards using 2500 lb. force

JURY BASE

- Pneumatic jury base
- Memory return swivel



FINISH

- Wood models feature a catalyzed top coat which resists denting, peeling and reactions to chemicals
- Can be cleaned with a damp cloth
- Features our silver ion antimicrobial finish which inhibits the growth of bacteria and microbes

WOOD SPECIES

- Hard maple

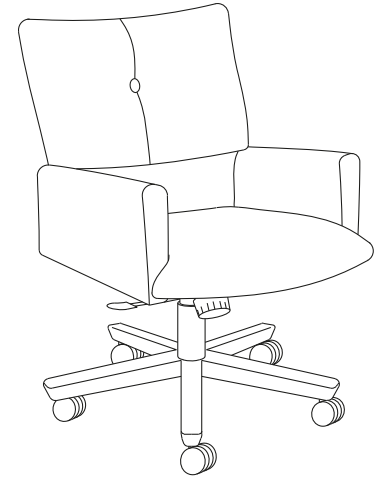

All Medalist models may be ordered to meet TB133 fire code.

To order seating to meet the TB133 fire code, specify an "F" at the end of the model number (Ex: N67CCCF).

Reference pages 465-493 for TB133 Fabric Matrix and pricing.

Please consult customer service for applicable Arc-Com, COM, Maharam, Momentum, Stinson or Ultrafabrics fabric.



For comprehensive sustainability information that includes LEED® point contribution, visit NationalOfficeFurniture.ecoScorecard.com.

FABRICS

Grade 1 American Graffiti
Cali
Plush
Ridge
Speedway
Stardust

Grade 2 Cathedral
COM
Orbit
Pixie
Sedona
Shenanigans
Spectrum
Strand
Tranquility
Twilight

Grade 3 Boardwalk
COL
Jacks
Pop Rocks

Grade 4 Big City
Bumble
Connect Four
Echo
Silvertex

Grade 6 Essence/Ultraleather
Flock
Scribe

Grade 7 Brisa
Brisa Distressed
Promessa
Silica

Grade L7 Davenport

Grade L8 Showcase

FINISHES

IM	Brighton	CW	Cordovan
NM	Natural	DW	Judicial
HN	Honey	MH	Mocha
CL	Caramel	405	Designer White
TF	Truffle	462	Cinder
AC	Autumn	792	Sable
MC	Amber	793	Acorn

CASTERS

For Wood Base

C3 Hard (standard)
C4 Soft (add \$24 list)

For Plastic Base

C1 Hard (standard)
C2 Soft (add \$24 list)

To Order, Specify:

1. Model Number
2. Fabric Grade Number
3. Cover Number
4. Finish Designator
5. Casters

• See page 263 for Medalist options

Contemporary High Back



Model No.	Grade / List Price							
	1	2/COM	3/COL	4	6	7	L7	L8
N67AAC Wood Base	\$							
N67BBC Plastic Base								
N67BBCJ Jury Base								
Dimensions								
Width	29	Arm Height	28-34	Seat Width	21¼	Weight	68	
Depth	28	Seat Height	17½-23¼	Back Height	27½	Cubic Ft.	20.4	
Height	45-50¾	Seat Depth	19					

Contemporary Mid Back



Model No.	Grade / List Price							
	1	2/COM	3/COL	4	6	7	L7	L8
N67CCC Wood Base	\$							
N67DDC Plastic Base								
N67DDCJ Jury Base								
Dimensions								
Width	29	Arm Height	28-34	Seat Width	20¼	Weight	60	
Depth	28	Seat Height	17½-23¼	Back Height	23¾	Cubic Ft.	19.1	
Height	41¼-47	Seat Depth	19					

Contemporary Guest

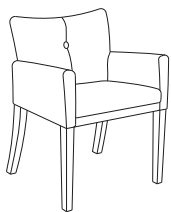

Model No.	Grade / List Price							
	1	2/COM	3/COL	4	6	7	L7	L8
N67EE	\$							
Dimensions								
Width	26½	Arm Height	25½	Seat Width	19½	Weight	39	
Depth	27½	Seat Height	18¼					
Height	37¼	Seat Depth	19½					

**Transitional
High Back**

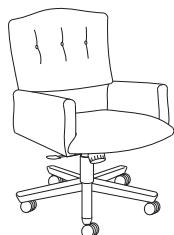

Model No.		Grade / List Price							
		1	2/COM	3/COL	4	6	7	L7	L8
N68AAC	Wood Base	\$							
N68BBC	Plastic Base								
N68BBCJ	Jury Base								
Dimensions									
Width	29	Arm Height	28-34	Seat Width	21¼	Weight	68		
Depth	28	Seat Height	17½-23¼	Back Height	27½	Cubic Ft.	20.4		
Height	45-50¾	Seat Depth	19						

**Transitional
Mid Back**



Model No.		Grade / List Price							
		1	2/COM	3/COL	4	6	7	L7	L8
N68CCC	Wood Base	\$							
N68DDC	Plastic Base								
N68DDCJ	Jury Base								
Dimensions									
Width	29	Arm Height	28-34	Seat Width	20¼	Weight	60		
Depth	28	Seat Height	17½-23¼	Back Height	23¾	Cubic Ft.	19.1		
Height	41¼-47	Seat Depth	19						

**Transitional
Guest**

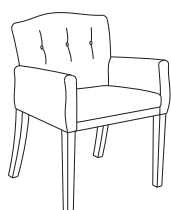

Model No.		Grade / List Price							
		1	2/COM	3/COL	4	6	7	L7	L8
N68EE		\$							
Dimensions									
Width	25¾	Arm Height	25¼	Seat Width	19½	Weight	38		
Depth	27½	Seat Height	18¾					Cubic Ft.	17.4
Height	36½	Seat Depth	19¾						

Medalist

To You In 10 DAYS ...or Less
 Shaded model numbers are available on our "To You in 10 Days or Less" Quick Delivery program and will be delivered within 10 days.

To Order, Specify:

1. Model Number
2. Fabric Grade Number
3. Cover Number
4. Finish Designator
5. Casters

• See page 263 for Medalist options

Medalist

Traditional High Back



Model No.	Grade / List Price								
		1	2/COM	3/COL	4	6	7	L7	L8
N69AAC	Wood Base	\$							
N69BBC	Plastic Base								
N69BBCJ	Jury Base								
Dimensions									
Width	29	Arm Height	26-31	Seat Width	21	Weight	68		
Depth	29½	Seat Height	17-22			Cubic Ft.	20.4		
Height	44½-49½	Seat Depth	19½						

Traditional Mid Back



Quick Delivery Model: QN69CCC									
Model No.	Grade / List Price								
		1	2/COM	3/COL	4	6	7	L7	L8
N69CCC	Wood Base	\$							
N69DDC	Plastic Base								
N69DDCJ	Jury Base								
Dimensions									
Width	29	Arm Height	26-31	Seat Width	20	Weight	60		
Depth	29½	Seat Height	17-22			Cubic Ft.	19.1		
Height	40¾-45½	Seat Depth	19						

Traditional Guest

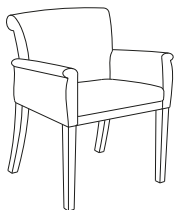

Quick Delivery Model: QN69EE									
Model No.	Grade / List Price								
		1	2/COM	3/COL	4	6	7	L7	L8
N69EE		\$							
Dimensions									
Width	26	Arm Height	25¾	Seat Width	19½	Weight	39		
Depth	27½	Seat Height	18¾			Cubic Ft.	17.4		
Height	36½	Seat Depth	19¾						

Mix-it®

MIX-IT MESH BACK PRODUCT SPECIFICATIONS N15/N16/N17 SERIES

SEAT CONSTRUCTION

- Recycled plastic inner seat shell designed with a deep ribbing pattern to ensure rigidity
- Seats feature 2½" of custom molded controlled density polyurethane foam for consistency and good contoured support on all models

BACK CONSTRUCTION

- Injection molded inner and outer shell
- Back features ¼" of high grade polyurethane foam on outside edge for support and comfort

MESH

- 100% Polyester
- Cleaning code: W
- 100,000+ double rubs

LUMBAR

- Lumbar can be adjusted approximately 2" by simply lifting and lowering the lumbar pad
- Lumbar pad features 1½" of high grade polyurethane foam for support and comfort

ADJUSTABLE ARMS

- Attached to the seat with metal brackets and screws; encased uprights are made of reinforced nylon
- Adjusts 8 positions in height within a 4" range
- Adjusts 5 positions in width and a 4" range for optimum comfort

STATIC ARMS

- Static arms have twin ⅞" x 16-gauge tubular steel uprights
- Seat and arm mounting components are made of ⅞" x 1" steel plates

HIGH PERFORMANCE ARMS

- Adjusts 10 positions in height within a 4" range
- Width adjustment allows arms to adjust within a 3" range
- Arm pad features depth, width and pivot adjustment
- Encased uprights are made of reinforced nylon

ARM PADS

- N15 Series models feature a soft polyurethane cap
- N16 and N17 Series models feature a soft polyurethane cap protecting a hard maple laminated wood detail; the N16 Series guest chairs also feature kiln dried exterior hard maple arms

CONTROL MECHANISM—SYNCHRONOUS TILT

- Synchronous tilt control allows the back and seat to move in a synchronized 2.3:1 ratio motion
- Free float feature allows the chair to tilt freely
- A side activated telescoping tension adjustment handle provides a comfortable way to adjust back tension to meet individual needs
- The back angle can be locked in one of five positions
- Standard pneumatic gas cylinder lift allows seat to raise and lower 4¼" and provides spring action for added comfort
- Seat slide option adjusts seat depth within a 2½" range

CONTROL MECHANISM—KNEE TILT

- Standard knee tilt mechanism features heavy-duty adjustable tension spring for a variety of body sizes and minimal rise of front seat edge; this allows the user's feet to remain planted when chair is in a reclining position
- The combination gas lift/tilt lock lever allows dual function with simple in/out movement for lockout and up/down movement for height adjustment

LIFT

- Pneumatic gas cylinder lift allows seat to raise and lower 5" and provides spring action for added comfort; finger grip lever adjustment is quick and easy

BASE AND CASTERS

- N15 and N16 Series models feature a five-prong black glass filled nylon for beauty and a long life
- N17 Series models feature a wood base with a standard five prong, rigid steel understructure to ensure a long life; decorative hardwood caps complement the chair design
- All bases have black, hard double wheel casters, which work on multiple surfaces
- Black, soft double wheel casters are available for use on hard floors; upcharge applies to this option
- Platinum Metallic option models feature a cast aluminum base

GLIDES

- Black nylon ball glides are standard

FINISH AND PAINT

- Wood finish features a catalyzed top coat which resists denting, peeling; can be cleaned with a damp cloth
- Metal paint features an electrostatically baked on black textured powder coat or smooth Platinum Metallic; can be cleaned with a damp cloth

WOOD SPECIES (N16, N17 SERIES)

- Hard maple

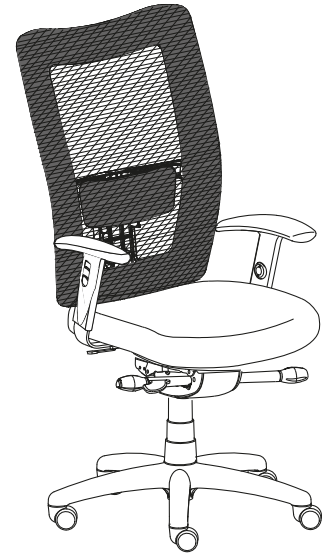

All Mix-it models may be ordered to meet TB133 fire code.

To order seating to meet the TB133 fire code, specify an "F" at the end of the model number (Ex: N15EEF).

Reference pages 453-477 for TB133 Fabric Matrix and pricing.

Please consult customer service for applicable Arc-Com, COM, Maharam, Momentum, Stinson or Ultrafabrics fabric.

FABRICS

Grade 1	American Graffiti
	Cali
	Plush
	Ridge
	Stardust
Grade 2	COM
	Orbit
	Pixie
	Sedona
	Shenanigans
	Spectrum
	Strand
	Twilight

Grade 3	Boardwalk
	COL
	Jacks
	Pop Rocks

Grade 4	Bumble
	Connect Four
	Echo
	Silvertex

Grade 5	Mode
---------	------

Grade 6	Essence/Ultraleather
	Flock
	Scribe

Grade 7	Brisa
	Brisa Distressed
	Promessa
	Silica

Grade L7	Davenport
----------	-----------

Grade L8	Showcase
----------	----------

FINISHES

AC	Autumn	MH	Mocha
AD	Almond	NM	Natural
CL	Caramel	PB	Portobello
CW	Cordovan	TF	Truffle
DW	Judicial	405	Designer White
HN	Honey	462	Cinder
IM	Brighton	792	Sable
MC	Amber	793	Acorn

CASTERS

FOR BLACK BASE

C15	Hard (standard)
C2	Soft (add \$25 list)

FOR PLATINUM BASE

C1	Hard (standard)
C2	Soft (add \$25 list)

FOR WOOD BASE

C3	Hard (standard)
C4	Soft (add \$25 list)

TO ORDER, SPECIFY:

1. Model Number
2. Fabric Grade Number
3. Cover Number
4. Finish Designator
5. Casters

• See page 269 for Mix-it options

**MESH BACK
ARMLESS
KNEE TILT
PLASTIC BASE**



MODEL NO.		GRADE / LIST PRICE								
		1	2/COM	3/COL	4	5	6	7	L7	L8
N15GR		\$ 619	640	650	664	680	709	746	923	980
N15GRS	Seatslide	714	735	745	759	775	804	841	1018	1075
N15LR	Lumbar	729	750	760	774	790	819	856	1033	1090
N15LRS	Lumbar/Seatslide	824	845	855	869	885	914	951	1128	1185

DIMENSIONS

Width	26¼	Seat Height	16-20	Back Height	23½	Weight	36
Depth	26	Seat Height with Seatslide	16½-20½	Back Width	17¾	Weight with Seatslide	39
Depth with Seatslide	25¼-26¾	Seat Depth	16¾			Cubic Ft.	19.1
Height	39½-43½	Seat Depth with Seatslide	16¾-19¼				
Height with Seatslide	40-44	Seat Width	20¼				

• Platinum Metallic option – specify P (i.e., N15GRP) available for a \$133 list upcharge

**MESH BACK
STATIC ARM
KNEE TILT
PLASTIC BASE**



MODEL NO.		GRADE / LIST PRICE								
		1	2/COM	3/COL	4	5	6	7	L7	L8
N15ER		\$ 775	796	806	820	836	865	902	1079	1136
N15ERS	Seatslide	870	891	901	915	931	960	997	1174	1231
N15HR	Lumbar	886	907	917	931	947	976	1013	1190	1247
N15HRS	Lumbar/Seatslide	980	1001	1011	1025	1041	1070	1107	1284	1341

DIMENSIONS

Width	26¼	Seat Height	16-20	Arm Height	26½-30	Weight	45
Depth	26	Seat Height with Seatslide	16½-20½	Back Height	23½	Weight with Seatslide	48
Depth with Seatslide	25¼-26¾	Seat Depth	16¾	Back Width	17¾	Cubic Ft.	19.1
Height	39½-43½	Seat Depth with Seatslide	16¾-19¼				
Height with Seatslide	40-44	Seat Width	20¼				

• Platinum Metallic option – specify P (i.e., N15ERP) available for a \$133 list upcharge



Static Arm

**MESH BACK
HEIGHT ADJUSTABLE ARM
KNEE TILT
PLASTIC BASE**



Height Adjustable Arm

MODEL NO.

GRADE / LIST PRICE

		1	2/COM	3/COL	4	5	6	7	L7	L8
N15TR	Plastic Back	\$ 768	789	799	813	829	858	895	1072	1129
N15TRS	Plastic Back/Seatslide	865	886	896	910	926	955	992	1169	1226
N15PT	Upholstered Back	878	899	909	923	939	968	1005	1182	1239
N15PTS	Upholstered Back/Seatslide	975	996	1006	1020	1036	1065	1102	1279	1336

DIMENSIONS

Width	26¼	Seat Height	16-20	Arm Height	24¼-32¼	Weight	47
Depth	26	Seat Height with		Back Height	23½	Weight with	
Depth with		Seatslide	16½-20½	Back Width	17¼	Seatslide	50
Seatslide	25¼-26¾	Seat Depth	16¾			Cubic Ft.	19.1
Height	39½-43½	Seat Depth with					
Height with		Seatslide	16¾-19¼				
Seatslide	40-44	Seat Width	20				

• Platinum Metallic option – specify P (i.e., N15TRP) available for a \$133 list upcharge

**MESH BACK
HEIGHT, WIDTH
ADJUSTABLE ARM
KNEE TILT
PLASTIC BASE**



Height, Width Adjustable Arm

		1	2/COM	3/COL	4	5	6	7	L7	L8
N15MR		\$ 793	814	824	838	854	883	920	1097	1154
N15MRS	Seatslide	890	911	921	935	951	980	1017	1194	1251
N15PR	Lumbar	903	924	934	948	964	993	1030	1207	1264
N15PRS	Lumbar/Seatslide	1000	1021	1031	1045	1061	1090	1127	1304	1361

DIMENSIONS

Width	26¼-29¼	Seat Height	16-20	Arm Height	24¼-32¼	Weight	47
Depth	26	Seat Height with		Back Height	23½	Weight with	
Depth with		Seatslide	16½-20½	Back Width	17¼	Seatslide	50
Seatslide	25¼-26¾	Seat Depth	16¾			Cubic Ft.	19.1
Height	39½-43½	Seat Depth with					
Height with		Seatslide	16¾-19¼				
Seatslide	40-44	Seat Width	20¼				

• Platinum Metallic option – specify P (i.e., N15MRP) available for a \$133 list upcharge

**MESH BACK
HIGH PERFORMANCE ARM
KNEE TILT
PLASTIC BASE**



High Performance Arm

		1	2/COM	3/COL	4	5	6	7	L7	L8
N15MRE		\$ 903	924	934	948	964	993	1030	1207	1264
N15MRES	Seatslide	1000	1021	1031	1045	1061	1090	1127	1304	1361
N15PRE	Lumbar	1013	1034	1044	1058	1074	1103	1140	1317	1374
N15PRES	Lumbar/Seatslide	1110	1131	1141	1155	1171	1200	1237	1414	1471

DIMENSIONS

Width	26¼-29¼	Seat Height	16-20	Arm Height	24¼-32¼	Weight	47
Depth	26	Seat Height with		Back Height	23½	Weight with	
Depth with		Seatslide	16½-20	Back Width	17¼	Seatslide	50
Seatslide	25¼-26¾	Seat Depth	16¾			Cubic Ft.	19.1
Height	39½-43½	Seat Depth with					
Height with		Seatslide	16¾-19¼				
Seatslide	40-44	Seat Width	20¼				

• Platinum Metallic option – specify P (i.e., N15MREP) available for a \$133 list upcharge

TO ORDER, SPECIFY:

1. Model Number
2. Fabric Grade Number
3. Cover Number
4. Finish Designator
5. Casters

• See page 269 for Mix-it options

**MESH BACK
STATIC WOOD ARM
KNEE TILT
PLASTIC BASE**



Static Wood Arm

MODEL NO.		GRADE / LIST PRICE									
		1	2/COM	3/COL	4	5	6	7	L7	L8	
N16ER		\$ 869	890	900	914	930	959	996	1173	1230	
N16ERS	Seatslide	964	985	995	1009	1025	1054	1091	1268	1325	
N16HR	Lumbar	979	1000	1010	1024	1040	1069	1106	1283	1340	
N16HRS	Lumbar/Seatslide	1074	1095	1105	1119	1135	1164	1201	1378	1435	

DIMENSIONS

Width	26¼	Seat Height	16-20	Arm Height	26½-30	Weight	48
Depth	26	Seat Height with Seatslide	16½-20½	Back Height	23½	Weight with Seatslide	51
Depth with Seatslide	25¼-26¾	Seat Depth	16¾	Back Width	17¾	Cubic Ft.	19.1
Height	39½-43½	Seat Depth with Seatslide	16¾-19¼				
Height with Seatslide	40-44	Seat Width	20¼				

• Platinum Metallic option – specify P (i.e., N16ERP) available for a \$133 list upcharge

**MESH BACK
HEIGHT ADJUSTABLE
WOOD ARM
KNEE TILT
PLASTIC BASE**



Height Adjustable Wood Arm

MODEL NO.		GRADE / LIST PRICE									
		1	2/COM	3/COL	4	5	6	7	L7	L8	
N16TR		\$ 865	886	896	910	926	955	992	1169	1226	
N16TRS	Seatslide	957	978	988	1002	1018	1047	1084	1261	1318	
N16PT	Lumbar	975	996	1006	1020	1036	1065	1102	1279	1336	
N16PTS	Lumbar /Seatslide	1069	1090	1100	1114	1130	1159	1196	1373	1430	

DIMENSIONS

Width	26¼	Seat Height	16-20	Arm Height	24¼-32¼	Weight	48
Depth	26	Seat Height with Seatslide	16½-20½	Back Height	23½	Weight with Seatslide	51
Depth with Seatslide	25¼-26¾	Seat Depth	16¾	Back Width	17¾	Cubic Ft.	19.1
Height	39½-43½	Seat Depth with Seatslide	16¾-19¼				
Height with Seatslide	40-44	Seat Width	20¼				

• Platinum Metallic option not available

**MESH BACK
HEIGHT, WIDTH
ADJUSTABLE WOOD ARM
KNEE TILT
PLASTIC BASE**



Height, Width Adjustable
Wood Arm

MODEL NO.		GRADE / LIST PRICE									
		1	2/COM	3/COL	4	5	6	7	L7	L8	
N16MR		\$ 890	911	921	935	951	980	1017	1194	1251	
N16MRS	Seatslide	983	1004	1014	1028	1044	1073	1110	1287	1344	
N16PR	Lumbar	1000	1021	1031	1045	1061	1090	1127	1304	1361	
N16PRS	Lumbar/Seatslide	1094	1115	1125	1139	1155	1184	1221	1398	1455	

DIMENSIONS

Width	26¼-29¼	Seat Height	16-20	Arm Height	24¼-32¼	Weight	50
Depth	26	Seat Height with		Back Height	23½	Weight with	
Depth with		Seatslide	16½-20½	Back Width	17¾	Seatslide	53
Seatslide	25¼-26½	Seat Depth	16¾			Cubic Ft.	19.1
Height	39½-43½	Seat Depth with					
Height with		Seatslide	16¾-19¼				
Seatslide	40-44	Seat Width	20¼				

- Platinum Metallic option not available

**MESH BACK
ARMLESS
SYNCHRONOUS
PLASTIC BASE**

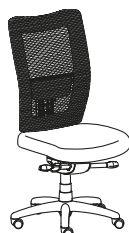

MODEL NO.		GRADE / LIST PRICE									
		1	2/COM	3/COL	4	5	6	7	L7	L8	
N15GG		\$ 702	723	733	747	763	792	829	1006	1063	
N15GGS	Seatslide	797	818	828	842	858	887	924	1101	1158	
N15LL	Lumbar	812	833	843	857	873	902	939	1116	1173	
N15LLS	Lumbar/Seatslide	907	928	938	952	968	997	1034	1211	1268	

DIMENSIONS

Width	26¼	Seat Height	17¼-22¼	Back Height	23½	Weight	41
Depth	26	Seat Height with		Back Width	17¾	Weight with	
Depth with		Seatslide	17¾-22¾			Seatslide	44
Seatslide	25¼-26½	Seat Depth	16¾			Cubic Ft.	19.1
Height	40¼-45¾	Seat Depth with					
Height with		Seatslide	16½-18¾				
Seatslide	41¼-46¼	Seat Width	20¼				

- Platinum Metallic option – specify P (i.e., N15GGP) available for a \$133 list upcharge

**MESH BACK
STATIC ARM
SYNCHRONOUS
PLASTIC BASE**



Static Arm

MODEL NO.		GRADE / LIST PRICE									
		1	2/COM	3/COL	4	5	6	7	L7	L8	
N15EE		\$ 857	878	888	902	918	947	984	1161	1218	
N15EES	Seatslide	952	973	983	997	1013	1042	1079	1256	1313	
N15HH	Lumbar	968	989	999	1013	1029	1058	1095	1272	1329	
N15HHS	Lumbar/Seatslide	1064	1085	1095	1109	1125	1154	1191	1368	1425	

DIMENSIONS

Width	26¼	Seat Height	17¼-22¼	Arm Height	27¼-32¼	Weight	47
Depth	26	Seat Height with		Back Height	23½	Weight with	
Depth with		Seatslide	17¾-22¾	Back Width	17¾	Seatslide	50
Seatslide	25¼-26½	Seat Depth	16¾			Cubic Ft.	19.1
Height	40¼-45¾	Seat Depth with					
Height with		Seatslide	16½-18¾				
Seatslide	41¼-46¼	Seat Width	20¼				

- Platinum Metallic option – specify P (i.e., N15EEP) available for a \$133 list upcharge

Mix-it

To You In 10 DAYS ...or Less
 Shaded model numbers are available on our "To You in 10 Days or Less" Quick Delivery program and will be delivered within 10 days.

TO ORDER, SPECIFY:

1. Model Number
 2. Fabric Grade Number
 3. Cover Number
 4. Finish Designator
 5. Casters
- See page 269 for Mix-it options

MESH BACK HEIGHT ADJUSTABLE ARM SYNCHRONOUS PLASTIC BASE



Height Adjustable Arm

MODEL NO.

GRADE / LIST PRICE

Quick Delivery Model: QN15TMS

		1	2/COM	3/COL	4	5	6	7	L7	L8
N15TM		\$ 832	853	863	877	893	922	959	1136	1193
N15TMS	Seatslide	927	948	958	972	988	1017	1054	1231	1288
N15TP	Lumbar	961	982	992	1006	1022	1051	1088	1265	1322
N15TPS	Lumbar/Seatslide	1056	1077	1087	1101	1117	1146	1183	1360	1417

DIMENSIONS

Width	26¼	Seat Height	17¼-22¼	Arm Height	25½-34½	Weight	49
Depth	26	Seat Height with		Back Height	23¼	Weight with	
Depth with		Seatslide	17¾-22¾	Back Width	17¾	Seatslide	52
Seatslide	25¼-26½	Seat Depth	17			Cubic Ft.	19.1
Height	40¾-45¾	Seat Depth with					
Height with		Seatslide	16½-18				
Seatslide	41¼-46¼	Seat Width	20¼				

- Platinum Metallic option – specify P (i.e., N15TMP) available for a \$133 list upcharge

MESH BACK HEIGHT, WIDTH ADJUSTABLE ARM SYNCHRONOUS PLASTIC BASE



Height, Width Adjustable Arm

Quick Delivery Model: QN15MMS

		1	2/COM	3/COL	4	5	6	7	L7	L8
N15MM		\$ 876	897	907	921	937	966	1003	1180	1237
N15MMS	Seatslide	972	993	1003	1017	1033	1062	1099	1276	1333
N15PP	Lumbar	986	1007	1017	1031	1047	1076	1113	1290	1347
N15PPS	Lumbar/Seatslide	1082	1103	1113	1127	1143	1172	1209	1386	1443

DIMENSIONS

Width	26¼-29¼	Seat Height	17½-22½	Arm Height	25½-34½	Weight	49
Depth	26	Seat Height with		Back Height	23¼	Weight with	
Depth with		Seatslide	17¾-22¾	Back Width	17¾	Seatslide	52
Seatslide	25¼-26½	Seat Depth	17			Cubic Ft.	19.1
Height	40¾-45¾	Seat Depth with					
Height with		Seatslide	16½-18¾				
Seatslide	41¼-46¼	Seat Width	20¼				

- Platinum Metallic option – specify P (i.e., N15MMP) available for a \$133 list upcharge

**MESH BACK
HIGH PERFORMANCE ARM
SYNCHRONOUS
PLASTIC BASE**



High Performance Arm

**MODEL
NO.**

GRADE / LIST PRICE

Quick Delivery Model: QN15MMES

		1	2/COM	3/COL	4	5	6	7	L7	L8
N15MME		\$ 986	1007	1017	1031	1047	1076	1113	1290	1347
N15MMES	Seatslide	1082	1103	1113	1127	1143	1172	1209	1386	1443
N15PPE	Lumbar	1097	1118	1128	1142	1158	1187	1224	1401	1458
N15PPES	Lumbar/Seatslide	1192	1213	1223	1237	1253	1282	1319	1496	1553

DIMENSIONS

Width	26¼-29¼	Seat Height	17¼-22¼	Arm Height	25½-34½	Weight	49
Depth	26	Seat Height with		Back Height	23¼	Weight with	
Depth with		Seatslide	17¾-22¾	Back Width	17¾	Seatslide	52
Seatslide	25¼-26½	Seat Depth	17			Cubic Ft.	19.1
Height	40¾-45¾	Seat Depth with					
Height with		Seatslide	16½-18¾				
Seatslide	41¼-46¼	Seat Width	20¼				

• Platinum Metallic option – specify P (i.e., N15MMEP) available for a \$133 list upcharge

**MESH BACK
STATIC WOOD ARM
SYNCHRONOUS
PLASTIC BASE**



Static Wood Arm

		1	2/COM	3/COL	4	5	6	7	L7	L8
N16EE		\$ 951	972	982	996	1012	1041	1078	1255	1312
N16EES	Seatslide	1045	1066	1076	1090	1106	1135	1172	1349	1406
N16HH	Lumbar	1063	1084	1094	1108	1124	1153	1190	1367	1424
N16HHS	Lumbar/Seatslide	1155	1176	1186	1200	1216	1245	1282	1459	1516

DIMENSIONS

Width	26¼	Seat Height	17¼-22¼	Arm Height	25½-34½	Weight	48
Depth	26	Seat Height with		Back Height	23¼	Weight with	
Depth with		Seatslide	17¾-22¾	Back Width	17¾	Seatslide	51
Seatslide	25¼-26½	Seat Depth	17			Cubic Ft.	19.1
Height	40¾-45¾	Seat Depth with					
Height with		Seatslide	16½-18¾				
Seatslide	41¼-46¼	Seat Width	20¼				

• Platinum Metallic option – specify P (i.e., N16EEP) available for a \$133 list upcharge

**MESH BACK
HEIGHT ADJUSTABLE
WOOD ARM
SYNCHRONOUS
PLASTIC BASE**



Height Adjustable Wood Arm

		1	2/COM	3/COL	4	5	6	7	L7	L8
N16TM		\$ 946	967	977	991	1007	1036	1073	1250	1307
N16TMS	Seatslide	1040	1061	1071	1085	1101	1130	1167	1344	1401
N16TP	Lumbar	1056	1077	1087	1101	1117	1146	1183	1360	1417
N16TPS	Lumbar /Seatslide	1150	1171	1181	1195	1211	1240	1277	1454	1511

DIMENSIONS

Width		Seat Height	17¼-22¼	Arm Height	25½-34½	Weight	48
Depth		Seat Height with		Back Height	23¼	Weight with	
Depth with		Seatslide	17¾-22¾	Back Width		Seatslide	51
Seatslide		Seat Depth	17			Cubic Ft.	19.1
Height	40¾-45¾	Seat Depth with					
Height with		Seatslide					
Seatslide	41¼-46¼	Seat Width					

• Platinum Metallic option not available

To You In 10 DAYS ...or Less
 Shaded model numbers are available on our "To You in 10 Days or Less" Quick Delivery program and will be delivered within 10 days.

TO ORDER, SPECIFY:

1. Model Number
 2. Fabric Grade Number
 3. Cover Number
 4. Finish Designator
 5. Casters
- See page 269 for Mix-it options

**MESH BACK
 HEIGHT, WIDTH
 ADJUSTABLE WOOD ARM
 SYNCHRONOUS
 PLASTIC BASE**



Height, Width Adjustable
 Wood Arm

MODEL NO.	GRADE / LIST PRICE									
	1	2/COM	3/COL	4	5	6	7	L7	L8	
N16MM	\$ 972	993	1003	1017	1033	1062	1099	1276	1333	
N16MMS Seatslide	1066	1087	1097	1111	1127	1156	1193	1370	1427	
N16PP Lumbar	1082	1103	1113	1127	1143	1172	1209	1386	1443	
N16PPS Lumbar/Seatslide	1176	1197	1207	1221	1237	1266	1303	1480	1537	

DIMENSIONS

Width	26¼-29¼	Seat Height	17¼-22¼	Arm Height	25½-34½	Weight	50
Depth	26	Seat Height with Seatslide	17¾-22¾	Back Height	23¼	Weight with Seatslide	53
Depth with Seatslide	25¼-26½	Seat Depth	17	Back Width	17¾	Cubic Ft.	19.1
Height	40¾-45¾	Seat Depth with Seatslide	16½-18¾				
Height with Seatslide	41¼-46¼	Seat Width	20¼				

• Platinum Metallic option not available

**MESH BACK
 GUEST
 POLYURETHANE ARMS**

Quick Delivery Model: QN15RR

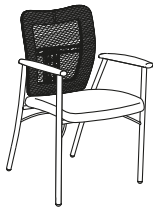

MODEL NO.	GRADE / LIST PRICE									
	1	2/COM	3/COL	4	5	6	7	L7	L8	
N15RR	\$ 628	649	659	673	689	718	755	932	989	

DIMENSIONS

Width	24¾	Seat Height	18½	Arm Height	26¼	Weight	29
Depth	24	Seat Depth	18¾	Kneespace	20	Cubic Ft.	16.4
Height	36¼	Seat Width	20¾				

• Platinum Metallic option – specify P (i.e., N15RRP) available for a \$35 list upcharge

**MESH BACK
ARMLESS
KNEE TILT
WOOD BASE**



**MODEL
NO.**

GRADE / LIST PRICE

		1	2/COM	3/COL	4	5	6	7	L7	L8
N17GR		\$ 700	721	731	745	761	790	827	1004	1061
N17GRS	Seatslide	794	815	825	839	855	884	921	1098	1155
N17LR	Lumbar	810	831	841	855	871	900	937	1114	1171
N17LRS	Lumbar/Seatslide	904	925	935	949	965	994	1031	1208	1265

DIMENSIONS

Width	26¼	Seat Height	16¼-20¼	Back Height	23½	Weight	47
Depth	26¼	Seat Height with		Back Width	17¾	Weight with	
Depth with		Seatslide	16¼-20¼			Seatslide	50
Seatslide	25¼-26¾	Seat Depth	16¾			Cubic Ft.	19.1
Height	39¾-43¾	Seat Depth with					
Height with		Seatslide	16¼-19¼				
Seatslide	40¼-44¼	Seat Width	20¼				

• Platinum Metallic option not available

**MESH BACK
STATIC WOOD ARM
KNEE TILT
WOOD BASE**



Static Wood Arm

		1	2/COM	3/COL	4	5	6	7	L7	L8
N17ER		\$ 950	971	981	995	1011	1040	1077	1254	1311
N17ERS	Seatslide	1153	1174	1184	1198	1214	1243	1280	1457	1514
N17HR	Lumbar	1062	1083	1093	1107	1123	1152	1189	1366	1423
N17HRS	Lumbar/Seatslide	1264	1285	1295	1309	1325	1354	1391	1568	1625

DIMENSIONS

Width	26¼	Seat Height	16¼-20¼	Arm Height	26¾-30¼	Weight	54
Depth	26¼	Seat Height with		Back Height	23½	Weight with	
Depth with		Seatslide	16¼-20¼	Back Width	17¾	Seatslide	57
Seatslide	25¼-26¾	Seat Depth	16¾			Cubic Ft.	19.1
Height	39¾-43¾	Seat Depth with					
Height with		Seatslide	16¼-19¼				
Seatslide	40¼-44¼	Seat Width	20¼				

• Platinum Metallic option not available

**MESH BACK
HEIGHT ADJUSTABLE
WOOD ARM
KNEE TILT
WOOD BASE**



Height Adjustable Wood Arm

		1	2/COM	3/COL	4	5	6	7	L7	L8
N17TR		\$ 946	967	977	991	1007	1036	1073	1250	1307
N17TRS	Seatslide	1042	1063	1073	1087	1103	1132	1169	1346	1403
N17PT	Lumbar	1056	1077	1087	1101	1117	1146	1183	1360	1417
N17PTS	Lumbar /Seatslide	1152	1173	1183	1197	1213	1242	1279	1456	1513

DIMENSIONS

Width	26¼	Seat Height	16¼-20¼	Arm Height	24-32	Weight	56
Depth	26¼	Seat Height with		Back Height	23½	Weight with	
Depth with		Seatslide	16¼-20¼	Back Width	17¾	Seatslide	58
Seatslide	25¼-26¾	Seat Depth	16¾			Cubic Ft.	19.1
Height	39¾-43¾	Seat Depth with					
Height with		Seatslide	16¼-19¼				
Seatslide	40¼-44¼	Seat Width	20¼				

• Platinum Metallic option not available

TO ORDER, SPECIFY:

1. Model Number
 2. Fabric Grade Number
 3. Cover Number
 4. Finish Designator
 5. Casters
- See page 269 for Mix-it options

**MESH BACK
HEIGHT, WIDTH
ADJUSTABLE WOOD ARM
KNEE TILT
WOOD BASE**



Height, Width Adjustable
Wood Arm

MODEL NO.		GRADE / LIST PRICE									
		1	2/COM	3/COL	4	5	6	7	L7	L8	
N17MR		\$ 972	993	1003	1017	1033	1062	1099	1276	1333	
N17MRS	Seatslide	1068	1089	1099	1113	1129	1158	1195	1372	1429	
N17PR	Lumbar	1082	1103	1113	1127	1143	1172	1209	1386	1443	
N17PRS	Lumbar/Seatslide	1178	1199	1209	1223	1239	1268	1305	1482	1539	

DIMENSIONS

Width	26¼-29¼	Seat Height	16¼-20¼	Arm Height	24-32	Weight	56
Depth	26¾	Seat Height with Seatslide	16¾-20¾	Back Height	23½	Weight with Seatslide	59
Depth with Seatslide	25¼-26¾	Seat Depth	17	Back Width	17¾	Cubic Ft.	19.1
Height	39¾-43¾	Seat Depth with Seatslide	16¾-19¼				
Height with Seatslide	40¼-44¼	Seat Width	20¼				

• Platinum Metallic option not available

**MESH BACK
ARMLESS
SYNCHRONOUS
WOOD BASE**



MODEL NO.		GRADE / LIST PRICE									
		1	2/COM	3/COL	4	5	6	7	L7	L8	
N17GG		\$ 783	804	814	828	844	873	910	1087	1144	
N17GGS	Seatslide	877	898	908	922	938	967	1004	1181	1238	
N17LL	Lumbar	893	914	924	938	954	983	1020	1197	1254	
N17LLS	Lumbar/Seatslide	987	1008	1018	1032	1048	1077	1114	1291	1348	

DIMENSIONS

Width	26¼	Seat Height	17¼-22½	Back Height	23½	Weight	51
Depth	26¾	Seat Height with Seatslide	18-23	Back Width	17¾	Weight with Seatslide	44
Depth with Seatslide	25¼-26½	Seat Depth	17			Cubic Ft.	19.1
Height	41-46	Seat Depth with Seatslide	16½-18¾				
Height with Seatslide	41½-46½	Seat Width	20¼				

• Platinum Metallic option not available

**MESH BACK
STATIC WOOD ARM
SYNCHRONOUS
WOOD BASE**



Static Wood Arm

**MODEL
NO.**

GRADE / LIST PRICE

		1	2/COM	3/COL	4	5	6	7	L7	L8
N17EE		\$ 1033	1054	1064	1078	1094	1123	1160	1337	1394
N17EES	Seatslide	1238	1259	1269	1283	1299	1328	1365	1542	1599
N17HH	Lumbar	1143	1164	1174	1188	1204	1233	1270	1447	1504
N17HHS	Lumbar/Seatslide	1348	1369	1379	1393	1409	1438	1475	1652	1709

DIMENSIONS

Width	26¼	Seat Height	17½-22½	Arm Height	26½-34½	Weight	48
Depth	26¼	Seat Height with		Back Height	23½	Weight with	
Depth with		Seatslide	18-23	Back Width	17¾	Seatslide	51
Seatslide	25¼-26½	Seat Depth	17			Cubic Ft.	19.1
Height	41-46	Seat Depth with					
Height with		Seatslide	16½-18¾				
Seatslide	41½-46½	Seat Width	20¼				

• Platinum Metallic option not available

**MESH BACK
HEIGHT ADJUSTABLE
WOOD ARM
SYNCHRONOUS
WOOD BASE**



Height Adjustable Wood Arm

		1	2/COM	3/COL	4	5	6	7	L7	L8
N17TM		\$ 1030	1051	1061	1075	1091	1120	1157	1334	1391
N17TMS	Seatslide	1124	1145	1155	1169	1185	1214	1251	1428	1485
N17TP	Lumbar	1141	1162	1172	1186	1202	1231	1268	1445	1502
N17TPS	Lumbar /Seatslide	1234	1255	1265	1279	1295	1324	1361	1538	1595

DIMENSIONS

Width	26¼	Seat Height	17½-22½	Arm Height	25¼-34¼	Weight	54
Depth	26¼	Seat Height with		Back Height	23½	Weight with	
Depth with		Seatslide	18-23	Back Width	17¾	Seatslide	57
Seatslide	25¼-26½	Seat Depth	17			Cubic Ft.	19.1
Height	41-46	Seat Depth with					
Height with		Seatslide	16½-18¾				
Seatslide	41½-46½	Seat Width	20¼				

• Platinum Metallic option not available

**MESH BACK
HEIGHT, WIDTH
ADJUSTABLE WOOD ARM
SYNCHRONOUS
WOOD BASE**



Height, Width Adjustable
Wood Arm

		1	2/COM	3/COL	4	5	6	7	L7	L8
N17MM		\$ 1055	1076	1086	1100	1116	1145	1182	1359	1416
N17MMS	Seatslide	1149	1170	1180	1194	1210	1239	1276	1453	1510
N17PP	Lumbar	1167	1188	1198	1212	1228	1257	1294	1471	1528
N17PPS	Lumbar/Seatslide	1259	1280	1290	1304	1320	1349	1386	1563	1620

DIMENSIONS

Width	26¼-29¼	Seat Height	17½-22½	Arm Height	25¼-34¼	Weight	54
Depth	26¼	Seat Height with		Back Height	23½	Weight with	
Depth with		Seatslide	18-23	Back Width	17¾	Seatslide	57
Seatslide	25¼-26½	Seat Depth	17			Cubic Ft.	19.1
Height	41-46	Seat Depth with					
Height with		Seatslide	16½-18¾				
Seatslide	41½-46½	Seat Width	20¼				

• Platinum Metallic option not available

To You In 10 DAYS ...or Less
 Shaded model numbers are available on our "To You in 10 Days or Less" Quick Delivery program and will be delivered within 10 days.

TO ORDER, SPECIFY:

1. Model Number
 2. Fabric Grade Number
 3. Cover Number
 4. Finish Designator
 5. Casters
- See page 269 for Mix-it options

MESH BACK GUEST WOOD ARMS



MODEL NO.

GRADE / LIST PRICE

Quick Delivery Model: QN17RR

	1	2/COM	3/COL	4	5	6	7	L7	L8
N17RR	\$ 699	720	730	744	760	789	826	1003	1060

DIMENSIONS

Width	24¾	Seat Height	18½	Arm Height	26¾	Weight	29
Depth	24	Seat Depth	18¾	Kneespace	20	Cubic Ft.	16.4
Height	36¾	Seat Width	20¾				

- Platinum Metallic option – specify P (i.e., N17RRP) available for a \$35 list upcharge

MESH BACK STOOL ARMLESS KNEE TILT PLASTIC BASE



	1	2/COM	3/COL	4	5	6	7	L7	L8
N15ARY	\$ 712	733	743	757	773	802	839	1016	1073

DIMENSIONS

Width	26¾	Seat Height	22½-28¾	Back Height	19¾	Weight	42
Depth	26	Seat Depth	16¾	Back Width	17	Cubic Ft.	20.4
Height	41-50	Seat Width	20¾				

- Platinum Metallic option – specify P (i.e., N15ARYP) available for a \$133 list upcharge

MESH BACK STOOL STATIC ARM KNEE TILT PLASTIC BASE



	1	2/COM	3/COL	4	5	6	7	L7	L8
N15CRY	\$ 868	889	899	913	929	958	995	1172	1229

DIMENSIONS

Width	26¾	Seat Height	22½-28¾	Arm Height	32¾-39	Weight	48
Depth	26	Seat Depth	16¾	Back Height	19¾	Cubic Ft.	21.4
Height	41-50	Seat Width	20¾	Back Width	17		

- Platinum Metallic option – specify P (i.e., N15CRYP) available for a \$133 list upcharge



Static Arm

**MESH BACK STOOL
HEIGHT ADJUSTABLE ARM
KNEE TILT
PLASTIC BASE**

MODEL NO.

GRADE / LIST PRICE

	1	2/COM	3/COL	4	5	6	7	L7	L8
N15TRY	\$ 863	884	894	908	924	953	990	1167	1224

DIMENSIONS

Width	26¼-29¼	Seat Height	22½-28¾	Arm Height	31½-41	Weight	48
Depth	26	Seat Depth	16¾	Back Height	19¼	Cubic Ft.	20.4
Height	41-50	Seat Width	20¼	Back Width	17		

• Platinum Metallic option – specify P (i.e., N15TRYP) available for a \$133 list upcharge



Height Adjustable Arm

**MESH BACK STOOL
HEIGHT, WIDTH
ADJUSTABLE ARM
KNEE TILT
PLASTIC BASE**

	1	2/COM	3/COL	4	5	6	7	L7	L8
N15JRY	\$ 888	909	919	933	949	978	1015	1192	1249

DIMENSIONS

Width	26¼-29¼	Seat Height	22½-28¾	Arm Height	31½-41	Weight	48
Depth	26	Seat Depth	16¾	Back Height	19¼	Cubic Ft.	20.4
Height	41-50	Seat Width	20¼	Back Width	17		

• Platinum Metallic option – specify P (i.e., N15JRYEP) available for a \$133 list upcharge



Height, Width Adjustable Arm

**MESH BACK STOOL
HIGH PERFORMANCE ARM
KNEE TILT
PLASTIC BASE**

	1	2/COM	3/COL	4	5	6	7	L7	L8
N15JRYE	\$ 998	1019	1029	1043	1059	1088	1125	1302	1359

DIMENSIONS

Width	26¼-29¼	Seat Height	22½-28¾	Arm Height	31-41½	Weight	50
Depth	26	Seat Depth	16¾	Back Height	19¼	Cubic Ft.	20.4
Height	41-50	Seat Width	20¼	Back Width	17		

• Platinum Metallic option – specify P (i.e., N15JRYEP) available for a \$133 list upcharge



High Performance Arm

TO ORDER, SPECIFY:

1. Model Number
 2. Fabric Grade Number
 3. Cover Number
 4. Finish Designator
 5. Casters
- See page 269 for Mix-it options

**MESH BACK STOOL
STATIC WOOD ARM
KNEE TILT
PLASTIC BASE**



MODEL NO.	GRADE / LIST PRICE									
	1	2/COM	3/COL	4	5	6	7	L7	L8	
N16CRY	\$ 962	983	993	1007	1023	1052	1089	1266	1323	

DIMENSIONS

Width	26¼	Seat Height	22½-28¾	Arm Height	32¾-39	Weight	49
Depth	26	Seat Depth	16¾	Back Height	19¼	Cubic Ft.	20.4
Height	41-50	Seat Width	20¼	Back Width	17		

- Platinum Metallic option not available



Static Wood Arm

**MESH BACK STOOL
HEIGHT ADJUSTABLE
WOOD ARM
KNEE TILT
PLASTIC BASE**



MODEL NO.	GRADE / LIST PRICE									
	1	2/COM	3/COL	4	5	6	7	L7	L8	
N16TRY	\$ 958	979	989	1003	1019	1048	1085	1262	1319	

DIMENSIONS

Width	26¼-29¼	Seat Height	22½-28¾	Arm Height	31½-41	Weight	49
Depth	26	Seat Depth	16¾	Back Height	19¼	Cubic Ft.	20.4
Height	41-50	Seat Width	20¼	Back Width	17		

- Platinum Metallic option not available



Height Adjustable Wood Arm

**MESH BACK STOOL
HEIGHT, WIDTH
ADJUSTABLE WOOD ARM
KNEE TILT
PLASTIC BASE**



Height, Width Adjustable
Wood Arm

**MODEL
NO.**

GRADE / LIST PRICE

	1	2/COM	3/COL	4	5	6	7	L7	L8
N16JRY	\$ 984	1005	1015	1029	1045	1074	1111	1288	1345

DIMENSIONS

Width	26¼-29¼	Seat Height	22½-28¾	Arm Height	31½-41	Weight	49
Depth	26	Seat Depth	16¾	Back Height	19¼	Cubic Ft.	20.4
Height	41-50	Seat Width	20¼	Back Width	17		

• Platinum Metallic option not available

**MESH BACK STOOL
ARMLESS
SYNCHRONOUS
PLASTIC BASE**



	1	2/COM	3/COL	4	5	6	7	L7	L8
N15AAY	\$ 795	816	826	840	856	885	922	1099	1156

DIMENSIONS

Width	26¼	Seat Height	21¾-28¾	Back Height	19¼	Weight	47
Depth	26	Seat Depth	17	Back Width	17	Cubic Ft.	20.4
Height	39½-47½	Seat Width	20¼				

• Platinum Metallic option – specify P (i.e., N15AAYP) available for a \$133 list upcharge

**MESH BACK STOOL
STATIC ARM
SYNCHRONOUS
PLASTIC BASE**



Static Arm

	1	2/COM	3/COL	4	5	6	7	L7	L8
N15CCY	\$ 950	971	981	995	1011	1040	1077	1254	1311

DIMENSIONS

Width	26¼	Seat Height	21¾-28¾	Arm Height	32-39	Weight	53
Depth	26	Seat Depth	17	Back Height	19¼	Cubic Ft.	20.4
Height	39½-47½	Seat Width	20¼	Back Width	17		

• Platinum Metallic option – specify P (i.e., N15CCYP) available for a \$133 list upcharge

TO ORDER, SPECIFY:

1. Model Number
 2. Fabric Grade Number
 3. Cover Number
 4. Finish Designator
 5. Casters
- See page 269 for Mix-it options

**MESH BACK STOOL
HEIGHT ADJUSTABLE ARM
SYNCHRONOUS
PLASTIC BASE**



MODEL NO.	GRADE / LIST PRICE									
	1	2/COM	3/COL	4	5	6	7	L7	L8	
N15TJY	\$ 944	965	975	989	1005	1034	1071	1248	1305	

DIMENSIONS

Width	26¼-29¼	Seat Height	21¾-28¾	Arm Height	30¾-41	Weight	53
Depth	26	Seat Depth	17	Back Height	19¾	Cubic Ft.	20.4
Height	39½-47½	Seat Width	20¼	Back Width	17		

- Platinum Metallic option – specify P (i.e., N15TJYP) available for a \$133 list upcharge



Height Adjustable Arm

**MESH BACK STOOL
HEIGHT, WIDTH
ADJUSTABLE ARM
SYNCHRONOUS
PLASTIC BASE**



MODEL NO.	GRADE / LIST PRICE									
	1	2/COM	3/COL	4	5	6	7	L7	L8	
N15JJY	\$ 970	991	1001	1015	1031	1060	1097	1274	1331	

DIMENSIONS

Width	26¼-29¼	Seat Height	21¾-28¾	Arm Height	30¾-41	Weight	53
Depth	26	Seat Depth	17	Back Height	19¾	Cubic Ft.	20.4
Height	39½-47½	Seat Width	20¼	Back Width	17		

- Platinum Metallic option – specify P (i.e., N15JJYP) available for a \$133 list upcharge



Height, Width Adjustable Arm

**MESH BACK STOOL
HIGH PERFORMANCE ARM
SYNCHRONOUS
PLASTIC BASE**



High Performance Arm

MODEL NO.

GRADE / LIST PRICE

	1	2/COM	3/COL	4	5	6	7	L7	L8
N15JJYE	\$ 1080	1101	1111	1125	1141	1170	1207	1384	1441

DIMENSIONS

Width	26¼-29¼	Seat Height	21¾-28¾	Arm Height	30¼-41	Weight	55
Depth	26	Seat Depth	17	Back Height	19¼	Cubic Ft.	20.4
Height	39½-47½	Seat Width	20¼	Back Width	17		

- Platinum Metallic option – specify P (i.e., N15JJYEP) available for a \$133 list upcharge

**MESH BACK STOOL
STATIC WOOD ARM
SYNCHRONOUS
PLASTIC BASE**



Static Wood Arm

	1	2/COM	3/COL	4	5	6	7	L7	L8
N16CCY	\$ 1043	1064	1074	1088	1104	1133	1170	1347	1404

DIMENSIONS

Width	26¼	Seat Height	21¾-28¾	Arm Height	32-39	Weight	56
Depth	26	Seat Depth	17	Back Height	19¼	Cubic Ft.	20.4
Height	39½-47½	Seat Width	20¼	Back Width	17		

- Platinum Metallic option – specify P (i.e., N16CCYP) available for a \$133 list upcharge

**MESH BACK STOOL
HEIGHT ADJUSTABLE
WOOD ARM
SYNCHRONOUS
PLASTIC BASE**



Height Adjustable Wood Arm

	1	2/COM	3/COL	4	5	6	7	L7	L8
N16TJY	\$ 1041	1062	1072	1086	1102	1131	1168	1345	1402

DIMENSIONS

Width	26¼	Seat Height	21¾-28¾	Arm Height	30¼-41	Weight	56
Depth	26	Seat Depth	17	Back Height	19¼	Cubic Ft.	20.4
Height	39½-47½	Seat Width	20¼	Back Width	17		

- Platinum Metallic option not available

TO ORDER, SPECIFY:

1. Model Number
2. Fabric Grade Number
3. Cover Number
4. Finish Designator
5. Casters

• See page 269 for Mix-it options

**MESH BACK STOOL
HEIGHT, WIDTH
ADJUSTABLE WOOD ARM
SYNCHRONOUS
PLASTIC BASE**



Height, Width Adjustable
Wood Arm

MODEL NO.	GRADE / LIST PRICE									
	1	2/COM	3/COL	4	5	6	7	L7	L8	
N16JJY	\$ 1067	1088	1098	1112	1128	1157	1194	1371	1428	

DIMENSIONS

Width	26¼-29¼	Seat Height	21¾-28¾	Arm Height	30¾-41	Weight	56
Depth	26	Seat Depth	17	Back Height	19¼	Cubic Ft.	20.4
Height	39½-47½	Seat Width	20¼	Back Width	17		

• Platinum Metallic option not available

**MESH BACK STOOL
ARMLESS
KNEE TILT
WOOD BASE**



MODEL NO.	GRADE / LIST PRICE									
	1	2/COM	3/COL	4	5	6	7	L7	L8	
N17ARY	\$ 792	813	823	837	853	882	919	1096	1153	

DIMENSIONS

Width	26¼	Seat Height	22¾-29	Back Height	19¼	Weight	52
Depth	26	Seat Depth	16¾	Back Width	17	Cubic Ft.	20.4
Height	41¼-50¼	Seat Width	20¼				

**MESH BACK STOOL
STATIC WOOD ARM
KNEE TILT
WOOD BASE**



Static Wood Arm

MODEL NO.

GRADE / LIST PRICE

	1	2/COM	3/COL	4	5	6	7	L7	L8
N17CRY	\$ 1041	1062	1072	1086	1102	1131	1168	1345	1402

DIMENSIONS

Width	26¼	Seat Height	22¾-29	Arm Height	33-39¼	Weight	58
Depth	26	Seat Depth	16¾	Back Height	19¼	Cubic Ft.	20.4
Height	41¼-50¼	Seat Width	20¼	Back Width	17		

**MESH BACK STOOL
HEIGHT ADJUSTABLE
WOOD ARM
KNEE TILT
WOOD BASE**



Height Adjustable Wood Arm

	1	2/COM	3/COL	4	5	6	7	L7	L8
N17TRY	\$ 1041	1062	1072	1086	1102	1131	1168	1345	1402

DIMENSIONS

Width	26¼	Seat Height	22¾-29	Arm Height	33-39¼	Weight	58
Depth	26	Seat Depth	16¾	Back Height	19¼	Cubic Ft.	20.4
Height	41¼-50¼	Seat Width	20¼	Back Width	17		

**MESH BACK STOOL
HEIGHT, WIDTH
ADJUSTABLE WOOD ARM
KNEE TILT
WOOD BASE**



Height, Width Adjustable Wood Arm

	1	2/COM	3/COL	4	5	6	7	L7	L8
N17JRY	\$ 1067	1088	1098	1112	1128	1157	1194	1371	1428

DIMENSIONS

Width	26¼-29¼	Seat Height	22¾-29	Arm Height	31¼-39¼	Weight	58
Depth	26	Seat Depth	16¾	Back Height	19¼	Cubic Ft.	20.4
Height	41¼-50¼	Seat Width	20¼	Back Width	17		

TO ORDER, SPECIFY:

1. Model Number
 2. Fabric Grade Number
 3. Cover Number
 4. Finish Designator
 5. Casters
- See page 269 for Mix-it options

**MESH BACK STOOL
ARMLESS
SYNCHRONOUS
WOOD BASE**



MODEL NO.	GRADE / LIST PRICE									
	1	2/COM	3/COL	4	5	6	7	L7	L8	
N17AAY	\$ 874	895	905	919	935	964	1001	1178	1235	
DIMENSIONS										
Width	26¼	Seat Height	22¼-29	Back Height	19¼	Weight	51			
Depth	26	Seat Depth	17	Back Width	17	Cubic Ft.	20.4			
Height	39¼-47¼	Seat Width	20¼							

**MESH BACK STOOL
STATIC WOOD ARM
SYNCHRONOUS
WOOD BASE**



MODEL NO.	GRADE / LIST PRICE									
	1	2/COM	3/COL	4	5	6	7	L7	L8	
N17CCY	\$ 1125	1146	1156	1170	1186	1215	1252	1429	1486	
DIMENSIONS										
Width	26¼	Seat Height	22¼-29	Arm Height	32¼-39¼	Weight	57			
Depth	26	Seat Depth	17	Back Height	19¼	Cubic Ft.	20.4			
Height	39¼-47¼	Seat Width	20¼	Back Width	17					



Static Wood Arm

**MESH BACK STOOL
HEIGHT ADJUSTABLE
WOOD ARM
SYNCHRONOUS
WOOD BASE**

**MODEL
NO.**

GRADE / LIST PRICE

	1	2/COM	3/COL	4	5	6	7	L7	L8
N17TJY	\$ 1123	1144	1154	1168	1184	1213	1250	1427	1484

DIMENSIONS

Width	26¼-29¼	Seat Height	22¼-29	Arm Height	31¼-41¼	Weight	57
Depth	26	Seat Depth	17	Back Height	19¼	Cubic Ft.	
Height	39¼-47¼	Seat Width	20¼	Back Width	17		



Height Adjustable Wood Arm

**MESH BACK STOOL
HEIGHT, WIDTH
ADJUSTABLE WOOD ARM
SYNCHRONOUS
WOOD BASE**

	1	2/COM	3/COL	4	5	6	7	L7	L8
N17JJY	\$ 1148	1169	1179	1193	1209	1238	1275	1452	1509

DIMENSIONS

Width	26¼-29¼	Seat Height	22¼-29	Arm Height	31¼-41¼	Weight	57
Depth	26	Seat Depth	17	Back Height	19¼	Cubic Ft.	20.4
Height	39¼-47¼	Seat Width	20¼	Back Width	17		



Height, Width Adjustable
Wood Arm

MIX-IT PRODUCT SPECIFICATIONS N12/N13/N14 SERIES

SEAT CONSTRUCTION

- Recycled plastic inner seat shell designed with a deep ribbing pattern to ensure rigidity
- Seats feature 2½" of custom molded controlled density polyurethane foam for consistency and good contoured support on all models

BACK CONSTRUCTION

- Injection molded polypropylene outer shell
- Blow molded polyethylene inner back shell designed with a deep ribbing to ensure rigidity
- Backs feature 1¾" of custom molded, controlled density polyurethane foam for consistency and good contoured support on all models

BACK REST

- Back height can be adjusted by simply lifting up on the back
- Adjusts 6 position within a range of approximately 2¾"

ADJUSTABLE ARMS

- Attached to the seat with metal brackets and screws; encased uprights are made of reinforced nylon
- Adjusts 8 positions in height within a 4" range
- Adjusts 5 positions in width and a 4" range for optimum comfort

STATIC ARMS

- Static arms have twin ⅞" x 16-gauge tubular steel uprights
- Seat and arm mounting components are made of ⅞" x 1" steel plates

HIGH PERFORMANCE ARMS

- Adjusts 10 positions in height within a 4" range
- Width adjustment allows arms to adjust within a 3" range
- Arm pad features depth, width and pivot adjustment
- Encased uprights are made of reinforced nylon

ARM PADS

- N12 Series models feature a soft polyurethane cap
- N13 and N14 Series models feature a soft polyurethane cap protecting a hard maple laminated wood detail; the N14 Series guest chairs also feature kiln dried exterior hard maple arms

CONTROL MECHANISM—SYNCHRONOUS TILT

- Synchronous tilt control allows the back and seat to move in a synchronized 2.3:1 ratio motion
- Free float feature allows the chair to tilt freely
- A side activated telescoping tension adjustment handle provides a comfortable way to adjust back tension to meet individual needs
- The back angle can be locked in one of five positions
- Standard pneumatic gas cylinder lift allows seat to raise and lower 4¼" and provides spring action for added comfort
- Seat/Slide option adjusts seat depth within a 2½" range

CONTROL MECHANISM—KNEE TILT

- Standard knee tilt mechanism features heavy-duty adjustable tension spring for a variety of body sizes and minimal rise of front seat edge; this allows the user's feet to remain planted when chair is in a reclining position
- The combination gas lift/tilt lock lever allows dual function with simple in/out movement for lockout and up/down movement for height adjustment

LIFT

- Pneumatic gas cylinder lift allows seat to raise and lower 5" and provides spring action for added comfort; finger grip lever adjustment is quick and easy

BASE AND CASTERS

- N12 and N13 Series models feature a five-prong black glass filled nylon for beauty and a long life
- N14 Series models feature a wood base with a standard five prong, rigid steel understructure to ensure a long life; decorative hardwood caps complement the chair design
- All bases have black, hard double wheel casters, which work on multiple surfaces
- Black, soft double wheel casters are available for use on hard floors; upcharge applies to this option
- Platinum Metallic option models feature a cast aluminum base

GLIDES

- Black nylon ball glides are standard
- For rough textured or soft surface flooring, we recommend using soft glides, contact customer service for pricing and availability

FINISH AND PAINT

- Wood finish features a catalyzed top coat which resists denting, peeling; can be cleaned with a damp cloth
- Metal paint features an electrostatically baked on black textured powder coat or smooth Platinum Metallic; can be cleaned with a damp cloth

WOOD SPECIES (N13, N14 SERIES)

- Hard maple

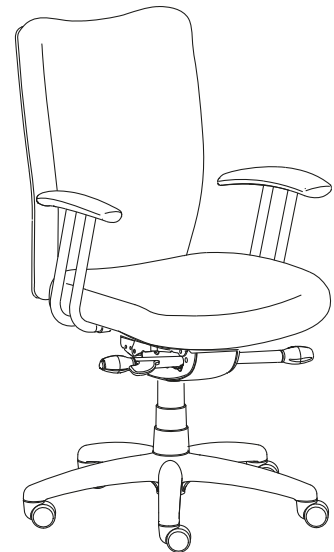

All Mix-it models may be ordered to meet TB133 fire code.

To order seating to meet the TB133 fire code, specify an "F" at the end of the model number (Ex: N12CCYF).

Reference pages 453-477 for TB133 Fabric Matrix and pricing.

Please consult customer service for applicable Arc-Com, COM, Maharam, Momentum, Stinson or Ultrafabrics fabric.

FABRICS

Grade 1	American Graffiti
	Cali
	Plush
	Ridge
	Stardust
Grade 2	COM
	Orbit
	Pixie
	Sedona
	Shenanigans
	Spectrum
	Strand*
	Twilight

Grade 3	Boardwalk
	COL
	Jacks
	Pop Rocks
Grade 4	Bumble
	Connect Four
	Echo
	Silvertex
Grade 5	Mode

Grade 6	Essence/Ultraleather
	Flock
	Scribe
Grade 7	Brisa
	Brisa Distressed
	Promessa
	Silica
Grade L7	Davenport
Grade L8	Showcase

*Strand restricted on upholstered back models

FINISHES

AC	Autumn	MH	Mocha
AD	Almond	NM	Natural
CL	Caramel	PB	Portobello
CW	Cordovan	TF	Truffle
DW	Judicial	405	Designer White
HN	Honey	462	Cinder
IM	Brighton	792	Sable
MC	Amber	793	Acorn

CASTERS

FOR BLACK BASE

C15	Hard (standard)
C2	Soft (add \$25 list)

FOR PLATINUM BASE

C1	Hard (standard)
C2	Soft (add \$25 list)

FOR WOOD BASE

C3	Hard (standard)
C4	Soft (add \$25 list)

TO ORDER, SPECIFY:

1. Model Number
 2. Fabric Grade Number
 3. Cover Number
 4. Finish Designator
 5. Casters
- See page 291 for Mix-it options

**MID BACK
ARMLESS
KNEE TILT
PLASTIC BASE**



MODEL NO.		GRADE / LIST PRICE									
		1	2/COM	3/COL	4	5	6	7	L7	L8	
N12AR	Plastic Back	\$ 701	729	742	761	783	821	870	1107	1182	
N12ARS	Plastic Back/Seatslide	796	824	837	856	878	916	965	1202	1277	
N12BR	Upholstered Back	728	763	779	803	830	878	940	1235	1330	
N12BRS	Upholstered Back/Seatslide	824	859	875	899	926	974	1036	1331	1426	

DIMENSIONS

Width	26¼	Seat Height	16-20	Back Height	19-21½	Weight	53
Depth	26	Seat Height with Seatslide	16½-20½	Back Width	18	Weight with Seatslide	56
Depth with Seatslide	25¼-26¾	Seat Depth	16¾			Cubic Ft.	18.3
Height	32-41¾	Seat Depth with Seatslide	16¾-19¼				
Height with Seatslide	32½-42¼	Seat Width	20¼				

• Platinum Metallic option – specify P (i.e., N12ARP) available for a \$133 list upcharge

**MID BACK
STATIC ARM
KNEE TILT
PLASTIC BASE**



MODEL NO.		GRADE / LIST PRICE									
		1	2/COM	3/COL	4	5	6	7	L7	L8	
N12CR	Plastic Back	\$ 856	884	897	916	938	976	1025	1262	1337	
N12CRS	Plastic Back/Seatslide	951	979	992	1011	1033	1071	1120	1357	1432	
N12DR	Upholstered Back	888	923	939	963	990	1038	1100	1395	1490	
N12DRS	Upholstered Back/Seatslide	983	1018	1034	1058	1085	1133	1195	1490	1585	

DIMENSIONS

Width	26¼	Seat Height	16-20	Arm Height	26½-30	Weight	63
Depth	26	Seat Height with Seatslide	16½-20½	Back Height	19-21½	Weight with Seatslide	66
Depth with Seatslide	25¼-26¾	Seat Depth	16¾	Back Width	18	Cubic Ft.	18.3
Height	32-41¾	Seat Depth with Seatslide	16¾-19¼				
Height with Seatslide	32½-42¼	Seat Width	20¼				

• Platinum Metallic option – specify P (i.e., N12CRP) available for a \$133 list upcharge



**MID BACK
HEIGHT ADJUSTABLE ARM
KNEE TILT
PLASTIC BASE**



Height Adjustable Arm

MODEL NO.

GRADE / LIST PRICE

			1	2/COM	3/COL	4	5	6	7	L7	L8
N12TR	Plastic Back	\$	851	879	892	911	933	971	1020	1257	1332
N12TRS	Plastic Back/Seatslide		945	973	986	1005	1027	1065	1114	1351	1426
N12KT	Upholstered Back		880	915	931	955	982	1030	1092	1387	1482
N12KTS	Upholstered Back/Seatslide		978	1013	1029	1053	1080	1128	1190	1485	1580

DIMENSIONS

Width	Seat Height	16-20	Arm Height	Weight
Depth	Seat Height with		Back Height	Weight with
Depth with	Seatslide	16½-20	Back Width	Seatslide
Seatslide	Seat Depth			Cubic Ft.
Height	Seat Depth with			
Height with	Seatslide			
Seatslide	Seat Width			

• Platinum Metallic option – specify P (i.e., N12TRP) available for a \$133 list upcharge

**MID BACK
HEIGHT, WIDTH
ADJUSTABLE ARM
KNEE TILT
PLASTIC BASE**



Height, Width Adjustable Arm

			1	2/COM	3/COL	4	5	6	7	L7	L8
N12JR	Plastic Back	\$	877	905	918	937	959	997	1046	1283	1358
N12JRS	Plastic Back/Seatslide		971	999	1012	1031	1053	1091	1140	1377	1452
N12KR	Upholstered Back		905	940	956	980	1007	1055	1117	1412	1507
N12KRS	Upholstered Back/Seatslide		1003	1038	1054	1078	1105	1153	1215	1510	1605

DIMENSIONS

Width	26¼-29¼	Seat Height	16-20	Arm Height	25¼-32	Weight	58
Depth	26	Seat Height with		Back Height	19-21½	Weight with	Seatslide
Depth with	Seatslide	Seatslide	16½-20½	Back Width	18	Seatslide	61
Seatslide	25¼-26¾	Seat Depth	16¾			Cubic Ft.	18.3
Height	32-41¾	Seat Depth with					
Height with	Seatslide	Seatslide	16¾-19¼				
Seatslide	32½-42¼	Seat Width	20¼				

• Platinum Metallic option – specify P (i.e., N12JRP) available for a \$133 list upcharge

**MID BACK
HIGH PERFORMANCE ARM
KNEE TILT
PLASTIC BASE**



High Performance Arm

			1	2/COM	3/COL	4	5	6	7	L7	L8
N12JRE	Plastic Back	\$	987	1015	1028	1047	1069	1107	1156	1393	1468
N12JRES	Plastic Back/Seatslide		1081	1109	1122	1141	1163	1201	1250	1487	1562
N12KRE	Upholstered Back		1015	1050	1066	1090	1117	1165	1227	1522	1617
N12KRES	Upholstered Back/Seatslide		1113	1148	1164	1188	1215	1263	1325	1620	1715

DIMENSIONS

Width	26¼-29¼	Seat Height	16-20	Arm Height	24¾-32½	Weight	58
Depth	26	Seat Height with		Back Height	19-21½	Weight with	Seatslide
Depth with	Seatslide	Seatslide	16½-20½	Back Width	18	Seatslide	61
Seatslide	25¼-26¾	Seat Depth	16¾			Cubic Ft.	18.3
Height	32-41¾	Seat Depth with					
Height with	Seatslide	Seatslide	16¾-19¼				
Seatslide	32½-42¼	Seat Width	20¼				

• Platinum Metallic option – specify P (i.e., N12JREP) available for a \$133 list upcharge

TO ORDER, SPECIFY:

1. Model Number
 2. Fabric Grade Number
 3. Cover Number
 4. Finish Designator
 5. Casters
- See page 291 for Mix-it options

**MID BACK
STATIC WOOD ARM
KNEE TILT
PLASTIC BASE**



Static Wood Arm

MODEL NO.		GRADE / LIST PRICE									
		1	2/COM	3/COL	4	5	6	7	L7	L8	
N13CR	Plastic Back	\$ 950	978	991	1010	1032	1070	1119	1356	1431	
N13CRS	Plastic Back/Seatslide	1044	1072	1085	1104	1126	1164	1213	1450	1525	
N13DR	Upholstered Back	981	1016	1032	1056	1083	1131	1193	1488	1583	
N13DRS	Upholstered Back/Seatslide	1076	1111	1127	1151	1178	1226	1288	1583	1678	

DIMENSIONS

Width	26¼	Seat Height	16-20	Arm Height	26½-30	Weight	55
Depth	26	Seat Height with Seatslide	16½-20½	Back Height	19-21½	Weight with Seatslide	58
Depth with Seatslide	25¼-26¾	Seat Depth	16¾	Back Width	18	Cubic Ft.	18.3
Height	32-41¾	Seat Depth with Seatslide	16¾-19¼				
Height with Seatslide	32½-42¼	Seat Width	20¼				

- Platinum Metallic option – specify P (i.e., N13CRP) available for a \$133 list upcharge

**MID BACK
HEIGHT ADJUSTABLE
WOOD ARM
KNEE TILT
PLASTIC BASE**



Height Adjustable Wood Arm

MODEL NO.		GRADE / LIST PRICE									
		1	2/COM	3/COL	4	5	6	7	L7	L8	
N13TR	Plastic Back	\$ 946	974	987	1006	1028	1066	1115	1352	1427	
N13TRS	Plastic Back/Seatslide	1042	1070	1083	1102	1124	1162	1211	1448	1523	
N13KT	Upholstered Back	978	1013	1029	1053	1080	1128	1190	1485	1580	
N13KTS	Upholstered Back/Seatslide	1075	1110	1126	1150	1177	1225	1287	1582	1677	

DIMENSIONS

Width		Seat Height	16-20	Arm Height		Weight	
Depth		Seat Height with Seatslide	16½-20½	Back Height		Weight with Seatslide	
Depth with Seatslide		Seat Depth		Back Width		Cubic Ft.	
Height		Seat Depth with Seatslide					
Height with Seatslide		Seat Width					

- Platinum Metallic option not available

**MID BACK
HEIGHT, WIDTH
ADJUSTABLE WOOD ARM
KNEE TILT
PLASTIC BASE**



Height, Width Adjustable
Wood Arm

			1	2/COM	3/COL	4	5	6	7	L7	L8
N13JR	Plastic Back	\$	972	1000	1013	1032	1054	1092	1141	1378	1453
N13JRS	Plastic Back/Seatslide		1068	1096	1109	1128	1150	1188	1237	1474	1549
N13KR	Upholstered Back		1003	1038	1054	1078	1105	1153	1215	1510	1605
N13KRS	Upholstered Back/Seatslide		1100	1135	1151	1175	1202	1250	1312	1607	1702

DIMENSIONS

Width	26¼-29¼	Seat Height	16-20	Arm Height	25¼-32	Weight	59
Depth	26	Seat Height with		Back Height	19-21½	Weight with	
Depth with		Seatslide	16½-20½	Back Width	18	Seatslide	62
Seatslide	25¼-26¾	Seat Depth	16¾			Cubic Ft.	18.3
Height	32-41¾	Seat Depth with					
Height with		Seatslide	16¾-19¼				
Seatslide	32½-42¼	Seat Width	20¼				

• Platinum Metallic option not available

**MID BACK
ARMLESS
SYNCHRONOUS
PLASTIC BASE**



			1	2/COM	3/COL	4	5	6	7	L7	L8
N12AAC	Plastic Back	\$	784	812	825	844	866	904	953	1190	1265
N12AACS	Plastic Back/Seatslide		879	907	920	939	961	999	1048	1285	1360
N12BBC	Upholstered Back		811	846	862	886	913	961	1023	1318	1413
N12BBCS	Upholstered Back/Seatslide		907	942	958	982	1009	1057	1119	1414	1509

DIMENSIONS

Width	26¼	Seat Height	17¼-22¼	Back Height	19-21½	Weight	50.2
Depth	26	Seat Height with		Back Width	18	Weight with	
Depth with		Seatslide	17¾-22¾			Seatslide	53.8
Seatslide	25¼-26½	Seat Depth	16¾			Cubic Ft.	18.3
Height	35½-43½	Seat Depth with					
Height with		Seatslide	16½-18¾				
Seatslide	36¼-44¼	Seat Width	20¼				

• Platinum Metallic option – specify P (i.e., N12AACP) available for a \$133 list upcharge

**MID BACK
STATIC ARM
SYNCHRONOUS
PLASTIC BASE**



Static Arm

			1	2/COM	3/COL	4	5	6	7	L7	L8
N12CCC	Plastic Back	\$	939	967	980	999	1021	1059	1108	1345	1420
N12CCCS	Plastic Back/Seatslide		1034	1062	1075	1094	1116	1154	1203	1440	1515
N12DDC	Upholstered Back		970	1005	1021	1045	1072	1120	1182	1477	1572
N12DDCS	Upholstered Back/Seatslide		1066	1101	1117	1141	1168	1216	1278	1573	1668

DIMENSIONS

Width	26¼	Seat Height	17¼-22¼	Arm Height	27¼-32¼	Weight	60
Depth	26	Seat Height with		Back Height	19-21½	Weight with	
Depth with		Seatslide	17¾-22¾	Back Width	18	Seatslide	63.6
Seatslide	25¼-26½	Seat Depth	16¾			Cubic Ft.	18.3
Height	35½-43½	Seat Depth with					
Height with		Seatslide	16½-18¾				
Seatslide	36¼-44¼	Seat Width	20¼				

• Platinum Metallic option – specify P (i.e., N12CCCP) available for a \$133 list upcharge

Mix-it

To You In 10 DAYS ...or Less
 Shaded model numbers are available on our "To You in 10 Days or Less" Quick Delivery program and will be delivered within 10 days.

TO ORDER, SPECIFY:

1. Model Number
 2. Fabric Grade Number
 3. Cover Number
 4. Finish Designator
 5. Casters
- See page 291 for Mix-it options

MID BACK HEIGHT ADJUSTABLE ARM SYNCHRONOUS PLASTIC BASE



Height Adjustable Arm

MODEL NO.

GRADE / LIST PRICE

Quick Delivery Models: QN12TJC, QN12JCS

		1	2/COM	3/COL	4	5	6	7	L7	L8
N12TJC	Plastic Back	\$ 934	962	975	994	1016	1054	1103	1340	1415
N12TJCS	Plastic Back/Seatslide	1029	1057	1070	1089	1111	1149	1198	1435	1510
N12KTC	Upholstered Back	964	999	1015	1039	1066	1114	1176	1471	1566
N12KTCS	Upholstered Back/Seatslide	1061	1096	1112	1136	1163	1211	1273	1568	1663

DIMENSIONS

Width	Seat Height	17¼-22¼	Arm Height	Weight
Depth	Seat Height with		Back Height	Weight with
Depth with	Seatslide	17¾-22¾	Back Width	Seatslide
Seatslide	Seat Depth			Cubic Ft.
Height	Seat Depth with			
Height with	Seatslide			
Seatslide	Seat Width			

• Platinum Metallic option – specify P (i.e., N12TJCP) available for a \$133 list upcharge

MID BACK HEIGHT, WIDTH ADJUSTABLE ARM SYNCHRONOUS PLASTIC BASE



Height, Width Adjustable Arm

Quick Delivery Models: QN12JJC, QN12JCS

		1	2/COM	3/COL	4	5	6	7	L7	L8
N12JJC	Plastic Back	\$ 960	988	1001	1020	1042	1080	1129	1366	1441
N12JJCS	Plastic Back/Seatslide	1054	1082	1095	1114	1136	1174	1223	1460	1535
N12KKC	Upholstered Back	989	1024	1040	1064	1091	1139	1201	1496	1591
N12KKCS	Upholstered Back/Seatslide	1086	1121	1137	1161	1188	1236	1298	1593	1688

DIMENSIONS

Width	26¼-29¼	Seat Height	17¼-22¼	Arm Height	26-34	Weight	55.8
Depth	26	Seat Height with		Back Height	19-21½	Weight with	
Depth with		Seatslide	17¾-22¾	Back Width	18	Seatslide	59.4
Seatslide	25¼-26½	Seat Depth	16¾			Cubic Ft.	18.3
Height	35½-43½	Seat Depth with					
Height with		Seatslide	16½-18¾				
Seatslide	36¼-44¼	Seat Width	20¼				

• Platinum Metallic option – specify P (i.e., N12JJCP) available for a \$133 list upcharge

**MID BACK
HIGH PERFORMANCE ARM
SYNCHRONOUS
PLASTIC BASE**



High Performance Arm

**MODEL
NO.**

GRADE / LIST PRICE

Quick Delivery Models: QN12JJCE, QN12JJCES

			1	2/COM	3/COL	4	5	6	7	L7	L8
N12JJCE	Plastic Back	\$	1070	1098	1111	1130	1152	1190	1239	1476	1551
N12JJCES	Plastic Back/Seatslide		1166	1194	1207	1226	1248	1286	1335	1572	1647
N12KKCE	Upholstered Back		1099	1134	1150	1174	1201	1249	1311	1606	1701
N12KKCES	Upholstered Back/Seatslide		1198	1233	1249	1273	1300	1348	1410	1705	1800

DIMENSIONS

Width	26¼-29¼	Seat Height	17¼-22¼	Arm Height	25½-34½	Weight	55.8
Depth	26	Seat Height with		Back Height	19-21½	Weight with	
Depth with		Seatslide	17¼-22¼	Back Width	18	Seatslide	59.4
Seatslide	25¼-26½	Seat Depth	16¾			Cubic Ft.	18.3
Height	35½-43½	Seat Depth with					
Height with		Seatslide	16½-18¾				
Seatslide	36¼-44¼	Seat Width	20¼				

• Platinum Metallic option – specify P (i.e., N12JJCEP) available for a \$133 list upcharge

**MID BACK
STATIC WOOD ARM
SYNCHRONOUS
PLASTIC BASE**



Static Wood Arm

			1	2/COM	3/COL	4	5	6	7	L7	L8
N13CCC	Plastic Back	\$	1033	1061	1074	1093	1115	1153	1202	1439	1514
N13CCCS	Plastic Back/Seatslide		1129	1157	1170	1189	1211	1249	1298	1535	1610
N13DDC	Upholstered Back		1065	1100	1116	1140	1167	1215	1277	1572	1667
N13DDCS	Upholstered Back/Seatslide		1158	1193	1209	1233	1260	1308	1370	1665	1760

DIMENSIONS

Width	26¼	Seat Height	17¼-22¼	Arm Height	27-32	Weight	51.9
Depth	26	Seat Height with		Back Height	19-21½	Weight with	
Depth with		Seatslide	17¼-22¼	Back Width	18	Seatslide	55.5
Seatslide	25¼-26½	Seat Depth	16¾			Cubic Ft.	18.3
Height	35½-43½	Seat Depth with					
Height with		Seatslide	16½-18¾				
Seatslide	36¼-44¼	Seat Width	20¼				

• Platinum Metallic option – specify P (i.e., N13CCCP) available for a \$133 list upcharge

**MID BACK
HEIGHT ADJUSTABLE
WOOD ARM
SYNCHRONOUS
PLASTIC BASE**



Height Adjustable Wood Arm

			1	2/COM	3/COL	4	5	6	7	L7	L8
N13TJC	Plastic Back	\$	1030	1058	1071	1090	1112	1150	1199	1436	1511
N13TJCS	Plastic Back/Seatslide		1124	1152	1165	1184	1206	1244	1293	1530	1605
N13KTC	Upholstered Back		1061	1096	1112	1136	1163	1211	1273	1568	1663
N13KTCS	Upholstered Back/Seatslide		1156	1191	1207	1231	1258	1306	1368	1663	1758

DIMENSIONS

Width		Seat Height	17¼-22¼	Arm Height		Weight	
Depth		Seat Height with		Back Height		Weight with	
Depth with		Seatslide	17¼-22¼	Back Width		Seatslide	
Seatslide		Seat Depth				Cubic Ft.	
Height		Seat Depth with					
Height with		Seatslide					
Seatslide		Seat Width					

• Platinum Metallic option not available

TO ORDER, SPECIFY:

1. Model Number
 2. Fabric Grade Number
 3. Cover Number
 4. Finish Designator
 5. Casters
- See page 291 for Mix-it options

**MID BACK
HEIGHT, WIDTH
ADJUSTABLE WOOD ARM
SYNCHRONOUS
PLASTIC BASE**



Height, Width Adjustable
Wood Arm

MODEL NO.	GRADE / LIST PRICE										
		1	2/COM	3/COL	4	5	6	7	L7	L8	
N13JJC	Plastic Back	\$ 1055	1083	1096	1115	1137	1175	1224	1461	1536	
N13JCS	Plastic Back/Seatslide	1149	1177	1190	1209	1231	1269	1318	1555	1630	
N13KCC	Upholstered Back	1086	1121	1137	1161	1188	1236	1298	1593	1688	
N13KCS	Upholstered Back/Seatslide	1182	1217	1233	1257	1284	1332	1394	1689	1784	

DIMENSIONS

Width	26¼	Seat Height	17¼-22¼	Arm Height	25½-33¼	Weight	55.9
Depth	26	Seat Height with Seatslide	17¾-22¾	Back Height	19-21½	Weight with Seatslide	59.5
Depth with Seatslide	25¼-26½	Seat Depth	16¾	Back Width	18	Cubic Ft.	18.3
Height	35½-43½	Seat Depth with Seatslide	16½-18¾				
Height with Seatslide	36¼-44¼	Seat Width	20¼				

- Platinum Metallic option not available

**HIGH BACK
STATIC ARM
KNEE TILT
PLASTIC BASE**



Static Arm

MODEL NO.	GRADE / LIST PRICE										
		1	2/COM	3/COL	4	5	6	7	L7	L8	
N12ER	Plastic Back	\$ 886	916	930	951	974	1016	1069	1325	1407	
N12ERS	Plastic Back/Seatslide	980	1010	1024	1045	1068	1110	1163	1419	1501	
N12HR	Upholstered Back	916	953	970	996	1025	1076	1142	1457	1558	
N12HRS	Upholstered Back/Seatslide	1010	1047	1064	1090	1119	1170	1236	1551	1652	

DIMENSIONS

Width	26¼	Seat Height	16-20	Arm Height	26½-30	Weight	66
Depth	26	Seat Height with Seatslide	16½-20½	Back Height	22-24½	Weight with Seatslide	70
Depth with Seatslide	25¼-26¾	Seat Depth	16¾	Back Width	18½	Cubic Ft.	19.1
Height	35¼-46½	Seat Depth with Seatslide	16¾-19¼				
Height with Seatslide	36¼-46	Seat Width	20¼				

- Platinum Metallic option – specify P (i.e., N12ERP) available for a \$133 list upcharge

**HIGH BACK
HEIGHT ADJUSTABLE ARM
KNEE TILT
PLASTIC BASE**



Height Adjustable Arm

MODEL NO.

GRADE / LIST PRICE

			1	2/COM	3/COL	4	5	6	7	L7	L8
N12MT	Plastic Back	\$	878	908	922	943	966	1008	1061	1317	1399
N12MTS	Plastic Back/Seatslide		975	1005	1019	1040	1063	1105	1158	1414	1496
N12PT	Upholstered Back		908	945	962	988	1017	1068	1134	1449	1550
N12PTS	Upholstered Back/Seatslide		1005	1042	1059	1085	1114	1165	1231	1546	1647

DIMENSIONS

Width	Seat Height	16-20	Arm Height	Weight
Depth	Seat Height with		Back Height	Weight with
Depth with	Seatslide	16½-20½	Back Width	Seatslide
Seatslide	Seat Depth			Cubic Ft.
Height	Seat Depth with			
Height with	Seatslide			
Seatslide	Seat Width			

• Platinum Metallic option – specify P (i.e., N12MTP) available for a \$133 list upcharge

**HIGH BACK
HEIGHT, WIDTH
ADJUSTABLE ARM
KNEE TILT
PLASTIC BASE**



Height, Width Adjustable Arm

			1	2/COM	3/COL	4	5	6	7	L7	L8
N12MR	Plastic Back	\$	903	933	947	968	991	1033	1086	1342	1424
N12MRS	Plastic Back/Seatslide		1000	1030	1044	1065	1088	1130	1183	1439	1521
N12PR	Upholstered Back		933	970	987	1013	1042	1093	1159	1474	1575
N12PRS	Upholstered Back/Seatslide		1030	1067	1084	1110	1139	1190	1256	1571	1672

DIMENSIONS

Width	26¼-29¼	Seat Height	16-20	Arm Height	25¼-32	Weight	64
Depth	26	Seat Height with		Back Height	22-24½	Weight with	Seatslide
Depth with		Seatslide	16½-20½	Back Width	18½	Seatslide	67
Seatslide	25¼-26¾	Seat Depth	16¾			Cubic Ft.	19.1
Height	35¾-45½	Seat Depth with					
Height with		Seatslide	16¾-19¼				
Seatslide	36¼-46	Seat Width	20¼				

• Platinum Metallic option – specify P (i.e., N12MRP) available for a \$133 list upcharge

**HIGH BACK
HIGH PERFORMANCE ARM
KNEE TILT
PLASTIC BASE**



High Performance Arm

			1	2/COM	3/COL	4	5	6	7	L7	L8
N12MRE	Plastic Back	\$	1013	1043	1057	1078	1101	1143	1196	1452	1534
N12MRES	Plastic Back/Seatslide		1110	1140	1154	1175	1198	1240	1293	1549	1631
N12PRE	Upholstered Back		1043	1080	1097	1123	1152	1203	1269	1584	1685
N12PRES	Upholstered Back/Seatslide		1140	1177	1194	1220	1249	1300	1366	1681	1782

DIMENSIONS

Width	26¼-29¼	Seat Height	16-20	Arm Height	24¾-32½	Weight	64
Depth	26	Seat Height with		Back Height	22-24½	Weight with	Seatslide
Depth with		Seatslide	16½-20½	Back Width	18½	Seatslide	67
Seatslide	25¼-26¾	Seat Depth	16¾			Cubic Ft.	19.1
Height	35¾-45½	Seat Depth with					
Height with		Seatslide	16¾-19¼				
Seatslide	36¼-46	Seat Width	20¼				

• Platinum Metallic option – specify P (i.e., N12MREP) available for a \$133 list upcharge

TO ORDER, SPECIFY:

1. Model Number
 2. Fabric Grade Number
 3. Cover Number
 4. Finish Designator
 5. Casters
- See page 291 for Mix-it options

**HIGH BACK
STATIC WOOD ARM
KNEE TILT
PLASTIC BASE**



Static Wood Arm

MODEL NO.		GRADE / LIST PRICE									
		1	2/COM	3/COL	4	5	6	7	L7	L8	
N13ER	Plastic Back	\$ 979	1009	1023	1044	1067	1109	1162	1418	1500	
N13ERS	Plastic Back/Seatslide	1074	1104	1118	1139	1162	1204	1257	1513	1595	
N13HR	Upholstered Back	1009	1046	1063	1089	1118	1169	1235	1550	1651	
N13HRS	Upholstered Back/Seatslide	1105	1142	1159	1185	1214	1265	1331	1646	1747	

DIMENSIONS

Width	26¼	Seat Height	16-20	Arm Height	26½-30	Weight	64
Depth	26	Seat Height with		Back Height	22-24½	Weight with	
Depth with		Seatslide	16½-20½	Back Width	18½	Seatslide	67
Seatslide	25¼-26¾	Seat Depth	16¾			Cubic Ft.	19.1
Height	35¾-45½	Seat Depth with					
Height with		Seatslide	16¾-19¼				
Seatslide	36¼-46	Seat Width	20¾				

- Platinum Metallic option – specify P (i.e., N13ERP) available for a \$133 list upcharge

**HIGH BACK
HEIGHT ADJUSTABLE
WOOD ARM
KNEE TILT
PLASTIC BASE**



Height Adjustable Wood Arm

MODEL NO.		GRADE / LIST PRICE									
		1	2/COM	3/COL	4	5	6	7	L7	L8	
N13MT	Plastic Back	\$ 975	1005	1019	1040	1063	1105	1158	1414	1496	
N13MTS	Plastic Back/Seatslide	1069	1099	1113	1134	1157	1199	1252	1508	1590	
N13PT	Upholstered Back	1006	1043	1060	1086	1115	1166	1232	1547	1648	
N13PTS	Upholstered Back/Seatslide	1104	1141	1158	1184	1213	1264	1330	1645	1746	

DIMENSIONS

Width		Seat Height	16-20	Arm Height		Weight	
Depth		Seat Height with		Back Height		Weight with	
Depth with		Seatslide	16½-20½	Back Width		Seatslide	
Seatslide		Seat Depth				Cubic Ft.	
Height		Seat Depth with					
Height with		Seatslide					
Seatslide		Seat Width					

- Platinum Metallic option not available

**HIGH BACK
HEIGHT, WIDTH
ADJUSTABLE WOOD ARM
KNEE TILT
PLASTIC BASE**



Height, Width Adjustable
Wood Arm

**MODEL
NO.**

GRADE / LIST PRICE

		1	2/COM	3/COL	4	5	6	7	L7	L8
N13MR	Plastic Back	\$ 1000	1030	1044	1065	1088	1130	1183	1439	1521
N13MRS	Plastic Back/Seatslide	1094	1124	1138	1159	1182	1224	1277	1533	1615
N13PR	Upholstered Back	1031	1068	1085	1111	1140	1191	1257	1572	1673
N13PRS	Upholstered Back/Seatslide	1129	1166	1183	1209	1238	1289	1355	1670	1771

DIMENSIONS

Width	26¼-29¼	Seat Height	16-20	Arm Height	25¼-32	Weight	64
Depth	26	Seat Height with		Back Height	22-24½	Weight with	
Depth with		Seatslide	16½-20½	Back Width	18½	Seatslide	67
Seatslide	25¼-26¾	Seat Depth	16¾			Cubic Ft.	19.1
Height	35¾-45½	Seat Depth with					
Height with		Seatslide	16¼-19¼				
Seatslide	36¼-46	Seat Width	20¼				

• Platinum Metallic option not available

**HIGH BACK
STATIC ARM
SYNCHRONOUS
PLASTIC BASE**



Static Arm

		1	2/COM	3/COL	4	5	6	7	L7	L8
N12EEC	Plastic Back	\$ 968	998	1012	1033	1056	1098	1151	1407	1489
N12EES	Plastic Back/Seatslide	1064	1094	1108	1129	1152	1194	1247	1503	1585
N12HHC	Upholstered Back	999	1036	1053	1079	1108	1159	1225	1540	1641
N12HCS	Upholstered Back/Seatslide	1095	1132	1149	1175	1204	1255	1321	1636	1737

DIMENSIONS

Width	26¼	Seat Height	17¼-22¼	Arm Height	27¼-32¼	Weight	63.5
Depth	26	Seat Height with		Back Height	22-24½	Weight with	
Depth with		Seatslide	17¾-22¾	Back Width	18½	Seatslide	67.1
Seatslide	25¼-26¾	Seat Depth	16¾			Cubic Ft.	19.1
Height	39¼-47¼	Seat Depth with					
Height with		Seatslide	16½-18¾				
Seatslide	40-48	Seat Width	20¼				

• Platinum Metallic option – specify P (i.e., N12EECP) available for a \$133 list upcharge

**HIGH BACK
HEIGHT ADJUSTABLE ARM
SYNCHRONOUS
PLASTIC BASE**

Quick Delivery Model: QN12TMCS



Height Adjustable Arm

		1	2/COM	3/COL	4	5	6	7	L7	L8
N12TMC	Plastic Back	\$ 961	991	1005	1026	1049	1091	1144	1400	1482
N12TMCS	Plastic Back/Seatslide	1056	1086	1100	1121	1144	1186	1239	1495	1577
N12TPC	Upholstered Back	991	1028	1045	1071	1100	1151	1217	1532	1633
N12TPCS	Upholstered Back/Seatslide	1087	1124	1141	1167	1196	1247	1313	1628	1729

DIMENSIONS

Width		Seat Height	17¼-22¼	Arm Height		Weight	
Depth		Seat Height with		Back Height		Weight with	
Depth with		Seatslide	17¾-22¾	Back Width		Seatslide	
Seatslide		Seat Depth				Cubic Ft.	
Height		Seat Depth with					
Height with		Seatslide					
Seatslide		Seat Width					

• Platinum Metallic option – specify P (i.e., N12TMCP) available for a \$133 list upcharge

To You In 10 DAYS ...or Less
 Shaded model numbers are available on our "To You in 10 Days or Less" Quick Delivery program and will be delivered within 10 days.

TO ORDER, SPECIFY:

1. Model Number
 2. Fabric Grade Number
 3. Cover Number
 4. Finish Designator
 5. Casters
- See page 291 for Mix-it options

**HIGH BACK
 HEIGHT, WIDTH
 ADJUSTABLE ARM
 SYNCHRONOUS
 PLASTIC BASE**



Height, Width Adjustable Arm

MODEL NO.

GRADE / LIST PRICE

Quick Delivery Model: QN12MMCS

		1	2/COM	3/COL	4	5	6	7	L7	L8
N12MMC	Plastic Back	\$ 986	1016	1030	1051	1074	1116	1169	1425	1507
N12MMCS	Plastic Back/Seatslide	1082	1112	1126	1147	1170	1212	1265	1521	1603
N12PPC	Upholstered Back	1016	1053	1070	1096	1125	1176	1242	1557	1658
N12PPCS	Upholstered Back/Seatslide	1112	1149	1166	1192	1221	1272	1338	1653	1754

DIMENSIONS

Width	26¼-29¼	Seat Height	17¼-22¼	Arm Height	26-34	Weight	61.3
Depth	26	Seat Height with Seatslide	17¾-22¾	Back Height	22-24½	Weight with Seatslide	64.9
Depth with Seatslide	25¼-26½	Seat Depth	16¾	Back Width	18½	Cubic Ft.	19.1
Height	39¼-47¼	Seat Depth with Seatslide	16½-18¾				
Height with Seatslide	40-48	Seat Width	20¼				

• Platinum Metallic option – specify P (i.e., N12MMCP) available for a \$133 list upcharge

**HIGH BACK
 HIGH PERFORMANCE ARM
 SYNCHRONOUS
 PLASTIC BASE**



High Performance Arm

Quick Delivery Model: QN12MMCES

		1	2/COM	3/COL	4	5	6	7	L7	L8
N12MMCE	Plastic Back	\$ 1097	1127	1141	1162	1185	1227	1280	1536	1618
N12MMCES	Plastic Back/Seatslide	1192	1222	1236	1257	1280	1322	1375	1631	1713
N12PPCE	Upholstered Back	1128	1165	1182	1208	1237	1288	1354	1669	1770
N12PPCES	Upholstered Back/Seatslide	1222	1259	1276	1302	1331	1382	1448	1763	1864

DIMENSIONS

Width	26¼-29¼	Seat Height	17¼-22¼	Arm Height	25½-34½	Weight	61.3
Depth	26	Seat Height with Seatslide	17¾-22¾	Back Height	22-24½	Weight with Seatslide	64.9
Depth with Seatslide	25¼-26½	Seat Depth	16¾	Back Width	18½	Cubic Ft.	19.1
Height	39¼-47¼	Seat Depth with Seatslide	16½-18¾				
Height with Seatslide	40-48	Seat Width	20¼				

• Platinum Metallic option – specify P (i.e., N12MMCEP) available for a \$133 list upcharge

**HIGH BACK
STATIC WOOD ARM
SYNCHRONOUS
PLASTIC BASE**



Static Wood Arm

**MODEL
NO.**

GRADE / LIST PRICE

		1	2/COM	3/COL	4	5	6	7	L7	L8
N13EEC	Plastic Back	\$ 1063	1093	1107	1128	1151	1193	1246	1502	1584
N13EECS	Plastic Back/Seatslide	1155	1185	1199	1220	1243	1285	1338	1594	1676
N13HHC	Upholstered Back	1094	1131	1148	1174	1203	1254	1320	1635	1736
N13HHCS	Upholstered Back/Seatslide	1187	1224	1241	1267	1296	1347	1413	1728	1829

DIMENSIONS

Width	26¼	Seat Height	17¼-22¼	Arm Height	26½-34½	Weight	61.4
Depth	26	Seat Height with		Back Height	22-24½	Weight with	
Depth with		Seatslide	17¾-22¾	Back Width	18½	Seatslide	65.0
Seatslide	25¼-26½	Seat Depth	16¾			Cubic Ft.	19.1
Height	39¼-47¼	Seat Depth with					
Height with		Seatslide	16½-18¾				
Seatslide	40-48	Seat Width	20¼				

• Platinum Metallic option – specify P (i.e., N13EECP) available for a \$133 list upcharge

**HIGH BACK
HEIGHT ADJUSTABLE
WOOD ARM
SYNCHRONOUS
PLASTIC BASE**



Height Adjustable Wood Arm

		1	2/COM	3/COL	4	5	6	7	L7	L8
N13TMC	Plastic Back	\$ 1056	1086	1100	1121	1144	1186	1239	1495	1577
N13TMCS	Plastic Back/Seatslide	1150	1180	1194	1215	1238	1280	1333	1589	1671
N13TPC	Upholstered Back	1088	1125	1142	1168	1197	1248	1314	1629	1730
N13TPCS	Upholstered Back/Seatslide	1186	1223	1240	1266	1295	1346	1412	1727	1828

DIMENSIONS

Width		Seat Height	17¼-22¼	Arm Height		Weight	
Depth		Seat Height with		Back Height		Weight with	
Depth with		Seatslide	17¾-22¾	Back Width		Seatslide	
Seatslide		Seat Depth				Cubic Ft.	
Height		Seat Depth with					
Height with		Seatslide					
Seatslide		Seat Width					

• Platinum Metallic option not available

**HIGH BACK
HEIGHT, WIDTH
ADJUSTABLE WOOD ARM
SYNCHRONOUS
PLASTIC BASE**



Height, Width Adjustable
Wood Arm

		1	2/COM	3/COL	4	5	6	7	L7	L8
N13MMC	Plastic Back	\$ 1082	1112	1126	1147	1170	1212	1265	1521	1603
N13MMCS	Plastic Back/Seatslide	1176	1206	1220	1241	1264	1306	1359	1615	1697
N13PPC	Upholstered Back	1113	1150	1167	1193	1222	1273	1339	1654	1755
N13PPCS	Upholstered Back/Seatslide	1211	1248	1265	1291	1320	1371	1437	1752	1853

DIMENSIONS

Width	26¼-29¼	Seat Height	17¼-22¼	Arm Height	25½-33¾	Weight	61.4
Depth	26	Seat Height with		Back Height	22-24½	Weight with	
Depth with		Seatslide	17¾-22¾	Back Width	18½	Seatslide	65.0
Seatslide	25¼-26½	Seat Depth	16¾			Cubic Ft.	19.1
Height	39¼-47¼	Seat Depth with					
Height with		Seatslide	16½-18¾				
Seatslide	40-48	Seat Width	20¼				

• Platinum Metallic option not available

To You In 10 DAYS ...or Less
 Shaded model numbers are available on our "To You in 10 Days or Less" Quick Delivery program and will be delivered within 10 days.

TO ORDER, SPECIFY:

1. Model Number
 2. Fabric Grade Number
 3. Cover Number
 4. Finish Designator
 5. Casters
- See page 291 for Mix-it options

GUEST POLYURETHANE ARMS



MODEL NO.

GRADE / LIST PRICE

Quick Delivery Models: QN12RR, QN12QQ

			1	2/COM	3/COL	4	5	6	7	L7	L8
N12RR	Plastic Back	\$	598	623	635	653	673	708	753	970	1039
N12QQ	Upholstered Back		628	660	676	698	723	768	825	1101	1189

DIMENSIONS

Width	24¾	Seat Height	18½	Arm Height	26¼	Weight	40
Depth	24	Seat Depth	18¼	Kneespace	20	Cubic Ft.	16.4
Height	35¼	Seat Width	20¾				

- Platinum Metallic option – specify P (i.e., N12RRP) available for a \$35 list upcharge

MID BACK ARMLESS KNEE TILT WOOD BASE



			1	2/COM	3/COL	4	5	6	7	L7	L8
N14AR	Plastic Back	\$	781	809	822	841	863	901	950	1187	1262
N14ARS	Plastic Back/Seatslide		878	906	919	938	960	998	1047	1284	1359
N14BR	Upholstered Back		813	848	864	888	915	963	1025	1320	1415
N14BRS	Upholstered Back/Seatslide		905	940	956	980	1007	1055	1117	1412	1507

DIMENSIONS

Width	26¼	Seat Height	16¼-20¼	Back Height	19-21½	Weight	58
Depth	26	Seat Height with Seatslide	16¾-20¾	Back Width	18	Weight with Seatslide	61
Depth with Seatslide	25¼-26¾	Seat Depth	16¾			Cubic Ft.	18.3
Height	32¼-42	Seat Depth with Seatslide	16¾-19¼				
Height with Seatslide	32¾-42½	Seat Width	20¾				

- Platinum Metallic option not available

**MID BACK
STATIC WOOD ARM
KNEE TILT
WOOD BASE**



Static Wood Arm

**MODEL
NO.**

GRADE / LIST PRICE

		1	2/COM	3/COL	4	5	6	7	L7	L8
N14CR	Plastic Back	\$ 1031	1059	1072	1091	1113	1151	1200	1437	1512
N14CRS	Plastic Back/Seatslide	1129	1157	1170	1189	1211	1249	1298	1535	1610
N14DR	Upholstered Back	1064	1099	1115	1139	1166	1214	1276	1571	1666
N14DRS	Upholstered Back/Seatslide	1156	1191	1207	1231	1258	1306	1368	1663	1758

DIMENSIONS

Width	26¼	Seat Height	16¼-20¼	Arm Height	26½-30	Weight	66
Depth	26	Seat Height with		Back Height	19-21½	Weight with	
Depth with		Seatslide	16¼-20¼	Back Width	18	Seatslide	69
Seatslide	25¼-26¾	Seat Depth	16¾			Cubic Ft.	18.3
Height	32¼-42	Seat Depth with					
Height with		Seatslide	16¾-19¼				
Seatslide	32¼-42½	Seat Width	20¼				

• Platinum Metallic option not available

**MID BACK
HEIGHT ADJUSTABLE
WOOD ARM
KNEE TILT
WOOD BASE**



Height Adjustable Wood Arm

		1	2/COM	3/COL	4	5	6	7	L7	L8
N14TR	Plastic Back	\$ 1030	1058	1071	1090	1112	1150	1199	1436	1511
N14TRS	Plastic Back/Seatslide	1124	1152	1165	1184	1206	1244	1293	1530	1605
N14KT	Upholstered Back	1058	1093	1109	1133	1160	1208	1270	1565	1660
N14KTS	Upholstered Back/Seatslide	1154	1189	1205	1229	1256	1304	1366	1661	1756

DIMENSIONS

Width		Seat Height	16¼-20¼	Arm Height		Weight	
Depth		Seat Height with		Back Height		Weight with	
Depth with		Seatslide	16¼-20¼	Back Width		Seatslide	
Seatslide		Seat Depth				Cubic Ft.	
Height		Seat Depth with					
Height with		Seatslide					
Seatslide		Seat Width					

• Platinum Metallic option not available

**MID BACK
HEIGHT, WIDTH
ADJUSTABLE WOOD ARM
KNEE TILT
WOOD BASE**



Height, Width Adjustable
Wood Arm

		1	2/COM	3/COL	4	5	6	7	L7	L8
N14JR	Plastic Back	\$ 1055	1083	1096	1115	1137	1175	1224	1461	1536
N14JRS	Plastic Back/Seatslide	1149	1177	1190	1209	1231	1269	1318	1555	1630
N14KR	Upholstered Back	1084	1119	1135	1159	1186	1234	1296	1591	1686
N14KRS	Upholstered Back/Seatslide	1180	1215	1231	1255	1282	1330	1392	1687	1782

DIMENSIONS

Width	26¼-29¼	Seat Height	16¼-20¼	Arm Height	25¼-32	Weight	63
Depth	26	Seat Height with		Back Height	19-21½	Weight with	
Depth with		Seatslide	16¼-20¼	Back Width	18	Seatslide	66
Seatslide	25¼-26¾	Seat Depth	16¾			Cubic Ft.	18.3
Height	32¼-42	Seat Depth with					
Height with		Seatslide	16¾-19¼				
Seatslide	32¼-42½	Seat Width	20¼				

• Platinum Metallic option not available

TO ORDER, SPECIFY:

1. Model Number
 2. Fabric Grade Number
 3. Cover Number
 4. Finish Designator
 5. Casters
- See page 291 for Mix-it options

**MID BACK
ARMLESS
SYNCHRONOUS
WOOD BASE**



MODEL NO.	GRADE / LIST PRICE										
		1	2/COM	3/COL	4	5	6	7	L7	L8	
N14AAC	Plastic Back	\$ 863	891	904	923	945	983	1032	1269	1344	
N14AACS	Plastic Back/Seatslide	961	989	1002	1021	1043	1081	1130	1367	1442	
N14BBC	Upholstered Back	896	931	947	971	998	1046	1108	1403	1498	
N14BBCS	Upholstered Back/Seatslide	989	1024	1040	1064	1091	1139	1201	1496	1591	

DIMENSIONS

Width	26¼	Seat Height	17½-22½	Back Height	19-21½	Weight	55.1
Depth	26¼	Seat Height with Seatslide	18-23	Back Width	18	Weight with Seatslide	58.7
Depth with Seatslide	25¼-26½	Seat Depth	16½			Cubic Ft.	18.3
Height	35¼-43¼	Seat Depth with Seatslide	16½-18¾				
Height with Seatslide	36½-44½	Seat Width	20¼				

• Platinum Metallic option not available

**MID BACK
STATIC WOOD ARM
SYNCHRONOUS
WOOD BASE**



MODEL NO.	GRADE / LIST PRICE										
		1	2/COM	3/COL	4	5	6	7	L7	L8	
N14CCC	Plastic Back	\$ 1113	1141	1154	1173	1195	1233	1282	1519	1594	
N14CCCS	Plastic Back/Seatslide	1211	1239	1252	1271	1293	1331	1380	1617	1692	
N14DDC	Upholstered Back	1145	1180	1196	1220	1247	1295	1357	1652	1747	
N14DDCS	Upholstered Back/Seatslide	1241	1276	1292	1316	1343	1391	1453	1748	1843	

DIMENSIONS

Width	26¼	Seat Height	17½-22½	Arm Height	26½-34½	Weight	63
Depth	26¼	Seat Height with Seatslide	18-23	Back Height	19-21½	Weight with Seatslide	66.6
Depth with Seatslide	25¼-26½	Seat Depth	16¼	Back Width	18	Cubic Ft.	18.3
Height	35¼-43¼	Seat Depth with Seatslide	16½-18¾				
Height with Seatslide	36½-44½	Seat Width	20¼				

• Platinum Metallic option not available



Static Wood Arm

**MID BACK
HEIGHT ADJUSTABLE
WOOD ARM
SYNCHRONOUS
WOOD BASE**



Height Adjustable Wood Arm

MODEL NO.		GRADE / LIST PRICE									
		1	2/COM	3/COL	4	5	6	7	L7	L8	
N14TJC	Plastic Back	\$ 1113	1141	1154	1173	1195	1233	1282	1519	1594	
N14TJCS	Plastic Back/Seatslide	1209	1237	1250	1269	1291	1329	1378	1615	1690	
N14KTC	Upholstered Back	1143	1178	1194	1218	1245	1293	1355	1650	1745	
N14KTCS	Upholstered Back/Seatslide	1236	1271	1287	1311	1338	1386	1448	1743	1838	

DIMENSIONS

Width	Seat Height	17½-22½	Arm Height	Weight
Depth	Seat Height with		Back Height	Weight with
Depth with	Seatslide	18-23	Back Width	Seatslide
Seatslide	Seat Depth			Cubic Ft.
Height	Seat Depth with			
Height with	Seatslide			
Seatslide	Seat Width			

• Platinum Metallic option not available

**MID BACK
HEIGHT, WIDTH
ADJUSTABLE WOOD ARM
SYNCHRONOUS
WOOD BASE**



Height, Width Adjustable Wood Arm

MODEL NO.		GRADE / LIST PRICE									
		1	2/COM	3/COL	4	5	6	7	L7	L8	
N14JJC	Plastic Back/Wood Base	\$ 1138	1166	1179	1198	1220	1258	1307	1544	1619	
N14JJCS	Plastic Back/Wood Base/Seatslide	1234	1262	1275	1294	1316	1354	1403	1640	1715	
N14KKC	Upholstered Back/Wood Base	1169	1204	1220	1244	1271	1319	1381	1676	1771	
N14KKCS	Upholstered Back/Wood Base/Seatslide	1261	1296	1312	1336	1363	1411	1473	1768	1863	

DIMENSIONS

Width	26¼-29¼	Seat Height	17½-22½	Arm Height	25½-33¼	Weight	60.9
Depth	26¾	Seat Height with		Back Height	19-21½	Weight with	
Depth with		Seatslide	18-23	Back Width	18	Seatslide	64.5
Seatslide	25¼-26½	Seat Depth	16¾			Cubic Ft.	18.3
Height	35¾-43¾	Seat Depth with					
Height with		Seatslide	16½-18¾				
Seatslide	36½-44½	Seat Width	20¼				

• Platinum Metallic option not available

**HIGH BACK
STATIC WOOD ARM
KNEE TILT
WOOD BASE**



Static Wood Arm

MODEL NO.		GRADE / LIST PRICE									
		1	2/COM	3/COL	4	5	6	7	L7	L8	
N14ER	Plastic Back	\$ 1062	1092	1106	1127	1150	1192	1245	1501	1583	
N14ERS	Plastic Back/Seatslide	1153	1183	1197	1218	1241	1283	1336	1592	1674	
N14HR	Upholstered Back	1090	1127	1144	1170	1199	1250	1316	1631	1732	
N14HRS	Upholstered Back/Seatslide	1186	1223	1240	1266	1295	1346	1412	1727	1828	

DIMENSIONS

Width	26¼	Seat Height	16¼-20¼	Arm Height	26½-30	Weight	67
Depth	26	Seat Height with		Back Height	22-24½	Weight with	
Depth with		Seatslide	16¾-20¾	Back Width	18½	Seatslide	70
Seatslide	25¼-26¾	Seat Depth	16¾			Cubic Ft.	19.1
Height	36¼-46	Seat Depth with					
Height with		Seatslide	16¾-19¼				
Seatslide	36¾-46½	Seat Width	20¼				

• Platinum Metallic option not available

TO ORDER, SPECIFY:

1. Model Number
 2. Fabric Grade Number
 3. Cover Number
 4. Finish Designator
 5. Casters
- See page 291 for Mix-it options

**HIGH BACK
HEIGHT ADJUSTABLE
WOOD ARM
KNEE TILT
WOOD BASE**



Height Adjustable Wood Arm

MODEL NO.	GRADE / LIST PRICE										
		1	2/COM	3/COL	4	5	6	7	L7	L8	
N14MT	Plastic Back	\$ 1056	1086	1100	1121	1144	1186	1239	1495	1577	
N14MTS	Plastic Back/Seatslide	1152	1182	1196	1217	1240	1282	1335	1591	1673	
N14PT	Upholstered Back	1089	1126	1143	1169	1198	1249	1315	1630	1731	
N14PTS	Upholstered Back/Seatslide	1185	1222	1239	1265	1294	1345	1411	1726	1827	

DIMENSIONS

Width	Seat Height	16¼-20¼	Arm Height	Weight
Depth	Seat Height with		Back Height	Weight with
Depth with	Seatslide	16¾-20¾	Back Width	Seatslide
Seatslide	Seat Depth			Cubic Ft.
Height	Seat Depth with			
Height with	Seatslide			
Seatslide	Seat Width			

• Platinum Metallic option not available

**HIGH BACK
HEIGHT, WIDTH
ADJUSTABLE WOOD ARM
KNEE TILT
WOOD BASE**



Height, Width Adjustable Wood Arm

MODEL NO.	GRADE / LIST PRICE										
		1	2/COM	3/COL	4	5	6	7	L7	L8	
N14MR	Plastic Back	\$ 1082	1112	1126	1147	1170	1212	1265	1521	1603	
N14MRS	Plastic Back/Seatslide	1178	1208	1222	1243	1266	1308	1361	1617	1699	
N14PR	Upholstered Back	1114	1151	1168	1194	1223	1274	1340	1655	1756	
N14PRS	Upholstered Back/Seatslide	1210	1247	1264	1290	1319	1370	1436	1751	1852	

DIMENSIONS

Width	26¼	Seat Height	16¼-20¼	Arm Height	25¼-32	Weight	67
Depth	26	Seat Height with		Back Height	22-24½	Weight with	
Depth with		Seatslide	17-20½	Back Width	18½	Seatslide	70
Seatslide	25¼-26¾	Seat Depth	16¾			Cubic Ft.	19.1
Height	36¼-46	Seat Depth with					
Height with		Seatslide	16¾-19¼				
Seatslide	36¾-46½	Seat Width	20¼				

• Platinum Metallic option not available

**HIGH BACK
STATIC WOOD ARM
SYNCHRONOUS
WOOD BASE**



Static Wood Arm

**MODEL
NO.**

GRADE / LIST PRICE

		1	2/COM	3/COL	4	5	6	7	L7	L8
N14EEC	Plastic Back	\$ 1143	1173	1187	1208	1231	1273	1326	1582	1664
N14EES	Plastic Back/Seatslide	1238	1268	1282	1303	1326	1368	1421	1677	1759
N14HHC	Upholstered Back	1173	1210	1227	1253	1282	1333	1399	1714	1815
N14HCS	Upholstered Back/Seatslide	1271	1308	1325	1351	1380	1431	1497	1812	1913

DIMENSIONS

Width	26¼	Seat Height	17½-22½	Arm Height	26½-34½	Weight	64
Depth	26¼	Seat Height with		Back Height	22-24½	Weight with	
Depth with		Seatslide	18-23	Back Width	18½	Seatslide	67.6
Seatslide	25¼-26½	Seat Depth	16¾			Cubic Ft.	19.1
Height	39½-47½	Seat Depth with					
Height with		Seatslide	16½-18¾				
Seatslide	40¼-48¼	Seat Width	20¼				

• Platinum Metallic option not available

**HIGH BACK
HEIGHT ADJUSTABLE
WOOD ARM
SYNCHRONOUS
WOOD BASE**



Height Adjustable Wood Arm

		1	2/COM	3/COL	4	5	6	7	L7	L8
N14TMC	Plastic Back	\$ 1141	1171	1185	1206	1229	1271	1324	1580	1662
N14TMS	Plastic Back/Seatslide	1234	1264	1278	1299	1322	1364	1417	1673	1755
N14TPC	Upholstered Back	1174	1211	1228	1254	1283	1334	1400	1715	1816
N14TPCS	Upholstered Back/Seatslide	1267	1304	1321	1347	1376	1427	1493	1808	1909

DIMENSIONS

Width		Seat Height	17½-22½	Arm Height		Weight	
Depth		Seat Height with		Back Height		Weight with	
Depth with		Seatslide	18-23	Back Width		Seatslide	
Seatslide		Seat Depth				Cubic Ft.	
Height		Seat Depth with					
Height with		Seatslide					
Seatslide		Seat Width					

• Platinum Metallic option not available

**HIGH BACK
HEIGHT, WIDTH
ADJUSTABLE WOOD ARM
SYNCHRONOUS
WOOD BASE**



Height, Width Adjustable
Wood Arm

		1	2/COM	3/COL	4	5	6	7	L7	L8
N14MMC	Plastic Back	\$ 1167	1197	1211	1232	1255	1297	1350	1606	1688
N14MMS	Plastic Back/Seatslide	1259	1289	1303	1324	1347	1389	1442	1698	1780
N14PPC	Upholstered Back	1199	1236	1253	1279	1308	1359	1425	1740	1841
N14PPCS	Upholstered Back/Seatslide	1292	1329	1346	1372	1401	1452	1518	1833	1934

DIMENSIONS

Width	26¼	Seat Height	17½-22½	Arm Height	25½-33¼	Weight	66.4
Depth	26¼	Seat Height with		Back Height	22-24½	Weight with	
Depth with		Seatslide	18-23	Back Width	18½	Seatslide	70.0
Seatslide	25¼-26½	Seat Depth	16¾			Cubic Ft.	19.1
Height	39½-47½	Seat Depth with					
Height with		Seatslide	16½-18¾				
Seatslide	40¼-48¼	Seat Width	20¼				

• Platinum Metallic option not available

To You In 10 DAYS ...or Less
 Shaded model numbers are available on our "To You in 10 Days or Less" Quick Delivery program and will be delivered within 10 days.

TO ORDER, SPECIFY:

1. Model Number
 2. Fabric Grade Number
 3. Cover Number
 4. Finish Designator
 5. Casters
- See page 291 for Mix-it options

GUEST WOOD ARMS

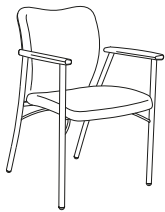

MODEL NO.

GRADE / LIST PRICE

Quick Delivery Model: QN14QQ

		1	2/COM	3/COL	4	5	6	7	L7	L8
N14RR	Plastic Back	\$ 668	693	705	723	743	778	823	1040	1109
N14QQ	Upholstered Back	699	731	747	769	794	839	896	1172	1260

DIMENSIONS

Width	24¾	Seat Height	18½	Arm Height	26¼	Weight	40
Depth	24	Seat Depth	18¼	Kneespace	20	Cubic Ft.	16.4
Height	35¼	Seat Width	20¾				

• Platinum Metallic option – specify P (i.e., N14RRP) available for a \$35 list upcharge

STOOL ARMLESS KNEE TILT PLASTIC BASE



		1	2/COM	3/COL	4	5	6	7	L7	L8
N12ARY	Plastic Back	\$ 822	850	863	882	904	942	991	1228	1303
N12BRY	Upholstered Back	850	885	901	925	952	1000	1062	1357	1452

DIMENSIONS

Width	26¼	Seat Height	22½-28¾	Back Height	19-21½	Weight	48
Depth	26	Seat Depth	16¾	Back Width	18	Cubic Ft.	20.4
Height	41-50	Seat Width	20¾				

• Platinum Metallic option – specify P (i.e., N12ARYP) available for a \$133 list upcharge

**STOOL
STATIC ARM
KNEE TILT
PLASTIC BASE**



Static Arm

**MODEL
NO.**

GRADE / LIST PRICE

		1	2/COM	3/COL	4	5	6	7	L7	L8
N12CRY	Plastic Back	\$ 978	1006	1019	1038	1060	1098	1147	1384	1459
N12DRY	Upholstered Back	1008	1043	1059	1083	1110	1158	1220	1515	1610

DIMENSIONS

Width	26¼	Seat Height	22½-28¼	Arm Height	32¼-39	Weight	54
Depth	26	Seat Depth	16¼	Back Height	19-21½	Cubic Ft.	20.4
Height	41-50	Seat Width	20¼	Back Width	18		

• Platinum Metallic option – specify P (i.e., N12CRYP) available for a \$133 list upcharge

**STOOL
HEIGHT ADJUSTABLE ARM
KNEE TILT
PLASTIC BASE**



Height Adjustable Arm

		1	2/COM	3/COL	4	5	6	7	L7	L8
N12JTY	Plastic Back	\$ 973	1001	1014	1033	1055	1093	1142	1379	1454
N12KTY	Upholstered Back	1002	1037	1053	1077	1104	1152	1214	1509	1604

DIMENSIONS

Width		Seat Height		Arm Height		Weight	
Depth		Seat Depth		Back Height		Cubic Ft.	
Height		Seat Width		Back Width			

• Platinum Metallic option – specify P (i.e., N12JTYP) available for a \$133 list upcharge

**STOOL
HEIGHT, WIDTH
ADJUSTABLE ARM
KNEE TILT
PLASTIC BASE**



Height, Width Adjustable Arm

		1	2/COM	3/COL	4	5	6	7	L7	L8
N12JRY	Plastic Back	\$ 998	1026	1039	1058	1080	1118	1167	1404	1479
N12KRY	Upholstered Back	1027	1062	1078	1102	1129	1177	1239	1534	1629

DIMENSIONS

Width	26¼-29¼	Seat Height	22½-28¼	Arm Height	31½-41	Weight	56
Depth	26	Seat Depth	16¼	Back Height	19-21½	Cubic Ft.	20.4
Height	41-50	Seat Width	20¼	Back Width	18		

• Platinum Metallic option – specify P (i.e., N12JRYYP) available for a \$133 list upcharge

TO ORDER, SPECIFY:

1. Model Number
 2. Fabric Grade Number
 3. Cover Number
 4. Finish Designator
 5. Casters
- See page 291 for Mix-it options

**STOOL
HIGH PERFORMANCE ARM
KNEE TILT
PLASTIC BASE**



High Performance Arm

MODEL NO.	GRADE / LIST PRICE										
		1	2/COM	3/COL	4	5	6	7	L7	L8	
N12JRYE	Plastic Back	\$ 1108	1136	1149	1168	1190	1228	1277	1514	1589	
N12KRYE	Upholstered Back	1137	1172	1188	1212	1239	1287	1349	1644	1739	

DIMENSIONS

Width	26¼-29¼	Seat Height	22½-28¾	Arm Height	31-41½	Weight	56
Depth	26	Seat Depth	16¾	Back Height	19-21½	Cubic Ft.	20.4
Height	41-50	Seat Width	20¼	Back Width	18		

- Platinum Metallic option – specify P (i.e., N12JRYEP) available for a \$133 list upcharge

**STOOL
STATIC WOOD ARM
KNEE TILT
PLASTIC BASE**



Static Wood Arm

MODEL NO.	GRADE / LIST PRICE										
		1	2/COM	3/COL	4	5	6	7	L7	L8	
N13CRY	Plastic Back	\$ 1072	1100	1113	1132	1154	1192	1241	1478	1553	
N13DRY	Upholstered Back	1103	1138	1154	1178	1205	1253	1315	1610	1705	

DIMENSIONS

Width	26¼	Seat Height	22½-28¾	Arm Height	32¾-39	Weight	55
Depth	26	Seat Depth	16¾	Back Height	19-21½	Cubic Ft.	20.4
Height	41-50	Seat Width	20¼	Back Width	18		

- Platinum Metallic option not available

**STOOL
HEIGHT ADJUSTABLE
WOOD ARM
KNEE TILT
PLASTIC BASE**



Height Adjustable Wood Arm

MODEL NO.

GRADE / LIST PRICE

		1	2/COM	3/COL	4	5	6	7	L7	L8
N13JTY	Plastic Back	\$ 1070	1098	1111	1130	1152	1190	1239	1476	1551
N13KTY	Upholstered Back	1100	1135	1151	1175	1202	1250	1312	1607	1702

DIMENSIONS

Width	Seat Height	Arm Height	Weight
Depth	Seat Depth	Back Height	Cubic Ft.
Height	Seat Width	Back Width	

- Platinum Metallic option not available

**STOOL
HEIGHT, WIDTH
ADJUSTABLE WOOD ARM
KNEE TILT
PLASTIC BASE**



Height, Width Adjustable Wood Arm

		1	2/COM	3/COL	4	5	6	7	L7	L8
N13JRY	Plastic Back	\$ 1095	1123	1136	1155	1177	1215	1264	1501	1576
N13KRY	Upholstered Back	1125	1160	1176	1200	1227	1275	1337	1632	1727

DIMENSIONS

Width	26¼-29¼	Seat Height	22½-28¼	Arm Height	31½-41	Weight	57
Depth	26	Seat Depth	16¾	Back Height	19-21½	Cubic Ft.	20.4
Height	41-50	Seat Width	20¼	Back Width	18		

- Platinum Metallic option not available

**STOOL
ARMLESS
SYNCHRONOUS
PLASTIC BASE**



		1	2/COM	3/COL	4	5	6	7	L7	L8
N12AAY	Plastic Back	\$ 905	933	946	965	987	1025	1074	1311	1386
N12BBY	Upholstered Back	932	967	983	1007	1034	1082	1144	1439	1534

DIMENSIONS

Width	26¼	Seat Height	21¾-28¾	Back Height	19-21½	Weight	45
Depth	26	Seat Depth	16¾	Back Width	18	Cubic Ft.	20.4
Height	39¾-50½	Seat Width	20¼				

- Platinum Metallic option – specify P (i.e., N12AAYP) available for a \$133 list upcharge

TO ORDER, SPECIFY:

1. Model Number
 2. Fabric Grade Number
 3. Cover Number
 4. Finish Designator
 5. Casters
- See page 291 for Mix-it options

**STOOL
STATIC ARM
SYNCHRONOUS
PLASTIC BASE**



MODEL NO.	GRADE / LIST PRICE										
		1	2/COM	3/COL	4	5	6	7	L7	L8	
N12CCY	Plastic Back	\$ 1062	1090	1103	1122	1144	1182	1231	1468	1543	
N12DDY	Upholstered Back	1093	1128	1144	1168	1195	1243	1305	1600	1695	

DIMENSIONS

Width	26¼	Seat Height	21¾-28¾	Arm Height	32-39	Weight	51
Depth	26	Seat Depth	16¾	Back Height	19-21½	Cubic Ft.	20.4
Height	39¾-50½	Seat Width	20¾	Back Width	18½		

- Platinum Metallic option – specify P (i.e., N12CCYP) available for a \$133 list upcharge



Static Arm

**STOOL
HEIGHT ADJUSTABLE ARM
SYNCHRONOUS
PLASTIC BASE**



MODEL NO.	GRADE / LIST PRICE										
		1	2/COM	3/COL	4	5	6	7	L7	L8	
N12TJY	Plastic Back	\$ 1054	1082	1095	1114	1136	1174	1223	1460	1535	
N12TKY	Upholstered Back	1084	1119	1135	1159	1186	1234	1296	1591	1686	

DIMENSIONS

Width		Seat Height		Arm Height		Weight	
Depth		Seat Depth		Back Height		Cubic Ft.	
Height		Seat Width		Back Width			

- Platinum Metallic option – specify P (i.e., N12TJYP) available for a \$133 list upcharge



Height Adjustable Arm

**STOOL
HEIGHT, WIDTH
ADJUSTABLE ARM
SYNCHRONOUS
PLASTIC BASE**



Height, Width Adjustable Arm

**MODEL
NO.**

GRADE / LIST PRICE

		1	2/COM	3/COL	4	5	6	7	L7	L8
N12JJY	Plastic Back	\$ 1080	1108	1121	1140	1162	1200	1249	1486	1561
N12KKY	Upholstered Back	1109	1144	1160	1184	1211	1259	1321	1616	1711

DIMENSIONS

Width	26¼-29¼	Seat Height	21¾-28¾	Arm Height	30¼-41	Weight	53
Depth	26	Seat Depth	16¾	Back Height	19-21½	Cubic Ft.	20.4
Height	39¾-50½	Seat Width	20¼	Back Width	18		

• Platinum Metallic option – specify P (i.e., N12JJYP) available for a \$133 list upcharge

**STOOL
HIGH PERFORMANCE ARM
SYNCHRONOUS
PLASTIC BASE**



High Performance Arm

		1	2/COM	3/COL	4	5	6	7	L7	L8
N12JJYE	Plastic Back	\$ 1190	1218	1231	1250	1272	1310	1359	1596	1671
N12KKYE	Upholstered Back	1219	1254	1270	1294	1321	1369	1431	1726	1821

DIMENSIONS

Width	26¼-29¼	Seat Height	21¾-28¾	Arm Height	30¼-41½	Weight	53
Depth	26	Seat Depth	16¾	Back Height	19-21½	Cubic Ft.	20.4
Height	39¾-50½	Seat Width	20¼	Back Width	18		

• Platinum Metallic option – specify P (i.e., N12JJYEP) available for a \$133 list upcharge

**STOOL
STATIC WOOD ARM
SYNCHRONOUS
PLASTIC BASE**



Static Wood Arm

		1	2/COM	3/COL	4	5	6	7	L7	L8
N13CCY	Plastic Back	\$ 1153	1181	1194	1213	1235	1273	1322	1559	1634
N13DDY	Upholstered Back	1185	1220	1236	1260	1287	1335	1397	1692	1787

DIMENSIONS

Width	26¼	Seat Height	21¾-28¾	Arm Height	32-39	Weight	52
Depth	26	Seat Depth	16¾	Back Height	19-21½	Cubic Ft.	20.4
Height	39¾-50½	Seat Width	20¼	Back Width	18		

• Platinum Metallic option – specify P (i.e., N13CCYP) available for a \$133 list upcharge

TO ORDER, SPECIFY:

1. Model Number
 2. Fabric Grade Number
 3. Cover Number
 4. Finish Designator
 5. Casters
- See page 291 for Mix-it options

**STOOL
HEIGHT ADJUSTABLE
WOOD ARM
SYNCHRONOUS
PLASTIC BASE**



Height Adjustable Wood Arm

MODEL NO.	GRADE / LIST PRICE										
		1	2/COM	3/COL	4	5	6	7	L7	L8	
N13TJY	Plastic Back	\$ 1151	1179	1192	1211	1233	1271	1320	1557	1632	
N13TKY	Upholstered Back	1183	1218	1234	1258	1285	1333	1395	1690	1785	

DIMENSIONS

Width	Seat Height	Arm Height	Weight
Depth	Seat Depth	Back Height	Cubic Ft.
Height	Seat Width	Back Width	

• Platinum Metallic option not available

**STOOL
HEIGHT, WIDTH
ADJUSTABLE WOOD ARM
SYNCHRONOUS
PLASTIC BASE**



Height, Width Adjustable Wood Arm

MODEL NO.	GRADE / LIST PRICE										
		1	2/COM	3/COL	4	5	6	7	L7	L8	
N13JJY	Plastic Back	\$ 1177	1205	1218	1237	1259	1297	1346	1583	1658	
N13KKY	Upholstered Back	1208	1243	1259	1283	1310	1358	1420	1715	1810	

DIMENSIONS

Width	26¼-29¼	Seat Height	21¼-28½	Arm Height	30¼-41	Weight	54
Depth	26	Seat Depth	16¾	Back Height	19-21½	Cubic Ft.	20.4
Height	39¼-50½	Seat Width	20¼	Back Width	18		

• Platinum Metallic option not available

**STOOL
ARMLESS
KNEE TILT
WOOD BASE**



MODEL NO.

GRADE / LIST PRICE

		1	2/COM	3/COL	4	5	6	7	L7	L8
N14ARY	Plastic Back	\$ 902	930	943	962	984	1022	1071	1308	1383
N14BRY	Upholstered Back	934	969	985	1009	1036	1084	1146	1441	1536

DIMENSIONS

Width	26¼	Seat Height	22¾-29	Back Height	19-21½	Weight	48
Depth	26¼	Seat Depth	16¼	Back Width	18	Cubic Ft.	20.4
Height	41¼-50¼	Seat Width	20¼				

• Platinum Metallic option not available

**STOOL
STATIC WOOD ARM
KNEE TILT
WOOD BASE**



		1	2/COM	3/COL	4	5	6	7	L7	L8
N14CRY	Plastic Back	\$ 1151	1179	1192	1211	1233	1271	1320	1557	1632
N14DRY	Upholstered Back	1184	1219	1235	1259	1286	1334	1396	1691	1786

DIMENSIONS

Width	26¼	Seat Height	22¾-29	Arm Height	33-39¼	Weight	62
Depth	26	Seat Depth	16¼	Back Height	19-21½	Cubic Ft.	20.4
Height	41¼-50¼	Seat Width	20¼	Back Width	18		

• Platinum Metallic option not available



Static Wood Arm

**STOOL
HEIGHT ADJUSTABLE
WOOD ARM
KNEE TILT
WOOD BASE**



		1	2/COM	3/COL	4	5	6	7	L7	L8
N14JTY	Plastic Back	\$ 1151	1179	1192	1211	1233	1271	1320	1557	1632
N14KTY	Upholstered Back	1182	1217	1233	1257	1284	1332	1394	1689	1784

DIMENSIONS

Width		Seat Height		Arm Height		Weight	
Depth		Seat Depth		Back Height		Cubic Ft.	
Height		Seat Width		Back Width			

• Platinum Metallic option not available



Height Adjustable Wood Arm

TO ORDER, SPECIFY:

1. Model Number
 2. Fabric Grade Number
 3. Cover Number
 4. Finish Designator
 5. Casters
- See page 291 for Mix-it options

**STOOL
HEIGHT, WIDTH
ADJUSTABLE WOOD ARM
KNEE TILT
WOOD BASE**



Height, Width Adjustable
Wood Arm

MODEL NO.	GRADE / LIST PRICE										
		1	2/COM	3/COL	4	5	6	7	L7	L8	
N14JRY	Plastic Back	\$ 1177	1205	1218	1237	1259	1297	1346	1583	1658	
N14KRY	Upholstered Back	1207	1242	1258	1282	1309	1357	1419	1714	1809	

DIMENSIONS

Width	26¼-29¼	Seat Height	22¼-29	Arm Height	31¼-39¼	Weight	64
Depth	26	Seat Depth	16¼	Back Height	19-21½	Cubic Ft.	20.4
Height	41¼-50¼	Seat Width	20¼	Back Width	18		

- Platinum Metallic option not available

**STOOL
ARMLESS
SYNCHRONOUS
WOOD BASE**



MODEL NO.	GRADE / LIST PRICE										
		1	2/COM	3/COL	4	5	6	7	L7	L8	
N14AAY	Plastic Back	\$ 985	1013	1026	1045	1067	1105	1154	1391	1466	
N14BBY	Upholstered Back	1018	1053	1069	1093	1120	1168	1230	1525	1620	

DIMENSIONS

Width	26¼	Seat Height	22¼-29	Back Height	19-21½	Weight	52
Depth	26¼	Seat Depth	16¼	Back Width	18	Cubic Ft.	20.4
Height	40-50¼	Seat Width	20¼				

- Platinum Metallic option not available

**STOOL
STATIC WOOD ARM
SYNCHRONOUS
WOOD BASE**



Static Wood Arm

**MODEL
NO.**

GRADE / LIST PRICE

		1	2/COM	3/COL	4	5	6	7	L7	L8
N14CCY	Plastic Back	\$ 1236	1264	1277	1296	1318	1356	1405	1642	1717
N14DDY	Upholstered Back	1267	1302	1318	1342	1369	1417	1479	1774	1869

DIMENSIONS

Width	26¼	Seat Height	22¼-29	Arm Height	32¼-39¼	Weight	59
Depth	26¼	Seat Depth	16¼	Back Height	19-21½	Cubic Ft.	20.4
Height	40-50¼	Seat Width	20¼	Back Width	18		

• Platinum Metallic option not available

**STOOL
HEIGHT ADJUSTABLE
WOOD ARM
SYNCHRONOUS
WOOD BASE**



Height Adjustable Wood Arm

		1	2/COM	3/COL	4	5	6	7	L7	L8
N14TJY	Plastic Back	\$ 1233	1261	1274	1293	1315	1353	1402	1639	1714
N14TKY	Upholstered Back	1264	1299	1315	1339	1366	1414	1476	1771	1866

DIMENSIONS

Width		Seat Height		Arm Height		Weight	
Depth		Seat Depth		Back Height		Cubic Ft.	
Height		Seat Width		Back Width			

**STOOL
HEIGHT, WIDTH
ADJUSTABLE WOOD ARM
SYNCHRONOUS
WOOD BASE**



Height, Width Adjustable
Wood Arm

		1	2/COM	3/COL	4	5	6	7	L7	L8
N14JJY	Plastic Back	\$ 1258	1286	1299	1318	1340	1378	1427	1664	1739
N14KKY	Upholstered Back	1289	1324	1340	1364	1391	1439	1501	1796	1891

DIMENSIONS

Width	26¼-29¼	Seat Height	23¼-29	Arm Height	31¼-41¼	Weight	61
Depth	26	Seat Depth	16¼	Back Height	19-21½	Cubic Ft.	20.4
Height	40-50¼	Seat Width	20¼	Back Width	18		

• Platinum Metallic option not available

Monterrey™

Monterrey

MONTERREY PRODUCT SPECIFICATIONS

FRAME CONSTRUCTION

- Interior frame is constructed of plywood with tenon joints that are glued and screwed for maximum joint stability
- Seat joints are supported by corner blocks
- Non-marring nylon glides

SEAT CONSTRUCTION

- Seat cushion is removable and features 5" of high grade polyurethane foam, which is custom shaped and fabricated and placed on high tension strip webbing
- Seat cushion is secured with fastener clips on 2 and 3 seat lounge models

BACK CONSTRUCTION

- 2½" of high grade polyurethane foam, which is custom shaped and stretched over web sheet and attached to frame

ARM CONSTRUCTION

- Armrest frames are wrapped with 1" of high grade polyurethane foam

UPHOLSTERY DETAIL

- Available with contrasting fabric or contrasting piping
- Welt cord framing referred to as piping

FINISH

- A catalyzed top coat resists denting, peeling, and reactions to chemicals
- Can be cleaned with a damp cloth
- Features our silver ion antimicrobial finish which inhibits the growth of bacteria and microbes

WOOD SPECIES

- Exposed wood base is constructed from soft maple

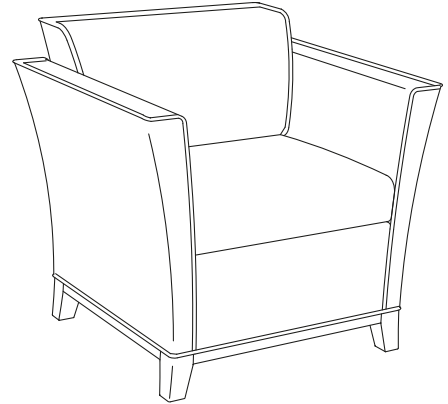

For comprehensive sustainability information that includes LEED® point contribution, visit NationalOfficeFurniture.ecoScorecard.com.

All Monterrey models may be ordered to meet TB133 fire code.

To order seating to meet the TB133 fire code, specify an "F" at the end of the model number (Ex: N90AAF).

Reference pages 465-493 for TB133 Fabric Matrix and pricing.

Please consult customer service for applicable Arc-Com, COM, Maharam, Momentum, Stinson or Ultrafabrics fabric.

FABRICS

- Grade 1 American Graffiti
- Cali
- Plush
- Ridge
- Speedway
- Stardust
- Grade 2 Cathedral
- COM
- Orbit
- Pixie
- Sedona
- Shenanigans
- Spectrum
- Strand
- Tranquility
- Twilight

- Grade 3 Boardwalk
- COL
- Jacks
- Pop Rocks
- Grade 4 Big City
- Bumble
- Connect Four
- Echo
- Silvertex
- Grade 6 Essence/Ultraleather
- Flock
- Scribe

- Grade 7 Brisa
- Brisa Distressed
- Promessa
- Silica
- Grade L7 Davenport
- Grade L8 Showcase

FINISHES

- | | |
|-------------|--------------------|
| IM Brighton | CW Cordovan |
| NM Natural | DW Judicial |
| HN Honey | MH Mocha |
| CL Caramel | 405 Designer White |
| TF Truffle | 462 Cinder |
| AC Autumn | 792 Sable |
| MC Amber | 793 Acorn |

Monterrey

To Order, Specify:

1. Model Number
2. Fabric Grade Number
3. Cover Number
4. Finish Designator

• See page 311 for Monterrey options

One Seat Lounge



Model No.	Grade / List Price							
	1	2/COM	3/COL	4	6	7	L7	L8
N90AA	\$ 1922	2032	2085	2162	2402	2599	3544	3847
Dimensions								
Width	34½	Seat Width	22	Arm Height	27¾	Weight	90	
Depth	30¼	Seat Depth	21			Cubic Ft.	27.0	
Height	31¾	Seat Height	19½					

Two Seat Lounge



Model No.	Grade / List Price							
	1	2/COM	3/COL	4	6	7	L7	L8
N90BB	\$ 2431	2622	2713	2846	3261	3601	5236	5759
Dimensions								
Width	63½	Seat Width	51	Arm Height	27¾	Weight	135	
Depth	30¼	Seat Depth	21			Cubic Ft.	51.0	
Height	31¾	Seat Height	19½					

- Cushion is one piece with stitching

Three Seat Lounge

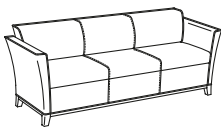

Model No.	Grade / List Price							
	1	2/COM	3/COL	4	6	7	L7	L8
N90CC	\$ 2997	3206	3306	3452	3907	4280	6073	6646
Dimensions								
Width	85½	Seat Width	73	Arm Height	27¾	Weight	165	
Depth	30¼	Seat Depth	21			Cubic Ft.	66.0	
Height	31¾	Seat Height	19½					

- Cushion is one piece with stitching

To Order, Specify:

1. Model Number
2. Seat/Back Grade Number
3. Seat/Back Cover Number
4. Outer Shell Grade Number
5. Outer Shell Cover Number
6. Finish Designator

**One Seat Lounge
Contrasting Fabric**

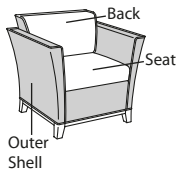

**Model
No.**

Grade / List Price

		Outer Shell Grade 1	Outer Shell Grade 2	Outer Shell Grade 3	Outer Shell Grade 4	Outer Shell Grade 6	Outer Shell Grade 7	Outer Shell Grade L7	Outer Shell Grade L8
N90AAX	Seat/Back Grade 1	\$ 1968	2060	2104	2168	2368	2532	3320	3572
	Seat/Back Grade 2	2000	2092	2136	2200	2400	2564	3352	3604
	Seat/Back Grade 3	2016	2108	2152	2216	2416	2580	3368	3620
	Seat/Back Grade 4	2038	2130	2174	2238	2438	2602	3390	3642
	Seat/Back Grade 6	2108	2200	2244	2308	2508	2672	3460	3712
	Seat/Back Grade 7	2165	2257	2301	2365	2565	2729	3517	3769
	Seat/Back Grade L7	2441	2533	2577	2641	2841	3005	3793	4045
	Seat/Back Grade L8	2529	2621	2665	2729	2929	3093	3881	4133

Dimensions

Width	34½	Seat Width	22	Arm Height	27¾	Weight	90
Depth	30¼	Seat Depth	21			Cubic Ft.	27.0
Height	31¾	Seat Height	19½				

- When specifying an Alliance Program fabric on seating models with contrasting fabric options, use your electronic specification tool or contact customer service for pricing

**Two Seat Lounge
Contrasting Fabric**

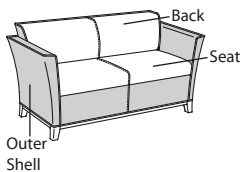

		Outer Shell Grade 1	Outer Shell Grade 2	Outer Shell Grade 3	Outer Shell Grade 4	Outer Shell Grade 6	Outer Shell Grade 7	Outer Shell Grade L7	Outer Shell Grade L8
N90BBX	Seat/Back Grade 1	\$ 2477	2599	2657	2742	3007	3224	4268	4602
	Seat/Back Grade 2	2553	2675	2733	2818	3083	3300	4344	4678
	Seat/Back Grade 3	2589	2711	2769	2854	3119	3336	4380	4714
	Seat/Back Grade 4	2642	2764	2822	2907	3172	3389	4433	4767
	Seat/Back Grade 6	2807	2929	2987	3072	3337	3554	4598	4932
	Seat/Back Grade 7	2942	3064	3122	3207	3472	3689	4733	5067
	Seat/Back Grade L7	3592	3714	3772	3857	4122	4339	5383	5717
	Seat/Back Grade L8	3800	3922	3980	4065	4330	4547	5591	5925

Dimensions

Width	63½	Seat Width	51	Arm Height	27¾	Weight	135
Depth	30¼	Seat Depth	21			Cubic Ft.	51.0
Height	31¾	Seat Height	19½				

- When specifying an Alliance Program fabric on seating models with contrasting fabric options, use your electronic specification tool or contact customer service for pricing
- Cushion is one piece with stitching

To Order, Specify:

1. Model Number
2. Seat/Back Grade Number
3. Seat/Back Cover Number
4. Outer Shell Grade Number
5. Outer Shell Cover Number
6. Finish Designator

• See page 311 for Monterrey options

**Three Seat Lounge
Contrasting Fabric**

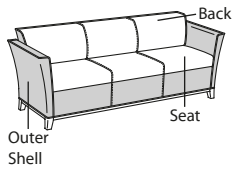

**Model
No.**

Grade / List Price

		Outer Shell Grade 1	Outer Shell Grade 2	Outer Shell Grade 3	Outer Shell Grade 4	Outer Shell Grade 6	Outer Shell Grade 7	Outer Shell Grade L7	Outer Shell Grade L8
N90CCX	Seat/Back Grade 1	\$ 3043	3183	3250	3348	3653	3903	5105	5489
	Seat/Back Grade 2	3156	3296	3363	3461	3766	4016	5218	5602
	Seat/Back Grade 3	3210	3350	3417	3515	3820	4070	5272	5656
	Seat/Back Grade 4	3288	3428	3495	3593	3898	4148	5350	5734
	Seat/Back Grade 6	3533	3673	3740	3838	4143	4393	5595	5979
	Seat/Back Grade 7	3734	3874	3941	4039	4344	4594	5796	6180
	Seat/Back Grade L7	4699	4839	4906	5004	5309	5559	6761	7145
	Seat/Back Grade L8	5008	5148	5215	5313	5618	5868	7070	7454

Dimensions

Width	85½	Seat Width	73	Arm Height	27¾	Weight	165
Depth	30¼	Seat Depth	21			Cubic Ft.	66.0
Height	31¾	Seat Height	19½				

- When specifying an Alliance Program fabric on seating models with contrasting fabric options, use your electronic specification tool or contact customer service for pricing
- Cushion is one piece with stitching

To Order, Specify:

1. Model Number
2. Fabric Grade Number
3. Fabric Cover Number
4. Piping Grade Number
5. Piping Cover Number
6. Finish Designator

**One Seat Lounge
Contrasting Piping**



Model No.	Grade / List Price	Piping	Piping	Piping	Piping	Piping	Piping	Piping	
		Grade 1	Grade 2	Grade 3	Grade 4	Grade 6	Grade 7	Grade L7	Grade L8
N90AAP	Fabric Grade 1	\$ 1948	1960	1965	1973	1998	2019	2117	2149
	Fabric Grade 2	2058	2070	2075	2083	2108	2129	2227	2259
	Fabric Grade 3	2111	2123	2128	2136	2161	2182	2280	2312
	Fabric Grade 4	2188	2200	2205	2213	2238	2259	2357	2389
	Fabric Grade 6	2428	2440	2445	2453	2478	2499	2597	2629
	Fabric Grade 7	2625	2637	2642	2650	2675	2696	2794	2826
	Fabric Grade L7	3570	3582	3587	3595	3620	3641	3739	3771
	Fabric Grade L8	3873	3885	3890	3898	3923	3944	4042	4074

Dimensions

Width	34½	Seat Width	22	Arm Height	27¾	Weight	90
Depth	30¾	Seat Depth	21			Cubic Ft.	27.0
Height	31¾	Seat Height	19½				

- Contrasting piping only available in National fabrics and leather

**Two Seat Lounge
Contrasting Piping**



Model No.	Grade / List Price	Piping	Piping	Piping	Piping	Piping	Piping	Piping	
		Grade 1	Grade 2	Grade 3	Grade 4	Grade 6	Grade 7	Grade L7	Grade L8
N90BBP	Fabric Grade 1	\$ 2454	2468	2474	2484	2514	2539	2657	2695
	Fabric Grade 2	2645	2659	2665	2675	2705	2730	2848	2886
	Fabric Grade 3	2736	2750	2756	2766	2796	2821	2939	2977
	Fabric Grade 4	2869	2883	2889	2899	2929	2954	3072	3110
	Fabric Grade 6	3284	3298	3304	3314	3344	3369	3487	3525
	Fabric Grade 7	3624	3638	3644	3654	3684	3709	3827	3865
	Fabric Grade L7	5259	5273	5279	5289	5319	5344	5462	5500
	Fabric Grade L8	5782	5796	5802	5812	5842	5867	5985	6023

Dimensions

Width	63½	Seat Width	51	Arm Height	27¾	Weight	135
Depth	30¾	Seat Depth	21			Cubic Ft.	51.0
Height	31¾	Seat Height	19½				

- Contrasting piping only available in National fabrics and leather
- Cushion is one piece with stitching

To Order, Specify:

1. Model Number
2. Fabric Grade Number
3. Fabric Cover Number
4. Piping Grade Number
5. Piping Cover Number
6. Finish Designator

• See page 311 for Monterrey options

Three Seat Lounge Contrasting Piping

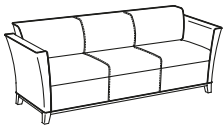

Model No.	Fabric Grade	Grade / List Price							
		Piping Grade 1	Piping Grade 2	Piping Grade 3	Piping Grade 4	Piping Grade 6	Piping Grade 7	Piping Grade L7	Piping Grade L8
N90CCP	Fabric Grade 1	\$ 3024	3040	3048	3059	3094	3123	3261	3305
	Fabric Grade 2	3233	3249	3257	3268	3303	3332	3470	3514
	Fabric Grade 3	3333	3349	3357	3368	3403	3432	3570	3614
	Fabric Grade 4	3479	3495	3503	3514	3549	3578	3716	3760
	Fabric Grade 6	3934	3950	3958	3969	4004	4033	4171	4215
	Fabric Grade 7	4307	4323	4331	4342	4377	4406	4544	4588
	Fabric Grade L7	6100	6116	6124	6135	6170	6199	6337	6381
	Fabric Grade L8	6673	6689	6697	6708	6743	6772	6910	6954

Dimensions

Width	85½	Seat Width	73	Arm Height	27¾	Weight	165
Depth	30¾	Seat Depth	21			Cubic Ft.	66.0
Height	31¾	Seat Height	19½				

- Contrasting piping only available in National fabrics and leather
- Cushion is one piece with stitching

Personal Pull-up Table



10N1622RTPUW	Wood	\$ 955
10N1622RTPUL	Laminate	955

Dimensions

Width	22	Weight	32
Depth	13¾	Cubic Ft.	9.25
Height	28½		

- 50 lb. weight limit
- Specify metal finish (462) Cinder, (501) Platinum Metallic, or (503) Satin Nickel Metallic
- Specify laminate or wood finish; **Laminates** (NM) Natural, (HN2) Honey 2, (CL) Caramel, (TF) Truffle, (AC2) Autumn 2, (MC) Amber, (CW) Cordovan, (DW) Judicial, (MH) Mocha, (405) Designer White, (462) Cinder, (791) Palisander, (792) Sable, or (793) Acorn; **Wood Finishes** (NM) Natural, (HN) Honey, (CL) Caramel, (TF) Truffle, (AC) Autumn, (MC) Amber, (CW) Cordovan, (DW) Judicial, (MH) Mocha, (405) Designer White, (462) Cinder, (792) Sable, or (793) Acorn

Pennant™

Pennant

PENNANT PRODUCT SPECIFICATIONS

62 Series

Pennant Lounge

FRAME CONSTRUCTION

- Interior frame is constructed of plywood, with joints double doweled and securely glued for maximum joint stability
- Seat joints are supported by corner blocks with high tensile screws
- Non-marring nylon glides

SEAT CONSTRUCTION

- Seat cushions are loose and feature 6" of high grade polyurethane foam, which is custom shaped and fabricated
- Brown denim and a ¼" felt insulator pad cover high tension strip webbing for comfort

BACK CONSTRUCTION

- 6½" of high grade polyurethane foam, which is custom shaped and fabricated, covers a ¾" interior plywood panel
- Panel is fastened to the interior back frame with screws

ARM CONSTRUCTION

- Armrest frames are wrapped with ¾" high grade polyurethane foam and slipcovered
- The frame is attached to the unit with three carriage bolts per arm

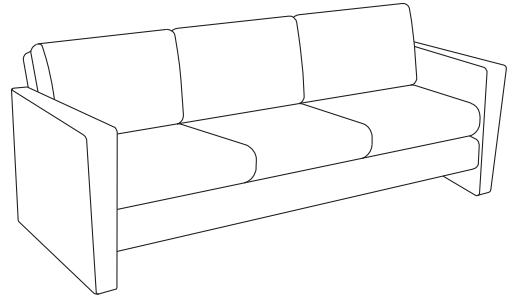

Pennant Guest

FRAME CONSTRUCTION

- Interior frame constructed of kiln-dried hardwoods with joints double doweled and securely glued for maximum joint stability
- Tie screws are installed at all critical joints for added strength
- Models have seat joints supported with additional corner blocks and secured with high tensile screws
- Non-marring nylon glides

SEAT CONSTRUCTION

- 2½" of high grade polyurethane foam covers high tension strip webbing for comfort

BACK CONSTRUCTION

- The back suspension features flexible sheet webbing stretched side-to-side and top-to-bottom, covered with 2" of high grade polyurethane foam

FINISH

- A catalyzed top coat resists denting, peeling and reactions to chemicals
- Can be cleaned with a damp cloth
- Features our silver ion antimicrobial finish which inhibits the growth of bacteria and microbes

WOOD SPECIES

- Hard maple

All Pennant models may be ordered to meet TB133 fire code.

To order seating to meet the TB133 fire code, specify an "F" at the end of the model number (Ex: 62X-UUXXF).

Reference pages 465-493 for TB133 Fabric Matrix and pricing.

Please consult customer service for applicable Arc-Com, COM, Maharam, Momentum, Stinson or Ultrafabrics fabric.



FABRICS

- Grade 1 American Graffiti
- Cali
- Plush
- Ridge
- Speedway
- Stardust
- Grade 2 Cathedral
- COM
- Orbit
- Pixie
- Sedona
- Shenanigans
- Spectrum
- Strand
- Tranquility
- Twilight

- Grade 3 Boardwalk
- COL
- Jacks
- Pop Rocks
- Grade 4 Big City
- Bumble
- Connect Four
- Echo
- Silvertex
- Grade 6 Essence/Ultraleather
- Flock
- Scribe

- Grade 7 Brisa
- Brisa Distressed
- Promessa
- Silica
- Grade L7 Davenport
- Grade L8 Showcase

FINISHES

- | | |
|-------------|--------------------|
| IM Brighton | CW Cordovan |
| NM Natural | DW Judicial |
| HN Honey | MH Mocha |
| CL Caramel | 405 Designer White |
| TF Truffle | 462 Cinder |
| AC Autumn | 792 Sable |
| MC Amber | 793 Acorn |

Pennant

To Order, Specify:

1. Model Number
2. Fabric Grade Number
3. Cover Number
4. Finish Designator (Guest only)

• See page 319 for Pennant options

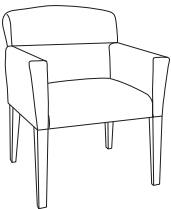
Guest	Model No.	Grade / List Price							
		1	2/COM	3/COL	4	6	7	L7	L8
	62X-GUXX	\$ 759	808	832	867	974	1062	1486	1621
	Dimensions								
	Width	27½	Arm Height	25½	Seat Depth	18¼	Weight	29	
	Depth	25½	Seat Height	17½	Seat Width	19½	Cubic Ft.	16.9	
	Height	33¼		Kneespace	19½				

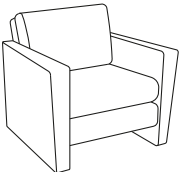
One Seat Lounge	Model No.	Grade / List Price							
		1	2/COM	3/COL	4	6	7	L7	L8
	62X-UUXX	\$ 1239	1354	1409	1489	1739	1944	2929	3244
	Dimensions								
	Width	32½	Arm Height	23¾	Seat Width	24	Weight	65	
	Depth	30¾	Seat Height	18¼			Cubic Ft.	30.2	
	Height	30½	Seat Depth	20					

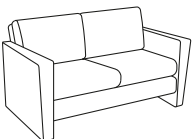
Two Seat Lounge	Model No.	Grade / List Price							
		1	2/COM	3/COL	4	6	7	L7	L8
	62X-LUXX	\$ 1601	1753	1825	1931	2261	2532	3832	4248
	Dimensions								
	Width	56½	Arm Height	23¾	Seat Width	48	Weight	107	
	Depth	30¾	Seat Height	18¼			Cubic Ft.	49.1	
	Height	30½	Seat Depth	20					

Three Seat Lounge

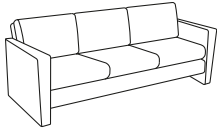

Model No.

Grade / List Price

	1	2/COM	3/COL	4	6	7	L7	L8
62X-AUXX	\$ 1997	2204	2303	2447	2897	3266	5039	5606

Dimensions

Width	80½	Arm Height	23¾	Seat Width	72	Weight	136
Depth	30¾	Seat Height	18¼			Cubic Ft.	66.9
Height	30½	Seat Depth	20				

Personal Pull-up Table



10N1622RTPUW	Wood	\$ 955
10N1622RTPUL	Laminate	955

Dimensions

Width	22	Weight	32
Depth	13¾	Cubic Ft.	9.25
Height	28½		

- 50 lb. weight limit
- Specify metal finish (462) Cinder, (501) Platinum Metallic, or (503) Satin Nickel Metallic
- Specify laminate or wood finish; **Laminates** (NM) Natural, (HN2) Honey 2, (CL) Caramel, (TF) Truffle, (AC2) Autumn 2, (MC) Amber, (CW) Cordovan, (DW) Judicial, (MH) Mocha, (405) Designer White, (462) Cinder, (791) Palisander, (792) Sable, or (793) Acorn; **Wood Finishes** (NM) Natural, (HN) Honey, (CL) Caramel, (TF) Truffle, (AC) Autumn, (MC) Amber, (CW) Cordovan, (DW) Judicial, (MH) Mocha, (405) Designer White, (462) Cinder, (792) Sable, or (793) Acorn

Remedy[®]

Remedy

REMEDY PRODUCT SPECIFICATIONS

79 Series

SEAT AND BACK CONSTRUCTION

- 7-ply inner, one piece solid molded plywood shell forms the seat and back
- 3" of high density foam covers the seat and 2" of high density foam covers the back

FRAME CONSTRUCTION (N79CC)

- All joints are double doweled and securely glued for maximum joint stability
- Frame is made of 1½" thick, 18-ply linear laminated veneers for structural integrity
- Non-marring nylon glides

ARMS

- Arms are molded of linear laminated beech veneers and are attached to the seat and back with metal L-brackets, threaded metal inserts (T-nuts) and machine screws
- Arms on the N79AAC and N79BBC have a protective upholstered arm cap that consists of ½" high grade polyurethane foam
- Arms available with contrasting fabric arm caps

CONTROL MECHANISM/LIFT

- The standard knee tilt mechanism features a heavy-duty adjustable tension spring for a variety of body sizes and minimal rise of front seat edge. This allows user's feet to remain planted when chair is in reclining position.
- The combination gas lift/tilt lock lever allows dual function with simple in/out movement for lockout and up/down movement for height adjustment

BASE AND CASTERS

- Wood base features a standard five-prong, rigid steel understructure to ensure a long life
- Caster posts fit directly into steel sleeves, greatly reducing caster socket failure
- Decorative hardwood caps complement the chair design
- Black, hard double wheel casters, which work on multiple surfaces, are standard
- Black, soft double wheel casters are available for use on hard floors; upcharge applies to this option
- All National bases are tested to BIFMA standards using 2500 lb. force

JURY BASE

- Pneumatic jury base
- Memory return swivel



FINISH

- Features a catalyzed top coat that resists denting, peeling and reactions to chemicals
- Can be cleaned with a damp cloth
- When specifying Brighton and Natural finish, variation in color is acceptable due to the nature of beech wood characteristics
- Features our silver ion antimicrobial finish which inhibits the growth of bacteria and microbes

WOOD SPECIES

- Beech

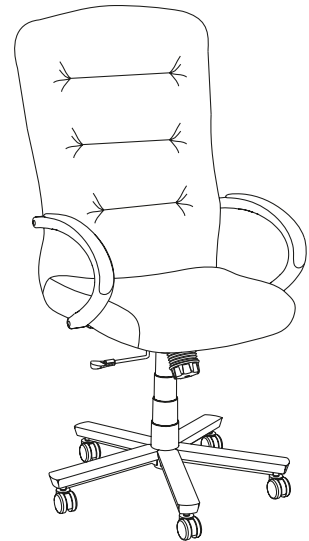

All Remedy models may be ordered to meet TB133 fire code.

To order seating to meet the TB133 fire code, specify an "F" at the end of the model number (Ex: N79AACF).

Reference pages 465-493 for TB133 Fabric Matrix and pricing.

Please consult customer service for applicable Arc-Com, COM, Maharam, Momentum, Stinson or Ultrafabrics fabric.



For comprehensive sustainability information that includes LEED® point contribution, visit NationalOfficeFurniture.ecoScorecard.com.

FABRICS

- Grade 1 American Graffiti
- Cali
- Plush
- Ridge
- Speedway
- Stardust

- Grade 2 Cathedral
- COM
- Orbit
- Pixie
- Sedona
- Shenanigans
- Spectrum
- Strand
- Tranquility
- Twilight

- Grade 3 Boardwalk
- COL
- Jacks
- Pop Rocks

- Grade 4 Big City
- Bumble
- Connect Four
- Echo
- Silvertex

- Grade 6 Essence/Ultraleather
- Flock
- Scribe

- Grade 7 Brisa
- Brisa Distressed
- Promessa
- Silica

- Grade L7 Davenport
- Grade L8 Showcase

FINISHES

- IM Brighton
- NM Natural
- HN Honey
- CL Caramel
- TF Truffle
- AC Autumn
- MC Amber
- CW Cordovan
- DW Judicial
- MH Mocha
- 405 Designer White
- 462 Cinder
- 792 Sable
- 793 Acorn

CASTERS

- C3 Hard (standard)
- C4 Soft (add \$24 list)

To You In
10 DAYS
...or Less

Shaded model numbers are available on our "To You in 10 Days or Less" Quick Delivery program and will be delivered within 10 days.

To Order, Specify:

1. Model Number
2. Fabric Grade Number
3. Cover Number
4. Finish Designator
5. Casters (when applicable)

• See page 325 for Remedy options

High Back with Upholstered Arm Caps



Model No.

Grade / List Price

Quick Delivery Model: QN79AAC

		1	2/COM	3/COL	4	6	7	L7	L8
N79AAC		\$ 896	940	961	991	1086	1164	1538	1658
N79AACJ	Jury Base	1121	1165	1186	1216	1311	1389	1763	1883

Dimensions

Width	26½	Seat Height	17¼-21½	Arm Height	25¾-30½	Weight	50
Depth	28½	Seat Depth	18			Cubic Ft.	19.2
Height	40½-45¼	Seat Width	21¾				

Mid Back with Upholstered Arm Caps



Quick Delivery Model: QN79BBC

		1	2/COM	3/COL	4	6	7	L7	L8
N79BBC		\$ 865	904	923	950	1035	1105	1440	1547
N79BBCJ	Jury Base	1090	1129	1148	1175	1260	1330	1665	1772

Dimensions

Width	26½	Seat Height	17¼-21½	Arm Height	25¾-30½	Weight	47
Depth	26½	Seat Depth	18			Cubic Ft.	15.6
Height	36-40¾	Seat Width	21¾				

Guest Wood Frame

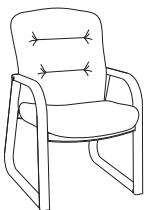

Quick Delivery Model: QN79CC

		1	2/COM	3/COL	4	6	7	L7	L8
N79CC		\$ 698	737	756	783	868	938	1273	1380

Dimensions

Width	24¾	Seat Height	17¾	Arm Height	24	Weight	37
Depth	26¾	Seat Depth	18¼			Cubic Ft.	14.3
Height	36	Seat Width	21¾				

To Order, Specify:

1. Model Number
2. Fabric Grade Number
3. Cover Number
4. Arm Cap Grade Number
5. Arm Cap Cover Number
6. Finish Designator
7. Casters

High Back with Contrasting Arm Caps



Model No.	Grade / List Price	Grade / List Price							
		Arm Cap Grade 1	Arm Cap Grade 2	Arm Cap Grade 3	Arm Cap Grade 4	Arm Cap Grade 6	Arm Cap Grade 7	Arm Cap Grade L7	Arm Cap Grade L8
N79AACX	Seat/Back Grade 1	\$ 942	953	958	965	988	1007	1097	1126
	Seat/Back Grade 2	975	986	991	998	1021	1040	1130	1159
	Seat/Back Grade 3	991	1002	1007	1014	1037	1056	1146	1175
	Seat/Back Grade 4	1014	1025	1030	1037	1060	1079	1169	1198
	Seat/Back Grade 6	1086	1097	1102	1109	1132	1151	1241	1270
	Seat/Back Grade 7	1145	1156	1161	1168	1191	1210	1300	1329
	Seat/Back Grade L7	1429	1440	1445	1452	1475	1494	1584	1613
	Seat/Back Grade L8	1519	1530	1535	1542	1565	1584	1674	1703

Dimensions

Width	26½	Seat Height	17¼-21½	Arm Height	25¾-30½	Weight	50
Depth	28½	Seat Depth	18			Cubic Ft.	19.2
Height	40½-45¼	Seat Width	21¾				

• When specifying an Alliance Program fabric on seating models with contrasting fabric options, use your electronic specification tool or contact customer service for pricing

Mid Back with Contrasting Arm Caps



Model No.	Grade / List Price	Grade / List Price							
		Arm Cap Grade 1	Arm Cap Grade 2	Arm Cap Grade 3	Arm Cap Grade 4	Arm Cap Grade 6	Arm Cap Grade 7	Arm Cap Grade L7	Arm Cap Grade L8
N79BBCX	Seat/Back Grade 1	\$ 911	920	925	932	952	969	1050	1075
	Seat/Back Grade 2	941	950	955	962	982	999	1080	1105
	Seat/Back Grade 3	955	964	969	976	996	1013	1094	1119
	Seat/Back Grade 4	976	985	990	997	1017	1034	1115	1140
	Seat/Back Grade 6	1040	1049	1054	1061	1081	1098	1179	1204
	Seat/Back Grade 7	1093	1102	1107	1114	1134	1151	1232	1257
	Seat/Back Grade L7	1347	1356	1361	1368	1388	1405	1486	1511
	Seat/Back Grade L8	1428	1437	1442	1449	1469	1486	1567	1592

Dimensions

Width	26½	Seat Height	17¼-21½	Arm Height	25¾-30½	Weight	47
Depth	26½	Seat Depth	18			Cubic Ft.	15.6
Height	36-40¾	Seat Width	21¾				

• When specifying an Alliance Program fabric on seating models with contrasting fabric options, use your electronic specification tool or contact customer service for pricing

Reno[®]

Reno

RENO PRODUCT SPECIFICATIONS

32 Series

FRAME CONSTRUCTION

- Interior frame is constructed of plywood with tenon joints that are glued and screwed for maximum joint stability
- Seat joints are supported by corner blocks with high tensile screws
- Reno Slim models feature a reduced footprint – see model dimensions for details

SEAT CONSTRUCTION

- Seat cushions are attached and feature 6" of high grade polyurethane foam, which is custom shaped and fabricated, and placed on high tension strip webbing

SEAT CONSTRUCTION — REMOVABLE SEAT CUSHION MODELS

- Removable seat cushions features 6" of high grade polyurethane foam, which is custom shaped and fabricated and placed on high tension strip webbing
- Seat cushions are secured with fastener clips

BACK CONSTRUCTION

- 5" of high grade polyurethane foam, which is custom shaped and stretched over web sheet and attached to frame

ARM CONSTRUCTION

- Armrest frames are wrapped with high grade polyurethane foam and slipcovered
- The frame is attached to the unit with three bolts per arm

WOOD ARM CONSTRUCTION

- Arms are molded of linear laminated hard maple veneers

CUP HOLDER

- Available on standard Reno upholstered arm

CONTRASTING FABRICS

- Available with three contrasting fabric locations: back, seat, and arms

LEGS

- Die-cast zinc legs are Platinum Metallic plated, Satin Nickel Metallic plated or Cinder powder coat paint and have nylon glides
- Wood legs are constructed of maple with nylon glides

HANDLE AND CASTERS

N32BB and N32DD

- Handle featured on mobile lounge is die-cast zinc that is Platinum Metallic plated, Satin Nickel Metallic plated or Cinder powder coat paint
- Heavy-duty black double wheel casters

TABLET ARM

- ¾" thick black thermofoil with MDF core or ¾" thick maple
- Attached with ¼" steel base plate and screws that mounts over ¾" metal insert rod and fits into structure of arm
- Tablet height is 28" from floor to top of tablet surface
- Allows for 360° swivel and writing surface of 21" W x 13½" D

BENCHES

- 8" of foam covers a ½" plywood panel on top of fiberboard frame
- Black, double wheel, roll control casters are standard and work on all floors

POWER GROMMET

- G23 black or silver grommet is available in right, left or both sides of the back for an additional upcharge
- Features two electrical receptacles and two power USB ports

TABLES

- Grade A slipmatched cherry or maple veneer or laminate
- Die-cast zinc legs with nylon glides
- Three power grommets available; specify cutout option and order electrical grommet model separately. See pages 463-464 for details and pricing

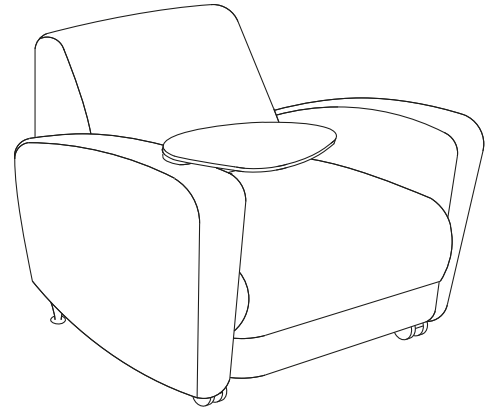

All Reno models may be ordered to meet TB133 fire code.

To order seating to meet the TB133 fire code, specify an "F" at the end of the model number (Ex: N32AAMF).

Reference pages 465-493 for TB133 Fabric Matrix and pricing.

Please consult customer service for applicable Arc-Com, COM, Maharam, Momentum, Stinson or Ultrafabrics fabric.



For comprehensive sustainability information that includes LEED® point contribution, visit NationalOfficeFurniture.ecoScorecard.com.

FABRICS

Grade 1	American Graffiti
	Cali
	Plush
	Ridge
	Speedway
Grade 2	Stardust
	Cathedral
	COM
	Orbit
	Pixie
	Sedona
	Shenanigans
	Spectrum
Grade 3	Strand
	Tranquility
	Twilight

Grade 3	Boardwalk
	COL
	Jacks
Grade 4	Pop Rocks
	Big City
	Bumble
	Connect Four
	Echo
Grade 6	Silvertex
	Essence/Ultraleather
	Flock
	Scribe

Grade 7	Brisa
	Brisa Distressed
	Promessa
	Silica
Grade L7	Davenport
Grade L8	Showcase

**LOUNGE
POWER GROMMET OPTIONS**

(\$443 list upcharge per location)

G23BL	Black, Left
G23BR	Black, Right
G23BLR	Black, Left & Right
G23SL	Silver, Left
G23SR	Silver, Right
G23SLR	Silver, Left & Right
X	No Grommet

**TABLES
SURFACE GROMMETS/CUTOUTS**

(\$25 list upcharge per location)

CUT-G12C	G12 Cutout, Center
CUT-G17C	G17 Cutout, Center
CUT-G23C	G23 Cutout, Center
X	No Grommet

**TABLES
SIDE GROMMETS/CUTOUTS**

(\$25 list upcharge per location)

CUT-G23C	G23 Cutout
X	No Grommet

If specifying cutout, reference pages 463-464 for pricing and details to order power grommet.

**FINISHES
(WOOD ARMS, LEGS AND TABLES)**

IM	Brighton	CW	Cordovan
NM	Natural	DW	Judicial
HN	Honey	MH	Mocha
CL	Caramel	*405	Designer White
TF	Truffle	*462	Cinder
AC	Autumn	*792	Sable
MC	Amber	*793	Acorn

*Not available on tables

**LAMINATES
(TABLES ONLY)**

IM	Brighton	405	Designer White
NM	Natural	417	Mojave
HN2	Honey 2	418	Mouse
CL	Caramel	419	Wallaby
TF	Truffle	425	Shadow
AC2	Autumn 2	440	Cloud
MC	Amber	461	Graphite
CW	Cordovan	462	Cinder
DW	Judicial	478	Platinum Grey
MH	Mocha	488	Frosty White
*791	Palisander	491	Designer White Linear
792	Sable	492	Cinder Linear
793	Acorn		

*791 Palisander coordinates with (NM) Natural, (HN) Honey and (MH) Mocha finishes

**PAINT COLORS
(LEGS AND HANDLE)**

462	Cinder
501	Platinum Metallic
503	Satin Nickel Metallic

CUP HOLDER OPTIONS

(\$60 list upcharge per location)

CPL	Cup Holder, Left
CPR	Cup Holder, Right
CPLR	Cup Holder, Left & Right

• Cannot have cupholder and tablet on same arm

TABLET ARM

T	Thermofoil, Black
W405	Wood, Designer White
W462	Wood, Cinder
W792	Wood, Sable
W793	Wood, Acorn
WAC	Wood, Autumn
WCL	Wood, Caramel
WCW	Wood, Cordovan
WDW	Wood, Judicial
WHN	Wood, Honey
WIM	Wood, Brighton
WMC	Wood, Amber
WMH	Wood, Mocha
WNM	Wood, Natural
WTF	Wood, Truffle

To Order, Specify:

1. Model Number
2. Fabric Grade / Cover Number
3. Power Grommet
4. Cup Holder
5. Paint (when applicable)
6. Wood Leg Finish (when applicable)

• See page 331 for Reno options

One Seat Lounge

Model No. Grade / List Price

Quick Delivery Models: QN32AAM, QN32AAW

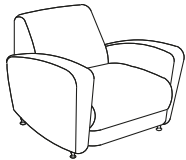

Metal Legs

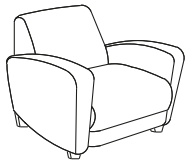

Wood Legs

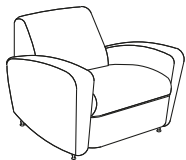

Removable Seat Cushion

		1	2/COM	3/COL	4	6	7	L7	L8
N32AAM	Metal Legs	\$ 1576	1689	1743	1821	2066	2267	3232	3541
N32AAW	Wood Legs	1692	1805	1859	1937	2182	2383	3348	3657
N32AAMS	Metal Legs – Removable Seat Cushion	1663	1778	1833	1913	2163	2368	3353	3668
N32AAWS	Wood Legs – Removable Seat Cushion	1780	1895	1950	2030	2280	2485	3470	3785

Dimensions

Width	34½	Arm Height	27	Seat Width	22	Weight	83
Depth	34½	Seat Height	19			Cubic Ft.	32
Height	33	Seat Depth	21¼				

• Contrasting fabric option – specify X (i.e., N32AAMX). For list pricing, use your electronic specification tool or contact customer service

To Order Contrasting Fabric, Specify:

1. Model Number plus “X”
2. Back Fabric Grade Number/Cover Number
3. Seat Fabric Grade Number/Cover Number
4. Arm Fabric Grade Number/Cover Number
5. Power Grommet
6. Cup Holder
7. Paint (when applicable)
8. Wood Leg Finish (when applicable)

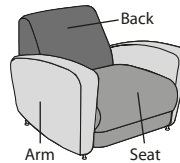

Contrasting Fabric

**Mobile
One Seat Lounge**

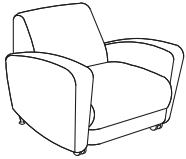

Metal Legs

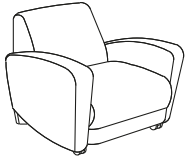

Wood Legs

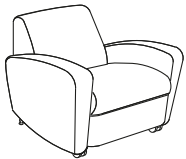

Removable Seat Cushion

**Model
No.**

Grade / List Price

		1	2/COM	3/COL	4	6	7	L7	L8
N32BBM	Metal Legs	\$ 1723	1836	1890	1968	2213	2414	3379	3688
N32BBW	Wood Legs	1841	1954	2008	2086	2331	2532	3497	3806
N32BBMS	Metal Legs – Removable Seat Cushion	1780	1895	1950	2030	2280	2485	3470	3785
N32BBWS	Wood Legs – Removable Seat Cushion	1928	2043	2098	2178	2428	2633	3618	3933

Dimensions

Width	34½	Arm Height	27	Seat Width	22	Weight	83
Depth	34½	Seat Height	19			Cubic Ft.	32
Height	33	Seat Depth	21¼				

- Contrasting fabric option – specify X (i.e., N32BBMX). For list pricing, use your electronic specification tool or contact customer service
- Features a handle on the back for ease of mobility
- Paint finish option represents handle on wood leg models and legs and handle on metal leg models

To Order Contrasting Fabric, Specify:

1. Model Number plus "X"
2. Back Fabric Grade Number/Cover Number
3. Seat Fabric Grade Number/Cover Number
4. Arm Fabric Grade Number/Cover Number
5. Power Grommet
6. Cup Holder
7. Paint (when applicable)
8. Wood Leg Finish (when applicable)

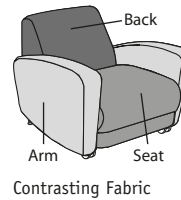

To Order, Specify:

1. Model Number
2. Fabric Grade / Cover Number
3. Power Grommet
4. Cup Holder
5. Tablet and Finish (when applicable)
6. Paint (when applicable)
7. Wood Leg Finish (when applicable)

• See page 331 for Reno options

One Seat Lounge with Tablet

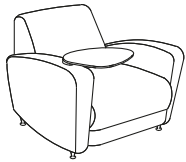

Metal Legs

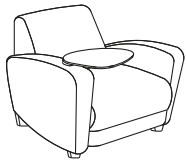

Wood Legs

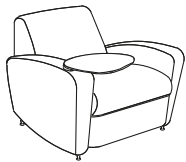

Removable Seat Cushion

Model No.	Grade / List Price								
		1	2/COM	3/COL	4	6	7	L7	L8
N32CCMR	Metal Legs, Tablet Right Arm	\$ 1948	2061	2115	2193	2438	2639	3604	3913
N32CCML	Metal Legs, Tablet Left Arm	1948	2061	2115	2193	2438	2639	3604	3913
N32CCWR	Wood Legs, Tablet Right Arm	2065	2178	2232	2310	2555	2756	3721	4030
N32CCWL	Wood Legs, Tablet Left Arm	2065	2178	2232	2310	2555	2756	3721	4030
N32CCMRS	Metal Legs, Tablet Right Arm, Removable Seat Cushion	2036	2151	2206	2286	2536	2741	3726	4041
N32CCMLS	Metal Legs, Tablet Left Arm, Removable Seat Cushion	2036	2151	2206	2286	2536	2741	3726	4041
N32CCWRS	Wood Legs, Tablet Right Arm, Removable Seat Cushion	2153	2268	2323	2403	2653	2858	3843	4158
N32CCWLS	Wood Legs, Tablet Left Arm, Removable Seat Cushion	2153	2268	2323	2403	2653	2858	3843	4158

Dimensions

Width	34½	Arm Height	27	Seat Width	22	Weight	95
Depth	34½	Seat Height	19			Cubic Ft.	32
Height	33	Seat Depth	21¼				

- Contrasting fabric option – specify X (i.e., N32CCMRX). For list pricing, use your electronic specification tool or contact customer service
- Tablet available in black thermofoil or veneer
- Veneer tablet available in all wood finishes and Cinder

To Order Contrasting Fabric, Specify:

1. Model Number plus "X"
2. Back Fabric Grade Number/Cover Number
3. Seat Fabric Grade Number/Cover Number
4. Arm Fabric Grade Number/Cover Number
5. Power Grommet
6. Tablet and Finish
7. Cup Holder
8. Paint (when applicable)
9. Wood Leg Finish (when applicable)

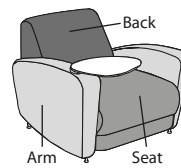

Contrasting Fabric

**Mobile
One Seat Lounge
with Tablet**

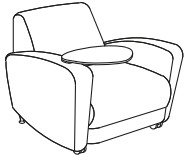

Metal Legs

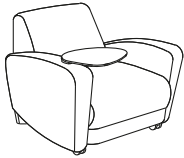

Wood Legs

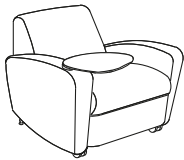

Removable Seat Cushion

**Model
No.**

Grade / List Price

		1	2/COM	3/COL	4	6	7	L7	L8
N32DDMR	Metal Legs, Tablet Right Arm	\$ 2083	2196	2250	2328	2573	2774	3739	4048
N32DDML	Metal Legs, Tablet Left Arm	2083	2196	2250	2328	2573	2774	3739	4048
N32DDWR	Wood Legs, Tablet Right Arm	2199	2312	2366	2444	2689	2890	3855	4164
N32DDWL	Wood Legs, Tablet Left Arm	2199	2312	2366	2444	2689	2890	3855	4164
N32DDMRS	Metal Legs, Tablet Right Arm, Removable Seat Cushion	2170	2285	2340	2420	2670	2875	3860	4175
N32DDMLS	Metal Legs, Tablet Left Arm, Removable Seat Cushion	2170	2285	2340	2420	2670	2875	3860	4175
N32DDWRS	Wood Legs, Tablet Right Arm, Removable Seat Cushion	2288	2403	2458	2538	2788	2993	3978	4293
N32DDWLS	Wood Legs, Tablet Left Arm, Removable Seat Cushion	2288	2403	2458	2538	2788	2993	3978	4293

Dimensions

Width	34½	Arm Height	27	Seat Width	22	Weight	95
Depth	34½	Seat Height	19			Cubic Ft.	32
Height	33	Seat Depth	21¼				

- Contrasting fabric option – specify X (i.e., N32DDMRX). For list pricing, use your electronic specification tool or contact customer service
- Tablet available in black thermofoil or veneer
- Veneer tablet available in all wood finishes and Cinder
- Features a handle on the back for ease of mobility
- Paint finish option represents handle on wood leg models and legs and handle on metal leg models

To Order Contrasting Fabric, Specify:

1. Model Number plus "X"
2. Back Fabric Grade Number/Cover Number
3. Seat Fabric Grade Number/Cover Number
4. Arm Fabric Grade Number/Cover Number
5. Power Grommet
6. Tablet and Finish
7. Cup Holder
8. Paint (when applicable)
9. Wood Leg Finish (when applicable)

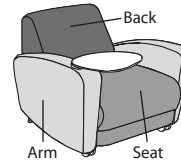

Contrasting Fabric

To Order, Specify:

1. Model Number
2. Fabric Grade / Cover Number
3. Power Grommet
4. Cup Holder
5. Tablet and Finish (when applicable)
6. Paint (when applicable)
7. Wood Leg Finish (when applicable)

• See page 331 for Reno options

2½ Seat Lounge

Model No.

Grade / List Price

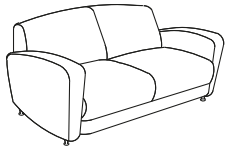

Metal Legs

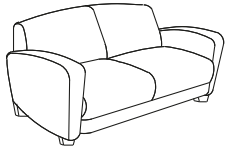

Wood Legs

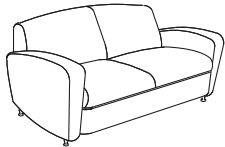

Removable Seat Cushions

		1	2/COM	3/COL	4	6	7	L7	L8
N32HHM	Metal Legs	\$ 2099	2306	2405	2549	2999	3368	5141	5708
N32HHW	Wood Legs	2217	2424	2523	2667	3117	3486	5259	5826
N32HHMS	Metal Legs – Removable Seat Cushion	2187	2419	2530	2692	3197	3611	5601	6237
N32HHWS	Wood Legs – Removable Seat Cushion	2303	2535	2646	2808	3313	3727	5717	6353

Dimensions

Width	67½	Arm Height	27	Seat Width	55¾	Weight	125
Depth	34½	Seat Height	19			Cubic Ft.	56.1
Height	33	Seat Depth	21¼				

• Contrasting fabric option – specify X (i.e., N32HHMX). For list pricing, use your electronic specification tool or contact customer service

To Order Contrasting Fabric, Specify:

1. Model Number plus “X”
2. Back Fabric Grade Number/Cover Number
3. Seat Fabric Grade Number/Cover Number
4. Arm Fabric Grade Number/Cover Number
5. Power Grommet
6. Cup Holder
7. Paint (when applicable)
8. Wood Leg Finish (when applicable)

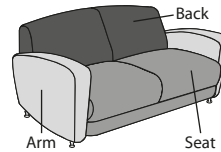

Contrasting Fabric

2½ Seat Lounge with Tablet

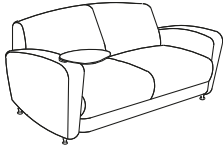

Metal Legs

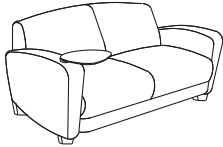

Wood Legs

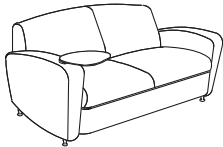

Removable Seat Cushions

Model No.

Grade / List Price

		1	2/COM	3/COL	4	6	7	L7	L8
N32JJMR	Metal Legs, Tablet Right Arm	\$ 2471	2678	2777	2921	3371	3740	5513	6080
N32JJML	Metal Legs, Tablet Left Arm	2471	2678	2777	2921	3371	3740	5513	6080
N32JJMB	Metal Legs, Tablet Both Arms	2843	3050	3149	3293	3743	4112	5885	6452
N32JJWR	Wood Legs, Tablet Right Arm	2587	2794	2893	3037	3487	3856	5629	6196
N32JJWL	Wood Legs, Tablet Left Arm	2587	2794	2893	3037	3487	3856	5629	6196
N32JJWB	Wood Legs, Tablet Both Arms	2960	3167	3266	3410	3860	4229	6002	6569
N32JJMRS	Metal Legs, Tablet Right Arm, Removable Seat Cushion	2557	2789	2900	3062	3567	3981	5971	6607
N32JJMLS	Metal Legs, Tablet Left Arm, Removable Seat Cushion	2557	2789	2900	3062	3567	3981	5971	6607
N32JJMBS	Metal Legs, Tablet Both Arms, Removable Seat Cushion	2930	3162	3273	3435	3940	4354	6344	6980
N32JJWRS	Wood Legs, Tablet Right Arm, Removable Seat Cushion	2675	2907	3018	3180	3685	4099	6089	6725
N32JJWLS	Wood Legs, Tablet Left Arm, Removable Seat Cushion	2675	2907	3018	3180	3685	4099	6089	6725
N32JJWBS	Wood Legs, Tablet Both Arms, Removable Seat Cushion	3048	3280	3391	3553	4058	4472	6462	7098

Dimensions

Width	67½	Arm Height	27	Seat Width	55¾	Weight	137
Depth	34½	Seat Height	19			Cubic Ft.	56.1
Height	33	Seat Depth	21¼			Weight with Tablet Both Arms	149

- Contrasting fabric option – specify X (i.e., N32JJMRX). For list pricing, use your electronic specification tool or contact customer service
- Tablet available in black thermofoil or veneer
- Veneer tablet available in all wood finishes and Cinder

To Order Contrasting Fabric, Specify:

1. Model Number plus “X”
2. Back Fabric Grade Number/Cover Number
3. Seat Fabric Grade Number/Cover Number
4. Arm Fabric Grade Number/Cover Number
5. Power Grommet
6. Tablet and Finish
7. Cup Holder
8. Paint (when applicable)
9. Wood Leg Finish (when applicable)

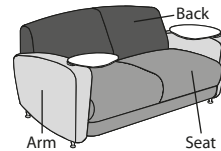

Contrasting Fabric

To Order, Specify:

1. Model Number
2. Fabric Grade / Cover Number
3. Power Grommet
4. Cup Holder
5. Tablet and Finish (when applicable)
6. Paint (when applicable)
7. Wood Leg Finish (when applicable)

• See page 331 for Reno options

Three Seat Lounge

Model No.

Grade / List Price

		1	2/COM	3/COL	4	6	7	L7	L8
N32LLM	Metal Legs	\$ 2622	2827	2925	3067	3512	3877	5630	6191
N32LLW	Wood Legs	2739	2944	3042	3184	3629	3994	5747	6308
N32LLMS	Metal Legs – Removable Seat Cushion	2710	2933	3040	3195	3680	4078	5989	6600
N32LLWS	Wood Legs – Removable Seat Cushion	2827	3050	3157	3312	3797	4195	6106	6717

Dimensions

Width	78	Arm Height	27	Seat Width	66¼	Weight	148
Depth	34½	Seat Height	19			Cubic Ft.	69.4
Height	33	Seat Depth	21¼				

- Contrasting fabric option – specify X (i.e., N32LLMX). For list pricing, use your electronic specification tool or contact customer service

To Order Contrasting Fabric, Specify:

1. Model Number plus “X”
2. Back Fabric Grade Number/Cover Number
3. Seat Fabric Grade Number/Cover Number
4. Arm Fabric Grade Number/Cover Number
5. Power Grommet
6. Cup Holder
7. Paint (when applicable)
8. Wood Leg Finish (when applicable)

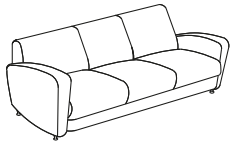
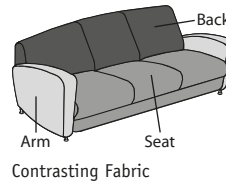

Metal Legs

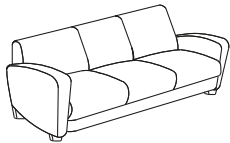

Wood Legs

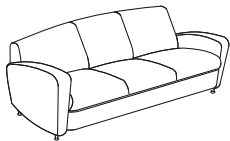

Removable Seat Cushion

Three Seat Lounge with Tablet

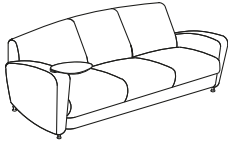

Metal Legs

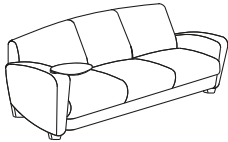

Wood Legs

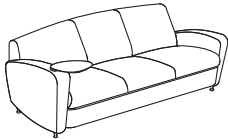

Removable Seat Cushion

Model No.		Grade / List Price							
		1	2/COM	3/COL	4	6	7	L7	L8
N32MMMR	Metal Legs, Tablet Right Arm	\$ 2994	3199	3297	3439	3884	4249	6002	6563
N32MMML	Metal Legs, Tablet Left Arm	2994	3199	3297	3439	3884	4249	6002	6563
N32MMMB	Metal Legs, Tablet Both Arms	3366	3571	3669	3811	4256	4621	6374	6935
N32MMWR	Wood Legs, Tablet Right Arm	3111	3316	3414	3556	4001	4366	6119	6680
N32MMWL	Wood Legs, Tablet Left Arm	3111	3316	3414	3556	4001	4366	6119	6680
N32MMWB	Wood Legs, Tablet Both Arms	3484	3689	3787	3929	4374	4739	6492	7053
N32MMMRS	Metal Legs, Tablet Right Arm, Removable Seat Cushion	3082	3305	3412	3567	4052	4450	6361	6972
N32MMMLS	Metal Legs, Tablet Left Arm, Removable Seat Cushion	3082	3305	3412	3567	4052	4450	6361	6972
N32MMBBS	Metal Legs, Tablet Both Arms, Removable Seat Cushion	3455	3678	3785	3940	4425	4823	6734	7345
N32MMWRS	Wood Legs, Tablet Right Arm, Removable Seat Cushion	3198	3421	3528	3683	4168	4566	6477	7088
N32MMWLS	Wood Legs, Tablet Left Arm, Removable Seat Cushion	3198	3421	3528	3683	4168	4566	6477	7088
N32MMWBS	Wood Legs, Tablet Both Arms, Removable Seat Cushion	3571	3794	3901	4056	4541	4939	6850	7461

Dimensions

Width	78	Arm Height	27	Seat Width	66¼	Weight	160
Depth	34½	Seat Height	19			Cubic Ft.	69.4
Height	33	Seat Depth	21¼			Weight with Tablet Both Arms	172

- Contrasting fabric option – specify X (i.e., N32MMMRX). For list pricing, use your electronic specification tool or contact customer service
- Tablet available in black thermofoil or veneer
- Veneer tablet available in all wood finishes and Cinder

To Order Contrasting Fabric, Specify:

1. Model Number plus "X"
2. Back Fabric Grade Number/Cover Number
3. Seat Fabric Grade Number/Cover Number
4. Arm Fabric Grade Number/Cover Number
5. Power Grommet
6. Tablet and Finish
7. Cup Holder
8. Paint (when applicable)
9. Wood Leg Finish (when applicable)

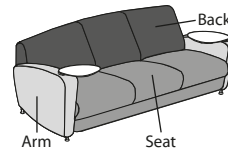

Contrasting Fabric

To Order, Specify:

1. Model Number
2. Fabric Grade Number
3. Cover Number
4. Power Grommet
5. Paint (when applicable)
6. Finish Designator (when applicable)
7. Glides

• See page 331 for Reno options

**One Seat Lounge
Wood Arms**

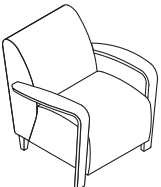

Wood Arms

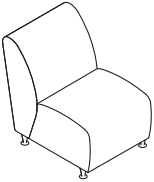

Armless – Metal Legs

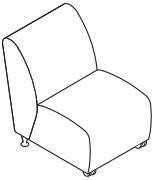

Armless – Metal Legs – Mobile

Model No.	Grade / List Price	Grade / List Price							
		1	2/COM	3/COL	4	6	7	L7	L8
N32TAAW	Wood Legs	\$ 2223	2287	2318	2363	2503	2618	3169	3346
N32MAAM	Armless – Metal Legs	1466	1530	1561	1606	1746	1861	2412	2589
N32MAAW	Armless – Wood Legs	1583	1647	1678	1723	1863	1978	2529	2706
N32MBBM	Armless – Metal Legs – Mobile	1614	1678	1709	1754	1894	2009	2560	2737
N32MBBW	Armless – Wood Legs – Mobile	1731	1795	1826	1871	2011	2126	2677	2854

Dimensions

Width	32	Seat Height	19	Arm Height	27	Armless Weight	52
Armless Width	23	Seat Depth	21¼			Arm Weight	65
Depth	34½	Seat Width	22½			Armless Cubic Ft.	28.0
Height	33					Arm Cubic Ft.	32.0

- Contrasting fabric option – specify X (i.e., N32TAAWX). For list pricing, use your electronic specification tool or contact customer service
- Cup holder not available

To Order Contrasting Fabric, Specify:

1. Model Number plus “X”
2. Back Fabric Grade Number/Cover Number
3. Seat Fabric Grade Number/Cover Number
4. Power Grommet
5. Paint (when applicable)
6. Finish Designator (when applicable)
7. Glides

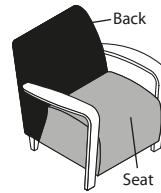

Contrasting Upholstery

**2½ Seat Lounge
Wood Arms**

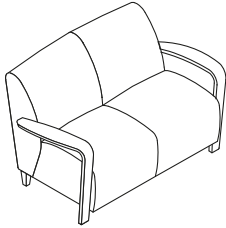

Wood Arms

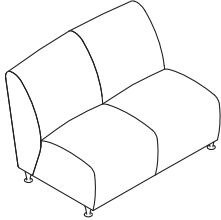

Armless – Metal Legs

**Model
No.**

Grade / List Price

		1	2/COM	3/COL	4	6	7	L7	L8
N32THHW	Wood Legs	\$ 2747	2899	2971	3077	3407	3678	4978	5394
N32MHHM	Armless – Metal Legs	1990	2142	2214	2320	2650	2921	4221	4637
N32MHHW	Armless – Wood Legs	2107	2259	2331	2437	2767	3038	4338	4754

Dimensions

Width	65	Seat Height	19	Arm Height	27	Armless Weight	97
Armless Width	56	Seat Depth	21¼			Arm Weight	110
Depth	34½	Seat Width	55½			Armless Cubic Ft.	49.7
Height	33					Arm Cubic Ft.	56.1

- Contrasting fabric option – specify X (i.e., N32THHWX). For list pricing, use your electronic specification tool or contact customer service
- Cup holder not available

**Three Seat Lounge
Wood Arms**

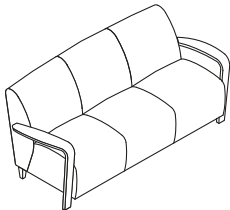

Wood Arms

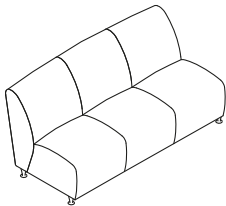

Armless – Metal Legs

		1	2/COM	3/COL	4	6	7	L7	L8
N32TLLW	Wood Legs	\$ 3269	3400	3463	3554	3839	4073	5196	5555
N32MLLM	Armless – Metal Legs	2513	2644	2707	2798	3083	3317	4440	4799
N32MLLW	Armless – Wood Legs	2630	2761	2824	2915	3200	3434	4557	4916

Dimensions

Width	75½	Seat Height	19	Arm Height	27	Armless Weight	118
Armless Width	66½	Seat Depth	21¼			Arm Weight	133
Depth	34½	Seat Width	66			Armless Cubic Ft.	56.1
Height	33					Arm Cubic Ft.	69.4

- Contrasting fabric option – specify X (i.e., N32TLLWX). For list pricing, use your electronic specification tool or contact customer service
- Cup holder not available

To Order Contrasting Fabric, Specify:

1. Model Number plus “X”
2. Back Fabric Grade Number/Cover Number
3. Seat Fabric Grade Number/Cover Number
4. Power Grommet
5. Paint (when applicable)
6. Wood Leg Finish (when applicable)
7. Glides

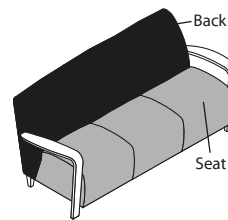

Contrasting Upholstery

To Order, Specify:

1. Model Number
2. Fabric Grade Number
3. Cover Number
4. Power Grommet
5. Paint (when applicable)
6. Wood Leg Finish (when applicable)

• See page 331 for Reno options

One Seat Lounge - Slim

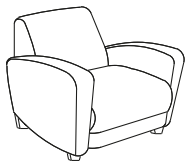

Wood Legs

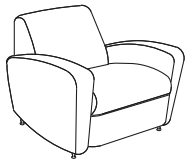

Removable Seat Cushion

Model No.	Grade / List Price								
		1	2/COM	3/COL	4	6	7	L7	L8
N32SAAM	Metal Legs	\$ 1576	1689	1743	1821	2066	2267	3232	3541
N32SAAW	Wood Legs	1692	1805	1859	1937	2182	2383	3348	3657
N32SAAMS	Metal Legs – Removable Seat Cushion	1663	1778	1833	1913	2163	2368	3353	3668
N32SAAWS	Wood Legs – Removable Seat Cushion	1780	1895	1950	2030	2280	2485	3470	3785

Dimensions

Width	32	Arm Height	27	Seat Width	22	Weight	74
Armless Width	23	Seat Height	19			Cubic Ft.	32.0
Depth	31	Seat Depth	21¼				
Height	33						

- Contrasting fabric option – specify X (i.e., N32SAAMX). For list pricing, use your electronic specification tool or contact customer service
- Cup holder not available

To Order Contrasting Fabric, Specify:

1. Model Number plus “X”
2. Back Fabric Grade Number/Cover Number
3. Seat Fabric Grade Number/Cover Number
4. Arm Fabric Grade Number/Cover Number
5. Power Grommet
6. Paint (when applicable)
7. Wood Leg Finish (when applicable)

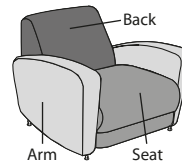

Contrasting Fabric

**Mobile
One Seat Lounge - Slim**

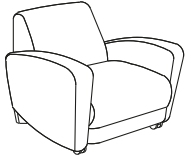

Wood Legs

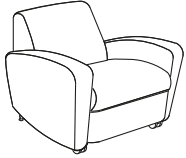

Removable Seat Cushion

**Model
No.**

Grade / List Price

		1	2/COM	3/COL	4	6	7	L7	L8
N32SBBM	Metal Legs	\$ 1723	1836	1890	1968	2213	2414	3379	3688
N32SBBW	Wood Legs	1841	1954	2008	2086	2331	2532	3497	3806
N32SBBMS	Metal Legs – Removable Seat Cushion	1780	1895	1950	2030	2280	2485	3470	3785
N32SBBWS	Wood Legs – Removable Seat Cushion	1928	2043	2098	2178	2428	2633	3618	3933

Dimensions

Width	32	Arm Height	27	Seat Width	22	Weight	74
Armless Width	23	Seat Height	19			Cubic Ft.	32.0
Depth	31	Seat Depth	21¼				
Height	33						

- Contrasting fabric option – specify X (i.e., N32SBBMX). For list pricing, use your electronic specification tool or contact customer service
- Features a handle on the back for ease of mobility
- Paint finish option represents handle on wood leg models and legs and handle on metal leg models
- Cup holder not available

To Order Contrasting Fabric, Specify:

1. Model Number plus "X"
2. Back Fabric Grade Number/Cover Number
3. Seat Fabric Grade Number/Cover Number
4. Arm Fabric Grade Number/Cover Number
5. Power Grommet
6. Paint (when applicable)
7. Wood Leg Finish (when applicable)

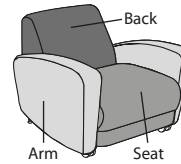

Contrasting Fabric

To Order, Specify:

1. Model Number
2. Fabric Grade Number
3. Cover Number
4. Power Grommet
5. Tablet and Finish (when applicable)
6. Paint (when applicable)
7. Wood Leg Finish (when applicable)

• See page 331 for Reno options

One Seat Lounge with Tablet - Slim

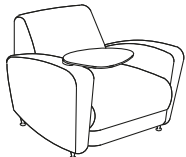

Metal Legs

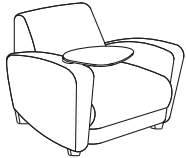

Wood Legs

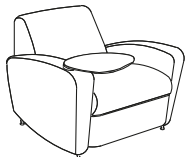

Removable Seat Cushion

Model No.	Grade / List Price	Grade / List Price							
		1	2/COM	3/COL	4	6	7	L7	L8
N32SCCMR	Metal Legs, Tablet Right Arm	\$ 1948	2061	2115	2193	2438	2639	3604	3913
N32SCCML	Metal Legs, Tablet Left Arm	1948	2061	2115	2193	2438	2639	3604	3913
N32SCCWR	Wood Legs, Tablet Right Arm	2065	2178	2232	2310	2555	2756	3721	4030
N32SCCWL	Wood Legs, Tablet Left Arm	2065	2178	2232	2310	2555	2756	3721	4030
N32SCCMRS	Metal Legs, Tablet Right Arm, Removable Seat Cushion	2036	2151	2206	2286	2536	2741	3726	4041
N32SCCMLS	Metal Legs, Tablet Left Arm, Removable Seat Cushion	2036	2151	2206	2286	2536	2741	3726	4041
N32SCCWRS	Wood Legs, Tablet Right Arm, Removable Seat Cushion	2153	2268	2323	2403	2653	2858	3843	4158
N32SCCWLS	Wood Legs, Tablet Left Arm, Removable Seat Cushion	2153	2268	2323	2403	2653	2858	3843	4158

Dimensions

Width	32	Arm Height	27	Seat Width	22	Weight	87
Depth	31	Seat Height	19			Cubic Ft.	32.0
Height	33	Seat Depth	21¼				

- Contrasting fabric option – specify X (i.e., N32SCCMRX). For list pricing, use your electronic specification tool or contact customer service
- Tablet available in black thermofoil or veneer
- Veneer tablet available in all wood finishes and Cinder
- Cup holder not available

To Order Contrasting Fabric, Specify:

1. Model Number plus “X”
2. Back Fabric Grade Number/Cover Number
3. Seat Fabric Grade Number/Cover Number
4. Arm Fabric Grade Number/Cover Number
5. Power Grommet
6. Tablet and Finish (when applicable)
7. Paint (when applicable)
8. Wood Leg Finish (when applicable)

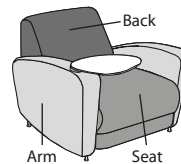

Contrasting Fabric

**Mobile
One Seat Lounge
with Tablet - Slim**

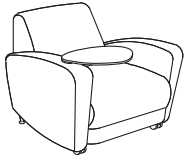

Metal Legs

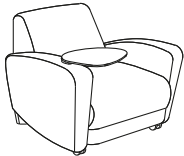

Wood Legs

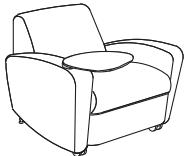

Removable Seat Cushion

**Model
No.**

Grade / List Price

		1	2/COM	3/COL	4	6	7	L7	L8
N32SDDMR	Metal Legs, Tablet Right Arm	\$ 2083	2196	2250	2328	2573	2774	3739	4048
N32SDDML	Metal Legs, Tablet Left Arm	2083	2196	2250	2328	2573	2774	3739	4048
N32SDDWR	Wood Legs, Tablet Right Arm	2199	2312	2366	2444	2689	2890	3855	4164
N32SDDWL	Wood Legs, Tablet Left Arm	2199	2312	2366	2444	2689	2890	3855	4164
N32SDDMRS	Metal Legs, Tablet Right Arm, Removable Seat Cushion	2170	2285	2340	2420	2670	2875	3860	4175
N32SDDMLS	Metal Legs, Tablet Left Arm, Removable Seat Cushion	2170	2285	2340	2420	2670	2875	3860	4175
N32SDDWRS	Wood Legs, Tablet Right Arm, Removable Seat Cushion	2288	2403	2458	2538	2788	2993	3978	4293
N32SDDWLS	Wood Legs, Tablet Left Arm, Removable Seat Cushion	2288	2403	2458	2538	2788	2993	3978	4293

Dimensions

Width	32	Arm Height	27	Seat Width	22	Weight	87
Depth	31	Seat Height	19			Cubic Ft.	32.0
Height	33	Seat Depth	21¼				

- Contrasting fabric option – specify X (i.e., N32SDDMRX). For list pricing, use your electronic specification tool or contact customer service
- Tablet available in black thermofoil or veneer
- Veneer tablet available in all wood finishes and Cinder
- Features a handle on the back for ease of mobility
- Paint finish option represents handle on wood leg models and legs and handle on metal leg models
- Cup holder not available

To Order Contrasting Fabric, Specify:

1. Model Number plus “X”
2. Back Fabric Grade Number/Cover Number
3. Seat Fabric Grade Number/Cover Number
4. Arm Fabric Grade Number/Cover Number
5. Power Grommet
6. Tablet and Finish (when applicable)
7. Paint (when applicable)
8. Wood Leg Finish (when applicable)

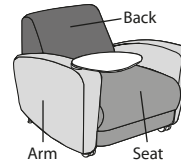

Contrasting Fabric

To Order, Specify:

1. Model Number
2. Fabric Grade Number
3. Cover Number
4. Power Grommet
5. Tablet and Finish (when applicable)
6. Paint (when applicable)
7. Wood Leg Finish (when applicable)

• See page 331 for Reno options

2½ Seat Lounge - Slim

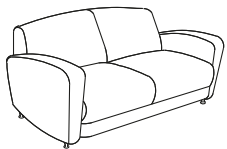

Metal Legs

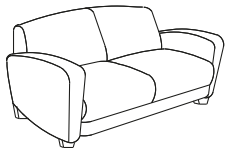

Wood Legs

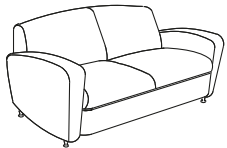

Removable Seat Cushions

Model No.

Grade / List Price

		1	2/COM	3/COL	4	6	7	L7	L8
N32SHHM	Metal Legs	\$ 2099	2306	2405	2549	2999	3368	5141	5708
N32SHHW	Wood Legs	2217	2424	2523	2667	3117	3486	5259	5826
N32SHHMS	Metal Legs – Removable Seat Cushion	2187	2419	2530	2692	3197	3611	5601	6237
N32SHHWS	Wood Legs – Removable Seat Cushion	2303	2535	2646	2808	3313	3727	5717	6353

Dimensions

Width	65	Arm Height	27	Seat Width	55¾	Weight	117
Depth	31	Seat Height	19			Cubic Ft.	56.0
Height	33	Seat Depth	21¼				

- Contrasting fabric option – specify X (i.e., N32SHHM^X). For list pricing, use your electronic specification tool or contact customer service
- Cup holder not available

To Order Contrasting Fabric, Specify:

1. Model Number plus “X”
2. Back Fabric Grade Number/Cover Number
3. Seat Fabric Grade Number/Cover Number
4. Arm Fabric Grade Number/Cover Number
5. Power Grommet
6. Paint (when applicable)
7. Wood Leg Finish (when applicable)

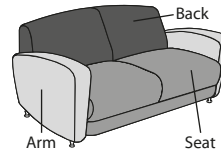

Contrasting Fabric

2½ Seat Lounge with Tablet - Slim

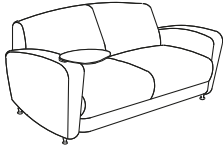

Metal Legs

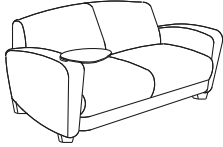

Wood Legs

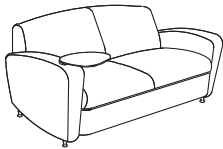

Removable Seat Cushions

Model No.

Grade / List Price

		1	2/COM	3/COL	4	6	7	L7	L8
N32SJJMR	Metal Legs, Tablet Right Arm	\$ 2471	2678	2777	2921	3371	3740	5513	6080
N32SJJML	Metal Legs, Tablet Left Arm	2471	2678	2777	2921	3371	3740	5513	6080
N32SJJMB	Metal Legs, Tablet Both Arms	2843	3050	3149	3293	3743	4112	5885	6452
N32SJJWR	Wood Legs, Tablet Right Arm	2587	2794	2893	3037	3487	3856	5629	6196
N32SJJWL	Wood Legs, Tablet Left Arm	2587	2794	2893	3037	3487	3856	5629	6196
N32SJJWB	Wood Legs, Tablet Both Arms	2960	3167	3266	3410	3860	4229	6002	6569
N32SJJMRS	Metal Legs, Tablet Right Arm, Removable Seat Cushion	2557	2789	2900	3062	3567	3981	5971	6607
N32SJJMLS	Metal Legs, Tablet Left Arm, Removable Seat Cushion	2557	2789	2900	3062	3567	3981	5971	6607
N32SJJMBS	Metal Legs, Tablet Both Arms, Removable Seat Cushion	2930	3162	3273	3435	3940	4354	6344	6980
N32SJJWRS	Wood Legs, Tablet Right Arm, Removable Seat Cushion	2675	2907	3018	3180	3685	4099	6089	6725
N32SJJWLS	Wood Legs, Tablet Left Arm, Removable Seat Cushion	2675	2907	3018	3180	3685	4099	6089	6725
N32SJJWBS	Wood Legs, Tablet Both Arms, Removable Seat Cushion	3048	3280	3391	3553	4058	4472	6462	7098

Dimensions

Width	65	Arm Height	27	Seat Width	55¾	Weight	129
Depth	31	Seat Height	19			Cubic Ft.	56.1
Height	33	Seat Depth	21¼			Weight with Tablet Both Arms	141

- Contrasting fabric option – specify X (i.e., N32SJJMRX). For list pricing, use your electronic specification tool or contact customer service
- Tablet available in black thermofoil or veneer
- Veneer tablet available in all wood finishes and Cinder
- Cup holder not available

To Order Contrasting Fabric, Specify:

1. Model Number plus "X"
2. Back Fabric Grade Number/Cover Number
3. Seat Fabric Grade Number/Cover Number
4. Arm Fabric Grade Number/Cover Number
5. Power Grommet
6. Tablet and Finish (when applicable)
7. Paint (when applicable)
8. Wood Leg Finish (when applicable)

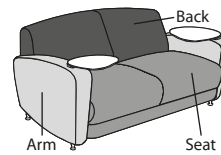

Contrasting Fabric

To Order, Specify:

1. Model Number
2. Fabric Grade Number
3. Cover Number
4. Power Grommet
5. Tablet and Finish (when applicable)
6. Paint (when applicable)
7. Wood Leg Finish (when applicable)

• See page 331 for Reno options

Three Seat Lounge - Slim

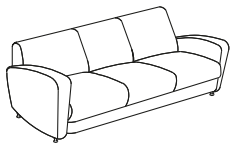

Metal Legs

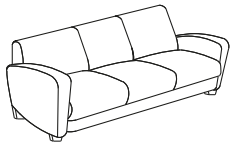

Wood Legs

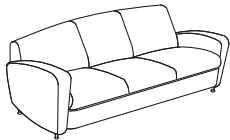

Removable Seat Cushion

Model No.

Grade / List Price

		1	2/COM	3/COL	4	6	7	L7	L8
N32SLLM	Metal Legs	\$ 2622	2827	2925	3067	3512	3877	5630	6191
N32SLLW	Wood Legs	2739	2944	3042	3184	3629	3994	5747	6308
N32SLLMS	Metal Legs – Removable Seat Cushion	2710	2933	3040	3195	3680	4078	5989	6600
N32SLLWS	Wood Legs – Removable Seat Cushion	2827	3050	3157	3312	3797	4195	6106	6717

Dimensions

Width	75½	Arm Height	27	Seat Width	66¼	Weight	139
Depth	31	Seat Height	19			Cubic Ft.	69.4
Height	33	Seat Depth	21¼				

- Contrasting fabric option – specify X (i.e., N32SLLMX). For list pricing, use your electronic specification tool or contact customer service
- Cup holder not available

To Order Contrasting Fabric, Specify:

1. Model Number plus “X”
2. Back Fabric Grade Number/Cover Number
3. Seat Fabric Grade Number/Cover Number
4. Arm Fabric Grade Number/Cover Number
5. Power Grommet
6. Paint (when applicable)
7. Wood Leg Finish (when applicable)

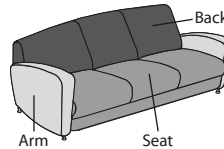

Contrasting Fabric

Three Seat Lounge with Tablet - Slim

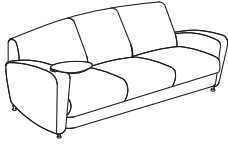

Metal Legs

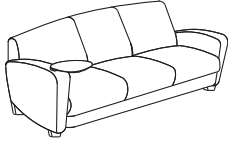

Wood Legs

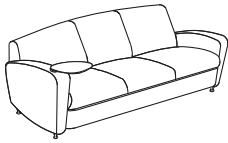

Removable Seat Cushion

Model No.

Grade / List Price

		1	2/COM	3/COL	4	6	7	L7	L8
N32SMMMR	Metal Legs, Tablet Right Arm	\$ 2994	3199	3297	3439	3884	4249	6002	6563
N32SMMML	Metal Legs, Tablet Left Arm	2994	3199	3297	3439	3884	4249	6002	6563
N32SMMMB	Metal Legs, Tablet Both Arms	3366	3571	3669	3811	4256	4621	6374	6935
N32SMMWR	Wood Legs, Tablet Right Arm	3111	3316	3414	3556	4001	4366	6119	6680
N32SMMWL	Wood Legs, Tablet Left Arm	3111	3316	3414	3556	4001	4366	6119	6680
N32SMMWB	Wood Legs, Tablet Both Arms	3484	3689	3787	3929	4374	4739	6492	7053
N32SMMRMS	Metal Legs, Tablet Right Arm, Removable Seat Cushion	3082	3305	3412	3567	4052	4450	6361	6972
N32SMMMLS	Metal Legs, Tablet Left Arm, Removable Seat Cushion	3082	3305	3412	3567	4052	4450	6361	6972
N32SMMBBS	Metal Legs, Tablet Both Arms, Removable Seat Cushion	3455	3678	3785	3940	4425	4823	6734	7345
N32SMMWRS	Wood Legs, Tablet Right Arm, Removable Seat Cushion	3198	3421	3528	3683	4168	4566	6477	7088
N32SMMWLS	Wood Legs, Tablet Left Arm, Removable Seat Cushion	3198	3421	3528	3683	4168	4566	6477	7088
N32SMMWBS	Wood Legs, Tablet Both Arms, Removable Seat Cushion	3571	3794	3901	4056	4541	4939	6850	7461

Dimensions

Width	75½	Arm Height	27	Seat Width	66¼	Weight	151
Depth	31	Seat Height	19			Cubic Ft.	69.4
Height	33	Seat Depth	21¼			Weight with Tablet Both Arms	163

- Contrasting fabric option – specify X (i.e., N32SMMMRX). For list pricing, use your electronic specification tool or contact customer service
- Tablet available in black thermofoil or veneer
- Veneer tablet available in all wood finishes and Cinder

To Order Contrasting Fabric, Specify:

1. Model Number plus “X”
2. Back Fabric Grade Number/Cover Number
3. Seat Fabric Grade Number/Cover Number
4. Arm Fabric Grade Number/Cover Number
5. Power Grommet
6. Tablet and Finish (when applicable)
7. Paint (when applicable)
8. Wood Leg Finish (when applicable)

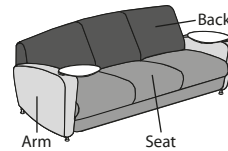

Contrasting Fabric

To Order, Specify:

1. Model Number
2. Fabric Grade Number
3. Cover Number
4. Power Grommet
5. Paint (when applicable)
6. Wood Leg Finish (when applicable)

• See page 331 for Reno options

**One Seat Lounge
Wood Arms - Slim**

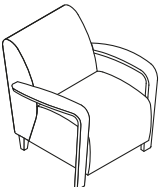

Wood Arms

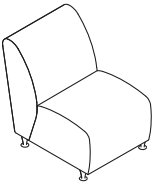

Armless - Metal Legs

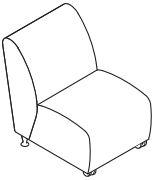

Armless - Metal Legs, Mobile

Model No.	Grade / List Price							
	1	2/COM	3/COL	4	6	7	L7	L8
N32STAAW	\$ 2223	2287	2318	2363	2503	2618	3169	3346
N32SMAAM Armless - Metal Legs	1466	1530	1561	1606	1746	1861	2412	2589
N32SMAAW Armless - Wood Legs	1583	1647	1678	1723	1863	1978	2529	2706
N32SMBBM Armless - Metal Legs, Mobile	1614	1678	1709	1754	1894	2009	2560	2737
N32SMBBW Armless - Wood Legs, Mobile	1731	1795	1826	1871	2011	2126	2677	2854

Dimensions

Width	29	Seat Height	19	Arm Height	27	Armless Weight	44
Armless Width	23	Seat Depth	21¼			Arm Weight	63
Depth	31	Seat Width	22½			Armless Cubic Ft.	28.0
Height	33					Arm Cubic Ft.	32.0

• Contrasting fabric option - specify X (i.e., N32STAAWX). For list pricing, use your electronic specification tool or contact customer service

To Order Contrasting Fabric, Specify:

1. Model Number plus "X"
2. Back Fabric Grade Number/Cover Number
3. Seat Fabric Grade Number/Cover Number
4. Power Grommet
5. Paint (when applicable)
6. Finish Designator (when applicable)
7. Glides

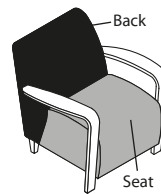

Contrasting Upholstery

**2½ Seat Lounge
Wood Arms - Slim**

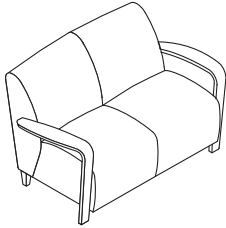

Wood Arms

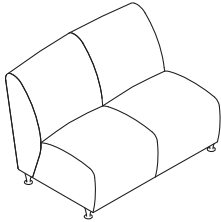

Armless - Metal Legs

**Model
No.**

Grade / List Price

		1	2/COM	3/COL	4	6	7	L7	L8
N32STHHW		\$ 2747	2899	2971	3077	3407	3678	4978	5394
N32SMHHM	Armless - Metal Legs	1990	2142	2214	2320	2650	2921	4221	4637
N32SMHHW	Armless - Wood Legs	2107	2259	2331	2437	2767	3038	4338	4754

Dimensions

Width	62	Seat Height	19	Arm Height	27	Armless Weight	87
Armless Width	56	Seat Depth	21¼			Arm Weight	100
Depth	31	Seat Width	55½			Armless Cubic Ft.	49.7
Height	33					Arm Cubic Ft.	56.1

• Contrasting fabric option - specify X (i.e., N32THWX). For list pricing, use your electronic specification tool or contact customer service

**Three Seat Lounge
Wood Arms - Slim**

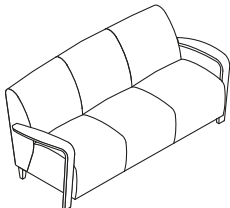

Wood Arms

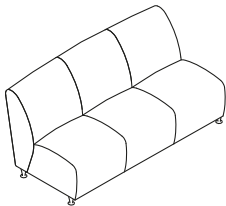

Armless - Metal Legs

		1	2/COM	3/COL	4	6	7	L7	L8
N32STLLW		\$ 3269	3400	3463	3554	3839	4073	5196	5555
N32SMLLM	Armless - Metal Legs	2513	2644	2707	2798	3083	3317	4440	4799
N32SMLLW	Armless - Wood Legs	2630	2761	2824	2915	3200	3434	4557	4916

Dimensions

Width	73	Seat Height	19	Arm Height	27	Armless Weight	106
Armless Width	66½	Seat Depth	21¼			Arm Weight	121
Depth	31	Seat Width	66½			Armless Cubic Ft.	56.1
Height	33					Arm Cubic Ft.	69.4

• Contrasting fabric option - specify X (i.e., N32TLLWX). For list pricing, use your electronic specification tool or contact customer service

To Order Contrasting Fabric, Specify:

1. Model Number plus "X"
2. Back Fabric Grade Number/Cover Number
3. Seat Fabric Grade Number/Cover Number
4. Power Grommet
5. Paint (when applicable)
6. Wood Leg Finish (when applicable)
7. Glides

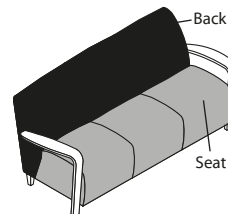

Contrasting Upholstery

Personal Pull-up Table



10N1622RTPUW	Wood	\$ 955
10N1622RTPUL	Laminate	955

Dimensions

Width	22	Weight	32
Depth	13¾	Cubic Ft.	9.25
Height	28½		

- 50 lb. weight limit
- Specify metal finish (462) Cinder, (501) Platinum Metallic, or (503) Satin Nickel Metallic
- Specify laminate or wood finish; **Laminates** (NM) Natural, (HN2) Honey 2, (CL) Caramel, (TF) Truffle, (AC2) Autumn 2, (MC) Amber, (CW) Cordovan, (DW) Judicial, (MH) Mocha, (405) Designer White, (462) Cinder, (791) Palisander, (792) Sable, or (793) Acorn; **Wood Finishes** (NM) Natural, (HN) Honey, (CL) Caramel, (TF) Truffle, (AC) Autumn, (MC) Amber, (CW) Cordovan, (DW) Judicial, (MH) Mocha, (405) Designer White, (462) Cinder, (792) Sable, or (793) Acorn

To Order Seating, Specify:

1. Model Number
2. Fabric Grade Number
3. Cover Number
4. Paint (when applicable)
5. Wood Leg Finish (when applicable)

To Order Tables, Specify:

1. Model Number
2. Surface Grommet
3. Side Grommet (when applicable)
4. Wood/Laminate Finish
5. Paint (when applicable)
6. Finish
7. Glides

• See page 331 for Reno options

One Seat Bench

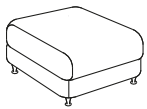

Metal Legs



Wood Legs

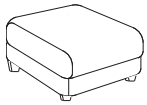

Mobile

Model No.

Grade / List Price

		1	2/COM	3/COL	4	6	7	L7	L8
N32KKM	Metal Legs	\$ 616	647	662	684	751	806	1072	1157
N32KKW	Wood Legs	734	765	780	802	869	924	1190	1275
N32KKC	Mobile	808	839	854	876	943	998	1264	1349

Dimensions

Width	24	Weight	28
Depth	24	Cubic Ft.	13.5
Height	17½		

2½ Seat Bench

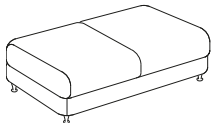

Metal Legs



Wood Legs

		1	2/COM	3/COL	4	6	7	L7	L8
N32HKM	Metal Legs	\$ 1353	1431	1469	1523	1693	1832	2502	2716
N32HKW	Wood Legs	1472	1550	1588	1642	1812	1951	2621	2835

Dimensions

Width	65	Weight	57
Depth	24	Cubic Ft.	16.9
Height	17½		

Three Seat Bench

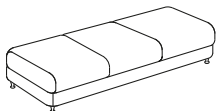

Metal Legs

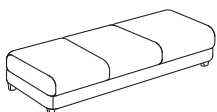

Wood Legs

		1	2/COM	3/COL	4	6	7	L7	L8
N32LKM	Metal Legs	\$ 1600	1674	1709	1760	1920	2051	2682	2883
N32LKW	Wood Legs	1718	1792	1827	1878	2038	2169	2800	3001

Dimensions

Width	75½	Weight	68
Depth	24	Cubic Ft.	17.3
Height	17½		

End Table

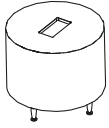
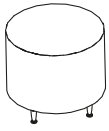

Optional Surface Grommet Location

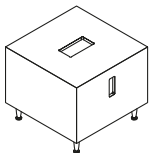
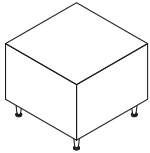

Optional Surface and Side Grommet Locations

Model No.

List Price

Round

N32T24ENW	Wood	\$ 1311
N32T24ENL	Laminate	1104

Dimensions (Round Models)

Diameter	24	Weight	35
Height	20 ⁵ / ₁₆	Cubic Ft.	11.0

- Side grommet not available on round models
- Optional surface grommet cutout available in G12, G17, and G23 cutout (+\$25 list)

Square

N32T2424ENW	Wood	\$ 1311
N32T2424ENL	Laminate	1104

Dimensions (Square Models)

Width	24	Weight	55
Depth	24	Cubic Ft.	12.6
Height	20 ⁵ / ₁₆		

- Optional surface grommet cutout available in G12, G17, and G23 cutout (+\$25 list)
- Optional side grommet cutout on square table available in G23 cutout (+\$25 list)
- Some assembly required; feet are field installed
- Power grommet sold separately; reference pages 463-464 for pricing and details
- Optional glass and solid surface kits available; reference page 430 in the Tables Price List

Magazine Table

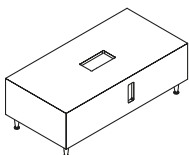
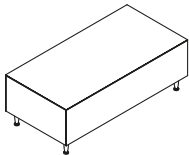

Optional Surface and Side Grommet Locations

N32T2448MGW	Wood	\$ 1405
N32T2448MGL	Laminate	1202

Dimensions

Width	48	Weight	77
Depth	24	Cubic Ft.	19.1
Height	16 ⁵ / ₁₆		

- Optional surface grommet cutout available in G12, G17, and G23 cutout (+\$25 list)
- Optional side grommet cutout available in G23 cutout (+\$25 list)
- Some assembly required; feet are field installed
- Power grommet sold separately; reference pages 463-464 for pricing and details
- Optional glass and solid surface kits available; reference page 430 in the Tables Price List

To Order, Specify:

1. Model Number
2. Surface Grommet
3. Side Grommet (when applicable)
4. Wood/Laminate Finish
5. Paint (when applicable)
6. Finish
7. Glides

• See page 331 for Reno options

Coffee Table

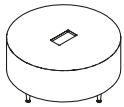
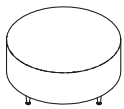

Optional Surface Grommet Location

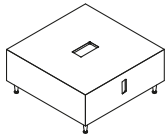
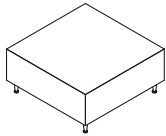

Optional Surface and Side Grommet Locations

Model No. **List Price**

Round

N32T36MGW	Wood	\$ 1461
N32T36MGL	Laminate	1261

Dimensions (Round Models)

Diameter	36 ¹ / ₁₆	Weight	55
Height	16 ¹ / ₁₆	Cubic Ft.	18.6

- Side grommet not available on round models
- Optional surface grommet cutout available in G12, G17, and G23 cutout (+\$25 list)

Square

N32T3636MGW	Wood	\$ 1461
N32T3636MGL	Laminate	1261

- Optional surface grommet cutout available in G12, G17, and G23 cutout
- Optional side grommet cutout available in G23 cutout

Dimensions (Square Models)

Width	36	Weight	65
Depth	36	Cubic Ft.	15
Height	16 ¹ / ₁₆		

- Some assembly required; feet are field installed
- Side grommet not available on round models
- Power grommet sold separately; reference pages 463-464 for pricing and details
- Optional glass and solid surface kits available; reference page 430 in the Tables Price List

Respect®

Respect

RESPECT PRODUCT SPECIFICATIONS

75 Series

FRAME CONSTRUCTION

Guest Model

- Frame constructed of exterior beech with joints double doweled and glued for maximum joint stability
- Features a metal seat understructure for added strength

SEAT AND BACK CONSTRUCTION

High and Mid Back Models

- 2½" of high grade polyurethane foam covers seat
- 9-ply inner, one piece molded plywood shell forms seat and back
- High back model consists of 1½" of high grade polyurethane foam on the lower back and 2½" on the upper back
- Mid back model consists of 1½" of high grade polyurethane foam on the back

Guest Model

- 2" of high grade polyurethane foam covers a solid plywood seat panel
- 1" of high grade polyurethane foam covers a solid plywood back panel

CONTROL MECHANISM/LIFT

- The standard knee tilt mechanism features a heavy-duty adjustment tension spring for a variety of body sizes and minimal rise of front seat edge. This allows the user's feet to remain planted when chair is in reclining position
- The combination gas lift/tilt lock lever allows dual function with simple in/out movement for lockout and up/down movement for height adjustment

BASE AND CASTERS

- Wood base features a standard five prong, rigid steel understructure to ensure long life
- Black and powder coated Satin Nickel Metallic bases feature reinforced nylon
- Black, hard double wheel casters, which work on multiple surfaces, are standard
- Black, soft double wheel casters are available for use on hard floors; upcharge applies to this option
- All National bases are tested to BIFMA standards using 2500 lb. force

ARMS

- Arms constructed of reinforced nylon available in black or powder coated Satin Nickel Metallic finish
- Arms are attached to seat and back with screws
- Arm pads are soft black polyurethane

UPHOLSTERY

- Gathering may result in upholstery due to the pillow back design

FINISH

- Wood models feature a catalyzed top coat that resists denting, peeling, and reactions to chemicals
- Can be cleaned with a damp cloth
- When specifying Brighton and Natural finish, variation in color is acceptable due to the nature of beech wood characteristics
- Features our silver ion antimicrobial finish which inhibits the growth of bacteria and microbes

WOOD SPECIES

- Beech

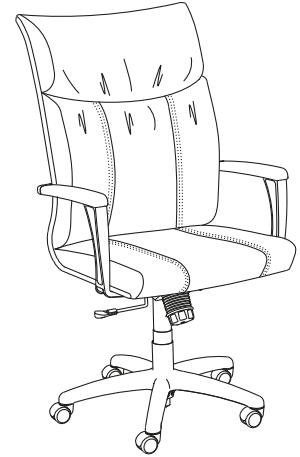

All Respect models may be ordered to meet TB133 fire code.

To order seating to meet the TB133 fire code, specify an "F" at the end of the model number (Ex: N75BACF).

Reference pages 465-493 for TB133 Fabric Matrix and pricing.

Please consult customer service for applicable Arc-Com, COM, Maharam, Momentum, Stinson or Ultrafabrics fabric.



For comprehensive sustainability information that includes LEED® point contribution, visit NationalOfficeFurniture.ecoScorecard.com.

FABRICS

- Grade 1 American Graffiti
- Cali
- Plush
- Ridge
- Speedway
- Stardust
- Grade 2 Cathedral
- COM
- Orbit
- Pixie
- Sedona
- Shenanigans
- Spectrum
- Strand
- Tranquility
- Twilight

- Grade 3 Boardwalk
- COL
- Jacks
- Pop Rocks
- Grade 4 Big City
- Bumble
- Connect Four
- Echo
- Silvertex
- Grade 6 Essence/Ultraleather
- Flock
- Scribe

- Grade 7 Brisa
- Brisa Distressed
- Promessa
- Silica
- Grade L7 Davenport
- Grade L8 Showcase

FINISHES

- IM Brighton
- NM Natural
- HN Honey
- CL Caramel
- TF Truffle
- AC Autumn
- MC Amber
- CW Cordovan
- DW Judicial
- MH Mocha
- 405 Designer White
- 462 Cinder
- 792 Sable
- 793 Acorn

CASTERS

- For Wood Base**
- C3 Hard (standard)
- C4 Soft (add \$24 list)
- For Plastic Base**
- C15 Hard (standard)
- C2 Soft (add \$24 list)

Respect

To You In
10 DAYS
...or Less

Shaded model numbers are available on our "To You in 10 Days or Less" Quick Delivery program and will be delivered within 10 days.

To Order, Specify:

1. Model Number
2. Fabric Grade Number
3. Cover Number
4. Finish Designator
5. Casters

• See page 357 for Respect options

High Back Plastic Base



All Covers

Model No.

Grade / List Price

Quick Delivery Model: QN75BAC

		1	2/COM	3/COL	4	6	7	L7	L8
N75BAC	Black Arms/Black Base	\$ 935	988	1013	1050	1165	1259	1712	1857
N75SAC	Satin Nickel Metallic Arms/ Satin Nickel Metallic Base	1085	1138	1163	1200	1315	1409	1862	2007
N75SSC	Satin Nickel Metallic Arms/ Black Base	1012	1065	1090	1127	1242	1336	1789	1934

Dimensions

Width	26½	Arm Height	26-31¼	Seat Width	22¼	Weight	40
Depth	27¾	Seat Height	16½-21¾			Cubic Ft.	20.4
Height	43¼-48½	Seat Depth	17½				

Mid Back Plastic Base

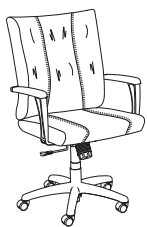

Leathers & Vinyls

Quick Delivery Model: QN75BCC

		1	2/COM	3/COL	4	6	7	L7	L8
N75BCC	Black Arms/Black Base	\$ 908	959	983	1018	1128	1218	1652	1790
N75SCC	Satin Nickel Metallic Arms/ Satin Nickel Metallic Base	1057	1108	1132	1167	1277	1367	1801	1939
N75SPC	Satin Nickel Metallic Arms/ Black Base	986	1037	1061	1096	1206	1296	1730	1868

Dimensions

Width	26½	Arm Height	26½-31½	Seat Width	22¼	Weight	39
Depth	26¼	Seat Height	17¼-22¾			Cubic Ft.	19.3
Height	39½-44¾	Seat Depth	16¾				

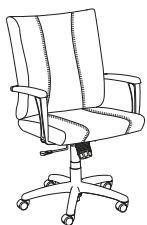

All Fabrics

**High Back
Wood Base**



All Covers

Model No.		Grade / List Price							
		1	2/COM	3/COL	4	6	7	L7	L8
N75BBC	Black Arms/Wood Base	\$ 1114	1167	1192	1229	1344	1438	1891	2036
N755BC	Satin Nickel Metallic Arms/Wood Base	1193	1246	1271	1308	1423	1517	1970	2115
Dimensions									
Width	26½	Arm Height	26-31¼	Seat Width	22¼	Weight	46		
Depth	27¾	Seat Height	16½-21¾			Cubic Ft.	20.4		
Height	43¼-48½	Seat Depth	17½						

**Mid Back
Wood Base**



Leathers & Vinyls

Model No.		Grade / List Price							
		1	2/COM	3/COL	4	6	7	L7	L8
N75BDC	Black Arms/Wood Base	\$ 1089	1140	1164	1199	1309	1399	1833	1971
N755DC	Satin Nickel Metallic Arms/Wood Base	1165	1216	1240	1275	1385	1475	1909	2047
Dimensions									
Width	26½	Arm Height	26½-31½	Seat Width	22¼	Weight	45		
Depth	26¼	Seat Height	17¼-22¾			Cubic Ft.	19.3		
Height	39½-44¾	Seat Depth	16¾						



All Fabrics

Guest

Quick Delivery Model: QN75WS

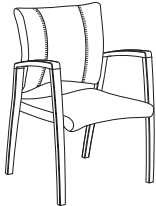

All Covers

Model No.		Grade / List Price							
		1	2/COM	3/COL	4	6	7	L7	L8
N75WS	Wood Frame	\$ 735	765	779	800	865	918	1174	1256
Dimensions									
Width	24¾	Arm Height	27¼	Seat Width	20½	Weight	19		
Depth	22¾	Seat Height	18			Cubic Ft.	15.3		
Height	34¾	Seat Depth	16½						

Respect

Result®

Result

RESULT PRODUCT SPECIFICATIONS

80 Series

SEAT CONSTRUCTION

- 3" of high grade polyurethane foam covers a contour molded plywood seat panel for support and comfort

BACK CONSTRUCTION

- 2½" of high grade polyurethane foam covers a contour molded plywood back panel with 3½" of foam in the lumbar region

ARMS

- Arms are molded black polyurethane

CONTROL MECHANISM/LIFT

- Knee tilt control features adjustable tension and upright back lock feature
- The standard pneumatic gas cylinder lift allows the seat to raise and lower 3½"

BASE AND CASTERS

- Nylon five-prong base features black glass filled nylon for beauty and long life
- Standard double wheel casters work on multiple surfaces

UPHOLSTERY

- Black leather/faux leather upholstery features leather on all contact surfaces and faux leather on outer seat and back shell

ASSEMBLY

- Product is shipped ready-to-assemble
- Three sub-assemblies join with no tools required



UPHOLSTERY

Black Leather/Faux Leather Only

Result

To You In
10 DAYS
...or Less

Shaded model numbers are available on our "To You in 10 Days or Less" Quick Delivery program and will be delivered within 10 days.

To Order, Specify:

1. Model Number
- See page 363 for Result options

High Back



Model No.

List Price

Leather/Faux Leather

N80AA Knee Tilt \$ **695**

Dimensions

Width	26½	Seat Width	20¾	Arm Height	25-29	Weight	39
Depth	26¼	Seat Depth	17¾	Kneespace	20½	Cubic Ft.	13.81
Height	43¼-47	Seat Height	16¾-19¾				

- Features a standard Quick Delivery lead time
- Some assembly required

Mid Back



Leather/Faux Leather

N80BB Knee Tilt \$ **628**

Dimensions

Width	26½	Seat Width	20¾	Arm Height	25-29	Weight	37
Depth	26¼	Seat Depth	17¾	Kneespace	20½	Cubic Ft.	12.12
Height	38¼-41½	Seat Height	16¾-19¾				

- Features a standard Quick Delivery lead time
- Some assembly required

SwiftTM

Swift

SWIFT PRODUCT SPECIFICATIONS

LOUNGE

FRAME CONSTRUCTION

- Interior frame is constructed of plywood with tenon joints that are glued and screwed for maximum joint stability
- Exterior base frame is constructed with hard maple and aluminum extrusions
- Each joint is securely glued for maximum joint stability

SEAT CONSTRUCTION

- 4" of high grade polyurethane foam covers a plywood seat panel with high tension strip webbing for comfort

BACK CONSTRUCTION

- 4½" of high grade custom shaped polyurethane foam stretched over web sheet and attached to frame

ARM CONSTRUCTION

- ½" of high grade polyurethane foam covers a plywood constructed arm frame

UPHOLSTERY DETAIL

- Contrasting fabric available on all models

LEGS

- Extruded aluminum legs with nylon leveling glides

MOBILE UNIT CASTERS

- Black, double wheel, roll control casters are standard and work on all floors

TABLET ARM

- ¾" thick black thermofoil with MDF core or ¾" thick maple
- Attached with ¼" steel base plate and screws that mounts over ¾" metal insert rod and fits into structure of arm
- Allows for 360° swivel and writing surface of 21" W x 13½" D

FINISH

- Base features a catalyzed top coat that resists denting, peeling and reactions to chemicals
- Features our silver ion antimicrobial finish which inhibits the growth of bacteria and microbes

WOOD SPECIES

- Hard maple

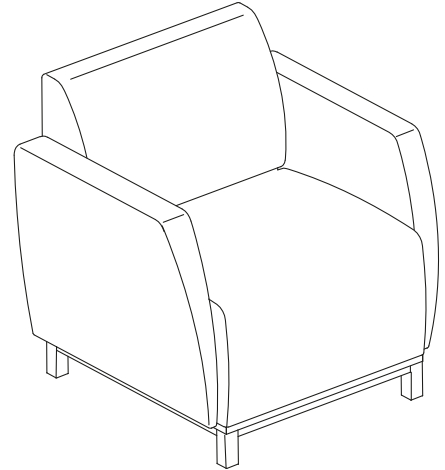

TABLES

FRAME CONSTRUCTION

- Grade A slipmatched cherry or maple veneer or laminate with mitered corners and extruded aluminum legs with rails
- Veneer tables feature National's IntegraClear® environmentally-friendly UV finish
- Veneer tables feature matte/satin sheen

POWER AND DATA GROMMET

- Available in the 30°, 45°, 90° and small end tables
- Three power grommets available; specify cutout option and order electrical grommet model separately. See pages 463-464 for details and pricing
- \$25 list upcharge per cutout location
- Power grommet not available on coffee or console tables

All Swift models may be ordered to meet TB133 fire code.

To order seating to meet the TB133 fire code, specify an "F" at the end of the model number (Ex: N95MAF).

Reference pages 465-493 for TB133 Fabric Matrix and pricing.

Please consult customer service for applicable Arc-Com, COM, Maharam, Momentum, Stinson or Ultrafabrics fabric.



For comprehensive sustainability information that includes LEED® point contribution, visit NationalOfficeFurniture.ecoScorecard.com.

FABRICS

Grade 1	American Graffiti
	Cali
	Plush
	Ridge
	Speedway
Grade 2	Stardust
	Cathedral
	COM
	Orbit
	Pixie
	Sedona
	Shenanigans
	Spectrum
Grade 3	Strand
	Tranquility
	Twilight

Grade 3	Boardwalk
	COL
	Jacks
Grade 4	Pop Rocks
	Big City
	Bumble
	Connect Four
	Echo
Grade 6	Silvertex
	Essence/Ultraleather
	Flock
	Scribe

Grade 7	Brisa
	Brisa Distressed
	Promessa
	Silica
Grade L7	Davenport
Grade L8	Showcase

**TABLES
SURFACE GROMMETS/CUTOUTS**

(\$25 list upcharge per location)

CUT-G12	G12 Cutout
CUT-G17	G17 Cutout
CUT-G23	G23 Cutout
X	No Grommet

**TABLES
SIDE GROMMETS/CUTOUTS**

(\$25 list upcharge per location)

CUT-G23C	Power Grommet
X	No Grommet

Reference pages 463-464 for pricing and details

TABLET ARM

T	Thermofoil, Black
W	Wood

FINISHES

IM	Brighton	CW	Cordovan
NM	Natural	DW	Judicial
HN	Honey	MH	Mocha
CL	Caramel	*405	Designer White
TF	Truffle	*462	Cinder
AC	Autumn	*792	Sable
MC	Amber	*793	Acorn

*Not available on tables

LAMINATES

IM	Brighton	405	Designer White
NM	Natural	417	Mojave
HN2	Honey 2	418	Mouse
CL	Caramel	419	Wallaby
TF	Truffle	425	Shadow
AC2	Autumn 2	440	Cloud
MC	Amber	461	Graphite
CW	Cordovan	462	Cinder
DW	Judicial	478	Platinum Grey
MH	Mocha	488	Frosty White
*791	Palisander	491	Designer White Linear
792	Sable	492	Cinder Linear
793	Acorn		

*791 Palisander coordinates with (NM) Natural, (HN) Honey and (MH) Mocha finishes

FRAME COLORS

462	Cinder
497	Polished Aluminum
501	Platinum Metallic
503	Satin Nickel Metallic

To Order, Specify:

1. Model Number
2. Fabric Grade Number
3. Cover Number
4. Tablet (when applicable)
5. Finish Designator
6. Frame Color

• See page 367 for Swift options

Armless One Seat Lounge

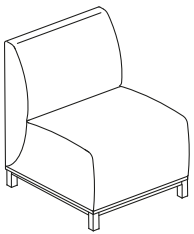

Armless

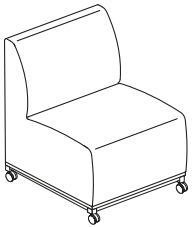

Armless - Mobile

Model No.

Grade / List Price

		1	2/COM	3/COL	4	6	7	L7	L8
N95MA	Armless	\$ 1686	1757	1791	1841	1996	2123	2734	2929
N95MAC	Armless - Mobile	1834	1905	1939	1989	2144	2271	2882	3077

Dimensions

Width	26½	Seat Height	19¼	Seat Depth	21¾	Weight	49
Depth	30	Seat Width	26½	Back Height	32½	Cubic Ft.	26.3
Height	32½			Back Width	26½		

- Contrasting fabric option – specify X (i.e., N95MAX). For list pricing, use your electronic specification tool or contact customer service

To Order Contrasting Fabric, Specify:

1. Model Number plus "X"
2. Back Fabric Grade Number/Cover Number
3. Extreme Fabric Grade Number/Cover Number
4. Back Accent Fabric Grade Number/Cover Number
5. Seat Fabric Grade Number/Cover Number
6. Seat Accent Fabric Grade Number/Cover Number
7. Finish Designator
8. Frame Color

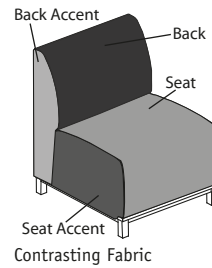

Contrasting Fabric

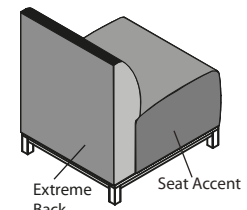

Contrasting Fabric Back View

One Seat Lounge

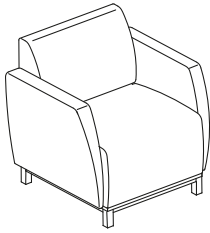

Arms

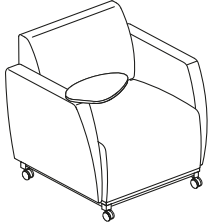

Tablet Right Arm - Mobile

Model No.

Grade / List Price

		1	2/COM	3/COL	4	6	7	L7	L8
N95AA	Arms	\$ 2195	2326	2389	2480	2765	2999	4122	4481
N95AAR	Tablet Right Arm	2416	2547	2610	2701	2986	3220	4343	4702
N95AAL	Tablet Left Arm	2416	2547	2610	2701	2986	3220	4343	4702
N95AAC	Arms - Mobile	2343	2474	2537	2628	2913	3147	4270	4629
N95AARC	Tablet Right Arm - Mobile	2566	2697	2760	2851	3136	3370	4493	4852
N95AALC	Tablet Left Arm - Mobile	2566	2697	2760	2851	3136	3370	4493	4852

Dimensions

Width	32	Arm Height	27¼	Seat Depth	21¾	Weight	78
Depth	30	Seat Height	19¼	Back Height	32½	Cubic Ft.	26.3
Height	32½	Seat Width	26½	Back Width	26½		

- Contrasting fabric option – specify X (i.e., N95AARX). For list pricing, use your electronic specification tool or contact customer service
- Tablet available in black thermofoil or veneer
- Veneer tablet arm available in all wood finishes and Cinder

To Order Contrasting Fabric, Specify:

1. Model Number plus "X"
2. Back Fabric Grade Number/Cover Number
3. Extreme Fabric Grade Number/Cover Number
4. Back Accent Fabric Grade Number/Cover Number
5. Seat Fabric Grade Number/Cover Number
6. Seat Accent Fabric Grade Number/Cover Number
7. Arm Fabric Grade Number/Cover Number
8. Tablet (when applicable)
9. Finish Designator
10. Frame Color

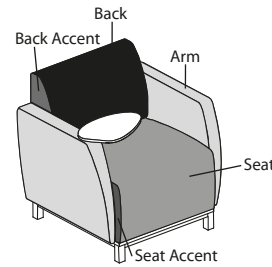

Contrasting Fabric
Tablet Right Arm

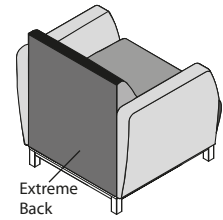

Contrasting Fabric Back View

To Order, Specify:

1. Model Number
2. Fabric Grade Number
3. Cover Number
4. Tablet (when applicable)
5. Finish Designator
6. Frame Color

• See page 367 for Swift options

One Seat Lounge

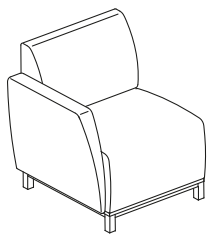

Right Arm

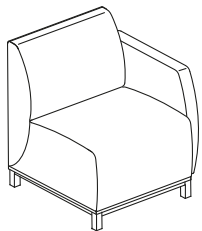

Left Arm

Model No.

Grade / List Price

		1	2/COM	3/COL	4	6	7	L7	L8
N95MAR	Right Arm	\$ 1920	2021	2070	2140	2360	2540	3407	3684
N95MART	Tablet Right Arm	2184	2285	2334	2404	2624	2804	3671	3948
N95MAL	Left Arm	1920	2021	2070	2140	2360	2540	3407	3684
N95MALT	Tablet Left Arm	2184	2285	2334	2404	2624	2804	3671	3948

Dimensions

Width	29½	Arm Height	27¼	Seat Depth	21¾	Weight	67
Depth	30	Seat Height	19¼	Back Height	32½	Cubic Ft.	26.3
Height	32½	Seat Width	26½	Back Width	26½		

- Contrasting fabric option – specify X (i.e., N95MALX). For list pricing, use your electronic specification tool or contact customer service
- Tablet available in black thermofoil or veneer
- Veneer tablet arm available in all wood finishes and Cinder

To Order Contrasting Fabric, Specify:

1. Model Number plus "X"
2. Back Fabric Grade Number/Cover Number
3. Extreme Fabric Grade Number/Cover Number
4. Back Accent Fabric Grade Number/Cover Number
5. Seat Fabric Grade Number/Cover Number
6. Seat Accent Fabric Grade Number/Cover Number
7. Arm Fabric Grade Number/Cover Number
8. Tablet (when applicable)
9. Finish Designator
10. Frame Color

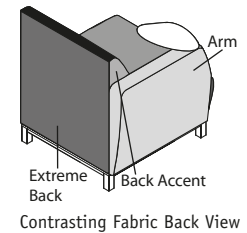
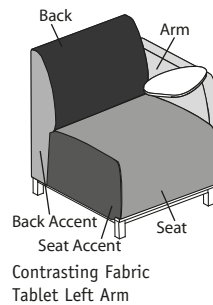

Armless Two Seat Lounge

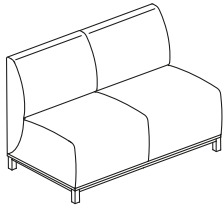

Model No.

Grade / List Price

		1	2/COM	3/COL	4	6	7	L7	L8
N95MB	Armless	\$ 2446	2556	2609	2686	2926	3123	4068	4371

Dimensions

Width	51½	Seat Height	19¼	Seat Depth	21¾	Weight	84
Depth	30	Seat Width	51½	Back Height	32½	Cubic Ft.	48.8
Height	32½			Back Width	51½		

- Contrasting fabric option – specify X (i.e., N95MBX). For list pricing, use your electronic specification tool or contact customer service

To Order Contrasting Fabric, Specify:

1. Model Number plus "X"
2. Back Fabric Grade Number/Cover Number
3. Extreme Fabric Grade Number/Cover Number
4. Back Accent Fabric Grade Number/Cover Number
5. Seat Fabric Grade Number/Cover Number
6. Seat Accent Fabric Grade Number/Cover Number
7. Finish Designator
8. Frame Color

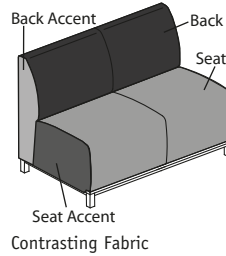

Contrasting Fabric

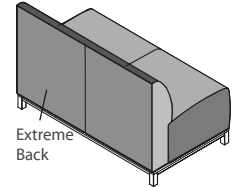

Contrasting Fabric Back View

To Order, Specify:

1. Model Number
2. Fabric Grade Number
3. Cover Number
4. Tablet (when applicable)
5. Finish Designator
6. Frame Color

• See page 367 for Swift options

Two Seat Lounge

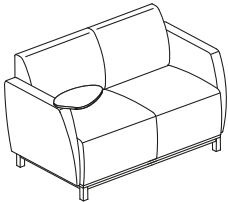
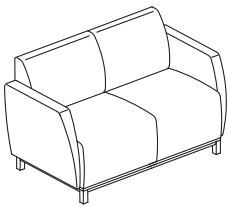

Tablet Right Arm

Model No.

Grade / List Price

		1	2/COM	3/COL	4	6	7	L7	L8
N95BB	Arms	\$ 2956	3106	3177	3281	3606	3873	5153	5563
N95BBR	Tablet Right Arm	3179	3329	3400	3504	3829	4096	5376	5786
N95BBL	Tablet Left Arm	3179	3329	3400	3504	3829	4096	5376	5786
N95BBB	Tablet Both Arms	3400	3550	3621	3725	4050	4317	5597	6007

Dimensions

Width	59¼	Arm Height	27¼	Seat Depth	21¾	Weight	120
Depth	30	Seat Height	19¼	Back Height	32½	Cubic Ft.	48.8
Height	32½	Seat Width	51½	Back Width	51½		

- Contrasting fabric option – specify X (i.e., N95BBRX). For list pricing, use your electronic specification tool or contact customer service
- Tablet available in black thermofoil or veneer
- Veneer tablet arm available in all wood finishes and Cinder

To Order Contrasting Fabric, Specify:

1. Model Number plus "X"
2. Back Fabric Grade Number/Cover Number
3. Extreme Fabric Grade Number/Cover Number
4. Back Accent Fabric Grade Number/Cover Number
5. Seat Fabric Grade Number/Cover Number
6. Seat Accent Fabric Grade Number/Cover Number
7. Arm Fabric Grade Number/Cover Number
8. Tablet (when applicable)
9. Finish Designator
10. Frame Color

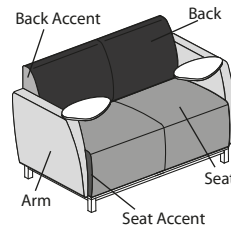

Contrasting Fabric
Tablet Both Arms

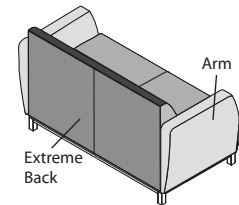

Contrasting Fabric Back View

Two Seat Lounge

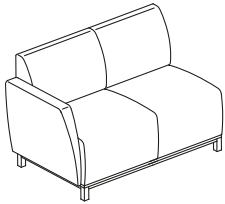

Right Arm

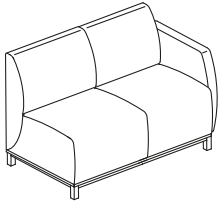

Left Arm

Model No.

Grade / List Price

		1	2/COM	3/COL	4	6	7	L7	L8
N95MBR	Right Arm	\$ 2681	2803	2861	2946	3211	3428	4472	4806
N95MBRT	Tablet Right Arm	2944	3066	3124	3209	3474	3691	4735	5069
N95MBL	Left Arm	2681	2803	2861	2946	3211	3428	4472	4806
N95MBLT	Tablet Left Arm	2944	3066	3124	3209	3474	3691	4735	5069

Dimensions

Width	55¾	Arm Height	27¼	Seat Depth	21¾	Weight	113
Depth	30	Seat Height	19¼	Back Height	32½	Cubic Ft.	48.8
Height	32½	Seat Width	51½	Back Width	51½		

- Contrasting fabric option – specify X (i.e., N95MBLX). For list pricing, use your electronic specification tool or contact customer service
- Tablet available in black thermofoil or veneer
- Veneer tablet arm available in all wood finishes and Cinder

To Order Contrasting Fabric, Specify:

1. Model Number plus "X"
2. Back Fabric Grade Number/Cover Number
3. Extreme Fabric Grade Number/Cover Number
4. Back Accent Fabric Grade Number/Cover Number
5. Seat Fabric Grade Number/Cover Number
6. Seat Accent Fabric Grade Number/Cover Number
7. Arm Fabric Grade Number/Cover Number
8. Tablet (when applicable)
9. Finish Designator
10. Frame Color

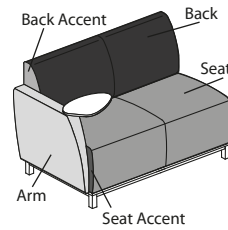

Contrasting Fabric Tablet Right Arm

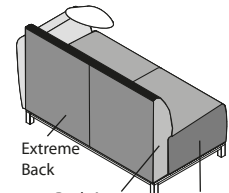

Contrasting Fabric Back View

To Order, Specify:

1. Model Number
2. Fabric Grade Number
3. Cover Number
4. Tablet (when applicable)
5. Finish Designator
6. Frame Color

• See page 367 for Swift options

Three Seat Lounge

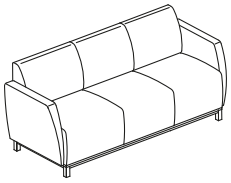
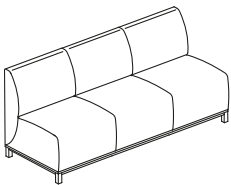

Model No.

Grade / List Price

		1	2/COM	3/COL	4	6	7	L7	L8
N95MC	Armless	\$ 3208	3362	3436	3543	3878	4153	5473	5895
N95CC	Arms	3716	3916	4012	4151	4586	4943	6657	7205

Dimensions

Width Armless	78	Arm Height	27¼	Seat Depth	21¾	Weight	141
Width	85	Seat Height	19¼	Back Height	32½	Cubic Ft.	72.2
Depth	30	Seat Width	79½	Back Width	79½		
Height	32½						

• Contrasting fabric option – specify X (i.e., N95CCX). For list pricing, use your electronic specification tool or contact customer service

To Order Contrasting Fabric, Specify:

1. Model Number plus “X”
2. Back Fabric Grade Number/Cover Number
3. Extreme Fabric Grade Number/Cover Number
4. Back Accent Fabric Grade Number/Cover Number
5. Seat Fabric Grade Number/Cover Number
6. Seat Accent Fabric Grade Number/Cover Number
7. Arm Fabric Grade Number/Cover Number
8. Finish Designator
9. Frame Color

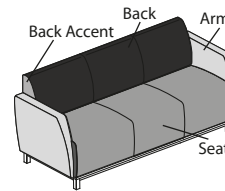

Contrasting Fabric

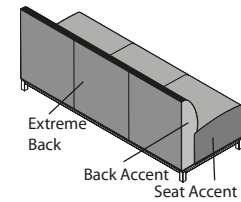

Contrasting Fabric Back View

Three Seat Lounge with Tablet

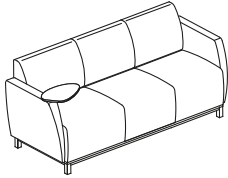

Tablet Right Arm

Model No.

Grade / List Price

		1	2/COM	3/COL	4	6	7	L7	L8
N95CCR	Tablet Right Arm	\$ 3939	4139	4235	4374	4809	5166	6880	7428
N95CCL	Tablet Left Arm	3939	4139	4235	4374	4809	5166	6880	7428
N95CCB	Tablet Both Arms	4161	4361	4457	4596	5031	5388	7102	7650

Dimensions

Width	85	Arm Height	27¼	Seat Depth	21¾	Weight	155
Depth	30	Seat Height	19¼	Back Height	32½	Cubic Ft.	72.2
Height	32½	Seat Width	79½	Back Width	79½		

- Contrasting fabric option – specify X (i.e., N95CCR^X). For list pricing, use your electronic specification tool or contact customer service
- Tablet available in black thermofoil or veneer
- Veneer tablet arm available in all wood finishes and Cinder

To Order Contrasting Fabric, Specify:

1. Model Number plus "X"
2. Back Fabric Grade Number/Cover Number
3. Extreme Fabric Grade Number/Cover Number
4. Back Accent Fabric Grade Number/Cover Number
5. Seat Fabric Grade Number/Cover Number
6. Seat Accent Fabric Grade Number/Cover Number
7. Arm Fabric Grade Number/Cover Number
8. Tablet (when applicable)
9. Finish Designator
10. Frame Color

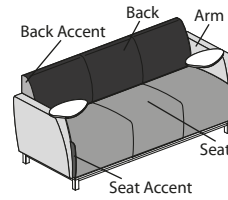

Contrasting Fabric
Tablet Both Arms

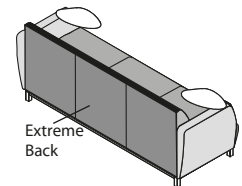

Contrasting Fabric Back View

To Order, Specify:

1. Model Number
2. Fabric Grade Number
3. Cover Number
4. Tablet (when applicable)
5. Finish Designator
6. Frame Color

• See page 367 for Swift options

Three Seat Lounge

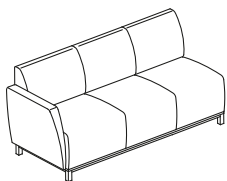

Right Arm

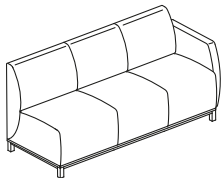

Left Arm

Model No.	Grade / List Price								
		1	2/COM	3/COL	4	6	7	L7	L8
N95MCR	Right Arm	\$ 3442	3612	3694	3812	4182	4485	5943	6409
N95MCR	Tablet Right Arm	3706	3876	3958	4076	4446	4749	6207	6673
N95MCL	Left Arm	3442	3612	3694	3812	4182	4485	5943	6409
N95MCL	Tablet Left Arm	3706	3876	3958	4076	4446	4749	6207	6673

Dimensions

Width	82¼	Arm Height	27¼	Seat Depth	21¾	Weight	148
Depth	30	Seat Height	19¼	Back Height	32½	Cubic Ft.	72.2
Height	32½	Seat Width	79½	Back Width	79½		

- Contrasting fabric option – specify X (i.e., N95MCLX). For list pricing, use your electronic specification tool or contact customer service
- Tablet available in black thermofoil or veneer
- Veneer tablet arm available in all wood finishes and Cinder

To Order Contrasting Fabric, Specify:

1. Model Number plus "X"
2. Back Fabric Grade Number/Cover Number
3. Extreme Fabric Grade Number/Cover Number
4. Back Accent Fabric Grade Number/Cover Number
5. Seat Fabric Grade Number/Cover Number
6. Seat Accent Fabric Grade Number/Cover Number
7. Arm Fabric Grade Number/Cover Number
8. Tablet (when applicable)
9. Finish Designator
10. Frame Color

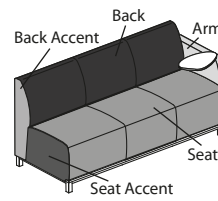

Contrasting Fabric Tablet Left Arm

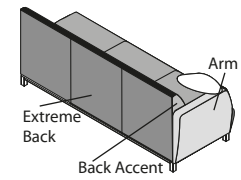

Contrasting Fabric Back View

Personal Pull-up Table



10N1622RTPUW	Wood	\$ 955
10N1622RTPUL	Laminate	955

Dimensions

Width	22	Weight	32
Depth	13¾	Cubic Ft.	9.25
Height	28½		

- 50 lb. weight limit
- Specify metal finish (462) Cinder, (501) Platinum Metallic, or (503) Satin Nickel Metallic
- Specify laminate or wood finish; **Laminates** (NM) Natural, (HN2) Honey 2, (CL) Caramel, (TF) Truffle, (AC2) Autumn 2, (MC) Amber, (CW) Cordovan, (DW) Judicial, (MH) Mocha, (405) Designer White, (462) Cinder, (791) Palisander, (792) Sable, or (793) Acorn; **Wood Finishes** (NM) Natural, (HN) Honey, (CL) Caramel, (TF) Truffle, (AC) Autumn, (MC) Amber, (CW) Cordovan, (DW) Judicial, (MH) Mocha, (405) Designer White, (462) Cinder, (792) Sable, or (793) Acorn

30° Corner Unit

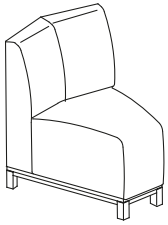

30° Inside Corner

Model No.

Grade / List Price

		1	2/COM	3/COL	4	6	7	L7	L8
N95MH	Inside Corner	\$ 1627	1687	1715	1757	1887	1994	2506	2670

Dimensions

Width	25¾	Seat Height	19¼				Weight	40
Depth	32						Cubic Ft.	31.9
Height	32½							

- Contrasting fabric option – specify X (i.e., N95MHX). For list pricing, use your electronic specification tool or contact customer service
- Stripes and plaids are not recommended as the fabrics may not align at the seams

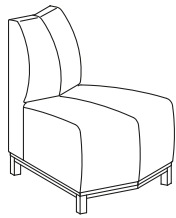

30° Outside Corner

		1	2/COM	3/COL	4	6	7	L7	L8
N95MHA	Outside Corner	\$ 1627	1682	1709	1747	1867	1965	2438	2589

Dimensions

Width	27	Seat Height	19¼				Weight	40
Depth	31						Cubic Ft.	31.9
Height	32½							

- Contrasting fabric option – specify X (i.e., N95MHAX). For list pricing, use your electronic specification tool or contact customer service
- Stripes and plaids are not recommended as the fabrics may not align at the seams

To Order Contrasting Fabric, Specify:

1. Model Number plus "X"
2. Back Fabric Grade Number/Cover Number
3. Extreme Fabric Grade Number/Cover Number
4. Back Accent Fabric Grade Number/Cover Number
5. Seat Fabric Grade Number/Cover Number
6. Seat Accent Fabric Grade Number/Cover Number
7. Finish Designator
8. Frame Color

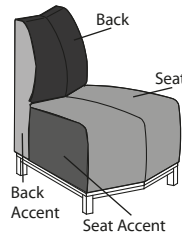

Contrasting Fabric

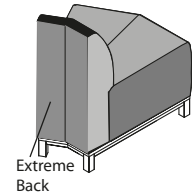

Contrasting Fabric Back View

To Order, Specify:

1. Model Number
2. Fabric Grade Number
3. Cover Number
4. Finish Designator
5. Frame Color

• See page 367 for Swift options

45° Inside Corner Unit

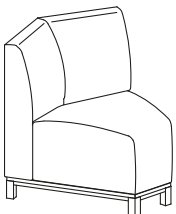

45° Inside Corner

Model No.	Grade / List Price								
		1	2/COM	3/COL	4	6	7	L7	L8
N95MJ	Inside Corner	\$ 1890	1961	1995	2045	2200	2327	2938	3133

Dimensions

Width	32½	Seat Height	19¼	Weight	45
Depth	32½			Cubic Ft.	31.9
Height	32½				

- Contrasting fabric option – specify X (i.e., N95MJX). For list pricing, use your electronic specification tool or contact customer service
- Stripes and plaids are not recommended as the fabrics may not align at the seams

To Order Contrasting Fabric, Specify:

1. Model Number plus “X”
2. Back Fabric Grade Number/Cover Number
3. Extreme Fabric Grade Number/Cover Number
4. Back Accent Fabric Grade Number/Cover Number
5. Seat Fabric Grade Number/Cover Number
6. Seat Accent Fabric Grade Number/Cover Number
7. Finish Designator
8. Frame Color

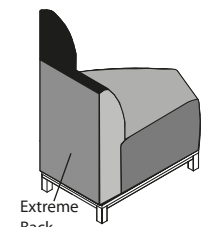
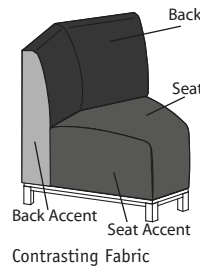

45° Outside Corner Unit

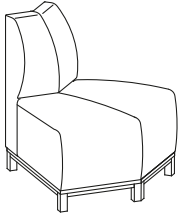

45° Outside Corner

Model No.

Grade / List Price

		1	2/COM	3/COL	4	6	7	L7	L8
N95MJA	Outside Corner	\$ 1890	1952	1982	2025	2160	2271	2803	2973

Dimensions

Width	33½	Seat Height	19¼				Weight	45
Depth	33½						Cubic Ft.	31.9
Height	32½							

- Contrasting fabric option – specify X (i.e., N95MJAX). For list pricing, use your electronic specification tool or contact customer service
- Stripes and plaids are not recommended as the fabrics may not align at the seams

90° Inside Corner Unit

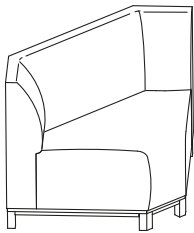

		1	2/COM	3/COL	4	6	7	L7	L8
N95MK	Inside Corner	\$ 2446	2545	2592	2661	2876	3052	3899	4170

Dimensions

Width	50½	Seat Height	19¼				Weight	56
Depth	30						Cubic Ft.	31.9
Height	32½							

- Contrasting fabric option – specify X (i.e., N95MKX). For list pricing, use your electronic specification tool or contact customer service
- Stripes and plaids are not recommended as the fabrics may not align at the seams

To Order Contrasting Fabric, Specify:

1. Model Number plus "X"
2. Back Fabric Grade Number/Cover Number
3. Extreme Fabric Grade Number/Cover Number
4. Back Accent Fabric Grade Number/Cover Number
5. Seat Fabric Grade Number/Cover Number
6. Seat Accent Fabric Grade Number/Cover Number
7. Finish Designator
8. Frame Color

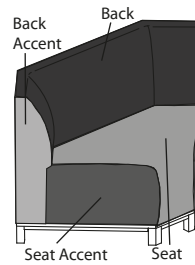

Contrasting Fabric

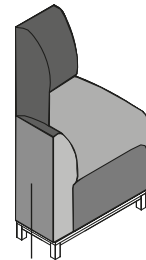

Extreme Back
Contrasting Fabric Back View

To Order, Specify:

1. Model Number
2. Fabric Grade Number
3. Cover Number
4. Finish Designator
5. Frame Color

• See page 367 for Swift options

90° Outside Corner Unit

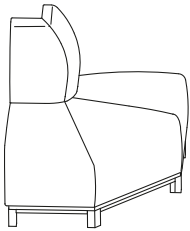

Model No.	Grade / List Price								
		1	2/COM	3/COL	4	6	7	L7	L8
N95MKA	Outside Corner	\$ 2446	2517	2551	2601	2756	2883	3494	3689

Dimensions

Width	48 ⁷ / ₈	Seat Height	19 ¹ / ₄	Weight	56
Depth	33 ³ / ₈			Cubic Ft.	36.9
Height	32 ¹ / ₂				

- Contrasting fabric option – specify X (i.e., N95MKAX). For list pricing, use your electronic specification tool or contact customer service
- Stripes and plaids are not recommended as the fabrics may not align at the seams

To Order Contrasting Fabric, Specify:

1. Model Number plus "X"
2. Back Fabric Grade Number/Cover Number
3. Extreme Fabric Grade Number/Cover Number
4. Back Accent Fabric Grade Number/Cover Number
5. Seat Fabric Grade Number/Cover Number
6. Seat Accent Fabric Grade Number/Cover Number
7. Finish Designator
8. Frame Color

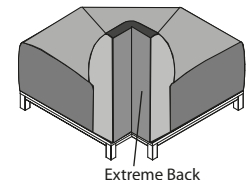
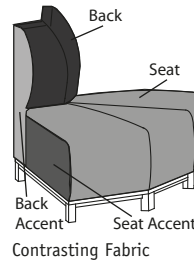

Contrasting Fabric Back View
90° Outside Corner

One Seat Bench

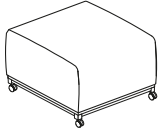
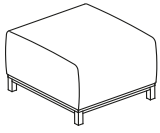

Mobile

Model No.

Grade / List Price

		1	2/COM	3/COL	4	6	7	L7	L8
N95DD	One Seat Bench	\$ 1306	1366	1394	1436	1566	1673	2185	2349
N95DDC	One Seat Bench - Mobile	1454	1514	1542	1584	1714	1821	2333	2497

Dimensions

Width	26¼							Weight	35
Depth	30							Cubic Ft.	16.7
Height	19¼								

- Contrasting fabric option – specify X (i.e., N95DDX). For list pricing, use your electronic specification tool or contact customer service
- Railroaded fabrics will require a seam on the front and back edges of bench

Two Seat Bench

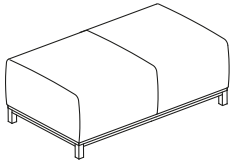

		1	2/COM	3/COL	4	6	7	L7	L8
N95EE	Two Seat Bench	\$ 1804	1882	1920	1974	2144	2283	2953	3167

Dimensions

Width	51½							Weight	65
Depth	30							Cubic Ft.	29.4
Height	19¼								

- Contrasting fabric option – specify X (i.e., N95EEEX). For list pricing, use your electronic specification tool or contact customer service
- Railroaded fabrics will require a seam on the front and back edges of bench

Three Seat Bench

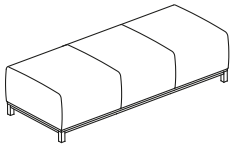

		1	2/COM	3/COL	4	6	7	L7	L8
N95GG	Three Seat Bench	\$ 2300	2436	2501	2595	2890	3132	4294	4666

Dimensions

Width	76							Weight	95
Depth	30							Cubic Ft.	44.8
Height	19¼								

- Contrasting fabric option – specify X (i.e., N95GGX). For list pricing, use your electronic specification tool or contact customer service
- Railroaded fabrics will require a seam on the front and back edges of bench

To Order Contrasting Fabric, Specify:

1. Model Number plus "X"
2. Seat Fabric Grade Number/Cover Number
3. Seat Accent Fabric Grade Number/Cover Number
4. Finish Designator
5. Frame Color

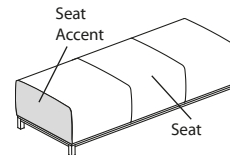

Contrasting Fabric

To Order, Specify:

1. Model Number
2. Surface Grommet
3. Side Grommet
4. Wood/Laminate Finish
5. Frame Color

• See page 367 for Swift options

30° Table

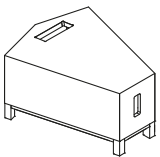
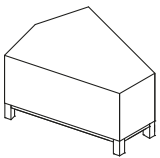

Optional Surface and Side Grommet Locations

Model No. **List Price**

N95KKW	Wood	\$ 1434
N95KKL	Laminate	1346

Dimensions

Width	25	Weight	40
Depth	30¼	Cubic Ft.	12.6
Height	16½		

- Wood table features matte/satin sheen
- Power grommet sold separately; reference pages 463-464 for pricing and details
- Optional surface grommet cutout available in G12, G17, and G23 cutout (+\$25 list)
- Optional side grommet cutout available in G23 cutout (+\$25 list)

45° Table

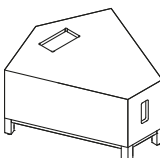
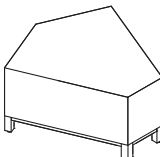

Optional Surface and Side Grommet Locations

N95LLW	Wood	\$ 1551
N95LLL	Laminate	1463

Dimensions

Width	31½	Weight	45.2
Depth	32¼	Cubic Ft.	16.3
Height	16½		

- Wood table features matte/satin sheen
- Power grommet sold separately; reference pages 463-464 for pricing and details
- Optional surface grommet cutout available in G12, G17, and G23 cutout (+\$25 list)
- Optional side grommet cutout available in G23 cutout (+\$25 list)

90° Table

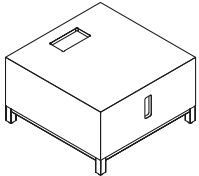
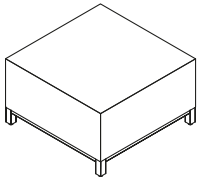

Optional Surface and Side Grommet Locations

Model No.

List Price

N95NNW	Wood	\$ 1610
N95NNL	Laminate	1522

Dimensions

Width	28	Weight	47.8
Depth	28	Cubic Ft.	13.1
Height	16½		

- Wood table features matte/satin sheen
- Power grommet sold separately; reference pages 463-464 for pricing and details
- Optional surface grommet cutout available in G12, G17, and G23 cutout (+\$25 list)
- Optional side grommet cutout available in G23 cutout (+\$25 list)

Small End Table

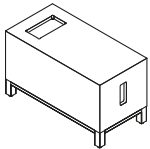
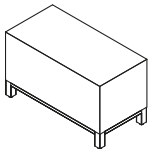

Optional Surface and Side Grommet Locations

N95PPW	Wood	\$ 1200
N95PPL	Laminate	1112

Dimensions

Width	14	Weight	31.8
Depth	28	Cubic Ft.	7.5
Height	16½		

- Wood table features matte/satin sheen
- Power grommet sold separately; reference pages 463-464 for pricing and details
- Optional surface grommet cutout available in G12, G17, and G23 cutout (+\$25 list)
- Optional side grommet cutout available in G23 cutout (+\$25 list)

Coffee Table

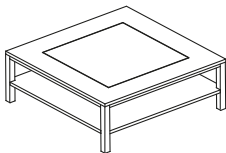

N95RRW	Wood	\$ 1873
N95RRL	Laminate	1785

Dimensions

Width	36	Weight	70
Depth	36	Cubic Ft.	16.8
Height	13¼		

- Power grommet option not available
- Wood table features matte/satin sheen
- Frosted ¾" thick glass insert

Console Table

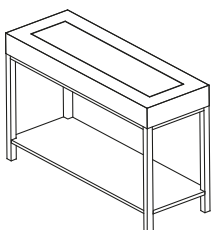

N95SSW	Wood	\$ 2001
N95SSL	Laminate	1914

Dimensions

Width	50	Weight	74.2
Depth	18	Cubic Ft.	26.4
Height	33½		

- Power grommet option not available
- Wood table features matte/satin sheen
- Frosted ¾" thick glass insert

To Order, Specify:

- 1. Model Number
- See page 367 for Swift options

Ganging Bracket

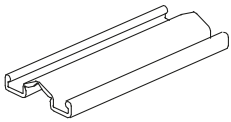

Model No. **List Price**

N95TT	Package of 20 (10 connections)	\$ 298
N95TU	Package of 60 (30 connections)	609

Dimensions

Width 1¹/₆
Depth 6

Pkg. 20
Weight 4
Cubic Ft. 2.3

- Ganging bracket recommended for use in modular applications for alignment of lounge and tables
- Ganging bracket intended for armless-to-armless or armless-to-table connections
- Two brackets recommended for each connection

Pkg. 60
Weight 17
Cubic Ft. 3

Metal Ganging Bracket Kit

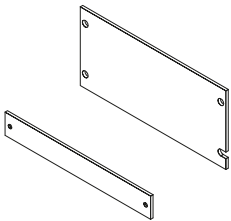

N95TR	1 Bracket Kit	\$ 83
--------------	---------------	--------------

Dimensions

Width 3³/₄
Depth 8

Weight 2
Cubic Ft. 0.05

- Ganging bracket recommended for use in static applications for rigid ganging
- Ganging bracket intended for armless-to-armless or armless-to-table connections
- One bracket kit used for each connection

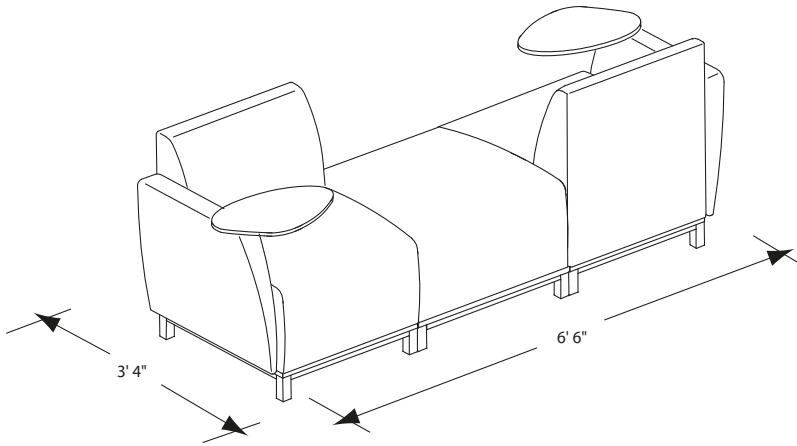

Model No.	Quantity	Description	Grade 1 List Price
N95MART	(2)	Tablet Right Arm	\$ 2184 ea
N95DD	(1)	One Seat Bench	1306
N95TT	(1)	Bracket Package of 20	298
Total			\$ 5972

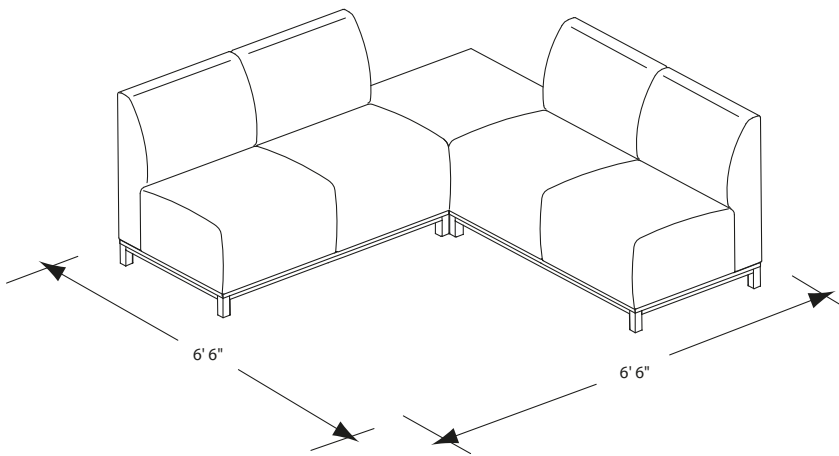

N95MB	(2)	Armless Two Seat Lounge	\$ 2446 ea
N95NNW	(1)	90° Table, Wood	1610
N95TT	(1)	Bracket Package of 20	298
Total			\$ 6800

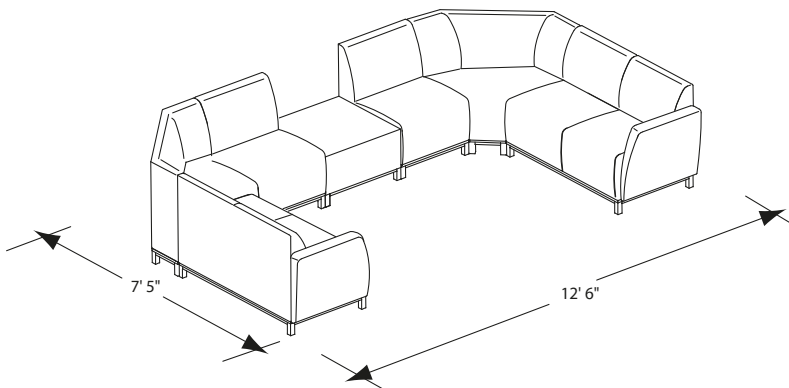

N95MBR	(1)	Two Seat Right Arm	\$ 2681
N95MK	(2)	90° Inside Corner	2446 ea
N95MA	(2)	One Seat Armless	1686 ea
N95MBL	(1)	Two Seat Left Arm	2681
N95NNW	(1)	90° Table, Wood	1610
N95TT	(1)	Bracket Package of 20	298
Total			\$ 15,534

Swift

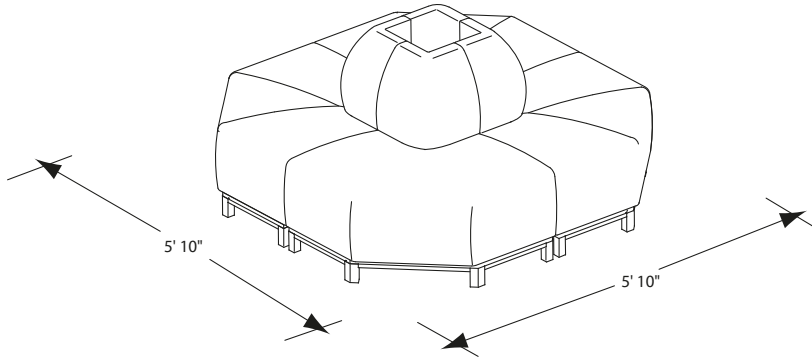

Model No.	Quantity	Description	Grade 1 List Price
N95MKA	(4)	90° Outside Corner	\$ 2446 ea
N95TT	(1)	Bracket Package of 20	298
Total			\$ 10,082

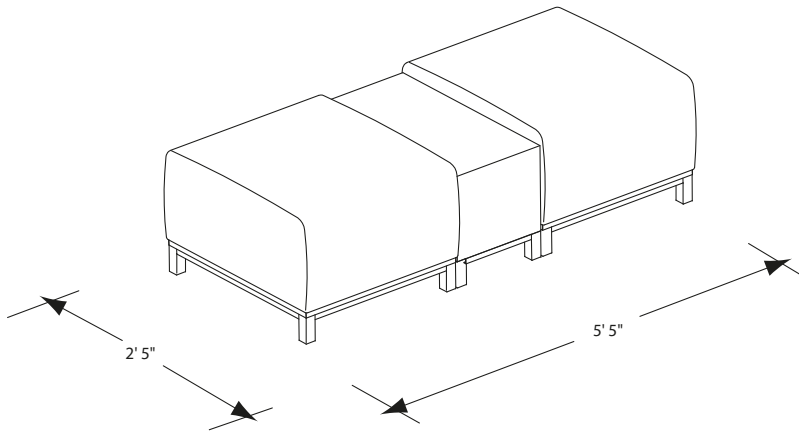

N95DD	(2)	One Seat Bench	\$ 1306 ea
N95PPW	(1)	Small End Table, Wood	1200
N95TT	(1)	Bracket Package of 20	298
Total			\$ 4110

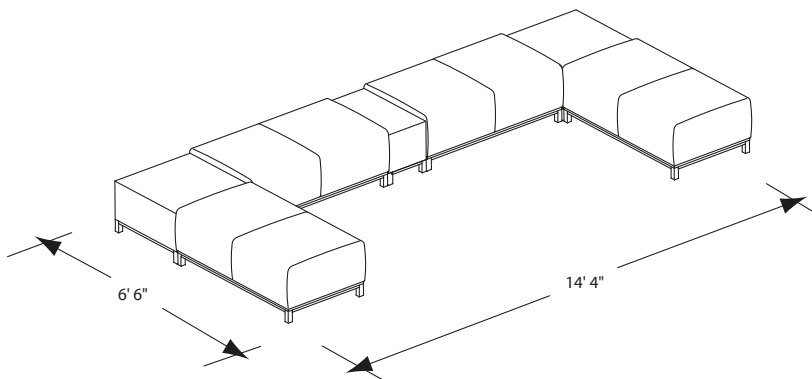

N95EE	(4)	Two Seat Bench	\$ 1804 ea
N95NNW	(2)	90° Table, Wood	1610 ea
N95PPW	(1)	Small End Table, Wood	1200
N95TT	(1)	Bracket Package of 20	298
Total			\$ 11,934

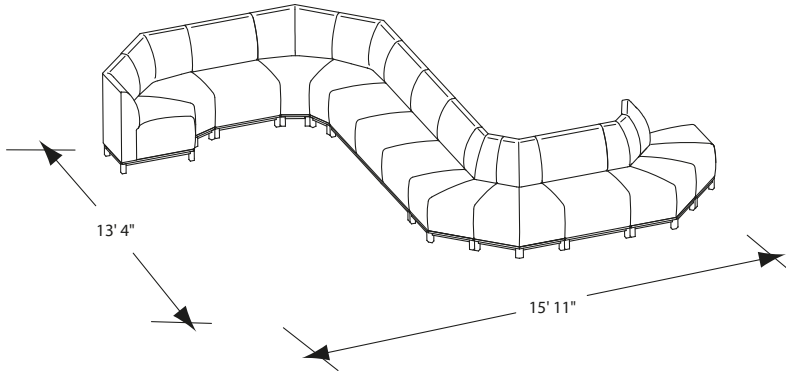

Model No.	Quantity	Description	Grade 1 List Price
N95MJ	(4)	45° Inside Corner	\$ 1890 ea
N95MJA	(4)	45° Outside Corner	1890 ea
N95MA	(2)	One Seat Armless	1686 ea
N95MC	(1)	Three Seat Armless	3208
N95TT	(1)	Bracket Package of 20	298
Total			\$ 21,998

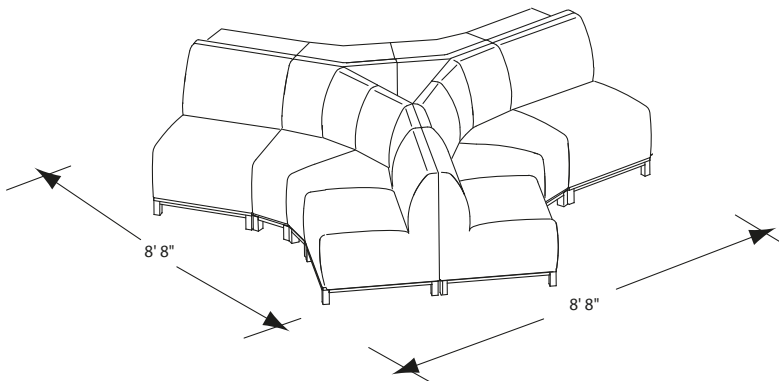

N95MA	(6)	One Seat Armless	\$ 1686 ea
N95MH	(6)	30° Inside Corner	1627 ea
N95TT	(1)	Bracket Package of 20	298
Total			\$ 20,176

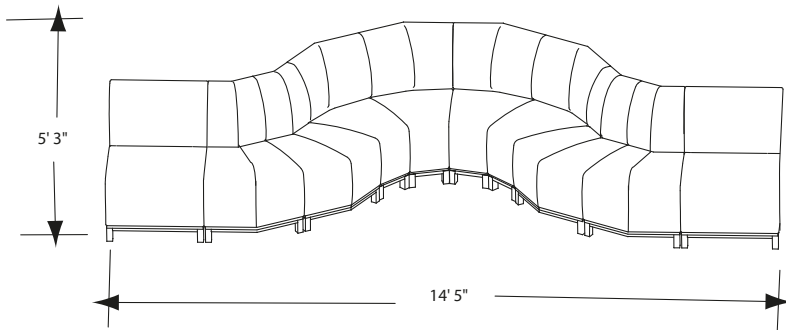

N95MA	(2)	One Seat Armless	\$ 1686 ea
N95MHA	(4)	30° Outside Corner	1627 ea
N95MH	(4)	30° Inside Corner	1627 ea
N95TT	(1)	Bracket Package of 20	298
Total			\$ 16,686

Swift

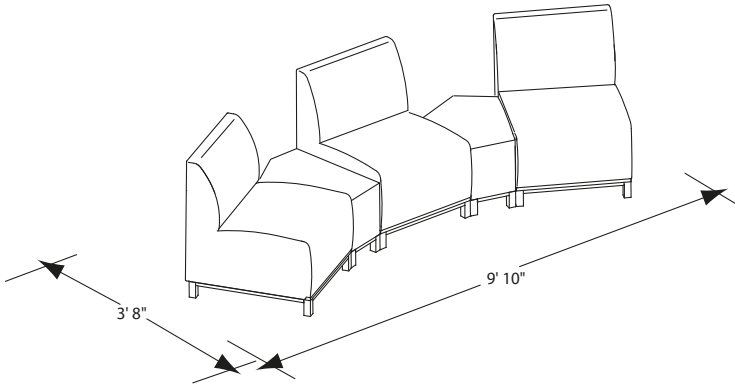

Model No.	Quantity	Description	Grade 1 List Price
N95MA	(3)	One Seat Armless	\$ 1686 ea
N95KKW	(2)	30° Corner Table	1434 ea
N95TT	(1)	Bracket Package of 20	298
Total			\$ 8224

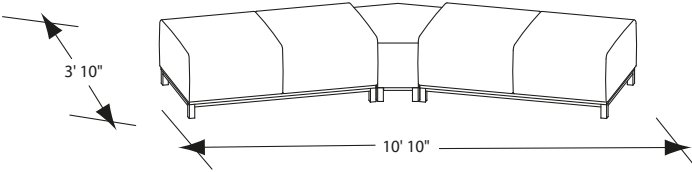

N95EE	(2)	Two Seat Bench	\$ 1804 ea
N95KKW	(1)	30° Corner Table	1434
N95TT	(1)	Bracket Package of 20	298
Total			\$ 5340

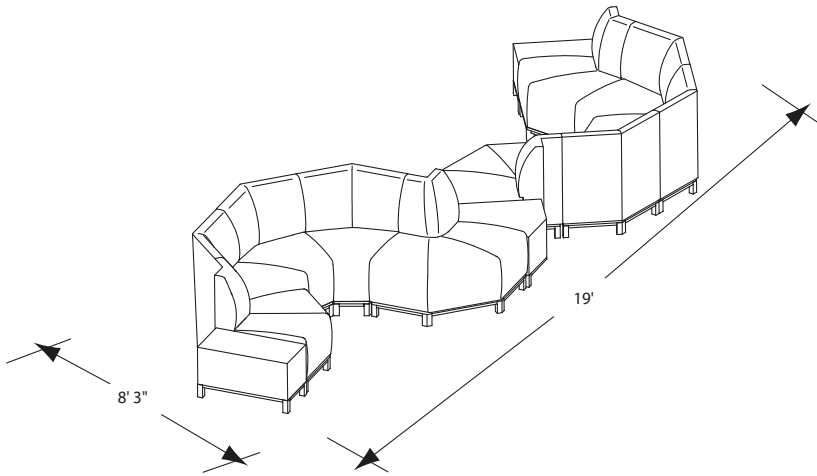

Model No.	Quantity	Description	Grade 1 List Price
N95PPW	(2)	Small End Table, Wood	\$ 1200 ea
N95MJA	(2)	45° Outside Corner Unit	1890 ea
N95MJ	(6)	45° Inside Corner Unit	1890 ea
N95MKA	(2)	90° Outside Corner Unit	2446 ea
N95KKW	(1)	30° Corner Table	1434
N95TT	(2)	Bracket Package of 20	298 ea
Total			\$ 24,442

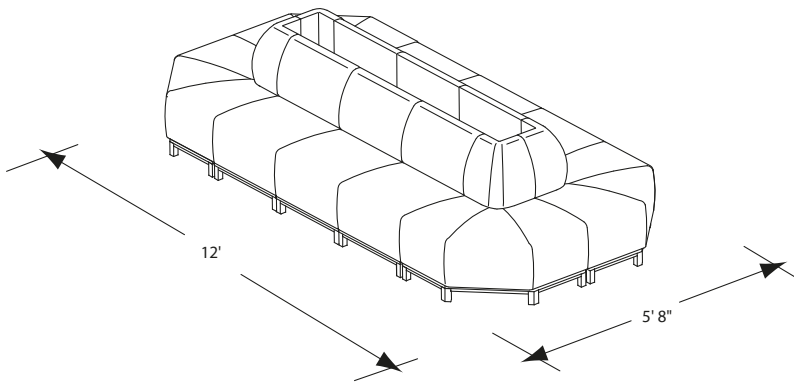

N95MKA	(4)	90° Outside Corner Unit	\$ 2446 ea
N95MA	(6)	One Seat Armless	1686 ea
N95TT	(2)	Bracket Package of 20	298 ea
Total			\$ 20,496

Tag[®]

TAG PRODUCT SPECIFICATIONS**60 Series****FRAME CONSTRUCTION**

- Legs are made of 7/8" x 14-gauge tubular steel in either powder coated Cinder or Platinum Metallic
- Cross members constructed of 3/4" x 14-gauge tubular steel
- Leg is joined to cross member bar with metal inert gas (MIG) welds
- Back brackets utilize sturdy 11-gauge steel plates
- Bariatric back brackets utilize sturdy 7-gauge steel plates
- Wall saving option available

SEAT CONSTRUCTION

- Contoured, blow molded, polyethylene seat pan with molded channels, which incorporate the seat frame cross members
- 1 1/4" thick high resilience polyurethane foam seat cushion covers a plywood panel for added comfort and support
- Seat pan is attached to the frame with 4 machine screws and threaded metal inserts (T-nuts)
- Bariatric seat pan is attached to the frame with 6 machine screws and threaded metal inserts (T-nuts)

BACK CONSTRUCTION—UPHOLSTERED

- Injection molded polypropylene plastic back rest
- Bariatric back features 9-ply curved plywood panel
- 3/4" high resilience polyurethane foam covers the front of the back rest while 1/4" high density polyurethane foam covers the back of the back rest
- Back rest is secured to the chair frame with 4 countersunk flat head screws, steel back plates and threaded metal inserts (T-nuts)

BACK CONSTRUCTION—WOOD

- 8-ply curved plywood back with decorative fasteners, steel back plates and threaded metal inserts (T-nuts)
- Bariatric back features 9-ply curved plywood back with decorative fasteners, steel back plates and threaded metal inserts (T-nuts)
- Features our silver ion antimicrobial finish which inhibits the growth of bacteria and microbes

ARMREST

- Injection molded black armrests connect to a metal tubular leg framework with a pressure fit

CONTRASTING FABRICS

- Available with contrasting fabric on seat and back

TABLE FRAME CONSTRUCTION

- Legs are made of 7/8" x 14-gauge tubular steel in either powder coated Cinder or Platinum Metallic
- Cross members constructed of 3/4" x 14-gauge tubular steel
- Leg is joined to cross member bar with metal inert gas (MIG) welds

TABLE TOP

- Veneer models feature 3/4" grade A slipmatched maple veneer tops
- Laminate models feature 3/4" particle board with laminate (HPL) top

GANGING BRACKET

- Set of two 2 1/2" x 5 3/4" polypropylene ganging brackets snap onto the legs of two like model chairs
- Set of two metal ganging brackets that fasten into the chair or table frames

TRANSPORT DOLLY

- Tubular steel frame construction with 8" semi-pneumatic ball bearing wheels
- Standard in green powder coat finish
- Designed to move up to 6 chairs at one time
- Removable handle allows for storage

STACKING CAPABILITIES

- Static and mobile guest chair models can be stacked up to 6 high
- Bariatric models do not stack

FINISH

- Black frames are finished with electrostatically baked-on textured powder coat paint
- Platinum Metallic frames are finished with electrostatically baked-on textured powder coat paint

GLIDES AND LEG END CAPS

- Black nylon ball glides are standard
- Black 7/8" diameter metal top caps used on armless models
- For rough textured or soft surface flooring, we recommend ordering the C8 glide for an additional upcharge

CASTERS

- Black, hard double wheel casters, which work on multiple surfaces, are standard
- Black, soft double wheel casters are available for use on hard floors; upcharge applies to this option

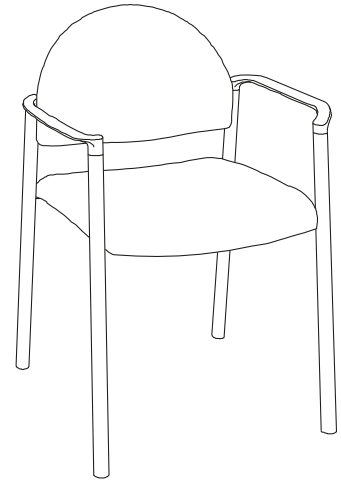

All Tag models may be ordered to meet TB133 fire code.

To order seating to meet the TB133 fire code, specify an "F" at the end of the model number (Ex: N60AAF).

Reference pages 465-493 for TB133 Fabric Matrix and pricing.

Please consult customer service for applicable Arc-Com, COM, Maharam, Momentum, Stinson or Ultrafabrics fabric.



For comprehensive sustainability information that includes LEED® point contribution, visit NationalOfficeFurniture.ecoScorecard.com.

FABRICS

Grade 1	American Graffiti
	Cali
	Plush
	Ridge
	Speedway
Grade 2	Stardust
	Cathedral
	COM
	Orbit
	Pixie
	Sedona
	Shenanigans
	Spectrum
Strand	
Tranquility	
Twilight	

Grade 3	Boardwalk
	COL
	Jacks
Grade 4	Pop Rocks
	Big City
	Bumble
	Connect Four
	Echo
Grade 6	Silvertex
	Essence/Ultraleather
	Flock
	Scribe

Grade 7	Brisa
	Brisa Distressed
	Promessa
	Silica
Grade L7	Davenport
Grade L8	Showcase

FINISHES

IM Brighton	CW Cordovan
NM Natural	DW Judicial
HN Honey	MH Mocha
CL Caramel	405 Designer White
TF Truffle	462 Cinder
AC Autumn	792 Sable
MC Amber	793 Acorn

LAMINATES

IM Brighton	405 Designer White
NM Natural	417 Mojave
HN2 Honey 2	418 Mouse
CL Caramel	419 Wallaby
TF Truffle	425 Shadow
AC2 Autumn 2	440 Cloud
MC Amber	461 Graphite
CW Cordovan	462 Cinder
DW Judicial	478 Platinum Grey
MH Mocha	488 Frosty White
*791 Palisander	491 Designer White Linear
792 Sable	492 Cinder Linear
793 Acorn	

*791 Palisander coordinates with (NM) Natural, (HN) Honey and (MH) Mocha finishes

FRAME COLORS

462 Cinder
501 Platinum Metallic (add \$34 list)

GLIDES

STD Standard
C8 Soft (add \$22 list)

CASTERS

C3 Hard (standard)
C4 Soft (add \$24 list)

To You In **10 DAYS** ...or Less

Shaded model numbers are available on our "To You in 10 Days or Less" Quick Delivery program and will be delivered within 10 days.

To Order, Specify:

1. Model Number
2. Fabric Grade Number
3. Cover Number
4. Finish (when applicable)
5. Frame Color
6. Glides/Casters

• See page 393 for Tag options

Upholstered Arc Back



Arms

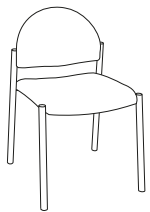

Armless

Model No. Grade / List Price

Quick Delivery Models: QN60AA, QN60BB

		1	2/COM	3/COL	4	6	7	L7	L8
N60AA	Arms	\$ 339	360	370	384	429	466	643	700
N60BB	Armless	312	333	343	357	402	439	616	673

Dimensions

Arm Width	23½	Seat Height	17¼	Arm Height	25	Arm Weight	20
Armless Width	19¾	Seat Depth	17½	Back Height	15¾	Armless Weight	19
Depth	21	Seat Width	18	Back Width	18	Cubic Ft.	11.1
Height	31						

- Platinum Metallic option available for a \$34 list upcharge
- Contrasting fabric option – specify X (i.e., N60AAX); see below. For list pricing, use your electronic specification tool or contact customer service
- Can stack 6 high
- Chairs will be shipped four per carton when applicable

Wall Saver Upholstered Arc Back

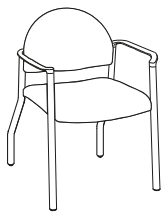

Arms

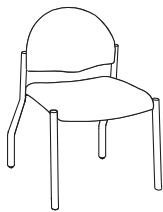

Armless

Quick Delivery Models: QN60SAA, QN60SBB

		1	2/COM	3/COL	4	6	7	L7	L8
N60SAA	Arms	\$ 426	447	457	471	516	553	730	787
N60SBB	Armless	399	420	430	444	489	526	703	760

Dimensions

Arm Width	23½	Seat Height	17¼	Arm Height	25	Arm Weight	20
Armless Width	19¾	Seat Depth	17½	Back Height	15¾	Armless Weight	19
Depth	22¼	Seat Width	18	Back Width	18	Cubic Ft.	11.1
Height	31						

- Platinum Metallic option available for a \$34 list upcharge
- Contrasting fabric option – specify X (i.e., N60SAAX); see below. For list pricing, use your electronic specification tool or contact customer service
- Can stack 6 high
- Chairs will be shipped four per carton when applicable

To Order Contrasting Fabric, Specify:

1. Model Number plus "X"
2. Back Fabric Grade Number/Cover Number
3. Seat Fabric Grade Number/Cover Number
4. Frame Color
5. Glides/Casters

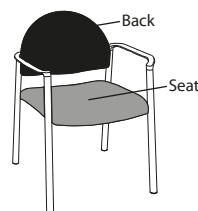

Contrasting Fabric

Upholstered Square Back

Model No. **Grade / List Price**

Quick Delivery Models: QN60CC, QN60DD

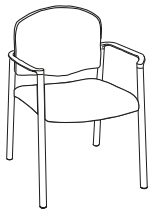

Arms

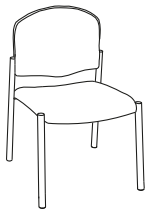

Armless

		1	2/COM	3/COL	4	6	7	L7	L8
N60CC	Arms	\$ 398	421	432	448	498	539	736	799
N60DD	Armless	370	393	404	420	470	511	708	771

Dimensions

Arm Width	23½	Seat Height	17¼	Arm Height	25	Arm Weight	20
Armless Width	19¾	Seat Depth	17½	Back Height	15¾	Armless Weight	19
Depth	21	Seat Width	18	Back Width	18	Cubic Ft.	11.1
Height	31						

- Platinum Metallic option available for a \$34 list upcharge
- Contrasting fabric option – specify X (i.e., N60CCX); see below. For list pricing, use your electronic specification tool or contact customer service
- Can stack 6 high
- Chairs will be shipped four per carton when applicable

Wall Saver Upholstered Square Back

Quick Delivery Models: QN60SCC, QN60SDD

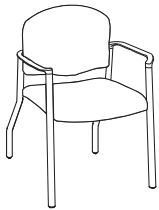

Arms

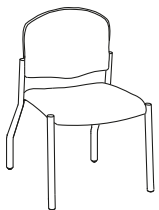

Armless

		1	2/COM	3/COL	4	6	7	L7	L8
N60SCC	Arms	\$ 485	508	519	535	585	626	823	886
N60SDD	Armless	458	481	492	508	558	599	796	859

Dimensions

Arm Width	23½	Seat Height	17¼	Arm Height	25	Arm Weight	20
Armless Width	19¾	Seat Depth	17½	Back Height	15¾	Armless Weight	19
Depth	22¼	Seat Width	18	Back Width	18	Cubic Ft.	11.1
Height	31						

- Platinum Metallic option available for a \$34 list upcharge
- Contrasting fabric option – specify X (i.e., N60SCCX); see below. For list pricing, use your electronic specification tool or contact customer service
- Can stack 6 high
- Chairs will be shipped four per carton when applicable

To Order Contrasting Fabric, Specify:

1. Model Number plus "X"
2. Back Fabric Grade Number/Cover Number
3. Seat Fabric Grade Number/Cover Number
4. Frame Color
5. Glides/Casters

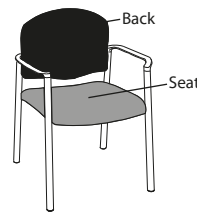

Contrasting Fabric

To Order, Specify:

1. Model Number
2. Fabric Grade Number
3. Cover Number
4. Finish (when applicable)
5. Frame Color
6. Glides/Casters

• See page 393 for Tag options

Wood Arc Back



Arms



Armless

Model No.

Grade / List Price

		1	2/COM	3/COL	4	6	7	L7	L8
N60AW	Arms	\$ 594	615	625	639	684	721	898	955
N60BW	Armless	568	589	599	613	658	695	872	929

Dimensions

Arm Width	23½	Seat Height	17¼	Arm Height	25	Arm Weight	20
Armless Width	19¾	Seat Depth	17½	Back Height	15¾	Armless Weight	19
Depth	21	Seat Width	18	Back Width	18	Cubic Ft.	11.1
Height	31						

- Platinum Metallic option available for a \$34 list upcharge
- Can stack 6 high
- Chairs will be shipped four per carton when applicable

Wall Saver Wood Arc Back

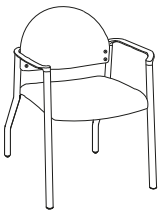

Arms

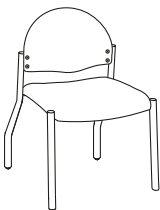

Armless

		1	2/COM	3/COL	4	6	7	L7	L8
N60SAW	Arms	\$ 682	703	713	727	772	809	986	1043
N60SBW	Armless	655	676	686	700	745	782	959	1016

Dimensions

Arm Width	23½	Seat Height	17¼	Arm Height	25	Arm Weight	20
Armless Width	19¾	Seat Depth	17½	Back Height	15¾	Armless Weight	19
Depth	22¼	Seat Width	18	Back Width	18	Cubic Ft.	11.1
Height	31						

- Platinum Metallic option available for a \$34 list upcharge
- Can stack 6 high
- Chairs will be shipped four per carton when applicable

Wood Square Back

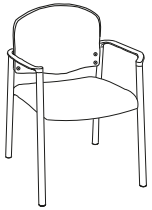

Arms



Armless

Model No.

Grade / List Price

		1	2/COM	3/COL	4	6	7	L7	L8
N60CW	Arms	\$ 594	615	625	639	684	721	898	955
N60DW	Armless	568	589	599	613	658	695	872	929

Dimensions

Arm Width	23½	Seat Height	17¼	Arm Height	25	Arm Weight	20
Armless Width	19¾	Seat Depth	17½	Back Height	15¾	Armless Weight	19
Depth	21	Seat Width	18	Back Width	18	Cubic Ft.	11.1
Height	31						

- Platinum Metallic option available for a \$34 list upcharge
- Can stack 6 high
- Chairs will be shipped four per carton when applicable

**Wall Saver
Wood Square Back**

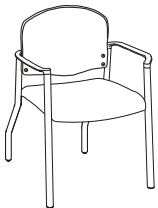

Arms

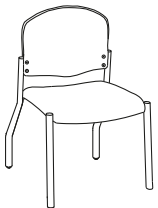

Armless

		1	2/COM	3/COL	4	6	7	L7	L8
N60SCW	Arms	\$ 682	703	713	727	772	809	986	1043
N60SDW	Armless	655	676	686	700	745	782	959	1016

Dimensions

Arm Width	23½	Seat Height	17¼	Arm Height	25	Arm Weight	20
Armless Width	19¾	Seat Depth	17½	Back Height	15¾	Armless Weight	19
Depth	22¼	Seat Width	18	Back Width	18	Cubic Ft.	11.1
Height	31						

- Platinum Metallic option available for a \$34 list upcharge
- Can stack 6 high
- Chairs will be shipped four per carton when applicable

To Order, Specify:

1. Model Number
2. Fabric Grade Number
3. Cover Number
4. Finish (when applicable)
5. Frame Color
6. Glides/Casters

• See page 393 for Tag options

**Wall Saver
Mobile
Upholstered Arc Back**

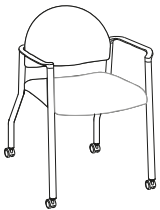

Arms

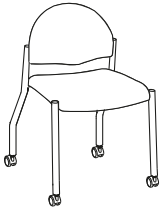

Armless

Model No.		Grade / List Price							
		1	2/COM	3/COL	4	6	7	L7	L8
N60SAAC	Arms	\$ 398	419	429	443	488	525	702	759
N60SBBC	Armless	370	391	401	415	460	497	674	731

Dimensions

Arm Width	23½	Seat Height	17¼	Arm Height	25	Arm Weight	20
Armless Width	19¾	Seat Depth	17½	Back Height	15¾	Armless Weight	19
Depth	22¼	Seat Width	18	Back Width	18	Cubic Ft.	11.1
Height	31						

- Platinum Metallic option available for a \$34 list upcharge
- Contrasting fabric option – specify X (i.e., N60SAACX); see below. For list pricing, use your electronic specification tool or contact customer service
- Can stack 6 high
- Chairs will be shipped four per carton when applicable

**Wall Saver
Mobile
Upholstered Square Back**

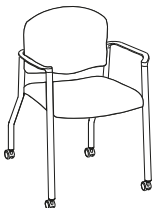

Arms

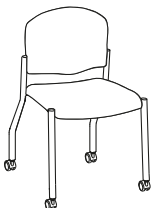

Armless

Model No.		Grade / List Price							
		1	2/COM	3/COL	4	6	7	L7	L8
N60SCCC	Arms	\$ 456	479	490	506	556	597	794	857
N60SDDC	Armless	428	451	462	478	528	569	766	829

Dimensions

Arm Width	23½	Seat Height	17¼	Arm Height	25	Arm Weight	20
Armless Width	19¾	Seat Depth	17½	Back Height	15¾	Armless Weight	19
Depth	22¼	Seat Width	18	Back Width	18	Cubic Ft.	11.1
Height	31						

- Platinum Metallic option available for a \$34 list upcharge
- Contrasting fabric option – specify X (i.e., N60SCCCX); see below. For list pricing, use your electronic specification tool or contact customer service
- Can stack 6 high
- Chairs will be shipped four per carton when applicable

To Order Contrasting Fabric, Specify:

1. Model Number plus "X"
2. Back Fabric Grade Number/Cover Number
3. Seat Fabric Grade Number/Cover Number
4. Frame Color
5. Glides/Casters

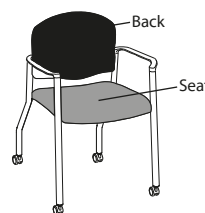

Contrasting Fabric

**Wall Saver
Mobile
Wood Arc Back**

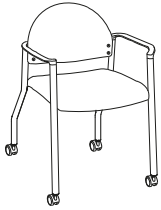

Arms

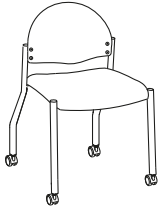

Armless

**Model
No.**

Grade / List Price

		1	2/COM	3/COL	4	6	7	L7	L8
N60SAWC	Arms	\$ 652	673	683	697	742	779	956	1013
N60SBWC	Armless	626	647	657	671	716	753	930	987

Dimensions

Arm Width	23½	Seat Height	17¼	Arm Height	25	Arm Weight	20
Armless Width	19¾	Seat Depth	17½	Back Height	15¾	Armless Weight	19
Depth	22¼	Seat Width	18	Back Width	18	Cubic Ft.	11.1
Height	31						

- Platinum Metallic option available for a \$34 list upcharge
- Can stack 6 high
- Chairs will be shipped four per carton when applicable

**Wall Saver
Mobile
Wood Square Back**

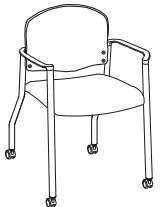

Arms

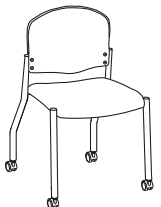

Armless

		1	2/COM	3/COL	4	6	7	L7	L8
N60SCWC	Arms	\$ 652	673	683	697	742	779	956	1013
N60SDWC	Armless	626	647	657	671	716	753	930	987

Dimensions

Arm Width	23½	Seat Height	17¼	Arm Height	25	Arm Weight	20
Armless Width	19¾	Seat Depth	17½	Back Height	15¾	Armless Weight	19
Depth	22¼	Seat Width	18	Back Width	18	Cubic Ft.	11.1
Height	31						

- Platinum Metallic option available for a \$34 list upcharge
- Can stack 6 high
- Chairs will be shipped four per carton when applicable

To Order, Specify:

1. Model Number
2. Fabric Grade Number
3. Cover Number
4. Finish (when applicable)
5. Frame Color
6. Glides

• See page 393 for Tag options

27" Bariatric Upholstered Arc Back (Mid-Sized)

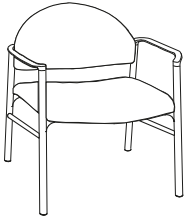

Arm

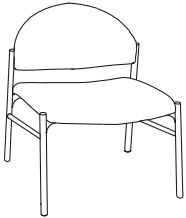

Armless

Model No.		Grade / List Price							
		1	2/COM	3/COL	4	6	7	L7	L8
N60EM	Arm	\$ 792	820	833	852	912	961	1198	1273
N60PM	Armless	792	820	833	852	912	961	1198	1273

Dimensions

Arm Width	27¼	Seat Height	18¼	Arm Height	25	Arm Weight	30
Armless Width	23½	Seat Depth	17¼	Back Height	15	Armless Weight	29
Depth	21¾	Seat Width	22	Back Width	22	Cubic Ft.	15.5
Height	31						

- Platinum Metallic option available for a \$34 list upcharge
- Tested to and meets 500 lb. weight load
- Contrasting fabric option – specify X (i.e., N60EMX); see below. For list pricing, use your electronic specification tool or contact customer service

Wall Saver 27" Bariatric Upholstered Arc Back (Mid-Sized)

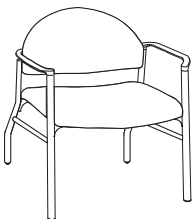

Arm

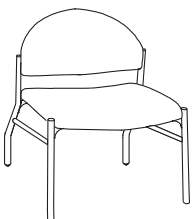

Armless

Model No.		Grade / List Price							
		1	2/COM	3/COL	4	6	7	L7	L8
N60SEM	Arm	\$ 880	908	921	940	1000	1049	1286	1361
N60SPM	Armless	880	908	921	940	1000	1049	1286	1361

Dimensions

Arm Width	27¼	Seat Height	18¼	Arm Height	25	Arm Weight	30
Armless Width	23½	Seat Depth	17¼	Back Height	15	Armless Weight	29
Depth	22¾	Seat Width	22	Back Width	22	Cubic Ft.	15.5
Height	31						

- Platinum Metallic option available for a \$34 list upcharge
- Tested to and meets 500 lb. weight load
- Contrasting fabric option – specify X (i.e., N60SEM X); see below. For list pricing, use your electronic specification tool or contact customer service

To Order Contrasting Fabric, Specify:

1. Model Number plus "X"
2. Back Fabric Grade Number/Cover Number
3. Seat Fabric Grade Number/Cover Number
4. Frame Color
5. Glides

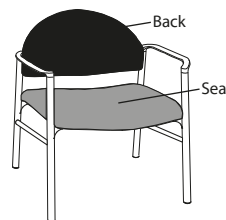

Contrasting Fabric

27" Bariatric Upholstered Square Back (Mid-Sized)

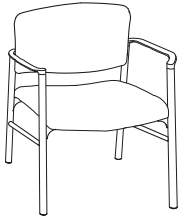

Arm

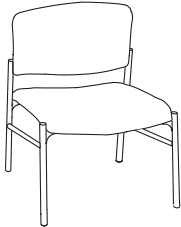

Armless

Model No.

Grade / List Price

		1	2/COM	3/COL	4	6	7	L7	L8
N60GM	Arm	\$ 850	878	891	910	970	1019	1256	1331
N60RM	Armless	850	878	891	910	970	1019	1256	1331

Dimensions

Arm Width	27¼	Seat Height	18¼	Arm Height	25	Arm Weight	30
Armless Width	23½	Seat Depth	17¼	Back Height	15	Armless Weight	29
Depth	21¾	Seat Width	22	Back Width	22	Cubic Ft.	15.5
Height	31						

- Platinum Metallic option available for a \$34 list upcharge
- Tested to and meets 500 lb. weight load
- Contrasting fabric option – specify X (i.e., N60GMX); see below. For list pricing, use your electronic specification tool or contact customer service

Wall Saver 27" Bariatric Upholstered Square Back (Mid-Sized)

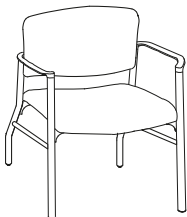

Arm

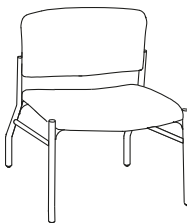

Armless

		1	2/COM	3/COL	4	6	7	L7	L8
N60SGM	Arm	\$ 938	966	979	998	1058	1107	1344	1419
N60SRM	Armless	938	966	979	998	1058	1107	1344	1419

Dimensions

Arm Width	27¼	Seat Height	18¼	Arm Height	25	Arm Weight	30
Armless Width	23½	Seat Depth	17¼	Back Height	15	Armless Weight	29
Depth	22¾	Seat Width	22	Back Width	22	Cubic Ft.	15.5
Height	31						

- Platinum Metallic option available for a \$34 list upcharge
- Tested to and meets 500 lb. weight load
- Contrasting fabric option – specify X (i.e., N60SGMX); see below. For list pricing, use your electronic specification tool or contact customer service

To Order Contrasting Fabric, Specify:

1. Model Number plus "X"
2. Back Fabric Grade Number/Cover Number
3. Seat Fabric Grade Number/Cover Number
4. Frame Color
5. Glides

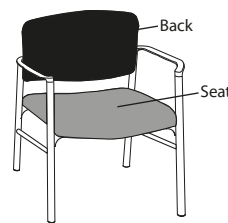

Contrasting Fabric

To Order, Specify:

1. Model Number
2. Fabric Grade Number
3. Cover Number
4. Finish (when applicable)
5. Frame Color
6. Glides

• See page 393 for Tag options

27" Bariatric Wood Arc Back (Mid-Sized)

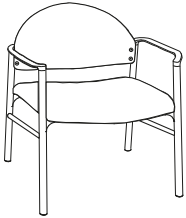

Arm

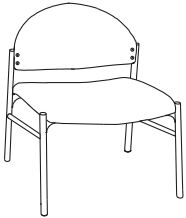

Armless

Model No.		Grade / List Price							
		1	2/COM	3/COL	4	6	7	L7	L8
N60EMW	Arm	\$ 1040	1058	1067	1080	1120	1153	1310	1361
N60PMW	Armless	1040	1058	1067	1080	1120	1153	1310	1361

Dimensions

Arm Width	27¼	Seat Height	18¼	Arm Height	25	Arm Weight	30
Armless Width	23½	Seat Depth	17¼	Back Height	15	Armless Weight	29
Depth	21¾	Seat Width	22	Back Width	22	Cubic Ft.	15.5
Height	31						

- Platinum Metallic option available for a \$34 list upcharge
- Tested to and meets 500 lb. weight load

Wall Saver 27" Bariatric Wood Arc Back (Mid-Sized)

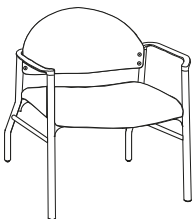

Arm

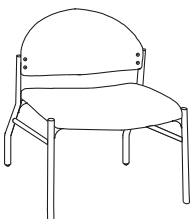

Armless

Model No.		Grade / List Price							
		1	2/COM	3/COL	4	6	7	L7	L8
N60SEMW	Arm	\$ 1128	1146	1155	1168	1208	1241	1398	1449
N60SPMW	Armless	1128	1146	1155	1168	1208	1241	1398	1449

Dimensions

Arm Width	27¼	Seat Height	18¼	Arm Height	25	Arm Weight	30
Armless Width	23½	Seat Depth	17¼	Back Height	15	Armless Weight	29
Depth	22¾	Seat Width	22	Back Width	22	Cubic Ft.	15.5
Height	31						

- Platinum Metallic option available for a \$34 list upcharge
- Tested to and meets 500 lb. weight load

**27" Bariatric
Wood Square Back
(Mid-Sized)**

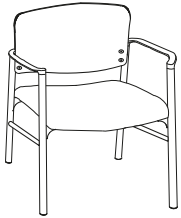

Arm

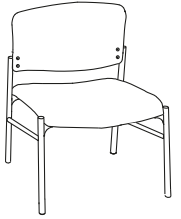

Armless

**Model
No.**

Grade / List Price

		1	2/COM	3/COL	4	6	7	L7	L8
N60GMW	Arm	\$ 1040	1058	1067	1080	1120	1153	1310	1361
N60RMW	Armless	1040	1058	1067	1080	1120	1153	1310	1361

Dimensions

Arm Width	27¼	Seat Height	18¼	Arm Height	25	Arm Weight	30
Armless Width	23½	Seat Depth	17¼	Back Height	15	Armless Weight	29
Depth	21¾	Seat Width	22	Back Width	22	Cubic Ft.	15.5
Height	31						

- Platinum Metallic option available for a \$34 list upcharge
- Tested to and meets 500 lb. weight load

**Wall Saver
27" Bariatric
Wood Square Back
(Mid-Sized)**

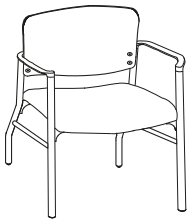

Arm

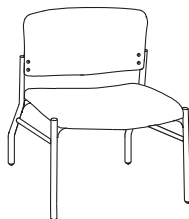

Armless

		1	2/COM	3/COL	4	6	7	L7	L8
N60SGMW	Arm	\$ 1128	1146	1155	1168	1208	1241	1398	1449
N60SRMW	Armless	1128	1146	1155	1168	1208	1241	1398	1449

Dimensions

Arm Width	27¼	Seat Height	18¼	Arm Height	25	Arm Weight	30
Armless Width	23½	Seat Depth	17¼	Back Height	15	Armless Weight	29
Depth	22¾	Seat Width	22	Back Width	22	Cubic Ft.	15.5
Height	31						

- Platinum Metallic option available for a \$34 list upcharge
- Tested to and meets 500 lb. weight load

To Order, Specify:

1. Model Number
2. Fabric Grade Number
3. Cover Number
4. Finish (when applicable)
5. Frame Color
6. Glides

• See page 393 for Tag options

35" Bariatric Upholstered Arc Back (Standard)

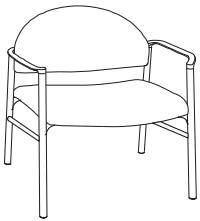

Arm

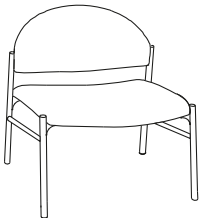

Armless

Model No.		Grade / List Price							
		1	2/COM	3/COL	4	6	7	L7	L8
N60EE	Arm	\$ 957	994	1011	1037	1117	1183	1498	1599
N60PP	Armless	957	994	1011	1037	1117	1183	1498	1599

Dimensions

Arm Width	35	Seat Height	18¼	Arm Height	25	Arm Weight	35
Armless Width	31¼	Seat Depth	17¼	Back Height	15	Armless Weight	34
Depth	21¾	Seat Width	30	Back Width	30	Cubic Ft.	20.8
Height	31						

- Platinum Metallic option available for a \$34 list upcharge
- Tested to and meets 500 lb. weight load
- Contrasting fabric option – specify X (i.e., N60EEX); see below. For list pricing, use your electronic specification tool or contact customer service

Wall Saver 35" Bariatric Upholstered Arc Back (Standard)

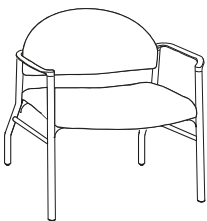

Arm

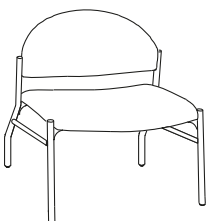

Armless

Model No.		Grade / List Price							
		1	2/COM	3/COL	4	6	7	L7	L8
N60SEE	Arm	\$ 1045	1082	1099	1125	1205	1271	1586	1687
N60SPP	Armless	1045	1082	1099	1125	1205	1271	1586	1687

Dimensions

Arm Width	35	Seat Height	18¼	Arm Height	25	Arm Weight	35
Armless Width	31¼	Seat Depth	17¼	Back Height	15	Armless Weight	34
Depth	22¾	Seat Width	30	Back Width	30	Cubic Ft.	20.8
Height	31						

- Platinum Metallic option available for a \$34 list upcharge
- Tested to and meets 500 lb. weight load
- Contrasting fabric option – specify X (i.e., N60SEEX); see below. For list pricing, use your electronic specification tool or contact customer service

To Order Contrasting Fabric, Specify:

1. Model Number plus "X"
2. Back Fabric Grade Number/Cover Number
3. Seat Fabric Grade Number/Cover Number
4. Frame Color
5. Glides

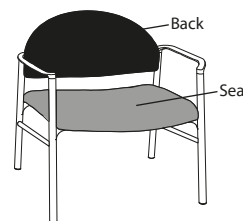

Contrasting Fabric

**35" Bariatric
Wood Arc Back
(Standard)**

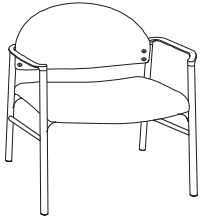

Arm

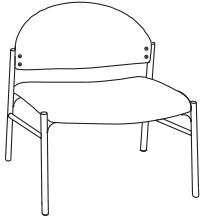

Armless

**Model
No.**

Grade / List Price

		1	2/COM	3/COL	4	6	7	L7	L8
N60EW	Arm	\$ 1194	1231	1248	1274	1354	1420	1735	1836
N60PW	Armless	1194	1231	1248	1274	1354	1420	1735	1836

Dimensions

Arm Width	35	Seat Height	18¼	Arm Height	25	Arm Weight	35
Armless Width	31¼	Seat Depth	17¼	Back Height	15	Armless Weight	34
Depth	21¾	Seat Width	30	Back Width	30	Cubic Ft.	20.8
Height	31						

- Platinum Metallic option available for a \$34 list upcharge
- Tested to and meets 500 lb. weight load

**Wall Saver
35" Bariatric
Wood Arc Back
(Standard)**

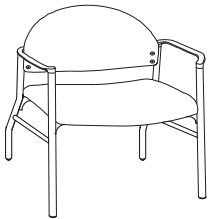

Arm

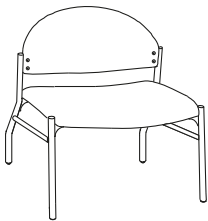

Armless

		1	2/COM	3/COL	4	6	7	L7	L8
N60SEEW	Arm	\$ 1280	1317	1334	1360	1440	1506	1821	1922
N60SPPW	Armless	1280	1317	1334	1360	1440	1506	1821	1922

Dimensions

Arm Width	35	Seat Height	18¼	Arm Height	25	Arm Weight	35
Armless Width	31¼	Seat Depth	17¼	Back Height	15	Armless Weight	34
Depth	22¾	Seat Width	30	Back Width	30	Cubic Ft.	20.8
Height	31						

- Platinum Metallic option available for a \$34 list upcharge
- Tested to and meets 500 lb. weight load

To Order, Specify:

1. Model Number
2. Fabric Grade Number
3. Cover Number
4. Finish (when applicable)
5. Frame Color
6. Glides

• See page 393 for Tag options

35" Bariatric Upholstered Square Back (Standard)

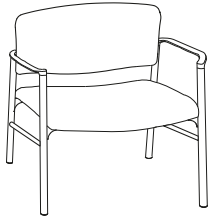

Arm

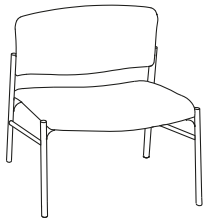

Armless

Model No.		Grade / List Price							
		1	2/COM	3/COL	4	6	7	L7	L8
N60GG	Arm	\$ 1014	1051	1068	1094	1174	1240	1555	1656
N60RR	Armless	1014	1051	1068	1094	1174	1240	1555	1656

Dimensions

Arm Width	35	Seat Height	18¾	Arm Height	25	Arm Weight	35
Armless Width	31¼	Seat Depth	17¼	Back Height	15	Armless Weight	34
Depth	21¾	Seat Width	30	Back Width	30	Cubic Ft.	20.8
Height	31						

- Platinum Metallic option available for a \$34 list upcharge
- Tested to and meets 500 lb. weight load
- Contrasting fabric option – specify X (i.e., N60GGX); see below. For list pricing, use your electronic specification tool or contact customer service

Wall Saver 35" Bariatric Upholstered Square Back (Standard)

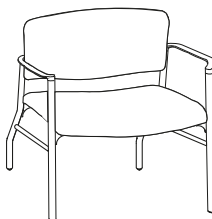

Arm

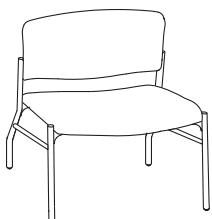

Armless

Model No.		Grade / List Price							
		1	2/COM	3/COL	4	6	7	L7	L8
N60SGG	Arm	\$ 1100	1137	1154	1180	1260	1326	1641	1742
N60SRR	Armless	1100	1137	1154	1180	1260	1326	1641	1742

Dimensions

Arm Width	35	Seat Height	18¾	Arm Height	25	Arm Weight	35
Armless Width	31¼	Seat Depth	17¼	Back Height	15	Armless Weight	34
Depth	22¾	Seat Width	30	Back Width	30	Cubic Ft.	20.8
Height	31						

- Platinum Metallic option available for a \$34 list upcharge
- Tested to and meets 500 lb. weight load
- Contrasting fabric option – specify X (i.e., N60SGGX); see below. For list pricing, use your electronic specification tool or contact customer service

To Order Contrasting Fabric, Specify:

1. Model Number plus "X"
2. Back Fabric Grade Number/Cover Number
3. Seat Fabric Grade Number/Cover Number
4. Frame Color
5. Glides

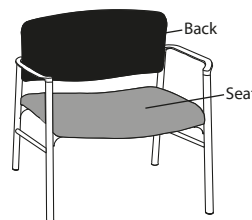

Contrasting Fabric

**35" Bariatric
Wood Square Back
(Standard)**

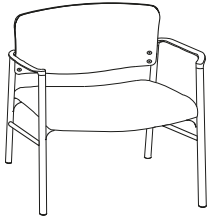

Arm

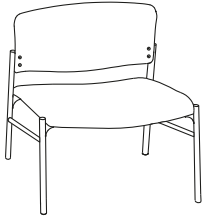

Armless

**Model
No.**

Grade / List Price

		1	2/COM	3/COL	4	6	7	L7	L8
N60GW	Arm	\$ 1194	1231	1248	1274	1354	1420	1735	1836
N60RW	Armless	1194	1231	1248	1274	1354	1420	1735	1836

Dimensions

Arm Width	35	Seat Height	18¼	Arm Height	25	Arm Weight	35
Armless Width	31¼	Seat Depth	17¼	Back Height	15	Armless Weight	34
Depth	21¾	Seat Width	30	Back Width	30	Cubic Ft.	20.8
Height	31						

- Platinum Metallic option available for a \$34 list upcharge
- Tested to and meets 500 lb. weight load

**Wall Saver
35" Bariatric
Wood Square Back
(Standard)**



Arm

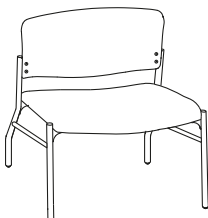

Armless

		1	2/COM	3/COL	4	6	7	L7	L8
N60SGGW	Arm	\$ 1280	1317	1334	1360	1440	1506	1821	1922
N60SRRW	Armless	1280	1317	1334	1360	1440	1506	1821	1922

Dimensions

Arm Width	35	Seat Height	18¼	Arm Height	25	Arm Weight	35
Armless Width	31¼	Seat Depth	17¼	Back Height	15	Armless Weight	34
Depth	22¾	Seat Width	30	Back Width	30	Cubic Ft.	20.8
Height	31						

- Platinum Metallic option available for a \$34 list upcharge
- Tested to and meets 500 lb. weight load

To Order, Specify:

1. Model Number
2. Fabric Grade Number
3. Cover Number
4. Wood Back Finish (when applicable)
5. Frame Color
6. Glides

• See page 393 for Tag options

Wall Saver Counter Stool Upholstered Arc Back

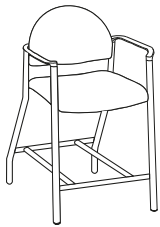

Arms

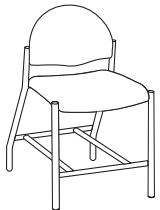

Armless

Model No.		Grade / List Price							
		1	2/COM	3/COL	4	6	7	L7	L8
N60SFA	Arms	\$ 683	704	714	728	773	810	987	1044
N60SFB	Armless	657	678	688	702	747	784	961	1018

Dimensions

Arm Width	23	Seat Height	21¼	Arm Height	31¾	Arm Weight	29
Armless Width	20	Seat Depth	17½	Back Height	15¾	Armless Weight	28
Depth	23	Seat Width	18	Back Width	18	Cubic Ft.	17.3
Height	38						

- Platinum Metallic option available for a \$34 list upcharge
- Contrasting fabric option – specify X (i.e., N60SFAX); see below. For list pricing, use your electronic specification tool or contact customer service

Wall Saver Counter Stool Upholstered Square Back

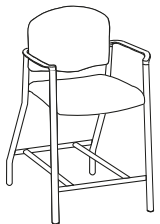

Arms

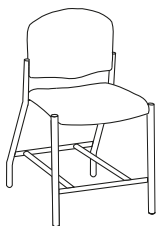

Armless

Model No.		Grade / List Price							
		1	2/COM	3/COL	4	6	7	L7	L8
N60SFC	Arms	\$ 741	764	775	791	841	882	1079	1142
N60SFD	Armless	715	738	749	765	815	856	1053	1116

Dimensions

Arm Width	23	Seat Height	21¼	Arm Height	31¾	Arm Weight	29
Armless Width	20	Seat Depth	17½	Back Height	15¾	Armless Weight	28
Depth	23	Seat Width	18	Back Width	18	Cubic Ft.	17.3
Height	38						

- Platinum Metallic option available for a \$34 list upcharge
- Contrasting fabric option – specify X (i.e., N60SFCX); see below. For list pricing, use your electronic specification tool or contact customer service

To Order Contrasting Fabric, Specify:

1. Model Number plus "X"
2. Back Fabric Grade Number/Cover Number
3. Seat Fabric Grade Number/Cover Number
4. Frame Color
5. Glides

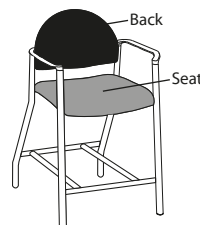

Contrasting Fabric

**Wall Saver Counter Stool
Wood Arc Back**

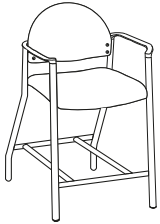

Arms

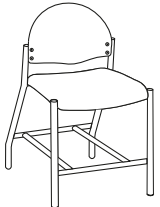

Armless

Model No.

Grade / List Price

		1	2/COM	3/COL	4	6	7	L7	L8
N60SFAW	Arms	\$ 931	952	962	976	1021	1058	1235	1292
N60SFBW	Armless	905	926	936	950	995	1032	1209	1266

Dimensions

Arm Width	23	Seat Height	21¼	Arm Height	31¾	Arm Weight	29
Armless Width	20	Seat Depth	17½	Back Height	15¾	Armless Weight	28
Depth	23	Seat Width	18	Back Width	18	Cubic Ft.	17.3
Height	38						

- Platinum Metallic option available for a \$34 list upcharge

**Wall Saver Counter Stool
Wood Square Back**

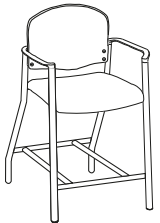

Arms

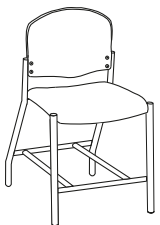

Armless

		1	2/COM	3/COL	4	6	7	L7	L8
N60SFCW	Arms	\$ 931	952	962	976	1021	1058	1235	1292
N60SFDW	Armless	905	926	936	950	995	1032	1209	1266

Dimensions

Arm Width	23	Seat Height	21¼	Arm Height	31¾	Arm Weight	29
Armless Width	20	Seat Depth	17½	Back Height	15¾	Armless Weight	28
Depth	23	Seat Width	18	Back Width	18	Cubic Ft.	17.3
Height	38						

- Platinum Metallic option available for a \$34 list upcharge

To Order, Specify:

1. Model Number
2. Fabric Grade Number
3. Cover Number
4. Wood Back Finish (when applicable)
5. Frame Color
6. Glides

• See page 393 for Tag options

Wall Saver Barstool Upholstered Arc Back

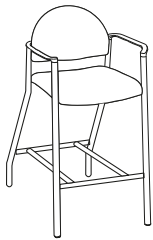

Arms

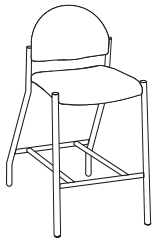

Armless

Model No.		Grade / List Price							
		1	2/COM	3/COL	4	6	7	L7	L8
N60STA	Arms	\$ 683	704	714	728	773	810	987	1044
N60STB	Armless	657	678	688	702	747	784	961	1018

Dimensions

Arm Width	23	Seat Height	30¼	Arm Height	37¾	Arm Weight	32
Armless Width	20	Seat Depth	17½	Back Height	15¾	Armless Weight	31
Depth	23	Seat Width	18	Back Width	18	Cubic Ft.	20.8
Height	44						

- Platinum Metallic option available for a \$34 list upcharge
- Contrasting fabric option – specify X (i.e., N60STAX); see below. For list pricing, use your electronic specification tool or contact customer service

Wall Saver Barstool Upholstered Square Back

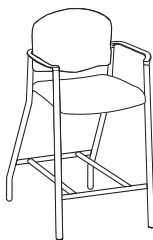

Arms

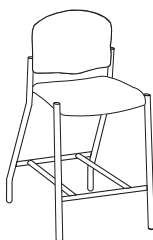

Armless

Model No.		Grade / List Price							
		1	2/COM	3/COL	4	6	7	L7	L8
N60STC	Arms	\$ 741	764	775	791	841	882	1079	1142
N60STD	Armless	715	738	749	765	815	856	1053	1116

Dimensions

Arm Width	23	Seat Height	30¼	Arm Height	37¾	Arm Weight	32
Armless Width	20	Seat Depth	17½	Back Height	15¾	Armless Weight	31
Depth	23	Seat Width	18	Back Width	18	Cubic Ft.	20.8
Height	44						

- Platinum Metallic option available for a \$34 list upcharge
- Contrasting fabric option – specify X (i.e., N60STCX); see below. For list pricing, use your electronic specification tool or contact customer service

To Order Contrasting Fabric, Specify:

1. Model Number plus “X”
2. Back Fabric Grade Number/Cover Number
3. Seat Fabric Grade Number/Cover Number
4. Frame Color
5. Glides

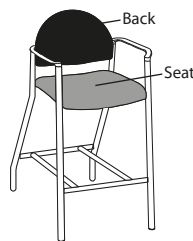

Contrasting Fabric

**Wall Saver
Barstool
Wood Arc Back**

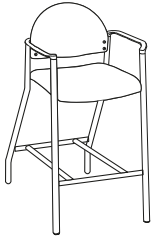

Arms

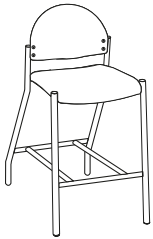

Armless

**Model
No.**

Grade / List Price

		1	2/COM	3/COL	4	6	7	L7	L8
N60STAW	Arms	\$ 931	952	962	976	1021	1058	1235	1292
N60STBW	Armless	905	926	936	950	995	1032	1209	1266

Dimensions

Arm Width	23	Seat Height	30¼	Arm Height	37¼	Arm Weight	32
Armless Width	20	Seat Depth	17½	Back Height	15¾	Armless Weight	31
Depth	23	Seat Width	18	Back Width	18	Cubic Ft.	20.8
Height	44						

- Platinum Metallic option available for a \$34 list upcharge

**Wall Saver
Barstool
Wood Square Back**

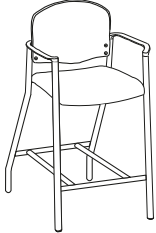

Arms

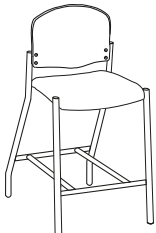

Armless

		1	2/COM	3/COL	4	6	7	L7	L8
N60STCW	Arms	\$ 931	952	962	976	1021	1058	1235	1292
N60STDW	Armless	905	926	936	950	995	1032	1209	1266

Dimensions

Arm Width	23	Seat Height	30¼	Arm Height	37¼	Arm Weight	32
Armless Width	20	Seat Depth	17½	Back Height	15¾	Armless Weight	31
Depth	23	Seat Width	18	Back Width	18	Cubic Ft.	20.8
Height	44						

- Platinum Metallic option available for a \$34 list upcharge

To You In
10 DAYS
...or Less

Shaded model numbers are available on our "To You in 10 Days or Less" Quick Delivery program and will be delivered within 10 days.

To Order, Specify:

1. Model Number
2. Finish Designator
3. Frame Color

• See page 393 for Tag options

End Table

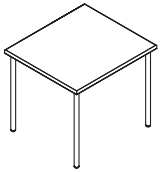

Model No. Grade / List Price

N60SGW Wood Top \$ 535

N60SGL Laminate Top \$ 450

Dimensions

Width 20
Depth 18
Height 17¾

Weight 15
Cubic Ft. 6.1

- Platinum Metallic option available for a \$34 list upcharge

Corner Table



N60SHW Wood Top \$ 754

N60SHL Laminate Top \$ 670

Dimensions

Width 28
Depth 28
Height 17¾

Weight 24
Cubic Ft. 11.5

- Platinum Metallic option available for a \$34 list upcharge

Magazine Table

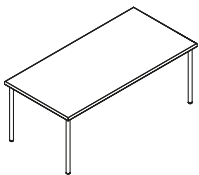

N60SKW Wood Top \$ 732

N60SKL Laminate Top \$ 647

Dimensions

Width 39¾
Depth 19¾
Height 16

Weight 24
Cubic Ft. 10.7

- Platinum Metallic option available for a \$34 list upcharge

Metal Ganging Brackets

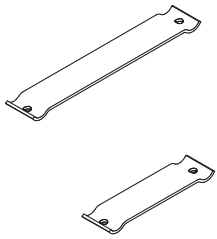

Model No. **Grade / List Price**

N60SJ	Arm-to-Arm Connection	\$ 65
N60SL	Armless-to-Armless Connection	65

Dimensions N60SJ

Width	1½	Weight	1
Depth	9¼	Cubic Ft.	0.01
Height	5⁄₁₆		

Dimensions N60SL

Width	1½	Weight	1
Depth	7⁄₁₆	Cubic Ft.	0.01
Height	5⁄₁₆		

- Specify model number only
- N60SL also is used for arm-to-table connection and armless-to-table connection
- Two brackets come for each connection
- Arm-to-arm connection separates seats by approximately 5¾"
- Armless-to-armless connection separates seats by approximately 4"

Ganging Bracket

Quick Delivery Model: QN60GB

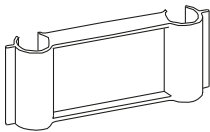

N60GB	\$ 50
--------------	--------------

Dimensions

Width	5¾	Weight	1
Depth	1	Cubic Ft.	0.01
Height	2		

- Specify model number only
- One pair is required for each ganging connection
- Sold in packages of five pairs
- Used to gang like models
- If chair is purchased on same order, brackets will be shipped inside chair carton
- Standard black

Transport Dolly

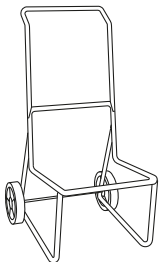

N60D0	\$ 511
--------------	---------------

Dimensions

Width	19	Weight	21
Depth	32½	Cubic Ft.	10
Height	44¾		

- Specify model number only
- Accommodates six stacked chairs
- Green powder coat finish
- Does not ship in a carton

Timberlane™

Timberlane

Timberlane

TIMBERLANE PRODUCT SPECIFICATIONS—GUEST, TANDEM, BARIATRIC, GANGING TABLES 39 Series

FRAME CONSTRUCTION

- Frames are constructed of exterior maple with joints double doweled and securely glued for maximum joint stability
- Tandem frame is 1" wide on arms
- Bariatric frame is 1¼" wide on arms
- Non-marring nylon glides

ARM CONSTRUCTION

- Available with black protective polyurethane arm caps for added durability

SEAT CONSTRUCTION

- 2" of high grade polyurethane foam covers a solid seat panel
- Corner blocks are screwed and glued into all four corners of the seat

BACK CONSTRUCTION

(39B, 39L, 39D, 39S MODELS)

- Features exterior slats cut from molded maple veneer

(39U, 39E, 39H, 39A MODELS)

- High grade polyurethane foam covers a high density plywood back

CONTRASTING FABRICS

- Available with contrasting fabric on seat and back

FINISH

- A catalyzed top coat resists denting, peeling and reactions to chemicals
- Can be cleaned with a damp cloth
- When specifying Brighton and Natural finish on tables, variation in color is acceptable due to the nature of beech wood characteristics
- Features our silver ion antimicrobial finish which inhibits the growth of bacteria and microbes

WOOD SPECIES

- Hard maple

TABLES

- Veneer models feature ¾" grade A, slipmatched, European beech veneer tops with European beech facade rails and legs
- Laminate models feature ¾" particle board with laminate (HPL) top and European beech facade rails and legs

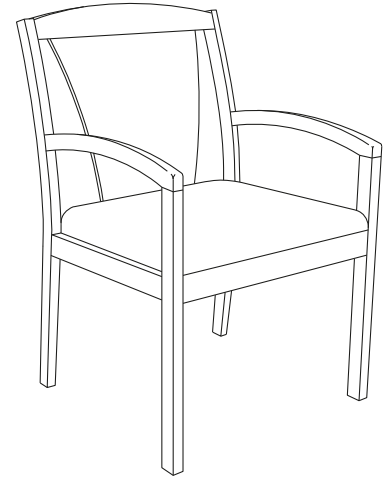

All Timberlane models may be ordered to meet TB133 fire code.

To order seating to meet the TB133 fire code, specify an "F" at the end of the model number (Ex: 39U-GWXXF).

Reference pages 465-493 for TB133 Fabric Matrix and pricing.

Please consult customer service for applicable Arc-Com, COM, Maharam, Momentum, Stinson or Ultrafabrics fabric.



For comprehensive sustainability information that includes LEED® point contribution, visit NationalOfficeFurniture.ecoScorecard.com.

FABRICS

Grade 1	American Graffiti
	Cali
	Plush
	Ridge
	Speedway
Grade 2	Stardust
	Cathedral
	COM
	Orbit
	Pixie
	Sedona
	Shenanigans
	Spectrum
	Strand
Tranquility	
Twilight	

Grade 3	Boardwalk
	COL
	Jacks
	Pop Rocks
Grade 4	Big City
	Bumble
	Connect Four
	Echo
Grade 6	Silvertex
	Essence/Ultraleather
	Flock
	Scribe

Grade 7	Brisa
	Brisa Distressed
	Promessa
	Silica
Grade L7	Davenport
Grade L8	Showcase

FINISHES

IM	Brighton	CW	Cordovan
NM	Natural	DW	Judicial
HN	Honey	MH	Mocha
CL	Caramel	405	Designer White
TF	Truffle	462	Cinder
AC	Autumn	792	Sable
MC	Amber	793	Acorn

LAMINATES

Tables Only

IM	Brighton	MH	Mocha
NM	Natural	405	Designer White
HN2	Honey 2	462	Cinder
CL	Caramel	*791NM	Palisander/Natural
TF	Truffle	*791HN	Palisander/Honey
AC2	Autumn 2	*791MH	Palisander/Mocha
MC	Amber	792	Sable
CW	Cordovan	793	Acorn
DW	Judicial		

*Palisander laminate table tops will have (NM) Natural, (HN) Honey or (MH) Mocha legs

To You In
10 DAYS
...or Less

Shaded model numbers are available on our "To You in 10 Days or Less" Quick Delivery program and will be delivered within 10 days.

To Order, Specify:

1. Model Number
2. Fabric Grade Number
3. Cover Number
4. Finish Designator

• See page 417 for Timberlane options

Single Panel Arms



Polyurethane Arm Caps

Model No.	Grade / List Price								
		1	2/COM	3/COL	4	6	7	L7	L8
39L-GWXX Wood Back	\$ 710	727	736	748	785	816	964	1011	
39L-GWXXT Wood Back/Black Polyurethane Arm Caps	797	815	824	837	877	910	1067	1118	
39H-GWXX Upholstered Back	722	749	761	780	838	886	1114	1187	
39H-GWXXT Upholstered Back/Black Polyurethane Arm Caps	808	824	832	843	878	907	1045	1089	

Dimensions

				39L-GWXX & GWXXT		39H-GWXX & GWXXT	
Width	22	Arm Height	25¾	Seat Width	20½	Seat Width	20½
Depth	24	Seat Height	18½	Seat Depth	19½	Seat Depth	18
Height	35	Cubic Ft.	13.4	Weight	30	Weight	33

• Contrasting fabric option – specify X (i.e., 39H-GWXXX). For list pricing, use your electronic specification tool or contact customer service

"V" Back Arms



Polyurethane Arm Caps

Model No.	Grade / List Price								
		1	2/COM	3/COL	4	6	7	L7	L8
39B-GWXX Wood Back	\$ 710	727	736	748	785	816	964	1011	
39B-GWXXT Wood Back/Black Polyurethane Arm Caps	797	815	824	837	877	910	1067	1118	
39E-GWXX Upholstered Back	722	749	761	780	838	886	1114	1187	
39E-GWXXT Upholstered Back/Black Polyurethane Arm Caps	808	838	852	873	938	991	1247	1329	

Dimensions

				39B-GWXX & GWXXT		39E-GWXX & GWXXT	
Width	22	Arm Height	25¾	Seat Width	20½	Seat Width	20½
Depth	24	Seat Height	18½	Seat Depth	19½	Seat Depth	18
Height	35	Cubic Ft.	13.4	Weight	30	Weight	33

• Contrasting fabric option – specify X (i.e., 39E-GWXXX). For list pricing, use your electronic specification tool or contact customer service

To Order Contrasting Fabric, Specify:

1. Model Number plus "X"
2. Back Fabric Grade Number/Cover Number
3. Seat Fabric Grade Number/Cover Number
4. Finish Designator

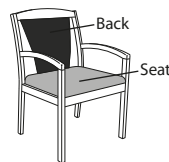

Contrasting Fabric

Double Panel Arms



Polyurethane Arm Caps

Model No.

Grade / List Price

		1	2/COM	3/COL	4	6	7	L7	L8
39D-GWXX	Wood Back	\$ 722	739	748	760	797	828	976	1023
39D-GWXXT	Wood Back/Black Polyurethane Arm Caps	808	826	835	848	888	921	1078	1129

Dimensions

Width	22	Arm Height	25¾	Seat Width	20½	Weight	30
Depth	24	Seat Height	18½			Cubic Ft.	13.4
Height	35	Seat Depth	19½				

Full Back Arms



Polyurethane Arm Caps

Quick Delivery Model: Q39U-GWXX

		1	2/COM	3/COL	4	6	7	L7	L8
39U-GWXX	Upholstered Back	\$ 729	756	768	787	845	893	1121	1194
39U-GWXXT	Upholstered Back/Black Polyurethane Arm Caps	816	846	860	881	946	999	1255	1337

Dimensions

Width	22	Arm Height	25¾	Seat Width	20½	Weight	33
Depth	24	Seat Height	18½			Cubic Ft.	13.4
Height	35	Seat Depth	18				

• Contrasting fabric option – specify X (i.e., 39U-GWXXX). For list pricing, use your electronic specification tool or contact customer service

To Order Contrasting Fabric, Specify:

1. Model Number plus "X"
2. Back Fabric Grade Number/Cover Number
3. Seat Fabric Grade Number/Cover Number
4. Finish Designator

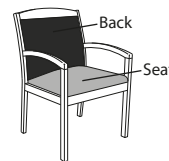

Contrasting Fabric

To Order, Specify:

1. Model Number
2. Fabric Grade Number
3. Cover Number
4. Finish Designator

• See page 417 for Timberlane options

Slatback Arms



Model No.		Grade / List Price							
		1	2/COM	3/COL	4	6	7	L7	L8
39S-GWXX	Wood Back	\$ 759	776	785	797	834	865	1013	1060
39S-GWXXT	Wood Back/Black Polyurethane Arm Caps	844	862	871	884	924	957	1114	1165

Dimensions

Width	22	Arm Height	25¾	Seat Width	20½	Weight	30
Depth	24	Seat Height	18½			Cubic Ft.	13.4
Height	35	Seat Depth	19½				



Polyurethane Arm Caps

¾ Back Arms



Model No.		Grade / List Price							
		1	2/COM	3/COL	4	6	7	L7	L8
39A-GWXX	Upholstered Back	\$ 723	748	760	778	833	878	1095	1164
39A-GWXXT	Upholstered Back/Black Polyurethane Arm Caps	809	834	846	864	919	964	1181	1250

Dimensions

Width	22	Arm Height	25¾	Seat Width	20½	Weight	33
Depth	24	Seat Height	18½			Cubic Ft.	13.4
Height	35	Seat Depth	18				

• Contrasting fabric option – specify X (i.e., 39A-GWXXX). For list pricing, use your electronic specification tool or contact customer service

To Order Contrasting Fabric, Specify:

1. Model Number plus "X"
2. Back Fabric Grade Number/Cover Number
3. Seat Fabric Grade Number/Cover Number
4. Finish Designator



Polyurethane Arm Caps

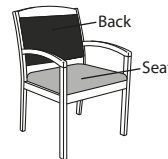

Contrasting Fabric

**¾ Back
Two Seat
Tandem**

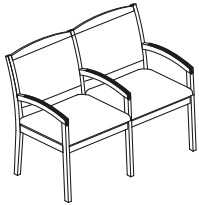
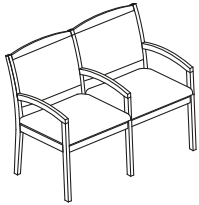

Polyurethane Arm Caps

**Model
No.**

Grade / List Price

		1	2/COM	3/COL	4	6	7	L7	L8
39A-TAA	Upholstered Back	\$ 1320	1361	1381	1410	1500	1574	1928	2042
39A-TAAT	Upholstered Back/Black Polyurethane Arm Caps	1452	1493	1513	1542	1632	1706	2060	2174

Dimensions

Width	43	Arm Height	25¾	Seat Width	20½	Weight	49
Depth	24	Seat Height	18½			Cubic Ft.	26.0
Height	35	Seat Depth	18				

- Contrasting fabric option – specify X (i.e., 39A-TAAX). For list pricing, use your electronic specification tool or contact customer service

**¾ Back
Three Seat
Tandem**

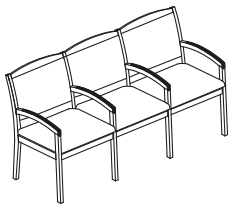
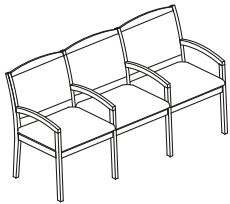

Polyurethane Arm Caps

		1	2/COM	3/COL	4	6	7	L7	L8
39A-TAAA	Upholstered Back	\$ 1998	2060	2090	2133	2268	2379	2911	3081
39A-TAAAT	Upholstered Back/Black Polyurethane Arm Caps	2170	2232	2262	2305	2440	2551	3083	3253

Dimensions

Width	64¾	Arm Height	25¾	Seat Width	20½	Weight	73
Depth	24	Seat Height	18½			Cubic Ft.	37.6
Height	35	Seat Depth	18				

- Contrasting fabric option – specify X (i.e., 39A-TAAX). For list pricing, use your electronic specification tool or contact customer service

To Order Contrasting Fabric, Specify:

1. Model Number plus "X"
2. Back Fabric Grade Number/Cover Number
3. Seat Fabric Grade Number/Cover Number
4. Finish Designator

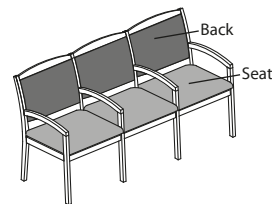

Contrasting Fabric

To Order, Specify:

1. Model Number
2. Fabric Grade Number
3. Cover Number
4. Finish Designator

• See page 417 for Timberlane options

¾ Back Bariatric

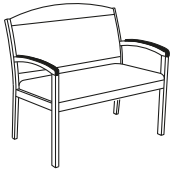
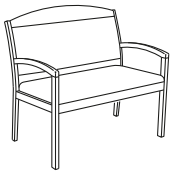

Polyurethane Arm Caps

Model No.

Grade / List Price

		1	2/COM	3/COL	4	6	7	L7	L8
39A-BWAA	Upholstered Back	\$ 1378	1422	1443	1473	1568	1646	2020	2140
39A-BWAAT	Upholstered Back/Black Polyurethane Arm Caps	1463	1507	1528	1558	1653	1731	2105	2225

Dimensions

Width	34¾	Arm Height	25¾	Seat Width	32	Weight	47
Depth	24	Seat Height	18½			Cubic Ft.	24.5
Height	35	Seat Depth	18				

- Tested to and meets 500 lb. weight load
- Contrasting fabric option – specify X (i.e., 39A-BWAAX). For list pricing, use your electronic specification tool or contact customer service

To Order Contrasting Fabric, Specify:

1. Model Number plus “X”
2. Back Fabric Grade Number/Cover Number
3. Seat Fabric Grade Number/Cover Number
4. Finish Designator

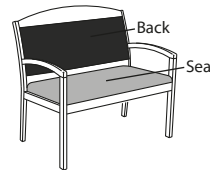

Contrasting Fabric

Ganging Center Table

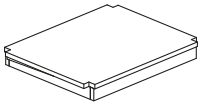

39T-SGW	Wood Top	\$ 692
39T-SGLW	Laminate Top	692

Dimensions

Width	24¾	Weight	14
Depth	19¼	Cubic Ft.	1.4
Height	22½		

- Some assembly required
- Notched to fit snugly to adjoining chairs and bariatric seating
- Fastens with L-shaped brackets under side rails of ganging chairs
- Ganging tables cannot be used with armless chairs

**Ganging
Corner Table**



**Model
No.**

Grade / List Price

39T-SHW	Wood Top	\$ 819
39T-SHLW	Laminate Top	819

Dimensions

Width	41 ²⁹ / ₃₂	Weight	25
Depth	26 ¹ / ₂	Cubic Ft.	2.7
Height	17 ⁵ / ₈		

- Some assembly required
- Notched to fit snugly to adjoining chairs and bariatric seating
- Fastens with L-shaped brackets under side rails of ganging chairs
- Ganging tables cannot be used with armless chairs

**Single Panel
Armless**



		1	2/COM	3/COL	4	6	7	L7	L8
39L-GRXX	Wood Back	\$ 629	646	655	667	704	735	883	930
39H-GRXX	Upholstered Back	637	664	676	695	753	801	1029	1102

Dimensions

				39L-GRXX		39H-GRXX	
Width	19 ¹ / ₂	Seat Height	18 ¹ / ₂	Seat Width	19 ¹ / ₂	Seat Width	19 ¹ / ₂
Depth	23	Cubic Ft.	13.4	Seat Depth	18 ¹ / ₂	Seat Depth	17
Height	35			Weight	28	Weight	30

- Contrasting fabric option – specify X (i.e., 39H-GRXXX). For list pricing, use your electronic specification tool or contact customer service

**"V" Back
Armless**



		1	2/COM	3/COL	4	6	7	L7	L8
39B-GRXX	Wood Back	\$ 629	646	655	667	704	735	883	930
39E-GRXX	Upholstered Back	637	664	676	695	753	801	1029	1102

Dimensions

				39B-GRXX		39E-GRXX	
Width	19 ¹ / ₂	Seat Height	18 ¹ / ₂	Seat Width	19 ¹ / ₂	Seat Width	19 ¹ / ₂
Depth	23	Cubic Ft.	13.4	Seat Depth	18 ¹ / ₂	Seat Depth	17
Height	35			Weight	28	Weight	30

- Contrasting fabric option – specify X (i.e., 39E-GRXXX). For list pricing, use your electronic specification tool or contact customer service

To Order Contrasting Fabric, Specify:

1. Model Number plus "X"
2. Back Fabric Grade Number/Cover Number
3. Seat Fabric Grade Number/Cover Number
4. Finish Designator

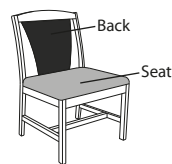

Contrasting Fabric

To Order, Specify:

1. Model Number
2. Fabric Grade Number
3. Cover Number
4. Finish Designator

• See page 417 for Timberlane options

Double Panels Armless



Model No.	Grade / List Price									
		1	2/COM	3/COL	4	6	7	L7	L8	
39D-GRXX Wood Back	\$ 637	654	663	675	712	743	891	938		
Dimensions										
Width	19½	Seat Height	18½	Seat Width	19½	Weight	28			
Depth	23	Seat Depth	18½			Cubic Ft.	13.4			
Height	35									

Full Back Armless



Model No.	Grade / List Price									
		1	2/COM	3/COL	4	6	7	L7	L8	
39U-GRXX Upholstered Back	\$ 647	674	686	705	763	811	1039	1112		
Dimensions										
Width	19½	Seat Height	18½	Seat Width	19½	Weight	30			
Depth	23	Seat Depth	17			Cubic Ft.	13.4			
Height	35									

• Contrasting fabric option – specify X (i.e., 39U-GRXXX). For list pricing, use your electronic specification tool or contact customer service

To Order Contrasting Fabric, Specify:

1. Model Number plus “X”
2. Back Fabric Grade Number/Cover Number
3. Seat Fabric Grade Number/Cover Number
4. Finish Designator

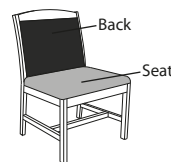

Contrasting Fabric

Slatback Armless



Model No.	Grade / List Price									
		1	2/COM	3/COL	4	6	7	L7	L8	
39S-GRXX Wood Back	\$ 675	692	701	713	750	781	929	976		
Dimensions										
Width	19½	Seat Height	18½	Seat Width	19½	Weight	28			
Depth	23	Seat Depth	18½			Cubic Ft.	13.4			
Height	35									

**¾ Back
Armless**



**Model
No.**

Grade / List Price

		1	2/COM	3/COL	4	6	7	L7	L8
39A-GRXX	Upholstered Back	\$ 638	663	675	693	748	793	1010	1079

Dimensions

Width	19½	Seat Height	18½	Seat Width	19½	Weight	30
Depth	23	Seat Depth	17			Cubic Ft.	13.4
Height	35						

- Contrasting fabric option – specify X (i.e., 39A-GRXXX). For list pricing, use your electronic specification tool or contact customer service

To Order Contrasting Fabric, Specify:

1. Model Number plus “X”
2. Back Fabric Grade Number/Cover Number
3. Seat Fabric Grade Number/Cover Number
4. Finish Designator

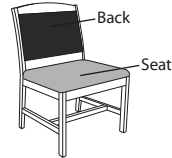

Contrasting Fabric

Metal Ganging Bracket

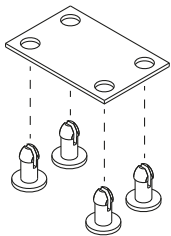

39CB	One Set	\$ 20
-------------	---------	-------

Dimensions

Weight	0.5
Cubic Ft.	0.01

- Specify model number only
- Because of differences in seat depths, Timberlane chairs can only be ganged arm to arm chair or armless to armless chair
- One set gangs two chairs
- Separates chairs by ½"

Wood Ganging Bracket

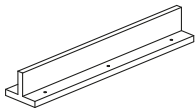

39SJ	Wood	\$ 64
-------------	------	-------

Dimensions

Width	3¾	Weight	3
Depth	17¾	Cubic Ft.	0.6
Height	2½½		

- Specify finish
- Some assembly required
- Wood bracket attaches under seat rail
- Separates chairs by ½"
- Cannot be used on armless models

Toss™ Accent Pillows Wedges and Cushions

Toss Accent Pillows

TOSS ACCENT PILLOWS PRODUCT SPECIFICATIONS 10 Series

CONSTRUCTION

Square and Rectangle

- Polyester filled insert with non-woven ticking

Bolster

- Features high grade polyurethane foam with a polyester wrap

CLOSURE

- Nylon zipper

UPHOLSTERY DETAILS

- Contrasting fabric available on all models

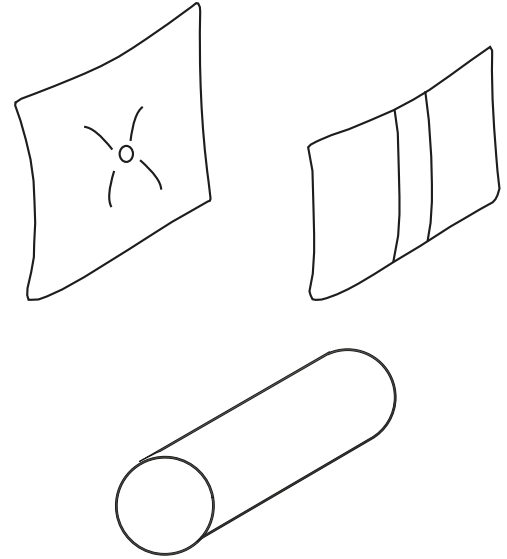

FABRICS

Grade 1 American Graffiti
 Cali
 Plush
 Ridge
 Speedway
 Stardust

Grade 2 Cathedral
 COM
 Orbit
 Pixie
 Sedona
 Shenanigans
 Spectrum
 Strand
 Tranquility
 Twilight

Grade 3 Boardwalk
 COL
 Jacks
 Pop Rocks

Grade 4 Big City
 Bumble
 Connect Four
 Echo
 Silvertex

Grade 6 Essence/Ultraleather
 Flock
 Scribe

Grade 7 Brisa
 Brisa Distressed
 Promessa
 Silica

Grade L7 Davenport

Grade L8 Showcase

Toss Accent Pillows

To Order, Specify:

1. Model Number
 2. Fabric Grade / Cover Number
- See page 429 for Toss Accent Pillows options

Bolster

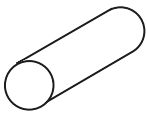

Standard Model

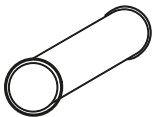

With Piping

Model No.

Grade / List Price

		1	2/COM	3/COL	4	6	7	L7	L8
N10PBL1806	18x6 Bolster	\$ 144	158	164	174	204	229	347	385
N10PBL1806P	18x6 Bolster with Piping	165	181	189	200	235	264	402	446

Weight 3.5
Cubic Ft. 1.8

- Contrasting piping only available in National fabrics and leather
- Directional fabrics are applied random and may not match from pillow to pillow

To Order Contrasting Fabric, Specify:

1. Model Number plus "X"
2. Upholstery Fabric Grade Number/Cover Number
3. Accent Fabric Grade Number/Cover Number
4. Piping Fabric Grade Number/Cover Number

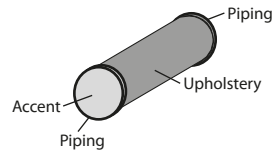

Contrasting Fabric

Square Pillow

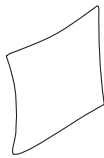

Standard Model



With Button

Model No.

Grade / List Price

		1	2/COM	3/COL	4	6	7	L7	L8
N10PSQ1414	14x14	\$ 108	122	129	139	169	194	314	353
N10PSQ1414B	14x14 Button	129	143	150	160	190	215	335	374
N10PSQ1414P	14x14 Piping	149	165	173	184	219	248	386	430
N10PSQ1414BP	14x14 Button & Piping	160	176	184	195	230	259	397	441

Weight 3.5
Cubic Ft. 1.8

- Contrasting button and piping only available in National fabrics and leather
- Directional fabrics are applied random and may not match from pillow to pillow

To Order Contrasting Fabric, Specify:

1. Model Number plus "X"
2. Upholstery Fabric Grade Number/Cover Number
3. Back Fabric Grade Number/Cover Number
4. Accent Fabric Grade Number/Cover Number
5. Piping Fabric Grade Number/Cover Number

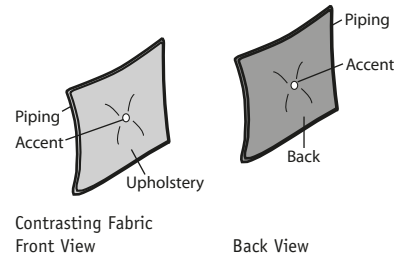

Rectangle Pillow

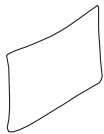

Standard Model

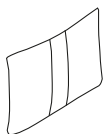

Stripe Center



Stripe Left Side with Piping (as seated)



Stripe Right Side with Piping (as seated)

		1	2/COM	3/COL	4	6	7	L7	L8
N10PRT1508	15x8	\$ 118	127	132	138	158	174	253	278
N10PRT1508L	15x8 Stripe Left	129	138	143	149	169	185	264	289
N10PRT1508R	15x8 Stripe Right	129	138	143	149	169	185	264	289
N10PRT1508C	15x8 Stripe Center	129	138	143	149	169	185	264	289
N10PRT1508P	15x8 Piping	139	151	156	164	189	210	308	340
N10PRT1508LP	15x8 Piping & Stripe Left	149	161	166	174	199	220	318	350
N10PRT1508RP	15x8 Piping & Stripe Right	149	161	166	174	199	220	318	350
N10PRT1508CP	15x8 Piping & Stripe Center	149	161	166	174	199	220	318	350

Weight 3.0
Cubic Ft. 1.8

- Contrasting piping only available in National fabrics and leather
- Right and left models are as seated
- Directional fabrics are applied random and may not match from pillow to pillow

To Order Contrasting Fabric, Specify:

1. Model Number plus "X"
2. Upholstery Fabric Grade Number/Cover Number
3. Back Fabric Grade Number/Cover Number
4. Accent Fabric Grade Number/Cover Number
5. Piping Fabric Grade Number/Cover Number

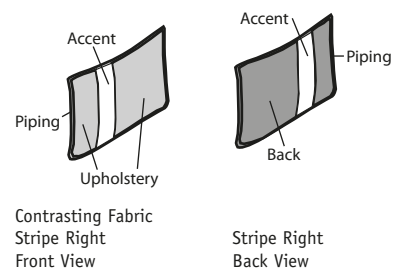

Wedges and Cushions

WEDGE AND CUSHIONS PRODUCT SPECIFICATIONS

CONSTRUCTION

Wedge

- Features high grade polyurethane foam with a ½" structural base for stability
- Contrasting fabric available

Cushions

- 1¾" high grade polyurethane foam covers a ¾" solid base panel
- Features non-skid pad

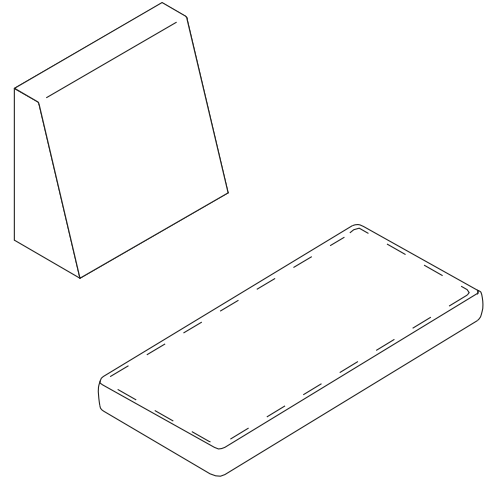

FABRICS

Grade 1 American Graffiti
Cali
Plush
Ridge
Speedway
Stardust

Grade 2 Cathedral
COM
Orbit
Pixie
Sedona
Shenanigans
Spectrum
Strand
Tranquility
Twilight

Grade 3 Boardwalk
COL
Jacks
Pop Rocks

Grade 4 Big City
Bumble
Connect Four
Echo
Silvertex

Grade 6 Essence/Ultraleather
Flock
Scribe

Grade 7 Brisa
Brisa Distressed
Promessa
Silica

Grade L7 Davenport

Grade L8 Showcase

Wedges and Cushions

To Order, Specify:

1. Model Number
2. Fabric Grade / Cover Number
- See page 433 for Wedges and Cushions options

Wedge

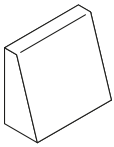

Model No.	Grade / List Price	Grade / List Price							
		1	2/COM	3/COL	4	6	7	L7	L8
N10PWD1816	18W Wedge	\$ 335	356	366	380	425	462	639	696
N10PWD2116	21W Wedge	361	386	398	416	471	516	733	802
N10PWD2416	24W Wedge	386	414	427	446	506	555	792	867

18" Weight 6.5
 21" Weight 7.0
 24" Weight 7.5
 Cubic Ft. 4.3

To Order Contrasting Fabric, Specify:

1. Model Number plus "X"
2. Upholstery Fabric Grade Number/Cover Number
3. Back Fabric Grade Number/Cover Number
4. Accent Fabric Grade Number/Cover Number

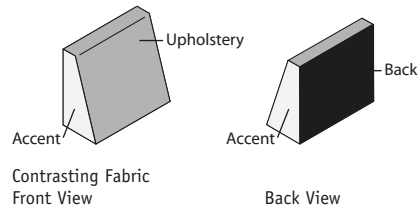

Cushion

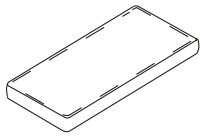

24", 30", 36" and 48"

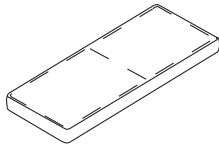

60" and 72"

Model No.

Grade / List Price

		1	2/COM	3/COL	4	6	7	L7	L8
NAC1824CUSH	18x24 Cushion	\$ 247	263	271	282	317	346	484	528
NAC1830CUSH	18x30 Cushion	263	284	294	308	353	390	567	624
NAC1836CUSH	18x36 Cushion	280	305	317	335	390	435	652	721
NAC1848CUSH	18x48 Cushion	420	443	454	470	520	561	758	821
NAC1860CUSH	18x60 Cushion	527	564	581	607	687	753	1068	1169
NAC1872CUSH	18x72 Cushion	604	643	662	689	774	844	1179	1286
NAC2124CUSH	21x24 Cushion	247	263	271	282	317	346	484	528
NAC2130CUSH	21x30 Cushion	263	286	297	313	363	404	601	664
NAC2136CUSH	21x36 Cushion	280	305	317	335	390	435	652	721
NAC2148CUSH	21x48 Cushion	490	515	527	545	600	645	862	931
NAC2160CUSH	21x60 Cushion	595	636	656	685	775	849	1203	1317
NAC2172CUSH	21x72 Cushion	694	738	759	789	884	962	1336	1456
NAC2424CUSH	24x24 Cushion	247	265	274	287	327	360	517	568
NAC2430CUSH	24x30 Cushion	263	291	304	323	383	432	669	744
NAC2436CUSH	24x36 Cushion	280	308	321	340	400	449	686	761
NAC2448CUSH	24x48 Cushion	511	539	552	571	631	680	917	992
NAC2460CUSH	24x60 Cushion	641	689	712	746	851	937	1351	1483
NAC2472CUSH	24x72 Cushion	735	783	806	840	945	1031	1445	1577

	Weight	Cubes
18x24	10	1.9
18x30	12.5	1.9
18x36	15	1.9
18x48	20	2.6
18x60	25	3.8
18x72	29	3.8
21x24	11	2.0
21x30	14	2.0
21x36	16.5	2.0
21x48	22	2.6
21x60	28	3.8
21x72	32	3.8
24x24	12	2.0
24x30	15	2.0
24x36	18	2.0
24x48	24	2.6
24x60	31	3.8
24x72	35	3.8

Triumph™

Triumph

TRIUMPH PRODUCT SPECIFICATIONS

88/89 Series

FRAME CONSTRUCTION (88 SERIES)

- 88X-GMXX and 88X-GRXX features a one piece metal tube frame for structural stability
- Polyurethane arm caps are standard to enhance comfort

(89 SERIES)

- All joints are double doweled and securely glued for maximum joint stability
- 89X-GWXX features a metal seat frame for added strength
- Non-marring nylon glides

SEAT CONSTRUCTION

- Blow molded polyethylene seat or solid molded plywood panels that are covered with high grade polyurethane foam

BACK CONSTRUCTION

- Solid molded plywood panels are covered with 1½" of high grade polyurethane foam
- 88X-ENFXC, 88X-MNFXC and 88X-MRFXC models feature a J-bar mechanism, which allows the back to flex, providing continuous support as the user moves

ARMS (89 SERIES)

- Arms are made of kiln dried exterior northern hard maple and are attached to the seat with bolts and to the back with a fastener
- Arms on the 89X-EWECC and 89X-MWECC have a protective polyurethane arm cap

ARMS (UPHOLSTERED)

- Arms are made of fiberboard covered with high density polyurethane foam

ARMS (88 SERIES)

- Arms on the 88X-ENFXC and 88X-MNFXC are molded nylon with a polyurethane cap

CONTROL MECHANISM/LIFT

- The standard knee tilt mechanism features a heavy-duty adjustable tension spring for a variety of body sizes and minimal rise of front seat edge; this allows user's feet to remain planted when chair is in reclining position
- The combination gas lift/tilt lock lever allows dual function with simple in/out movement for lockout and up/down movement for height adjustment

BASE AND CASTERS

- Nylon base features standard black five-prong fiberglass reinforced nylon to ensure long life
- Wood base features a standard five-prong, rigid steel understructure to ensure a long life
- Caster posts fit directly into steel sleeves, greatly reducing caster socket failure
- Decorative hardwood caps complement the chair design
- Both wood and nylon bases have black, hard double wheel casters, which work on multiple surfaces
- Black, soft double wheel casters are available for use on hard floors; upcharge applies to this option
- All National bases are tested to BIFMA standards using 2500 lb. force

JURY BASE

- Pneumatic jury base
- Memory return swivel



FINISH

- Wood models feature a catalyzed top coat resists denting, peeling and reactions to chemicals
- Can be cleaned with a damp cloth
- Features our silver ion antimicrobial finish which inhibits the growth of bacteria and microbes

WOOD SPECIES

- Hard maple

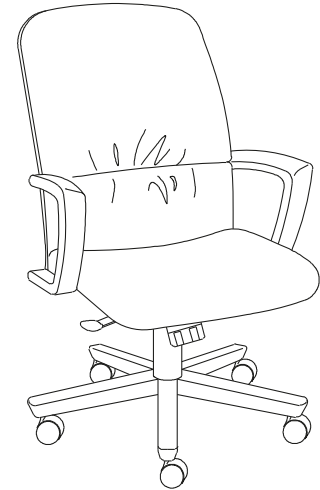

All Triumph models may be ordered to meet TB133 fire code.

To order seating to meet the TB133 fire code, specify an "F" at the end of the model number (Ex: 88X-ENFXCF).

Reference pages 465-493 for TB133 Fabric Matrix and pricing.

Please consult customer service for applicable Arc-Com, COM, Maharam, Momentum, Stinson or Ultrafabrics fabric.



FABRICS

Grade 1	American Graffiti
	Cali
	Plush
	Ridge
	Speedway
Grade 2	Stardust
	Cathedral
	COM
	Orbit
	Pixie
	Sedona
	Shenanigans
	Spectrum
	Strand
Tranquility	
Twilight	

Grade 3	Boardwalk
	COL
	Jacks
	Pop Rocks

Grade 4	Big City
	Bumble
	Connect Four
	Echo
Silvertex	

Grade 6	Essence/Ultraleather
	Flock
	Scribe

Grade 7	Brisa
	Brisa Distressed
	Promessa
	Silica

Grade L7 Davenport

Grade L8 Showcase

89 SERIES

FINISHES

IM Brighton	CW Cordovan
NM Natural	DW Judicial
HN Honey	MH Mocha
CL Caramel	405 Designer White
TF Truffle	462 Cinder
AC Autumn	792 Sable
MC Amber	793 Acorn

CASTERS

For Wood Base

C3	Hard (standard)
C4	Soft (add \$24 list)

For Plastic Base

C16	Hard (standard)
C2	Soft (add \$24 list)

88 SERIES

FINISHES

Standard Black

LAMINATES

HN2	Honey 2
461	Graphite

CASTERS

C16	Hard (standard)
C2	Soft (add \$24 list)

Triumph

To You In
10 DAYS
...or Less

Shaded model numbers are available on our "To You in 10 Days or Less" Quick Delivery program and will be delivered within 10 days.

To Order, Specify:

1. Model Number
2. Fabric Grade Number
3. Cover Number
4. Finish Designator
5. Casters

• See page 439 for Triumph options

High Back Wood Arm



Model No.	Grade / List Price									
		1	2/COM	3/COL	4	6	7	L7	L8	
89X-EWEXC Wood Base	\$	1134	1175	1195	1224	1314	1388	1742	1856	
89X-EWEXCJ Jury Base		1359	1400	1420	1449	1539	1613	1967	2081	
Dimensions										
Width	26¼	Arm Height	25½-31½	Seat Width	20½	Weight	58			
Depth	28	Seat Height	17-22½			Cubic Ft.	17.4			
Height	39¼-45¼	Seat Depth	17½							

High Back Wood Arm with Polyurethane Arm Caps



Quick Delivery Model: Q89X-EWECC

Model No.	Grade / List Price									
		1	2/COM	3/COL	4	6	7	L7	L8	
89X-EWECC Wood Base	\$	1194	1235	1255	1284	1374	1448	1802	1916	
89X-EWECCJ Jury Base		1419	1460	1480	1509	1599	1673	2027	2141	
Dimensions										
Width	26¼	Arm Height	25½-31½	Seat Width	20½	Weight	58			
Depth	28	Seat Height	17-22½			Cubic Ft.	17.4			
Height	39¼-45¼	Seat Depth	17½							

Low Back Wood Arm



Model No.	Grade / List Price									
		1	2/COM	3/COL	4	6	7	L7	L8	
89X-MWEXC Wood Base	\$	1105	1142	1159	1185	1265	1331	1646	1747	
89X-MWEXCJ Jury Base		1330	1367	1384	1410	1490	1556	1871	1972	
Dimensions										
Width	26¼	Arm Height	25½-31½	Seat Width	20½	Weight	57			
Depth	26	Seat Height	17-22½			Cubic Ft.	15.5			
Height	34¼-40¼	Seat Depth	17½							

**Low Back
Wood Arm with
Polyurethane Arm Caps**



**Model
No.**

Grade / List Price

Quick Delivery Model: Q89X-MWECC

		1	2/COM	3/COL	4	6	7	L7	L8
89X-MWECC	Wood Base	\$ 1165	1202	1219	1245	1325	1391	1706	1807
89X-MWECCJ	Jury Base	1390	1427	1444	1470	1550	1616	1931	2032

Dimensions

Width	26¼	Arm Height	25½-31½	Seat Width	20½	Weight	57
Depth	26	Seat Height	17-22½	Cubic Ft.			15.5
Height	34¼-40¼	Seat Depth	17½				

**High Back
Fully Upholstered Arm**



		1	2/COM	3/COL	4	6	7	L7	L8
89X-EUEXC	Wood Base	\$ 1036	1085	1109	1144	1251	1339	1763	1898
89X-EUFXC	Plastic Base	957	1006	1030	1065	1172	1260	1684	1819
89X-EUFXCJ	Jury Base	1182	1231	1255	1290	1397	1485	1909	2044

Dimensions

Width	26¼	Arm Height	25½-31½	Seat Width	20½	89X-EUEXC	
Depth	28	Seat Height	17-22½	Cubic Ft.	17.4	Weight	64
Height	39¼-45¼	Seat Depth	17½			89X-EUFXC	
						Weight	56

**Low Back
Fully Upholstered Arm**



		1	2/COM	3/COL	4	6	7	L7	L8
89X-MUEXC	Wood Base	\$ 1011	1057	1079	1111	1211	1293	1687	1813
89X-MUFXC	Plastic Base	932	978	1000	1032	1132	1214	1608	1734
89X-MUFXCJ	Jury Base	1157	1203	1225	1257	1357	1439	1833	1959

Dimensions

Width	26¼	Arm Height	25½-31½	Seat Width	20½	89X-MUEX	
Depth	28	Seat Height	17-22½	Cubic Ft.	15.5	Weight	63
Height	34¼-40¼	Seat Depth	17½			89X-MUFX	
						Weight	55

Guest



Quick Delivery Model: Q89X-GWXX

		1	2/COM	3/COL	4	6	7	L7	L8
89X-GWXX	Wood Frame	\$ 742	777	793	817	892	954	1249	1344

Dimensions

Width	24½	Arm Height	26½	Seat Width	20½	Weight	32
Depth	25	Seat Height	17½	Cubic Ft.			13.4
Height	34	Seat Depth	19				

Triumph

To You In
10
DAYS
...or Less

Shaded model numbers are available on our "To You in 10 Days or Less" Quick Delivery program and will be delivered within 10 days.

To Order, Specify:

1. Model Number
2. Fabric Grade Number
3. Cover Number
4. Finish Designator
5. Casters

• See page 439 for Triumph options

High Back Nylon Arm



Model No.

Grade / List Price

DISCONTINUED - 12/31/16

	1	2/COM	3/COL	4	6	7	L7	L8
88X-ENFXC Plastic Base	\$ 848	885	904	931	1013	1081	1406	1509
88X-ENFXCJ Jury Base	1066	1103	1122	1149	1231	1290	1624	1727

Dimensions

Width	26½	Arm Height	26-31¼	Seat Width	20¾	Weight	41
Depth	25	Seat Height	16¾-21¾			Cubic Ft.	19.0
Height	37-42¼	Seat Depth	17¼				

Low Back Nylon Arm



Quick Delivery Model: Q88X-MNFXC

DISCONTINUED - 12/31/16

	1	2/COM	3/COL	4	6	7	L7	L8
88X-MNFXC Plastic Base	\$ 824	857	874	898	970	1030	1316	1408
88X-MNFXCJ Jury Base	1042	1075	1092	1116	1188	1248	1534	1626

Dimensions

Width	26½	Arm Height	26-31¼	Seat Width	20¾	Weight	40
Depth	25	Seat Height	16¾-21¾			Cubic Ft.	15.5
Height	33¼-38½	Seat Depth	17¼				

Low Back Armless



DISCONTINUED - 12/31/16

	1	2/COM	3/COL	4	6	7	L7	L8
88X-MRFXC Plastic Base	\$ 731	764	781	805	877	937	1223	1315
88X-MRFXCJ Jury Base	949	982	999	1023	1095	1155	1441	1533

Dimensions

Width	26½	Seat Height	16¾-21¾	Seat Width	20¾	Weight	38
Depth	25	Seat Depth	17¼			Cubic Ft.	15.5
Height	33¼-38½						

Guest Gangable

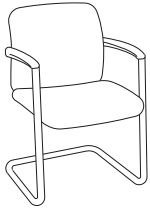

Model No.

DISCONTINUED - 12/31/16

Grade / List Price

		1	2/COM	3/COL	4	6	7	L7	L8
88X-GMXX	Metal Frame	\$ 587	620	637	661	733	793	1079	1171

Dimensions

Width	23¼	Arm Height	26	Seat Width	20½	Weight	38
Depth	24¼	Seat Height	17¾			Cubic Ft.	13.4
Height	32¾	Seat Depth	17¾				

Guest Gangable

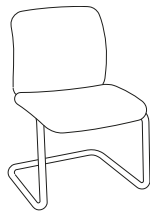

DISCONTINUED - 12/31/16

		1	2/COM	3/COL	4	6	7	L7	L8
88X-GRXX	Metal Frame	\$ 559	592	609	633	705	765	1051	1143

Dimensions

Width	23¾	Seat Height	17¾	Seat Width	21¾	Weight	33
Depth	24¼	Seat Depth	17¾			Cubic Ft.	13.4
Height	33¾						

Ganging Bracket

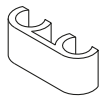

DISCONTINUED - 12/31/16

N88CB	Black	\$ 22							
------------------	------------------	------------------	--	--	--	--	--	--	--

Dimensions

Width	3¾	Depth	1½	Height	1¼	Weight	1
						Cubic Ft.	0.01

- Specify model number only
- Sold in quantities of (2) per set
- Two ganging brackets are recommended for each ganged connection
- When ganging brackets are purchased on the same order with chairs, the brackets will be attached underneath the seats
- Ganging bracket may also serve as a glide for ganged connections by turning the flat side of the bracket towards the floor

Glide

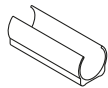

DISCONTINUED - 12/31/16

N88GL	Clear	\$ 24							
------------------	------------------	------------------	--	--	--	--	--	--	--

Dimensions

Width	1¾	Depth	2	Height	1	Weight	1
						Cubic Ft.	0.01

- Specify model number only
- Sold in quantities of (4) per set
- Adhesive tape is applied to each glide for secure attachment to the frame

Recommended Glide Placement

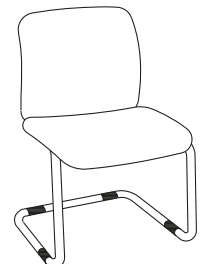

To Order, Specify:

1. Model Number
 2. Laminate Number
- See page 439 for Triumph options

**Corner Table
Gangable**



Model No. **List Price**

DISCONTINUED - 12/31/16

~~88-3333TP Laminate Top \$ 722~~

Dimensions

Width	32¾	Depth	32¾	Height	17½	Weight Cubic Ft.	52 5.85
-------	-----	-------	-----	--------	-----	---------------------	------------

- Two ganging brackets are recommended for each ganged connection
- Black edge banding is standard on the table tops

**Center/End Table
Gangable**

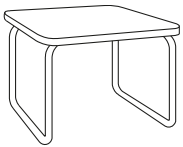

DISCONTINUED - 12/31/16

~~88-2424TP Laminate Top \$ 559~~

Dimensions

Width	23¾	Depth	23¾	Height	17½	Weight Cubic Ft.	40 2.95
-------	-----	-------	-----	--------	-----	---------------------	------------

- Two ganging brackets are recommended for each ganged connection
- Black edge banding is standard on the table tops

Wander™

Wander

WANDER PRODUCT SPECIFICATIONS

N22 Series

SEAT CONSTRUCTION

- 2" of polyurethane foam covers a 12 mm cross-banded plywood seat panel

BACK CONSTRUCTION

- Injection molded inner and outer shell

MESH

- 100% polyester
- Cleaning code W

LUMBAR

- Standard in all models, features a polyurethane foam pad

ARM AND ARM PADS

- Encased uprights are made of reinforced glass filled nylon
- Feature soft polyurethane arm pads

CONTROL

- Synchronous control features adjustable tension and upright back lock
- Standard pneumatic gas cylinder lift allows seat to raise and lower 5½"

BASE AND CASTERS

- Black nylon five prong base features glass filled nylon for beauty and long life
- Black, 50 mm hard double wheel hooded casters, which work on multiple surfaces, are standard
- Black, 50 mm soft double wheel non-hooded casters, for use on hard surfaces, are available at an upcharge

- Ships KD



For comprehensive sustainability information that includes LEED® point contribution, visit NationalOfficeFurniture.ecoScorecard.com.

FABRICS

Grade 1	American Graffiti
	Cali
	Plush
	Ridge
	Speedway
Grade 2	Stardust
	Cathedral
	COM
	Orbit
	Pixie
	Sedona
	Shenanigans
	Spectrum
Strand	
Tranquility	
Twilight	

Grade 3	Boardwalk
	COL
	Jacks
	Pop Rocks

Grade 4	Big City
	Bumble
	Connect Four
	Echo
Silvertex	

Grade 6	Essence/Ultraleather
	Flock
	Scribe

Grade 7	Brisa
	Brisa Distressed
	Promessa
	Silica

Grade L7	Davenport
----------	-----------

Grade L8	Showcase
----------	----------

CASTERS

STD	Hard (standard)
C2	Soft (add \$24 list)

To You In
10 DAYS
...or Less

Shaded model numbers are available on our "To You in 10 Days or Less" Quick Delivery program and will be delivered within 10 days.

To Order, Specify:

1. Model Number
 2. Seat Fabric Grade Number / Cover Number (when applicable)
 3. Casters
- See page 447 for Wander options

Armless



Model No.

Grade / List Price

Quick Delivery Model: QN22HMM

	1	2/COM	3/COL	4	6	7	L7	L8
N22HMM	\$ 644	665	675	689	734	771	948	1005

Dimensions

Width	26½	Seat Height	15¼-20¾	Back Height	21¾	Weight	40
Depth	26½	Seat Depth	17½	Back Width	18½	Cubic Ft.	8.5
Height	36½-42	Seat Width	19				

- Some assembly required, tool included

Arm



Quick Delivery Model: QN22HMA

	1	2/COM	3/COL	4	6	7	L7	L8
N22HMA	\$ 705	726	736	750	795	832	1009	1066

Dimensions

Width	26½	Seat Height	15¼-20¾	Arm Height	23¾-26½	Weight	40
Depth	26½	Seat Depth	17½	Back Height	21¾	Cubic Ft.	8.5
Height	36½-42	Seat Width	19	Back Width	18½		

- Some assembly required, tool included

Arm



Quick Delivery Model: QN22HMAB

N22HMAB	Black Mesh, Black Seat Only	\$ 584
----------------	-----------------------------	---------------

Dimensions

Width	26½	Seat Height	15¼-20¾	Arm Height	23¾-26½	Weight	40
Depth	26½	Seat Depth	17½	Back Height	21¾	Cubic Ft.	8.5
Height	36½-42	Seat Width	19	Back Width	18½		

- Some assembly required, tool included
- For soft casters, contact customer service
- Seat fabric is 100% polyester

Whimsy®

Whimsy

WHIMSY PRODUCT SPECIFICATIONS

66 Series

BOX CONSTRUCTION

- Foam structure with $\frac{3}{4}$ " wood base
- Features $3\frac{3}{8}$ " of high grade polyurethane foam seat

CONTRASTING FABRICS

- Contrasting fabrics available on all models

CASTERS

- Black, double wheel, roll control casters are standard and work on all floors

GLIDES

- Black, hard and soft combination glides are standard

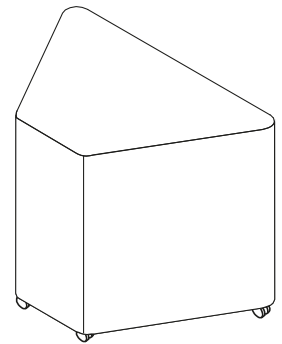
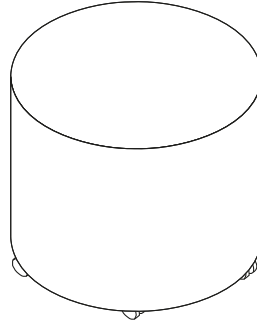
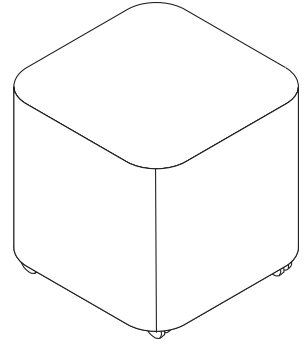

All Whimsy models may be ordered to meet TB133 fire code.

To order seating to meet the TB133 fire code, specify an "F" at the end of the model number (Ex: N66RD18GF).

Reference pages 465-493 for TB133 Fabric Matrix and pricing.

Please consult customer service for applicable Arc-Com, COM, Maharam, Momentum, Stinson or Ultrafabrics fabric.



For comprehensive sustainability information that includes LEED® point contribution, visit NationalOfficeFurniture.ecoScorecard.com.

FABRICS

Grade 1 American Graffiti
Cali
Plush
Ridge
Speedway
Stardust

Grade 2 Cathedral
COM
Orbit
Pixie
Sedona
Shenanigans
Spectrum
Strand
Tranquility
Twilight

Grade 3 Boardwalk
COL
Jacks
Pop Rocks

Grade 4 Big City
Bumble
Connect Four
Echo
Silvertex

Grade 6 Essence/Ultraleather
Flock
Scribe

Grade 7 Brisa
Brisa Distressed
Promessa
Silica

Grade L7 Davenport

Grade L8 Showcase

To You In
10
DAYS
...or Less

Shaded model numbers are available on our "To You in 10 Days or Less" Quick Delivery program and will be delivered within 10 days.

To Order, Specify:

1. Model Number
2. Fabric Grade / Cover Number
- See page 451 for Whimsy options

16" Round

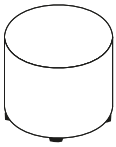

Static

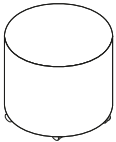

Mobile

Model No. Grade / List Price

Quick Delivery Models: QN66RD16G, QN66RD16C

		1	2	3	4	6	7	L7	L8
N66RD16G	Static	\$ 464	489	501	519	574	619	836	905
N66RD16C	Mobile	484	509	521	539	594	639	856	925

Dimensions

Width 16
Depth 16
Static Height 16
Mobile Height 16¼

Weight 11
Cubic Ft. 4.1

- Features three vertical seams
- Contrasting fabric option – specify X (i.e., N66RD16GX); see next page. For list pricing, use your electronic specification tool or contact customer service

18" Round

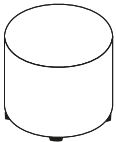

Static

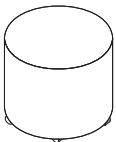

Mobile

Quick Delivery Models: QN66RD18G, QN66RD18C

		1	2/COM	3/COL	4	6	7	L7	L8
N66RD18G	Static	\$ 510	537	550	570	629	678	912	987
N66RD18C	Mobile	530	557	570	590	649	698	932	1007

Dimensions

Width 18½
Depth 18½
Static Height 17¾
Mobile Height 18¾

Weight 16
Cubic Ft. 7.3

- Features three vertical seams

To Order Contrasting Fabric, Specify:

1. Model Number plus "X"
2. Seat Fabric Grade Number/Cover Number
3. Upholstery Fabric Grade Number/Cover Number

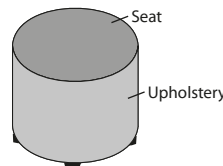

Contrasting Fabric

22" Round

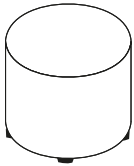

Static

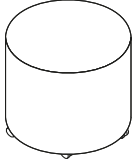

Mobile

Model No.

Grade / List Price

Quick Delivery Models: QN66RD22G, QN66RD22C

			1	2/COM	3/COL	4	6	7	L7	L8
N66RD22G	Static	\$	551	581	596	617	682	736	994	1076
N66RD22C	Mobile		572	602	617	638	703	757	1015	1097

Dimensions

Width	22¾	Weight	20
Depth	22¾	Cubic Ft.	7.3
Static Height	17¾		
Mobile Height	18¾		

- Features three vertical seams

16" Square

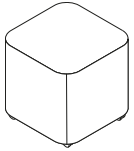

Static

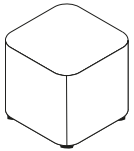

Mobile

Quick Delivery Models: QN66SQ16G, QN66SQ16C

			1	2	3	4	6	7	L7	L8
N66SQ16G	Static	\$	489	514	526	544	599	644	861	930
N66SQ16C	Mobile		510	535	547	565	620	665	882	951

Dimensions

Width	16	Weight	13
Depth	16	Cubic Ft.	4.1
Static Height	16		
Mobile Height	16¼		

- Contrasting fabric option – specify X (i.e., N66SQ16GX); see next page. For list pricing, use your electronic specification tool or contact customer service

18" Square

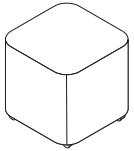

Static

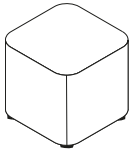

Mobile

Quick Delivery Models: QN66SQ18G, QN66SQ18C

			1	2/COM	3/COL	4	6	7	L7	L8
N66SQ18G	Static	\$	530	572	592	621	711	785	1142	1256
N66SQ18C	Mobile		551	593	613	642	732	806	1163	1277

Dimensions

Width	18¾	Weight	19
Depth	18¾	Cubic Ft.	7.3
Static Height	17¾		
Mobile Height	18¾		

To Order Contrasting Fabric, Specify:

1. Model Number plus "X"
2. Seat Fabric Grade Number/Cover Number
3. Upholstery Fabric Grade Number/Cover Number

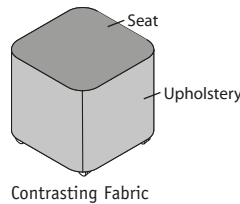

**To You In
10 DAYS
...or Less**

Shaded model numbers are available on our "To You in 10 Days or Less" Quick Delivery program and will be delivered within 10 days.

To Order, Specify:

1. Model Number
2. Fabric Grade / Cover Number
- See page 451 for Whimsy options

Whimsy

22" Square

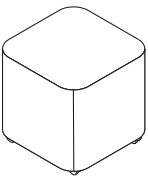

Static

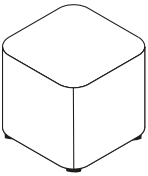

Mobile

Model No.

Grade / List Price

Quick Delivery Models: QN66SQ22G, QN66SQ22C

		1	2/COM	3/COL	4	6	7	L7	L8
N66SQ22G	Static	\$ 572	615	636	667	761	838	1211	1330
N66SQ22C	Mobile	592	635	656	687	781	858	1231	1350

Dimensions

Width 21¾
 Depth 21¾
 Static Height 17¾
 Mobile Height 18¾

Weight 22
 Cubic Ft. 7.3

To Order Contrasting Fabric, Specify:

1. Model Number plus "X"
2. Seat Fabric Grade Number/Cover Number
3. Upholstery Fabric Grade Number/Cover Number

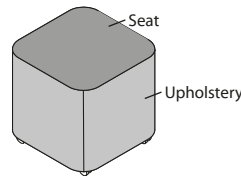

Contrasting Fabric

16" Trapezoid

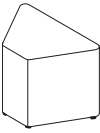

Static

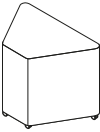

Mobile

Model No. **Grade / List Price**

Quick Delivery Models: QN66TZ16G, QN66TZ16C

		1	2	3	4	6	7	L7	L8
N66TZ16G	Static	\$ 572	595	606	622	672	713	910	973
N66TZ16C	Mobile	592	615	626	642	692	733	930	993

Dimensions

Width	21½	Weight	13
Depth	14	Cubic Ft.	4.1
Static Height	15¾		
Mobile Height	16		

- Contrasting fabric option – specify X (i.e., N66TZ16GX); see below. For list pricing, use your electronic specification tool or contact customer service

18" Trapezoid

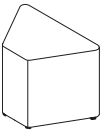

Static

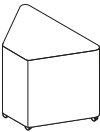

Mobile

Quick Delivery Models: QN66TZ18G, QN66TZ18C

		1	2	3	4	6	7	L7	L8
N66TZ18G	Static	\$ 654	679	691	709	764	809	1026	1095
N66TZ18C	Mobile	675	700	712	730	785	830	1047	1116

Dimensions

Width	24½	Weight	19
Depth	16½	Cubic Ft.	7.3
Static Height	17¾		
Mobile Height	18		

- Contrasting fabric option – specify X (i.e., N66TZ18GX); see below. For list pricing, use your electronic specification tool or contact customer service

22" Trapezoid

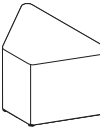

Static

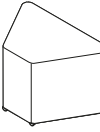

Mobile

Quick Delivery Models: QN66TZ22G, QN66TZ22C

		1	2	3	4	6	7	L7	L8
N66TZ22G	Static	\$ 695	727	743	765	835	892	1168	1256
N66TZ22C	Mobile	716	748	764	786	856	913	1189	1277

Dimensions

Width	29¼	Weight	22
Depth	19	Cubic Ft.	7.3
Static Height	17¾		
Mobile Height	18		

- Contrasting fabric option – specify X (i.e., N66TZ22GX); see below. For list pricing, use your electronic specification tool or contact customer service

To Order Contrasting Fabric, Specify:

1. Model Number plus "X"
2. Seat Fabric Grade Number/Cover Number
3. Upholstery Fabric Grade Number/Cover Number

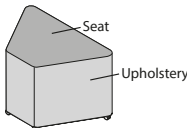

Contrasting Fabric

Power/Data Electrical

Power/Data Electrical

POWER/DATA ELECTRICAL SPECIFICATIONS

ONE TOUCH PIVOTING POWER GROMMET (G12 AND G122)

- Field installable
- One touch door remains open during use
- Clear or black anodized aluminum
- (G12) Two power outlets and two blank ports can accommodate one of eight provided adapter plates
- (G122) Two power outlets, one port with two charging USB, and one blank port that can accommodate one of eight provided adapter plates
- Hardwire solution must be ordered separately and installed in the field – top should be ordered with CUT-G12C option
- Specify model number only
- Standard units have 10 ft. cords and hardwire cords have 6 ft. cords
- UL Listed
- For use in tables only

ONE TOUCH PIVOTING POWER GROMMET (G17, G172, G173)

- Field installable
- One touch door remains open during use
- Die-cast zinc in black or silver powder coat
- (G17) Includes one power outlet and one blank voice/data port
- (G172) Includes two power outlets
- (G173) Includes one power outlet and two charging USB (2.1)
- 10 foot, 15 Amp cord
- Includes a voice/adaptor kit to accept couplers and jacks when required
- UL Listed
- For use in tables only

POWER GROMMET (G23)

- Field installable in tables when CUT-G23 option is specified
- Die-cast zinc in black or silver powder coat
- Includes two power outlets and two power USB ports
- 9 foot, 15 Amp cord
- ETL listed to UL962A Standard
- For use in tables only

To Order, Specify:

1. Model Number

One Touch Pivoting Power Grommet (G12)

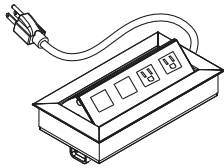

Model No. List Price

NACG12ELS	Clear Anodized Aluminum	\$ 421
NACG12ELB	Black	421
NACG12ELHS	Hardwire, Clear Anodized Aluminum	421
NACG12ELHB	Hardwire, Black	421

Dimensions

Width	8¾	Weight	2
Depth	4¾	Cubic Ft.	0.2
Height	1½		

One Touch Pivoting Power Grommet (G122)

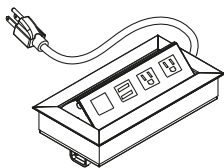

NACG122ELS	Clear Anodized Aluminum	\$ 525
NACG122ELB	Black	525
NACG122ELHS	Hardwire, Clear Anodized Aluminum	525
NACG122ELHB	Hardwire, Black	525

Dimensions

Width	8¾	Weight	2
Depth	4¾	Cubic Ft.	0.2
Height	1½		

Power/Data Electrical

To Order, Specify:

1. Model Number

One Touch Pivoting Power Grommet (G17)

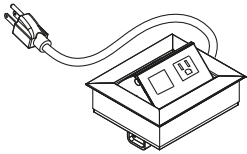

Model No. **List Price**

NACG17ELB	Black Powder Coat	\$ 293
NACG17ELS	Silver Powder Coat	293

Dimensions

Width	5¼	Weight	1.0
Depth	4¼	Cubic Ft.	0.2
Height	2½		

- Includes one power outlet and one blank voice/data port

One Touch Pivoting Power Grommet (G172)

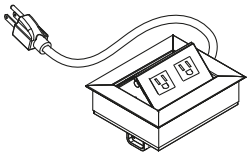

NACG172ELB	Black Powder Coat	\$ 298
NACG172ELS	Silver Powder Coat	298

Dimensions

Width	5¼	Weight	3.0
Depth	4¼	Cubic Ft.	0.15
Height	2½		

- Includes two power outlets

One Touch Pivoting Power Grommet (G173)

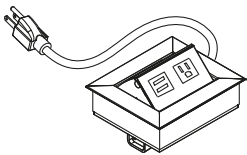

NACG173ELB	Black Powder Coat	\$ 305
NACG173ELS	Silver Powder Coat	305

Dimensions

Width	5¼	Weight	3.0
Depth	4¼	Cubic Ft.	0.15
Height	2½		

- Includes one power outlet and two charging USB (2.1)

Power Grommet (G23)

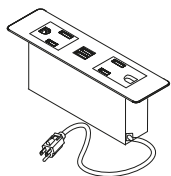

NACG23ELB	Black	\$ 431
NACG23ELS	Silver	431

Dimensions

Width	4½	Weight	2.3
Depth	2½	Cubic Ft.	0.2
Height	3¼		

- Includes two power outlets and two power USB ports

National Seating Fabric TB133 Matrix

•TB133 available
 xTB133 available on select models, contact customer service for models
 ≠TB133 not available

National Chairs		National Seating Fabrics																																							
		Grade	1	4	3	7	7	4	2	4	L7	4	6	6	3	2	2	1	3	7	1	6	2	2	L8	7	4	2	1	1	2	2	2								
		American Graffiti	Big City	Boardwalk	Brisa	Brisa Distressed	Bumble	Cathedral	Connect Four	Davenport	Echo	Essence/Ultraleather	Flock	Jacks	Orbit	Pixie	Plush	Pop Rocks	Promessa	Ridge	Scribe	Sedona	Shenanigans	Showcase	Silica	Silvertex	Spectrum	Speedway	Stardust	Strand	Tranquility	Twilight									
Acquaint	N59	•	•	•	•	•	•	•	•	•	•	•	•	•	•	≠	•	•	•	•	•	•	•	•	•	•	•	•	•	•	•	•	•	•							
Admire	N55	•	•	•	•	•	•	•	•	•	•	•	•	•	•	≠	•	•	•	•	•	•	•	•	•	•	•	•	•	•	•	•	•	•	•						
Arlington	45, 48, 64, 72	•	•	•	x	x	•	•	x	•	•	x	•	•	•	≠	•	•	x	•	x	x	•	•	•	x	•	x	•	•	•	•	•	•	•						
Aurora	N65	•	•	•	•	•	•	•	•	•	•	•	•	•	•	≠	•	•	•	•	•	•	•	•	•	•	•	•	•	•	•	•	•	•	•	•					
Cinch	N45	•	•	•	•	•	•	•	•	•	•	•	•	•	•	≠	•	•	•	•	•	•	•	•	•	•	•	•	•	•	•	•	•	•	•	•					
Confide Guest	N78	•	•	•	x	x	•	•	x	•	•	x	•	•	•	≠	•	•	x	•	x	x	•	•	•	x	•	x	•	•	•	•	•	•	•	•					
Confide Lounge	N78	•	•	•	≠	≠	•	•	≠	•	•	≠	•	•	•	≠	•	•	≠	•	≠	≠	•	•	•	≠	•	≠	•	≠	•	•	•	•	•	•					
Davari	N48	•	•	•	•	•	•	•	•	•	•	•	•	•	•	≠	•	•	•	•	•	•	•	•	•	•	•	•	•	•	•	•	•	•	•	•	•				
Eloquence	N85	•	•	•	x	x	•	•	x	•	•	x	•	•	•	≠	•	•	x	•	x	x	•	•	•	x	•	x	•	•	•	•	•	•	•	•					
Fringe	N92	•	•	•	≠	≠	•	•	≠	•	•	•	•	•	•	≠	•	•	≠	•	≠	≠	•	•	•	≠	•	≠	•	≠	•	•	•	•	•	•	•				
Fuel	N35	•	•	•	•	•	•	•	•	•	•	•	•	•	•	≠	•	•	•	•	•	•	•	•	•	•	•	•	•	•	•	•	•	•	•	•	•				
Gotcha	N23, N24 N25, N26	•	•	•	•	•	•	•	•	•	•	•	•	•	•	≠	•	•	•	•	•	•	•	•	•	•	•	•	•	•	•	•	•	•	•	•	•	•			
Jiminy	N52	•	•	•	•	•	•	•	•	•	•	•	•	•	•	≠	•	•	•	•	•	•	•	•	•	•	•	•	•	•	•	•	•	•	•	•	•	•			
Lavoro (non-mesh)	N30	•	•	•	≠	≠	•	•	≠	•	•	•	•	•	•	≠	•	•	≠	•	≠	≠	•	•	•	≠	•	≠	•	≠	•	•	•	•	•	•	•	•			
Medalist	N67, N68, N69	•	•	•	≠	≠	•	•	≠	•	•	≠	•	•	•	≠	•	•	≠	•	≠	≠	•	•	•	≠	•	≠	•	≠	•	•	•	•	•	•	•	•			
Mix-it	N12, N13, N14	•	•	•	≠	•	•	•	•	•	•	•	•	•	•	≠	•	•	•	•	•	•	•	•	•	•	•	•	•	•	•	•	•	•	•	•	•	•	•		
Mix-it Mesh	N15, N16, N17	•	•	•	•	•	•	•	•	•	•	•	•	•	•	≠	•	•	•	•	•	•	•	•	•	•	•	•	•	•	•	•	•	•	•	•	•	•	•		
Monterrey	N90	•	•	•	≠	≠	•	•	≠	•	•	≠	•	•	•	≠	•	•	≠	•	≠	≠	•	•	•	≠	•	≠	•	≠	•	•	•	•	•	•	•	•	•		
Pennant	62X	•	•	•	≠	≠	•	•	≠	•	•	•	•	•	•	≠	•	•	•	•	•	•	•	•	•	•	•	•	•	•	•	•	•	•	•	•	•	•	•		
Remedy	N79	•	•	•	•	•	•	•	•	•	•	•	•	•	•	≠	•	•	•	•	•	•	•	•	•	•	•	•	•	•	•	•	•	•	•	•	•	•	•	•	
Reno	N32	•	•	•	x	x	•	•	x	•	•	x	•	•	•	≠	•	•	≠	•	•	x	•	•	•	x	•	≠	•	•	•	•	•	•	•	•	•	•	•	•	
Respect	N75	•	•	•	•	•	•	•	•	•	•	•	•	•	•	≠	•	•	•	•	•	•	•	•	•	•	•	•	•	•	•	•	•	•	•	•	•	•	•	•	•
Swift	N95	•	•	•	≠	≠	•	•	≠	•	•	•	•	•	•	≠	•	•	≠	•	≠	≠	•	•	•	≠	•	≠	•	≠	•	•	•	•	•	•	•	•	•	•	•
Tag	N60	•	•	•	•	•	•	•	•	•	•	•	•	•	•	≠	•	•	•	•	•	•	•	•	•	•	•	•	•	•	•	•	•	•	•	•	•	•	•	•	•
Timberlane	39	•	•	•	•	•	•	•	•	•	•	•	•	•	•	≠	•	•	•	•	•	•	•	•	•	•	•	•	•	•	•	•	•	•	•	•	•	•	•	•	•
Triumph	88, 89	•	•	•	x	x	•	•	x	•	•	x	•	•	•	≠	•	•	x	•	x	x	•	•	•	x	•	x	•	•	•	•	•	•	•	•	•	•	•	•	•
Whimsy	66	•	•	•	≠	≠	•	•	≠	•	•	≠	•	•	•	≠	•	•	≠	•	≠	≠	•	•	•	≠	•	≠	•	≠	•	•	•	•	•	•	•	•	•	•	•

TB133

National Seating Fabric TB133 Fire Rated Pricing

Model Number	TB133 Fabric Grades							
	1	2/COM	3	4	6	7	L7	L8
N12AACF	\$ 928	\$ 956	\$ 969	\$ 988	\$ 1048	\$ 1097	\$ 1334	\$ 1409
N12AACSF	1023	1051	1064	1083	1143	1192	1429	1504
N12AAYF	1049	1077	1090	1109	1169	1218	1455	1530
N12ARF	845	873	886	905	965	1014	1251	1326
N12ARSF	940	968	981	1000	1060	1109	1346	1421
N12ARYF	966	994	1007	1026	1086	1135	1372	1447
N12BBCF	991	1026	1042	1066	1141	1203	1498	1593
N12BBCSF	1087	1122	1138	1162	1237	1299	1594	1689
N12BBYF	1112	1147	1163	1187	1262	1324	1619	1714
N12BRF	908	943	959	983	1058	1120	1415	1510
N12BRSF	1004	1039	1055	1079	1154	1216	1511	1606
N12BRYF	1030	1065	1081	1105	1180	1242	1537	1632
N12CCCF	1083	1111	1124	1143	1203	1252	1489	1564
N12CCCSF	1178	1206	1219	1238	1298	1347	1584	1659
N12CCYF	1206	1234	1247	1266	1326	1375	1612	1687
N12CRF	1000	1028	1041	1060	1120	1169	1406	1481
N12CRSF	1095	1123	1136	1155	1215	1264	1501	1576
N12CRYF	1122	1150	1163	1182	1242	1291	1528	1603
N12DDCF	1150	1185	1201	1225	1300	1362	1657	1752
N12DDCSF	1246	1281	1297	1321	1396	1458	1753	1848
N12DDYF	1273	1308	1324	1348	1423	1485	1780	1875
N12DRF	1068	1103	1119	1143	1218	1280	1575	1670
N12DRSF	1163	1198	1214	1238	1313	1375	1670	1765
N12DRYF	1188	1223	1239	1263	1338	1400	1695	1790
N12EECF	1124	1154	1168	1189	1254	1307	1563	1645
N12EECSF	1220	1250	1264	1285	1350	1403	1659	1741
N12ERF	1042	1072	1086	1107	1172	1225	1481	1563
N12ERSF	1136	1166	1180	1201	1266	1319	1575	1657
N12HHCF	1191	1228	1245	1271	1351	1417	1732	1833
N12HHCSF	1287	1324	1341	1367	1447	1513	1828	1929
N12HRF	1108	1145	1162	1188	1268	1334	1649	1750
N12HRSF	1202	1239	1256	1282	1362	1428	1743	1844
N12JJCEF	1214	1242	1255	1274	1334	1383	1620	1695
N12JJCESF	1310	1338	1351	1370	1430	1479	1716	1791
N12JJCF	1104	1132	1145	1164	1224	1273	1510	1585
N12JJCSF	1198	1226	1239	1258	1318	1367	1604	1679
N12JJYEF	1334	1362	1375	1394	1454	1503	1740	1815
N12JJYF	1224	1252	1265	1284	1344	1393	1630	1705
N12JREF	1131	1159	1172	1191	1251	1300	1537	1612
N12JRESF	1225	1253	1266	1285	1345	1394	1631	1706
N12JRF	1021	1049	1062	1081	1141	1190	1427	1502
N12JRSF	1115	1143	1156	1175	1235	1284	1521	1596
N12JRYEF	1252	1280	1293	1312	1372	1421	1658	1733
N12JRYF	1142	1170	1183	1202	1262	1311	1548	1623
N12KKCEF	1279	1314	1330	1354	1429	1491	1786	1881
N12KKCESF	1378	1413	1429	1453	1528	1590	1885	1980
N12KKCF	1169	1204	1220	1244	1319	1381	1676	1771
N12KKCSF	1266	1301	1317	1341	1416	1478	1773	1868
N12KKYEF	1399	1434	1450	1474	1549	1611	1906	2001
N12KKYF	1289	1324	1340	1364	1439	1501	1796	1891
N12KREF	1195	1230	1246	1270	1345	1407	1702	1797
N12KRESF	1293	1328	1344	1368	1443	1505	1800	1895
N12KRF	1085	1120	1136	1160	1235	1297	1592	1687
N12KRSF	1183	1218	1234	1258	1333	1395	1690	1785
N12KRYEF	1317	1352	1368	1392	1467	1529	1824	1919
N12KRYF	1207	1242	1258	1282	1357	1419	1714	1809
N12MMCEF	1253	1283	1297	1318	1383	1436	1692	1774

National Seating Fabric TB133 Fire Rated Pricing

Model Number	TB133 Fabric Grades							
	1	2/COM	3	4	6	7	L7	L8
N12MMCESF	\$ 1348	\$ 1378	\$ 1392	\$ 1413	\$ 1478	\$ 1531	\$ 1787	\$ 1869
N12MMCF	1142	1172	1186	1207	1272	1325	1581	1663
N12MMCSF	1238	1268	1282	1303	1368	1421	1677	1759
N12MREF	1169	1199	1213	1234	1299	1352	1608	1690
N12MRESF	1266	1296	1310	1331	1396	1449	1705	1787
N12MRF	1059	1089	1103	1124	1189	1242	1498	1580
N12MRSF	1156	1186	1200	1221	1286	1339	1595	1677
N12PPCEF	1320	1357	1374	1400	1480	1546	1861	1962
N12PPCESF	1414	1451	1468	1494	1574	1640	1955	2056
N12PPCF	1208	1245	1262	1288	1368	1434	1749	1850
N12PPCSF	1304	1341	1358	1384	1464	1530	1845	1946
N12PREF	1235	1272	1289	1315	1395	1461	1776	1877
N12PRESF	1332	1369	1386	1412	1492	1558	1873	1974
N12PRF	1125	1162	1179	1205	1285	1351	1666	1767
N12PRSF	1222	1259	1276	1302	1382	1448	1763	1864
N12QQF	796	828	844	866	936	993	1269	1357
N12RRF	730	755	767	785	840	885	1102	1171
N13CCCF	1177	1205	1218	1237	1297	1346	1583	1658
N13CCCSF	1273	1301	1314	1333	1393	1442	1679	1754
N13CCYF	1297	1325	1338	1357	1417	1466	1703	1778
N13CRF	1094	1122	1135	1154	1214	1263	1500	1575
N13CRSF	1188	1216	1229	1248	1308	1357	1594	1669
N13CRYF	1216	1244	1257	1276	1336	1385	1622	1697
N13DDCF	1245	1280	1296	1320	1395	1457	1752	1847
N13DDCSF	1338	1373	1389	1413	1488	1550	1845	1940
N13DDYF	1365	1400	1416	1440	1515	1577	1872	1967
N13DRF	1161	1196	1212	1236	1311	1373	1668	1763
N13DRSF	1256	1291	1307	1331	1406	1468	1763	1858
N13DRYF	1283	1318	1334	1358	1433	1495	1790	1885
N13EECF	1219	1249	1263	1284	1349	1402	1658	1740
N13EECSF	1311	1341	1355	1376	1441	1494	1750	1832
N13ERF	1135	1165	1179	1200	1265	1318	1574	1656
N13ERSF	1230	1260	1274	1295	1360	1413	1669	1751
N13HHCF	1286	1323	1340	1366	1446	1512	1827	1928
N13HHCSF	1379	1416	1433	1459	1539	1605	1920	2021
N13HRF	1201	1238	1255	1281	1361	1427	1742	1843
N13HRSF	1297	1334	1351	1377	1457	1523	1838	1939
N13JJCF	1199	1227	1240	1259	1319	1368	1605	1680
N13JJCSF	1293	1321	1334	1353	1413	1462	1699	1774
N13JJYF	1321	1349	1362	1381	1441	1490	1727	1802
N13JRF	1116	1144	1157	1176	1236	1285	1522	1597
N13JRSF	1212	1240	1253	1272	1332	1381	1618	1693
N13JRYF	1239	1267	1280	1299	1359	1408	1645	1720
N13KKCF	1266	1301	1317	1341	1416	1478	1773	1868
N13KKCSF	1362	1397	1413	1437	1512	1574	1869	1964
N13KKYF	1388	1423	1439	1463	1538	1600	1895	1990
N13KRF	1183	1218	1234	1258	1333	1395	1690	1785
N13KRSF	1280	1315	1331	1355	1430	1492	1787	1882
N13KRYF	1305	1340	1356	1380	1455	1517	1812	1907
N13MMCF	1238	1268	1282	1303	1368	1421	1677	1759
N13MMCSF	1332	1362	1376	1397	1462	1515	1771	1853
N13MRF	1156	1186	1200	1221	1286	1339	1595	1677
N13MRSF	1250	1280	1294	1315	1380	1433	1689	1771
N13PPCF	1305	1342	1359	1385	1465	1531	1846	1947
N13PPCSF	1403	1440	1457	1483	1563	1629	1944	2045
N13PRF	1223	1260	1277	1303	1383	1449	1764	1865
N13PRSF	1321	1358	1375	1401	1481	1547	1862	1963

TB133

National Seating Fabric TB133 Fire Rated Pricing

Model Number	TB133 Fabric Grades							
	1	2/COM	3	4	6	7	L7	L8
N14AACF	\$ 1007	\$ 1035	\$ 1048	\$ 1067	\$ 1127	\$ 1176	\$ 1413	\$ 1488
N14AACSF	1105	1133	1146	1165	1225	1274	1511	1586
N14AAYF	1129	1157	1170	1189	1249	1298	1535	1610
N14ARF	925	953	966	985	1045	1094	1331	1406
N14ARSF	1022	1050	1063	1082	1142	1191	1428	1503
N14ARYF	1046	1074	1087	1106	1166	1215	1452	1527
N14BBCF	1076	1111	1127	1151	1226	1288	1583	1678
N14BBCSF	1169	1204	1220	1244	1319	1381	1676	1771
N14BBYF	1198	1233	1249	1273	1348	1410	1705	1800
N14BRF	993	1028	1044	1068	1143	1205	1500	1595
N14BRSF	1085	1120	1136	1160	1235	1297	1592	1687
N14BRYF	1114	1149	1165	1189	1264	1326	1621	1716
N14CCCF	1257	1285	1298	1317	1377	1426	1663	1738
N14CCCSF	1355	1383	1396	1415	1475	1524	1761	1836
N14CCYF	1380	1408	1421	1440	1500	1549	1786	1861
N14CRF	1175	1203	1216	1235	1295	1344	1581	1656
N14CRSF	1273	1301	1314	1333	1393	1442	1679	1754
N14CRYF	1295	1323	1336	1355	1415	1464	1701	1776
N14DDCF	1325	1360	1376	1400	1475	1537	1832	1927
N14DDCSF	1421	1456	1472	1496	1571	1633	1928	2023
N14DDYF	1447	1482	1498	1522	1597	1659	1954	2049
N14DRF	1244	1279	1295	1319	1394	1456	1751	1846
N14DRSF	1336	1371	1387	1411	1486	1548	1843	1938
N14DRYF	1364	1399	1415	1439	1514	1576	1871	1966
N14EECF	1299	1329	1343	1364	1429	1482	1738	1820
N14EECSF	1394	1424	1438	1459	1524	1577	1833	1915
N14ERF	1218	1248	1262	1283	1348	1401	1657	1739
N14ERSF	1309	1339	1353	1374	1439	1492	1748	1830
N14HHCF	1365	1402	1419	1445	1525	1591	1906	2007
N14HHCSF	1463	1500	1517	1543	1623	1689	2004	2105
N14HRF	1282	1319	1336	1362	1442	1508	1823	1924
N14HRSF	1378	1415	1432	1458	1538	1604	1919	2020
N14JJCF	1282	1310	1323	1342	1402	1451	1688	1763
N14JJCSF	1378	1406	1419	1438	1498	1547	1784	1859
N14JJYF	1402	1430	1443	1462	1522	1571	1808	1883
N14JRF	1199	1227	1240	1259	1319	1368	1605	1680
N14JRSF	1293	1321	1334	1353	1413	1462	1699	1774
N14JRYF	1321	1349	1362	1381	1441	1490	1727	1802
N14KKCF	1349	1384	1400	1424	1499	1561	1856	1951
N14KKCSF	1441	1476	1492	1516	1591	1653	1948	2043
N14KKYF	1469	1504	1520	1544	1619	1681	1976	2071
N14KRF	1264	1299	1315	1339	1414	1476	1771	1866
N14KRSF	1360	1395	1411	1435	1510	1572	1867	1962
N14KRYF	1387	1422	1438	1462	1537	1599	1894	1989
N14MMCF	1323	1353	1367	1388	1453	1506	1762	1844
N14MMCSF	1415	1445	1459	1480	1545	1598	1854	1936
N14MRF	1238	1268	1282	1303	1368	1421	1677	1759
N14MRSF	1334	1364	1378	1399	1464	1517	1773	1855
N14PPCF	1391	1428	1445	1471	1551	1617	1932	2033
N14PPCSF	1484	1521	1538	1564	1644	1710	2025	2126
N14PRF	1306	1343	1360	1386	1466	1532	1847	1948
N14PRSF	1402	1439	1456	1482	1562	1628	1943	2044
N14QQF	867	899	915	937	1007	1064	1340	1428
N14RRF	800	825	837	855	910	955	1172	1241
N15AAYF	903	924	934	948	993	1030	1207	1264
N15ARYF	820	841	851	865	910	947	1124	1181
N15CCYF	1058	1079	1089	1103	1148	1185	1362	1419

National Seating Fabric TB133 Fire Rated Pricing

Model Number	TB133 Fabric Grades							
	1	2/COM	3	4	6	7	L7	L8
N15CRYF	\$ 976	\$ 997	\$ 1007	\$ 1021	\$ 1066	\$ 1103	\$ 1280	\$ 1337
N15EEF	965	986	996	1010	1055	1092	1269	1326
N15EESF	1060	1081	1091	1105	1150	1187	1364	1421
N15ERF	883	904	914	928	973	1010	1187	1244
N15ERSF	978	999	1009	1023	1068	1105	1282	1339
N15GGF	810	831	841	855	900	937	1114	1171
N15GGSF	905	926	936	950	995	1032	1209	1266
N15GRF	727	748	758	772	817	854	1031	1088
N15GRSF	822	843	853	867	912	949	1126	1183
N15HHF	1076	1097	1107	1121	1166	1203	1380	1437
N15HHSF	1172	1193	1203	1217	1262	1299	1476	1533
N15HRF	994	1015	1025	1039	1084	1121	1298	1355
N15HRSF	1088	1109	1119	1133	1178	1215	1392	1449
N15JJYEF	1188	1209	1219	1233	1278	1315	1492	1549
N15JJYF	1078	1099	1109	1123	1168	1205	1382	1439
N15JRYEF	1106	1127	1137	1151	1196	1233	1410	1467
N15JRYF	996	1017	1027	1041	1086	1123	1300	1357
N15LLF	920	941	951	965	1010	1047	1224	1281
N15LLSF	1015	1036	1046	1060	1105	1142	1319	1376
N15LRF	837	858	868	882	927	964	1141	1198
N15LRSF	932	953	963	977	1022	1059	1236	1293
N15MMEF	1094	1115	1125	1139	1184	1221	1398	1455
N15MMESF	1190	1211	1221	1235	1280	1317	1494	1551
N15MMF	984	1005	1015	1029	1074	1111	1288	1345
N15MMSF	1080	1101	1111	1125	1170	1207	1384	1441
N15MREF	1011	1032	1042	1056	1101	1138	1315	1372
N15MRESF	1108	1129	1139	1153	1198	1235	1412	1469
N15MRF	901	922	932	946	991	1028	1205	1262
N15MRSF	998	1019	1029	1043	1088	1125	1302	1359
N15PPEF	1205	1226	1236	1250	1295	1332	1509	1566
N15PPESF	1300	1321	1331	1345	1390	1427	1604	1661
N15PPF	1094	1115	1125	1139	1184	1221	1398	1455
N15PPSF	1190	1211	1221	1235	1280	1317	1494	1551
N15PREF	1121	1142	1152	1166	1211	1248	1425	1482
N15PRESF	1218	1239	1249	1263	1308	1345	1522	1579
N15PRF	1011	1032	1042	1056	1101	1138	1315	1372
N15PRSF	1108	1129	1139	1153	1198	1235	1412	1469
N15RRF	736	757	767	781	826	863	1040	1097
N16CCYF	1151	1172	1182	1196	1241	1278	1455	1512
N16CRYF	1070	1091	1101	1115	1160	1197	1374	1431
N16EEF	1059	1080	1090	1104	1149	1186	1363	1420
N16EESF	1153	1174	1184	1198	1243	1280	1457	1514
N16ERF	977	998	1008	1022	1067	1104	1281	1338
N16ERSF	1072	1093	1103	1117	1162	1199	1376	1433
N16HHF	1171	1192	1202	1216	1261	1298	1475	1532
N16HHSF	1263	1284	1294	1308	1353	1390	1567	1624
N16HRF	1087	1108	1118	1132	1177	1214	1391	1448
N16HRSF	1182	1203	1213	1227	1272	1309	1486	1543
N16JJYF	1175	1196	1206	1220	1265	1302	1479	1536
N16JRYF	1092	1113	1123	1137	1182	1219	1396	1453
N16MMF	1080	1101	1111	1125	1170	1207	1384	1441
N16MMSF	1174	1195	1205	1219	1264	1301	1478	1535
N16MRF	998	1019	1029	1043	1088	1125	1302	1359
N16MRSF	1091	1112	1122	1136	1181	1218	1395	1452
N16PPF	1190	1211	1221	1235	1280	1317	1494	1551
N16PPSF	1284	1305	1315	1329	1374	1411	1588	1645
N16PRF	1108	1129	1139	1153	1198	1235	1412	1469

TB133

National Seating Fabric TB133 Fire Rated Pricing

Model Number	TB133 Fabric Grades							
	1	2/COM	3	4	6	7	L7	L8
N16PRSF	\$ 1202	\$ 1223	\$ 1233	\$ 1247	\$ 1292	\$ 1329	\$ 1506	\$ 1563
N17AAYF	982	1003	1013	1027	1072	1109	1286	1343
N17ARYF	900	921	931	945	990	1027	1204	1261
N17CCYF	1233	1254	1264	1278	1323	1360	1537	1594
N17CRYF	1149	1170	1180	1194	1239	1276	1453	1510
N17EEF	1141	1162	1172	1186	1231	1268	1445	1502
N17EESF	1346	1367	1377	1391	1436	1473	1650	1707
N17ERF	1058	1079	1089	1103	1148	1185	1362	1419
N17ERSF	1261	1282	1292	1306	1351	1388	1565	1622
N17GGF	891	912	922	936	981	1018	1195	1252
N17GGSF	985	1006	1016	1030	1075	1112	1289	1346
N17GRF	808	829	839	853	898	935	1112	1169
N17GRSF	902	923	933	947	992	1029	1206	1263
N17HHF	1251	1272	1282	1296	1341	1378	1555	1612
N17HHSF	1456	1477	1487	1501	1546	1583	1760	1817
N17HRF	1170	1191	1201	1215	1260	1297	1474	1531
N17HRSF	1372	1393	1403	1417	1462	1499	1676	1733
N17JJYF	1256	1277	1287	1301	1346	1383	1560	1617
N17JRYF	1175	1196	1206	1220	1265	1302	1479	1536
N17LLF	1001	1022	1032	1046	1091	1128	1305	1362
N17LLSF	1095	1116	1126	1140	1185	1222	1399	1456
N17LRF	918	939	949	963	1008	1045	1222	1279
N17LRSF	1012	1033	1043	1057	1102	1139	1316	1373
N17MMF	1163	1184	1194	1208	1253	1290	1467	1524
N17MMSF	1257	1278	1288	1302	1347	1384	1561	1618
N17MRF	1080	1101	1111	1125	1170	1207	1384	1441
N17MRSF	1176	1197	1207	1221	1266	1303	1480	1537
N17PPF	1275	1296	1306	1320	1365	1402	1579	1636
N17PPSF	1367	1388	1398	1412	1457	1494	1671	1728
N17PRF	1190	1211	1221	1235	1280	1317	1494	1551
N17PRSF	1286	1307	1317	1331	1376	1413	1590	1647
N17RRF	807	828	838	852	897	934	1111	1168
N23AACF								
N23AACYF								
N23BBCF								
N23BBCYF								
N23CCCDF								
N23CCCF								
N23CCCYDF								
N23CCCYF								
N23DDCDF								
N23DDCF								
N23EECDF								
N23EECF								
N23EECYDF								
N23EECYF								
N23HHCDF								
N23HHCF								
N23JJCF								
N23KKCF								
N23MMCF								
N23PPCF								
N23RRCF								
N23SSCF								
N24AACF								
N24BBCF								
N24CCCDF								
N24CCCF								

National Seating Fabric TB133 Fire Rated Pricing

Model Number	TB133 Fabric Grades							
	1	2/COM	3	4	6	7	L7	L8
N24DDCDF	\$ 1074	\$ 1096	\$ 1107	\$ 1123	\$ 1171	\$ 1211	\$ 1402	\$ 1463
N24DDCF								
N24EECDF								
N24EECF								
N24HHCDF								
N24HHCF								
N24JJCF								
N24KKCF								
N24MMCF								
N24PPCF								
N24RRCF								
N24SSCF								
N25AACF								
N25AACYF								
N25BBCF								
N25BBCYF								
N25CCCDF								
N25CCCF								
N25CCXDF								
N25CCXF								
N25CCYDF								
N25CCYF								
N25DDCDF								
N25DDCF								
N25DDXDF								
N25DDXF								
N25EECDF								
N25EECF								
N25EECYDF								
N25EECYF								
N25HHCDF								
N25HHCF								
N25JJCF								
N25KKCF								
N25MMCF								
N25PPCF								
N25RRCF								
N25SSCF								
N26AACF								
N26BBCF								
N26CCCDF								
N26CCCF								
N26DDCDF								
N26DDCF								
N26DDXDF								
N26DDXF								
N26EECDF								
N26EECF								
N26HHCDF								
N26HHCF								
N26JJCF								
N26KKCF								
N26KKXF								
N26MMCF								
N26PPCF								
N26RRCF								
N26SSCF								

TB133

National Seating Fabric TB133 Fire Rated Pricing

Model Number	TB133 Fabric Grades							
	1	2/COM	3	4	6	7	L7	L8
N30GM1UNCF	\$	\$	\$	\$	\$	\$	\$	\$
N30GM1UNF								
N30GM1UPCF								
N30GM1UPF								
N30GM9UNCF								
N30GM9UNF								
N30GM9UPCF								
N30GM9UPF								
N30GP1UNCF	657	678	688	702	747	784	961	1018
N30GP1UNCXF								
N30GP1UNF	657	678	688	702	747	784	961	1018
N30GP1UNXF								
N30GP1UPCF	632	653	663	677	722	759	936	993
N30GP1UPCXF								
N30GP1UPF	632	653	663	677	722	759	936	993
N30GP1UPXF								
N30GP9UNCF	707	728	738	752	797	834	1011	1068
N30GP9UNCXF								
N30GP9UNF	707	728	738	752	797	834	1011	1068
N30GP9UNXF								
N30GP9UPCF	682	703	713	727	772	809	986	1043
N30GP9UPCXF								
N30GP9UPF	682	703	713	727	772	809	986	1043
N30GP9UPXF								
N30GU1UNCF	707	728	738	752	797	834	1011	1068
N30GU1UNCXF								
N30GU1UNF	707	728	738	752	797	834	1011	1068
N30GU1UNXF								
N30GU1UPCF	682	703	713	727	772	809	986	1043
N30GU1UPCXF								
N30GU1UPF	682	703	713	727	772	809	986	1043
N30GU1UPXF								
N30GU9UNCF	758	779	789	803	848	885	1062	1119
N30GU9UNCXF								
N30GU9UNF	758	779	789	803	848	885	1062	1119
N30GU9UNXF								
N30GU9UPCF	733	754	764	778	823	860	1037	1094
N30GU9UPCXF								
N30GU9UPF	733	754	764	778	823	860	1037	1094
N30GU9UPXF								
N30HM1SNF								
N30HM1SPF								
N30HM1SSNF								
N30HM1SSPF								
N30HM2SNF								
N30HM2SPF								
N30HM2SSNF								
N30HM2SSPF								
N30HM3SNF								
N30HM3SPF								
N30HM3SSNF								
N30HM3SSPF								
N30HM8SNF								
N30HM8SSNF								
N30HM9SNF								
N30HM9SPF								
N30HM9SSNF								

National Seating Fabric TB133 Fire Rated Pricing

Model Number	TB133 Fabric Grades							
	1	2/COM	3	4	6	7	L7	L8
N30HM9SSPF	\$	\$	\$	\$	\$	\$	\$	\$
N30HML1SNF								
N30HML1SPF								
N30HML1SSNF								
N30HML1SSPF								
N30HML2SNF								
N30HML2SPF								
N30HML2SSNF								
N30HML2SSPF								
N30HML3SNF								
N30HML3SPF								
N30HML3SSNF								
N30HML3SSPF								
N30HML8SNF								
N30HML8SSNF								
N30HML9SNF								
N30HML9SPF								
N30HML9SSNF								
N30HML9SSPF								
N30HP1SNF	998	1028	1042	1063	1128	1181	1437	1519
N30HP1SNXF								
N30HP1SPF	897	927	941	962	1027	1080	1336	1418
N30HP1SPXF								
N30HP1SSNF	1089	1119	1133	1154	1219	1272	1528	1610
N30HP1SSNXF								
N30HP1SSPF	988	1018	1032	1053	1118	1171	1427	1509
N30HP1SSPXF								
N30HP2SNF	1099	1129	1143	1164	1229	1282	1538	1620
N30HP2SNXF								
N30HP2SPF	998	1028	1042	1063	1128	1181	1437	1519
N30HP2SPXF								
N30HP2SSNF	1190	1220	1234	1255	1320	1373	1629	1711
N30HP2SSNXF								
N30HP2SSPF	1089	1119	1133	1154	1219	1272	1528	1610
N30HP2SSPXF								
N30HP3SNF	1149	1179	1193	1214	1279	1332	1588	1670
N30HP3SNXF								
N30HP3SPF	1048	1078	1092	1113	1178	1231	1487	1569
N30HP3SPXF								
N30HP3SSNF	1240	1270	1284	1305	1370	1423	1679	1761
N30HP3SSNXF								
N30HP3SSPF	1139	1169	1183	1204	1269	1322	1578	1660
N30HP3SSPXF								
N30HP8SNF	1250	1280	1294	1315	1380	1433	1689	1771
N30HP8SNXF								
N30HP8SSNF	1341	1371	1385	1406	1471	1524	1780	1862
N30HP8SSNXF								
N30HP9SNF	1048	1078	1092	1113	1178	1231	1487	1569
N30HP9SNXF								
N30HP9SPF	947	977	991	1012	1077	1130	1386	1468
N30HP9SPXF								
N30HP9SSNF	1139	1169	1183	1204	1269	1322	1578	1660
N30HP9SSNXF								
N30HP9SSPF	1038	1068	1082	1103	1168	1221	1477	1559
N30HP9SSPXF								
N30HU1SNF	1065	1100	1116	1140	1215	1277	1572	1667
N30HU1SNXF								

TB133

National Seating Fabric TB133 Fire Rated Pricing

Model Number	TB133 Fabric Grades							
	1	2/COM	3	4	6	7	L7	L8
N30HU1SPF	\$ 964	\$ 999	\$ 1015	\$ 1039	\$ 1114	\$ 1176	\$ 1471	\$ 1566
N30HU1SPXF								
N30HU1SSNF	1156	1191	1207	1231	1306	1368	1663	1758
N30HU1SSNXF								
N30HU1SSPF	1055	1090	1106	1130	1205	1267	1562	1657
N30HU1SSPXF								
N30HU2SNF	1166	1201	1217	1241	1316	1378	1673	1768
N30HU2SNXF								
N30HU2SPF	1065	1100	1116	1140	1215	1277	1572	1667
N30HU2SPXF								
N30HU2SSNF	1257	1292	1308	1332	1407	1469	1764	1859
N30HU2SSNXF								
N30HU2SSPF	1156	1191	1207	1231	1306	1368	1663	1758
N30HU2SSPXF								
N30HU3SNF	1217	1252	1268	1292	1367	1429	1724	1819
N30HU3SNXF								
N30HU3SPF	1116	1151	1167	1191	1266	1328	1623	1718
N30HU3SPXF								
N30HU3SSNF	1308	1343	1359	1383	1458	1520	1815	1910
N30HU3SSNXF								
N30HU3SSPF	1207	1242	1258	1282	1357	1419	1714	1809
N30HU3SSPXF								
N30HU8SNF	1318	1353	1369	1393	1468	1530	1825	1920
N30HU8SNXF								
N30HU8SSNF	1409	1444	1460	1484	1559	1621	1916	2011
N30HU8SSNXF								
N30HU9SNF	1116	1151	1167	1191	1266	1328	1623	1718
N30HU9SNXF								
N30HU9SPF	1015	1050	1066	1090	1165	1227	1522	1617
N30HU9SPXF								
N30HU9SSNF	1207	1242	1258	1282	1357	1419	1714	1809
N30HU9SSNXF								
N30HU9SSPF	1106	1141	1157	1181	1256	1318	1613	1708
N30HU9SSPXF								
N30MP1SNF	944	972	985	1004	1064	1113	1350	1425
N30MP1SNXF								
N30MP1SPF	843	871	884	903	963	1012	1249	1324
N30MP1SPXF								
N30MP1SSNF	1035	1063	1076	1095	1155	1204	1441	1516
N30MP1SSNXF								
N30MP1SSPF	934	962	975	994	1054	1103	1340	1415
N30MP1SSPXF								
N30MP2SNF	1045	1073	1086	1105	1165	1214	1451	1526
N30MP2SNXF								
N30MP2SPF	944	972	985	1004	1064	1113	1350	1425
N30MP2SPXF								
N30MP2SSNF	1136	1164	1177	1196	1256	1305	1542	1617
N30MP2SSNXF								
N30MP2SSPF	1035	1063	1076	1095	1155	1204	1441	1516
N30MP2SSPXF								
N30MP3SNF	1096	1124	1137	1156	1216	1265	1502	1577
N30MP3SNXF								
N30MP3SPF	995	1023	1036	1055	1115	1164	1401	1476
N30MP3SPXF								
N30MP3SSNF	1187	1215	1228	1247	1307	1356	1593	1668
N30MP3SSNXF								
N30MP3SSPF	1086	1114	1127	1146	1206	1255	1492	1567

National Seating Fabric TB133 Fire Rated Pricing

Model Number	TB133 Fabric Grades							
	1	2/COM	3	4	6	7	L7	L8
N30MP3SSPXF	\$	\$	\$	\$	\$	\$	\$	\$
N30MP8SNF	1197	1225	1238	1257	1317	1366	1603	1678
N30MP8SNXF								
N30MP8SSNF	1288	1316	1329	1348	1408	1457	1694	1769
N30MP8SSNXF								
N30MP9SNF	995	1023	1036	1055	1115	1164	1401	1476
N30MP9SNXF								
N30MP9SPF	894	922	935	954	1014	1063	1300	1375
N30MP9SPXF								
N30MP9SSNF	1086	1114	1127	1146	1206	1255	1492	1567
N30MP9SSNXF								
N30MP9SSPF	985	1013	1026	1045	1105	1154	1391	1466
N30MP9SSPXF								
N30MU1SNF	1012	1044	1060	1082	1152	1209	1485	1573
N30MU1SNXF								
N30MU1SPF	911	943	959	981	1051	1108	1384	1472
N30MU1SPXF								
N30MU1SSNF	1103	1135	1151	1173	1243	1300	1576	1664
N30MU1SSNXF								
N30MU1SSPF	1002	1034	1050	1072	1142	1199	1475	1563
N30MU1SSPXF								
N30MU2SNF	1113	1145	1161	1183	1253	1310	1586	1674
N30MU2SNXF								
N30MU2SPF	1012	1044	1060	1082	1152	1209	1485	1573
N30MU2SPXF								
N30MU2SSNF	1204	1236	1252	1274	1344	1401	1677	1765
N30MU2SSNXF								
N30MU2SSPF	1103	1135	1151	1173	1243	1300	1576	1664
N30MU2SSPXF								
N30MU3SNF	1163	1195	1211	1233	1303	1360	1636	1724
N30MU3SNXF								
N30MU3SPF	1062	1094	1110	1132	1202	1259	1535	1623
N30MU3SPXF								
N30MU3SSNF	1254	1286	1302	1324	1394	1451	1727	1815
N30MU3SSNXF								
N30MU3SSPF	1153	1185	1201	1223	1293	1350	1626	1714
N30MU3SSPXF								
N30MU8SNF	1264	1296	1312	1334	1404	1461	1737	1825
N30MU8SNXF								
N30MU8SSNF	1355	1387	1403	1425	1495	1552	1828	1916
N30MU8SSNXF								
N30MU9SNF	1062	1094	1110	1132	1202	1259	1535	1623
N30MU9SNXF								
N30MU9SPF	961	993	1009	1031	1101	1158	1434	1522
N30MU9SPXF								
N30MU9SSNF	1153	1185	1201	1223	1293	1350	1626	1714
N30MU9SSNXF								
N30MU9SSPF	1052	1084	1100	1122	1192	1249	1525	1613
N30MU9SSPXF								
N30SP1SNF	970	998	1011	1030	1090	1139	1376	1451
N30SP1SNGF	970	998	1011	1030	1090	1139	1376	1451
N30SP1SNGXF								
N30SP1SNXF								
N30SP1SPF	869	897	910	929	989	1038	1275	1350
N30SP1SPGF	869	897	910	929	989	1038	1275	1350
N30SP1SPGXF								
N30SP1SPXF								

TB133

National Seating Fabric TB133 Fire Rated Pricing

Model Number	TB133 Fabric Grades							
	1	2/COM	3	4	6	7	L7	L8
N30SP2SNF	\$ 1071	\$ 1099	\$ 1112	\$ 1131	\$ 1191	\$ 1240	\$ 1477	\$ 1552
N30SP2SNGF	1071	1099	1112	1131	1191	1240	1477	1552
N30SP2SNGXF								
N30SP2SNXF								
N30SP2SPF	970	998	1011	1030	1090	1139	1376	1451
N30SP2SPGF	970	998	1011	1030	1090	1139	1376	1451
N30SP2SPGXF								
N30SP2SPXF								
N30SP3SNF	1121	1149	1162	1181	1241	1290	1527	1602
N30SP3SNGF	1121	1149	1162	1181	1241	1290	1527	1602
N30SP3SNGXF								
N30SP3SNXF								
N30SP3SPF	1020	1048	1061	1080	1140	1189	1426	1501
N30SP3SPGF	1020	1048	1061	1080	1140	1189	1426	1501
N30SP3SPGXF								
N30SP3SPXF								
N30SP8SNF	1222	1250	1263	1282	1342	1391	1628	1703
N30SP8SNGF	1222	1250	1263	1282	1342	1391	1628	1703
N30SP8SNGXF								
N30SP8SNXF								
N30SP9SNF	1020	1048	1061	1080	1140	1189	1426	1501
N30SP9SNGF	1020	1048	1061	1080	1140	1189	1426	1501
N30SP9SNGXF								
N30SP9SNXF								
N30SP9SPF	919	947	960	979	1039	1088	1325	1400
N30SP9SPGF	919	947	960	979	1039	1088	1325	1400
N30SP9SPGXF								
N30SP9SPXF								
N30SU1SNF	1062	1094	1110	1132	1202	1259	1535	1623
N30SU1SNGF	1062	1094	1110	1132	1202	1259	1535	1623
N30SU1SNGXF								
N30SU1SNXF								
N30SU1SPF	961	993	1009	1031	1101	1158	1434	1522
N30SU1SPGF	961	993	1009	1031	1101	1158	1434	1522
N30SU1SPGXF								
N30SU1SPXF								
N30SU2SNF	1163	1195	1211	1233	1303	1360	1636	1724
N30SU2SNGF	1163	1195	1211	1233	1303	1360	1636	1724
N30SU2SNGXF								
N30SU2SNXF								
N30SU2SPF	1062	1094	1110	1132	1202	1259	1535	1623
N30SU2SPGF	1062	1094	1110	1132	1202	1259	1535	1623
N30SU2SPGXF								
N30SU2SPXF								
N30SU3SNF	1214	1246	1262	1284	1354	1411	1687	1775
N30SU3SNGF	1214	1246	1262	1284	1354	1411	1687	1775
N30SU3SNGXF								
N30SU3SNXF								
N30SU3SPF	1113	1145	1161	1183	1253	1310	1586	1674
N30SU3SPGF	1113	1145	1161	1183	1253	1310	1586	1674
N30SU3SPGXF								
N30SU3SPXF								
N30SU8SNF	1315	1347	1363	1385	1455	1512	1788	1876
N30SU8SNGF	1315	1347	1363	1385	1455	1512	1788	1876
N30SU8SNGXF								
N30SU8SNXF								
N30SU9SNF	1113	1145	1161	1183	1253	1310	1586	1674

National Seating Fabric TB133 Fire Rated Pricing

Model Number	TB133 Fabric Grades							
	1	2/COM	3	4	6	7	L7	L8
N30SU9SNGF	\$ 1113	\$ 1145	\$ 1161	\$ 1183	\$ 1253	\$ 1310	\$ 1586	\$ 1674
N30SU9SNGXF								
N30SU9SNXF								
N30SU9SPF	1012	1044	1060	1082	1152	1209	1485	1573
N30SU9SPGF	1012	1044	1060	1082	1152	1209	1485	1573
N30SU9SPGXF								
N30SU9SPXF								
N32AAMF	1988	2101	2155	2233	2478	2679	3644	3953
N32AAMSF	2083	2198	2253	2333	2583	2788	3773	4088
N32AAWF	2104	2217	2271	2349	2594	2795	3760	4069
N32AAWSF	2200	2315	2370	2450	2700	2905	3890	4205
N32BBMF	2135	2248	2302	2380	2625	2826	3791	4100
N32BBMSF	2200	2315	2370	2450	2700	2905	3890	4205
N32BBWF	2253	2366	2420	2498	2743	2944	3909	4218
N32BBWSF	2348	2463	2518	2598	2848	3053	4038	4353
N32CCMLF	2360	2473	2527	2605	2850	3051	4016	4325
N32CCMSF	2456	2571	2626	2706	2956	3161	4146	4461
N32CCMRF	2360	2473	2527	2605	2850	3051	4016	4325
N32CCMRSF	2456	2571	2626	2706	2956	3161	4146	4461
N32CCWLF	2477	2590	2644	2722	2967	3168	4133	4442
N32CCWLSF	2573	2688	2743	2823	3073	3278	4263	4578
N32CCWRF	2477	2590	2644	2722	2967	3168	4133	4442
N32CCWRSF	2573	2688	2743	2823	3073	3278	4263	4578
N32DDMLF	2495	2608	2662	2740	2985	3186	4151	4460
N32DDMSF	2590	2705	2760	2840	3090	3295	4280	4595
N32DDMRF	2495	2608	2662	2740	2985	3186	4151	4460
N32DDMRSF	2590	2705	2760	2840	3090	3295	4280	4595
N32DDWLF	2611	2724	2778	2856	3101	3302	4267	4576
N32DDWLSF	2708	2823	2878	2958	3208	3413	4398	4713
N32DDWRF	2611	2724	2778	2856	3101	3302	4267	4576
N32DDWRSF	2708	2823	2878	2958	3208	3413	4398	4713
N32HHMF	2855	3062	3161	3305	3755	4124	5897	6464
N32HHMSF	3035	3267	3378	3540	4045	4459	6449	7085
N32HHWF	2973	3180	3279	3423	3873	4242	6015	6582
N32HHWSF	3151	3383	3494	3656	4161	4575	6565	7201
N32HKMF	1639	1717	1755	1809	1979	2118	2788	3002
N32HKWF	1758	1836	1874	1928	2098	2237	2907	3121
N32JJMBF	3599	3806	3905	4049	4499	4868	6641	7208
N32JJMSF	3778	4010	4121	4283	4788	5202	7192	7828
N32JJMLF	3227	3434	3533	3677	4127	4496	6269	6836
N32JJMSF	3405	3637	3748	3910	4415	4829	6819	7455
N32JJMRF	3227	3434	3533	3677	4127	4496	6269	6836
N32JJMRSF	3405	3637	3748	3910	4415	4829	6819	7455
N32JJWBF	3716	3923	4022	4166	4616	4985	6758	7325
N32JJWBSF	3896	4128	4239	4401	4906	5320	7310	7946
N32JJWLF	3343	3550	3649	3793	4243	4612	6385	6952
N32JJWLSF	3523	3755	3866	4028	4533	4947	6937	7573
N32JJWRF	3343	3550	3649	3793	4243	4612	6385	6952
N32JJWRSF	3523	3755	3866	4028	4533	4947	6937	7573
N32KKCF	921	952	967	989	1056	1111	1377	1462
N32KKMF	729	760	775	797	864	919	1185	1270
N32KKWF	847	878	893	915	982	1037	1303	1388
N32LKMF	1869	1943	1978	2029	2189	2320	2951	3152
N32LKWF	1987	2061	2096	2147	2307	2438	3069	3270
N32LLMF	3370	3575	3673	3815	4260	4625	6378	6939
N32LLMSF	3525	3748	3855	4010	4495	4893	6804	7415
N32LLWF	3487	3692	3790	3932	4377	4742	6495	7056

TB133

National Seating Fabric TB133 Fire Rated Pricing

Model Number	TB133 Fabric Grades							
	1	2/COM	3	4	6	7	L7	L8
N32LLWSF	\$ 3642	\$ 3865	\$ 3972	\$ 4127	\$ 4612	\$ 5010	\$ 6921	\$ 7532
N32MAAMF	1701	1765	1796	1841	1981	2096	2647	2824
N32MAAWF	1818	1882	1913	1958	2098	2213	2764	2941
N32MBBMF	1849	1913	1944	1989	2129	2244	2795	2972
N32MBBWF	1966	2030	2061	2106	2246	2361	2912	3089
N32MHMF	2544	2696	2768	2874	3204	3475	4775	5191
N32MHHWF	2661	2813	2885	2991	3321	3592	4892	5308
N32MLLMF	2992	3123	3186	3277	3562	3796	4919	5278
N32MLLWF	3109	3240	3303	3394	3679	3913	5036	5395
N32MMMBF	4114	4319	4417	4559	5004	5369	7122	7683
N32MMBSF	4270	4493	4600	4755	5240	5638	7549	8160
N32MMMLF	3742	3947	4045	4187	4632	4997	6750	7311
N32MMLSF	3897	4120	4227	4382	4867	5265	7176	7787
N32MMRWF	3742	3947	4045	4187	4632	4997	6750	7311
N32MMRFSF	3897	4120	4227	4382	4867	5265	7176	7787
N32MMWBF	4232	4437	4535	4677	5122	5487	7240	7801
N32MMWBSF	4386	4609	4716	4871	5356	5754	7665	8276
N32MMWLF	3859	4064	4162	4304	4749	5114	6867	7428
N32MMWLSF	4013	4236	4343	4498	4983	5381	7292	7903
N32MMWRF	3859	4064	4162	4304	4749	5114	6867	7428
N32MMWRSF	4013	4236	4343	4498	4983	5381	7292	7903
N32SAAMF	1988	2101	2155	2233	2478	2679	3644	3953
N32SAAMSF	2083	2198	2253	2333	2583	2788	3773	4088
N32SAAWF	2104	2217	2271	2349	2594	2795	3760	4069
N32SAAWSF	2200	2315	2370	2450	2700	2905	3890	4205
N32SBBMF	2135	2248	2302	2380	2625	2826	3791	4100
N32SBBMSF	2200	2315	2370	2450	2700	2905	3890	4205
N32SBBWF	2253	2366	2420	2498	2743	2944	3909	4218
N32SBBWSF	2348	2463	2518	2598	2848	3053	4038	4353
N32SCCLF	2360	2473	2527	2605	2850	3051	4016	4325
N32SCCLSF	2456	2571	2626	2706	2956	3161	4146	4461
N32SCCMRF	2360	2473	2527	2605	2850	3051	4016	4325
N32SCCMRSF	2456	2571	2626	2706	2956	3161	4146	4461
N32SCCWLF	2477	2590	2644	2722	2967	3168	4133	4442
N32SCCWLSF	2573	2688	2743	2823	3073	3278	4263	4578
N32SCCWRF	2477	2590	2644	2722	2967	3168	4133	4442
N32SCCWRSF	2573	2688	2743	2823	3073	3278	4263	4578
N32SDDMLF	2495	2608	2662	2740	2985	3186	4151	4460
N32SDDMSF	2590	2705	2760	2840	3090	3295	4280	4595
N32SDDMRWF	2495	2608	2662	2740	2985	3186	4151	4460
N32SDDMRSF	2590	2705	2760	2840	3090	3295	4280	4595
N32SDDWLF	2611	2724	2778	2856	3101	3302	4267	4576
N32SDDWLSF	2708	2823	2878	2958	3208	3413	4398	4713
N32SDDWRF	2611	2724	2778	2856	3101	3302	4267	4576
N32SDDWRSF	2708	2823	2878	2958	3208	3413	4398	4713
N32SHMF	2855	3062	3161	3305	3755	4124	5897	6464
N32SHMSF	3035	3267	3378	3540	4045	4459	6449	7085
N32SHHWF	2973	3180	3279	3423	3873	4242	6015	6582
N32SHHWSF	3151	3383	3494	3656	4161	4575	6565	7201
N32SJJMBF	3599	3806	3905	4049	4499	4868	6641	7208
N32SJJMSF	3778	4010	4121	4283	4788	5202	7192	7828
N32SJJMLF	3227	3434	3533	3677	4127	4496	6269	6836
N32SJJMSF	3405	3637	3748	3910	4415	4829	6819	7455
N32SJJMRWF	3227	3434	3533	3677	4127	4496	6269	6836
N32SJJMRSF	3405	3637	3748	3910	4415	4829	6819	7455
N32SJJWBF	3716	3923	4022	4166	4616	4985	6758	7325
N32SJJWBSF	3896	4128	4239	4401	4906	5320	7310	7946

National Seating Fabric TB133 Fire Rated Pricing

Model Number	TB133 Fabric Grades							
	1	2/COM	3	4	6	7	L7	L8
N32SJJWLF	\$ 3343	\$ 3550	\$ 3649	\$ 3793	\$ 4243	\$ 4612	\$ 6385	\$ 6952
N32SJJWLSF	3523	3755	3866	4028	4533	4947	6937	7573
N32SJJWRF	3343	3550	3649	3793	4243	4612	6385	6952
N32SJJWRSF	3523	3755	3866	4028	4533	4947	6937	7573
N32SLLMF	3370	3575	3673	3815	4260	4625	6378	6939
N32SLLMSF	3525	3748	3855	4010	4495	4893	6804	7415
N32SLLWF	3487	3692	3790	3932	4377	4742	6495	7056
N32SLLWSF	3642	3865	3972	4127	4612	5010	6921	7532
N32SMAAMF	1701	1765	1796	1841	1981	2096	2647	2824
N32SMAAWF	1818	1882	1913	1958	2098	2213	2764	2941
N32SMBBMF	1849	1913	1944	1989	2129	2244	2795	2972
N32SMBBWF	1966	2030	2061	2106	2246	2361	2912	3089
N32SMHHMF	2544	2696	2768	2874	3204	3475	4775	5191
N32SMHHWF	2661	2813	2885	2991	3321	3592	4892	5308
N32SMLLMF	2992	3123	3186	3277	3562	3796	4919	5278
N32SMLLWF	3109	3240	3303	3394	3679	3913	5036	5395
N32SMMMBSF	4114	4319	4417	4559	5004	5369	7122	7683
N32SMMMBSF	4270	4493	4600	4755	5240	5638	7549	8160
N32SMMMBSF	3742	3947	4045	4187	4632	4997	6750	7311
N32SMMMBSF	3897	4120	4227	4382	4867	5265	7176	7787
N32SMMMBSF	3742	3947	4045	4187	4632	4997	6750	7311
N32SMMMBSF	3897	4120	4227	4382	4867	5265	7176	7787
N32SMMWBF	4232	4437	4535	4677	5122	5487	7240	7801
N32SMMWBSF	4386	4609	4716	4871	5356	5754	7665	8276
N32SMMWLF	3859	4064	4162	4304	4749	5114	6867	7428
N32SMMWLSF	4013	4236	4343	4498	4983	5381	7292	7903
N32SMMWRF	3859	4064	4162	4304	4749	5114	6867	7428
N32SMMWRSF	4013	4236	4343	4498	4983	5381	7292	7903
N32STAAWF	2458	2522	2553	2598	2738	2853	3404	3581
N32STHHWF	3301	3453	3525	3631	3961	4232	5532	5948
N32STLLWF	3748	3879	3942	4033	4318	4552	5675	6034
N32TAAWF	2458	2522	2553	2598	2738	2853	3404	3581
N32THHWF	3301	3453	3525	3631	3961	4232	5532	5948
N32TLLWF	3748	3879	3942	4033	4318	4552	5675	6034
N35AACF	857	880	891	907	957	998	1195	1258
N35AACSF	954	977	988	1004	1054	1095	1292	1355
N35ABCF	969	1008	1027	1054	1139	1209	1544	1651
N35ABCSF	1066	1105	1124	1151	1236	1306	1641	1748
N35ACDF	1112	1135	1146	1162	1212	1253	1450	1513
N35ACDSF	1210	1233	1244	1260	1310	1351	1548	1611
N35ACCF	1000	1023	1034	1050	1100	1141	1338	1401
N35ACCSF	1097	1120	1131	1147	1197	1238	1435	1498
N35AECSF	1226	1265	1284	1311	1396	1466	1801	1908
N35AECSF	1323	1362	1381	1408	1493	1563	1898	2005
N35AECF	1113	1152	1171	1198	1283	1353	1688	1795
N35AECSF	1209	1248	1267	1294	1379	1449	1784	1891
N35AJCF	1082	1105	1116	1132	1182	1223	1420	1483
N35AJCSF	1178	1201	1212	1228	1278	1319	1516	1579
N35AMCF	1194	1233	1252	1279	1364	1434	1769	1876
N35AMCSF	1292	1331	1350	1377	1462	1532	1867	1974
N35AOCDF	1219	1244	1256	1274	1329	1374	1591	1660
N35AOCDSF	1307	1332	1344	1362	1417	1462	1679	1748
N35AOCF	1106	1131	1143	1161	1216	1261	1478	1547
N35AOCFSF	1195	1220	1232	1250	1305	1350	1567	1636
N35APCDF	1319	1358	1377	1404	1489	1559	1894	2001
N35APCDSF	1409	1448	1467	1494	1579	1649	1984	2091
N35APCF	1206	1245	1264	1291	1376	1446	1781	1888

TB133

National Seating Fabric TB133 Fire Rated Pricing

Model Number	TB133 Fabric Grades							
	1	2/COM	3	4	6	7	L7	L8
N35APCSF	\$ 1297	\$ 1336	\$ 1355	\$ 1382	\$ 1467	\$ 1537	\$ 1872	\$ 1979
N35ASCF	1128	1153	1165	1183	1238	1283	1500	1569
N35ASCSF	1219	1244	1256	1274	1329	1374	1591	1660
N35ATCF	1229	1268	1287	1314	1399	1469	1804	1911
N35ATCSF	1325	1364	1383	1410	1495	1565	1900	2007
N35BACF	764	787	798	814	864	905	1102	1165
N35BACSF	861	884	895	911	961	1002	1199	1262
N35BBCF	879	918	937	964	1049	1119	1454	1561
N35BBCSF	974	1013	1032	1059	1144	1214	1549	1656
N35BCCDF	1020	1043	1054	1070	1120	1161	1358	1421
N35BCCDSF	1116	1139	1150	1166	1216	1257	1454	1517
N35BCCF	908	931	942	958	1008	1049	1246	1309
N35BCCSF	1004	1027	1038	1054	1104	1145	1342	1405
N35BECDF	1134	1173	1192	1219	1304	1374	1709	1816
N35BECDSF	1230	1269	1288	1315	1400	1470	1805	1912
N35BECF	1021	1060	1079	1106	1191	1261	1596	1703
N35BECFSF	1118	1157	1176	1203	1288	1358	1693	1800
N35BJCF	989	1012	1023	1039	1089	1130	1327	1390
N35BJCSF	1086	1109	1120	1136	1186	1227	1424	1487
N35BMCF	1103	1142	1161	1188	1273	1343	1678	1785
N35BMCSF	1199	1238	1257	1284	1369	1439	1774	1881
N35BOCDF	1122	1147	1159	1177	1232	1277	1494	1563
N35BOCDSF	1219	1244	1256	1274	1329	1374	1591	1660
N35BOCF	1010	1035	1047	1065	1120	1165	1382	1451
N35BOCSF	1106	1131	1143	1161	1216	1261	1478	1547
N35BPCDF	1223	1262	1281	1308	1393	1463	1798	1905
N35BPCDSF	1319	1358	1377	1404	1489	1559	1894	2001
N35BPCF	1110	1149	1168	1195	1280	1350	1685	1792
N35BPSCF	1206	1245	1264	1291	1376	1446	1781	1888
N35BSCF	1027	1052	1064	1082	1137	1182	1399	1468
N35BSCSF	1128	1153	1165	1183	1238	1283	1500	1569
N35BTCF	1133	1172	1191	1218	1303	1373	1708	1815
N35BTCFSF	1228	1267	1286	1313	1398	1468	1803	1910
N35CACF	836	857	867	881	926	963	1140	1197
N35CBCF	937	972	988	1012	1087	1149	1444	1539
N35CCCDF	1092	1113	1123	1137	1182	1219	1396	1453
N35CCCF	979	1000	1010	1024	1069	1106	1283	1340
N35CECDF	1195	1230	1246	1270	1345	1407	1702	1797
N35CECF	1082	1117	1133	1157	1232	1294	1589	1684
N35CJCF	1060	1081	1091	1105	1150	1187	1364	1421
N35CMCF	1163	1198	1214	1238	1313	1375	1670	1765
N35COCDF	1191	1212	1222	1236	1281	1318	1495	1552
N35COCF	1077	1098	1108	1122	1167	1204	1381	1438
N35CPCDF	1291	1326	1342	1366	1441	1503	1798	1893
N35CPCF	1178	1213	1229	1253	1328	1390	1685	1780
N35CSCF	1101	1122	1132	1146	1191	1228	1405	1462
N35CTCF	1203	1238	1254	1278	1353	1415	1710	1805
N35EACF	940	961	971	985	1030	1067	1244	1301
N35EBCF	1042	1077	1093	1117	1192	1254	1549	1644
N35ECCDF	1203	1224	1234	1248	1293	1330	1507	1564
N35ECCF	1091	1112	1122	1136	1181	1218	1395	1452
N35EECDF	1306	1341	1357	1381	1456	1518	1813	1908
N35EECF	1194	1229	1245	1269	1344	1406	1701	1796
N35JACF	1283	1308	1320	1338	1393	1438	1655	1724
N35JCCF	1464	1489	1501	1519	1574	1619	1836	1905
N35MACF	1885	1945	1973	2015	2145	2252	2764	2928
N35MBCF	2067	2127	2155	2197	2327	2434	2946	3110

National Seating Fabric TB133 Fire Rated Pricing

Model Number	TB133 Fabric Grades							
	1	2/COM	3	4	6	7	L7	L8
39A-BWAAF	\$ 1538	\$ 1582	\$ 1603	\$ 1633	\$ 1728	\$ 1806	\$ 2180	\$ 2300
39A-BWAATF	1623	1667	1688	1718	1813	1891	2265	2385
39A-GRXXF	730	755	767	785	840	885	1102	1171
39A-GWXXF	815	840	852	870	925	970	1187	1256
39A-GWXXTF	901	926	938	956	1011	1056	1273	1342
39A-TAAAF	2225	2287	2317	2360	2495	2606	3138	3308
39A-TAAATF	2397	2459	2489	2532	2667	2778	3310	3480
39A-TAAF	1471	1512	1532	1561	1651	1725	2079	2193
39A-TAATF	1603	1644	1664	1693	1783	1857	2211	2325
39B-GRXXF	692	709	718	730	767	798	946	993
39B-GWXXF	773	790	799	811	848	879	1027	1074
39B-GWXXTF	864	882	891	904	944	977	1134	1185
39D-GRXXF	700	717	726	738	775	806	954	1001
39D-GWXXF	785	802	811	823	860	891	1039	1086
39D-GWXXTF	875	893	902	915	955	988	1145	1196
39E-GRXXF	734	761	773	792	850	898	1126	1199
39E-GWXXF	819	846	858	877	935	983	1211	1284
39E-GWXXTF	917	947	961	982	1047	1100	1356	1438
39H-GRXXF	734	761	773	792	850	898	1126	1199
39H-GWXXF	819	846	858	877	935	983	1211	1284
39H-GWXXTF	875	893	902	915	955	988	1145	1196
39L-GRXXF	692	709	718	730	767	798	946	993
39L-GWXXF	773	790	799	811	848	879	1027	1074
39L-GWXXTF	864	882	891	904	944	977	1134	1185
39S-GRXXF	738	755	764	776	813	844	992	1039
39S-GWXXF	822	839	848	860	897	928	1076	1123
39S-GWXXTF	911	929	938	951	991	1024	1181	1232
39U-GRXXF	744	771	783	802	860	908	1136	1209
39U-GWXXF	826	853	865	884	942	990	1218	1291
39U-GWXXTF	925	955	969	990	1055	1108	1364	1446
N45AUF	1337	1366	1380	1401	1463	1515	1763	1843
N45AURF	431	438	442	447	464	477	541	561
N45BUF	1593	1622	1636	1657	1719	1771	2019	2099
N45BURF	516	523	527	532	549	562	626	646
N45CUF	588	595	599	604	621	634	698	718
N45HUF	721	728	732	737	754	767	831	851
N45HULF	612	619	623	628	645	658	722	742
N45JUF	841	848	852	857	874	887	951	971
N45JULF	732	739	743	748	765	778	842	862
N45U1F	410	417	421	426	443	456	520	540
N45U2F	820	834	841	852	883	909	1033	1073
N45U3F	1230	1251	1262	1278	1325	1364	1550	1609
48-EKF	1795	1862	1894	1940	2085	2204	2775	2958
48-EKJF	2020	2087	2119	2165	2310	2429	3000	3183
48-EKNF	1795	1862	1894	1940	2085	2204	2775	2958
48-EKNJF	2020	2087	2119	2165	2310	2429	3000	3183
48-ESF	1632	1708	1744	1797	1962	2097	2747	2955
48-ESJF	1857	1933	1969	2022	2187	2322	2972	3180
48-ESNF	1632	1708	1744	1797	1962	2097	2747	2955
48-ESNJF	1857	1933	1969	2022	2187	2322	2972	3180
48-GCF	1276	1343	1375	1421	1566	1685	2256	2439
48-GCNF	1276	1343	1375	1421	1566	1685	2256	2439
N48GFAF	1414	1453	1472	1499	1584	1654	1989	2096
N48GFMF	1347	1386	1405	1432	1517	1587	1922	2029
N52GHACF	726	744	753	766	806	839	996	1047
N52GHAF	697	715	724	737	777	810	967	1018
N52GHMCF	697	715	724	737	777	810	967	1018

TB133

National Seating Fabric TB133 Fire Rated Pricing

Model Number	TB133 Fabric Grades							
	1	2/COM	3	4	6	7	L7	L8
N52GHMF	\$ 670	\$ 688	\$ 697	\$ 710	\$ 750	\$ 783	\$ 940	\$ 991
N55AAF	909	944	960	984	1059	1121	1416	1511
N55BBF	827	862	878	902	977	1039	1334	1429
N55CCF	857	872	879	890	923	950	1080	1122
N55DDF	775	790	797	808	841	868	998	1040
N55EEF	819	842	853	869	919	960	1157	1220
N55HHF	736	759	770	786	836	877	1074	1137
N59AAF	983	1004	1014	1028	1073	1110	1287	1344
N59AATF	1070	1091	1101	1115	1160	1197	1374	1431
N59ALF	948	969	979	993	1038	1075	1252	1309
N59BBF	1059	1087	1100	1119	1179	1228	1465	1540
N59BBTF	1144	1172	1185	1204	1264	1313	1550	1625
N59BLF	1025	1053	1066	1085	1145	1194	1431	1506
N59CCF	1052	1073	1083	1097	1142	1179	1356	1413
N59CCTF	1139	1160	1170	1184	1229	1266	1443	1500
N59CLF	1017	1038	1048	1062	1107	1144	1321	1378
N59DDF	1075	1096	1106	1120	1165	1202	1379	1436
N59DDTF	1160	1181	1191	1205	1250	1287	1464	1521
N59DLF	1041	1062	1072	1086	1131	1168	1345	1402
N59HHF	1109	1130	1140	1154	1199	1236	1413	1470
N59HHTF	1194	1215	1225	1239	1284	1321	1498	1555
N59HLF	1075	1096	1106	1120	1165	1202	1379	1436
N59JJF	1142	1167	1179	1197	1252	1297	1514	1583
N59JJTF	1229	1254	1266	1284	1339	1384	1601	1670
N59JLF	1107	1132	1144	1162	1217	1262	1479	1548
N59KKF	1722	1743	1753	1767	1812	1849	2026	2083
N59KTF	1809	1830	1840	1854	1899	1936	2113	2170
N59MMF	1722	1757	1773	1797	1872	1934	2229	2324
N59MMTF	1809	1844	1860	1884	1959	2021	2316	2411
N59PPF	1801	1833	1849	1871	1941	1998	2274	2362
N59PTF	1887	1919	1935	1957	2027	2084	2360	2448
N60AAF	415	436	446	460	505	542	719	776
N60AWF	670	691	701	715	760	797	974	1031
N60BBF	388	409	419	433	478	515	692	749
N60BWF	644	665	675	689	734	771	948	1005
N60CCF	482	505	516	532	582	623	820	883
N60CWF	670	691	701	715	760	797	974	1031
N60DDF	454	477	488	504	554	595	792	855
N60DWF	644	665	675	689	734	771	948	1005
N60EEF	1091	1128	1145	1171	1251	1317	1632	1733
N60EMF	893	921	934	953	1013	1062	1299	1374
N60EMWF	1107	1125	1134	1147	1187	1220	1377	1428
N60EWF	1328	1365	1382	1408	1488	1554	1869	1970
N60GGF	1148	1185	1202	1228	1308	1374	1689	1790
N60GMF	951	979	992	1011	1071	1120	1357	1432
N60GMWF	1107	1125	1134	1147	1187	1220	1377	1428
N60GWF	1328	1365	1382	1408	1488	1554	1869	1970
N60PMF	893	921	934	953	1013	1062	1299	1374
N60PMWF	1107	1125	1134	1147	1187	1220	1377	1428
N60PPF	1091	1128	1145	1171	1251	1317	1632	1733
N60PWF	1328	1365	1382	1408	1488	1554	1869	1970
N60RMF	951	979	992	1011	1071	1120	1357	1432
N60RMWF	1107	1125	1134	1147	1187	1220	1377	1428
N60RRF	1148	1185	1202	1228	1308	1374	1689	1790
N60RWF	1328	1365	1382	1408	1488	1554	1869	1970
N60SAACF	474	495	505	519	564	601	778	835
N60SAAF	502	523	533	547	592	629	806	863

National Seating Fabric TB133 Fire Rated Pricing

Model Number	TB133 Fabric Grades							
	1	2/COM	3	4	6	7	L7	L8
N60SAWCF	\$ 728	\$ 749	\$ 759	\$ 773	\$ 818	\$ 855	\$ 1032	\$ 1089
N60SAWF	758	779	789	803	848	885	1062	1119
N60SBBCF	446	467	477	491	536	573	750	807
N60SBBF	475	496	506	520	565	602	779	836
N60SBWCF	702	723	733	747	792	829	1006	1063
N60SBWCF	731	752	762	776	821	858	1035	1092
N60SCCCF	540	563	574	590	640	681	878	941
N60SCCF	569	592	603	619	669	710	907	970
N60SCWCF	728	749	759	773	818	855	1032	1089
N60SCWF	758	779	789	803	848	885	1062	1119
N60SDDCF	512	535	546	562	612	653	850	913
N60SDDF	542	565	576	592	642	683	880	943
N60SDWCF	702	723	733	747	792	829	1006	1063
N60SDWF	731	752	762	776	821	858	1035	1092
N60SEEF	1179	1216	1233	1259	1339	1405	1720	1821
N60SEEF	1414	1451	1468	1494	1574	1640	1955	2056
N60SEMF	981	1009	1022	1041	1101	1150	1387	1462
N60SEMWF	1195	1213	1222	1235	1275	1308	1465	1516
N60SFAF	759	780	790	804	849	886	1063	1120
N60SFAWF	1007	1028	1038	1052	1097	1134	1311	1368
N60SFBF	733	754	764	778	823	860	1037	1094
N60SFBWF	981	1002	1012	1026	1071	1108	1285	1342
N60SFCF	825	848	859	875	925	966	1163	1226
N60SFCWF	1007	1028	1038	1052	1097	1134	1311	1368
N60SDF	799	822	833	849	899	940	1137	1200
N60SDFWF	981	1002	1012	1026	1071	1108	1285	1342
N60SGGF	1234	1271	1288	1314	1394	1460	1775	1876
N60SGGWF	1414	1451	1468	1494	1574	1640	1955	2056
N60SGMF	1039	1067	1080	1099	1159	1208	1445	1520
N60SGMWF	1195	1213	1222	1235	1275	1308	1465	1516
N60SPMF	981	1009	1022	1041	1101	1150	1387	1462
N60SPMWF	1195	1213	1222	1235	1275	1308	1465	1516
N60SPPF	1179	1216	1233	1259	1339	1405	1720	1821
N60SPPWF	1414	1451	1468	1494	1574	1640	1955	2056
N60SRMF	1039	1067	1080	1099	1159	1208	1445	1520
N60SRMWF	1195	1213	1222	1235	1275	1308	1465	1516
N60SRRF	1234	1271	1288	1314	1394	1460	1775	1876
N60SRRWF	1414	1451	1468	1494	1574	1640	1955	2056
N60STAF	759	780	790	804	849	886	1063	1120
N60STAWF	1007	1028	1038	1052	1097	1134	1311	1368
N60STBF	733	754	764	778	823	860	1037	1094
N60STBWF	981	1002	1012	1026	1071	1108	1285	1342
N60STCF	825	848	859	875	925	966	1163	1226
N60STCWF	1007	1028	1038	1052	1097	1134	1311	1368
N60STDF	799	822	833	849	899	940	1137	1200
N60STDWF	981	1002	1012	1026	1071	1108	1285	1342
62X-AUXXF	2753	2960	3059	3203	3653	4022	5795	6362
62X-GUXXF	940	989	1013	1048	1155	1243	1667	1802
62X-LUXXF	2155	2307	2379	2485	2815	3086	4386	4802
62X-UUXXF	1659	1774	1829	1909	2159	2364	3349	3664
64X-GWXXF	859	890	905	927	995	1051	1319	1404
N65AAAF	1740	1784	1805	1835	1930	2008	2382	2502
N65AAPF	1565	1609	1630	1660	1755	1833	2207	2327
N65AASAF	1832	1876	1897	1927	2022	2100	2474	2594
N65AASPF	1656	1700	1721	1751	1846	1924	2298	2418
N65BBAF	1673	1714	1734	1763	1853	1927	2281	2395
N65BBPF	1497	1538	1558	1587	1677	1751	2105	2219

TB133

National Seating Fabric TB133 Fire Rated Pricing

Model Number	TB133 Fabric Grades							
	1	2/COM	3	4	6	7	L7	L8
N65BBSAF	\$ 1764	\$ 1805	\$ 1825	\$ 1854	\$ 1944	\$ 2018	\$ 2372	\$ 2486
N65BBSPF	1588	1629	1649	1678	1768	1842	2196	2310
N65CCAF	1652	1696	1717	1747	1842	1920	2294	2414
N65CCPF	1476	1520	1541	1571	1666	1744	2118	2238
N65CCSAF	1743	1787	1808	1838	1933	2011	2385	2505
N65CCSPF	1569	1613	1634	1664	1759	1837	2211	2331
N65DDAF	1585	1626	1646	1675	1765	1839	2193	2307
N65DDPF	1410	1451	1471	1500	1590	1664	2018	2132
N65DDSAF	1676	1717	1737	1766	1856	1930	2284	2398
N65DDSPF	1500	1541	1561	1590	1680	1754	2108	2222
N65EEAF	1148	1171	1182	1198	1248	1289	1486	1549
N65EEPF	1044	1067	1078	1094	1144	1185	1382	1445
N65GGAF	1203	1226	1237	1253	1303	1344	1541	1604
N65GGPF	1098	1121	1132	1148	1198	1239	1436	1499
N66RD16CF	576	601	613	631	686	731	948	1017
N66RD16CXF								
N66RD16GF	556	581	593	611	666	711	928	997
N66RD16GXF								
N66RD18CF	630	657	670	690	749	798	1032	1107
N66RD18GF	610	637	650	670	729	778	1012	1087
N66RD22CF	682	712	727	748	813	867	1125	1207
N66RD22GF	661	691	706	727	792	846	1104	1186
N66SQ16CF	602	627	639	657	712	757	974	1043
N66SQ16CXF								
N66SQ16GF	581	606	618	636	691	736	953	1022
N66SQ16GXF								
N66SQ18CF	703	745	765	794	884	958	1315	1429
N66SQ18GF	682	724	744	773	863	937	1294	1408
N66SQ22CF	751	794	815	846	940	1017	1390	1509
N66SQ22GF	731	774	795	826	920	997	1370	1489
N66TZ16CF	676	699	710	726	776	817	1014	1077
N66TZ16CXF								
N66TZ16GF	656	679	690	706	756	797	994	1057
N66TZ16GXF								
N66TZ18CF	767	792	804	822	877	922	1139	1208
N66TZ18CXF								
N66TZ18GF	746	771	783	801	856	901	1118	1187
N66TZ18GXF								
N66TZ22CF	834	866	882	904	974	1031	1307	1395
N66TZ22CXF								
N66TZ22GF	813	845	861	883	953	1010	1286	1374
N66TZ22GXF								
N67AACF								
N67BBCF								
N67BBCJF								
N67CCCF								
N67DDCF								
N67DDCJF								
N67EEF								
N68AACF								
N68BBCF								
N68BBCJF								
N68CCCF								
N68DDCF								
N68DDCJF								
N68EEF								
N69AACF								

National Seating Fabric TB133 Fire Rated Pricing

Model Number	TB133 Fabric Grades							
	1	2/COM	3	4	6	7	L7	L8
N69BBCF	\$	\$	\$	\$	\$	\$	\$	\$
N69BBCJF								
N69CCCF								
N69DDCF								
N69DDCJF								
N69EEF								
72X-GUXTF	773	801	814	833	893	942	1179	1254
72X-GUXXF	769	797	810	829	889	938	1175	1250
N75BACF	1128	1181	1206	1243	1358	1452	1905	2050
N75BBCF	1307	1360	1385	1422	1537	1631	2084	2229
N75BCCF	1093	1144	1168	1203	1313	1403	1837	1975
N75BDCF	1274	1325	1349	1384	1494	1584	2018	2156
N75SACF	1278	1331	1356	1393	1508	1602	2055	2200
N75SBCF	1386	1439	1464	1501	1616	1710	2163	2308
N75SCCF	1242	1293	1317	1352	1462	1552	1986	2124
N75SDCF	1350	1401	1425	1460	1570	1660	2094	2232
N75SPCF	1171	1222	1246	1281	1391	1481	1915	2053
N75SSCF	1205	1258	1283	1320	1435	1529	1982	2127
N75WSF	844	874	888	909	974	1027	1283	1365
N78AFLAUF	1307	1342	1358	1382	1457	1519	1814	1909
N78AFLAWF	1439	1471	1487	1509	1579	1636	1912	2000
N78AFLMUF	1223	1258	1274	1298	1373	1435	1730	1825
N78AFLMWF	1356	1388	1404	1426	1496	1553	1829	1917
N78AFRAUF	1307	1342	1358	1382	1457	1519	1814	1909
N78AFRAWF	1439	1471	1487	1509	1579	1636	1912	2000
N78AFRMUF	1223	1258	1274	1298	1373	1435	1730	1825
N78AFRMWF	1356	1388	1404	1426	1496	1553	1829	1917
N78B2AUF	2711	2775	2806	2851	2991	3106	3657	3834
N78B2AWF	2960	3015	3042	3080	3200	3298	3771	3922
N78B2EUF	2654	2718	2749	2794	2934	3049	3600	3777
N78B2EWF	2903	2958	2985	3023	3143	3241	3714	3865
N78B3AUF	4002	4096	4141	4207	4412	4580	5388	5646
N78B3AWF	4391	4476	4517	4576	4761	4913	5642	5875
N78B3EUF	3946	4040	4085	4151	4356	4524	5332	5590
N78B3EWF	4334	4419	4460	4519	4704	4856	5585	5818
N78D1MF	1021	1046	1058	1076	1131	1176	1393	1462
N78D2AF	1727	1768	1788	1817	1907	1981	2335	2449
N78D2MF	1332	1373	1393	1422	1512	1586	1940	2054
N78D3AF	2182	2233	2257	2292	2402	2492	2926	3064
N78D3MF	1761	1812	1836	1871	1981	2071	2505	2643
N78GEAUF	2061	2109	2132	2166	2271	2357	2771	2903
N78GEAWF	2243	2287	2308	2338	2433	2511	2885	3005
N78GFAUF	1335	1370	1386	1410	1485	1547	1842	1937
N78GFAWF	1468	1500	1516	1538	1608	1665	1941	2029
N78GFMUF	1252	1287	1303	1327	1402	1464	1759	1854
N78GFMWF	1385	1417	1433	1455	1525	1582	1858	1946
N78LAAAUBF	5085	5260	5343	5465	5845	6157	7654	8133
N78LAAAUF	4577	4752	4835	4957	5337	5649	7146	7625
N78LAAAULF	4831	5006	5089	5211	5591	5903	7400	7879
N78LAAAURF	4831	5006	5089	5211	5591	5903	7400	7879
N78LAAAUBF	5522	5697	5780	5902	6282	6594	8091	8570
N78LAAAUF	5017	5192	5275	5397	5777	6089	7586	8065
N78LAAAULF	5269	5444	5527	5649	6029	6341	7838	8317
N78LAAAURF	5269	5444	5527	5649	6029	6341	7838	8317
N78LAAUBF	3887	4011	4071	4157	4427	4648	5712	6052
N78LAAUF	3380	3504	3564	3650	3920	4141	5205	5545
N78LAAULF	3634	3758	3818	3904	4174	4395	5459	5799

TB133

National Seating Fabric TB133 Fire Rated Pricing

Model Number	TB133 Fabric Grades							
	1	2/COM	3	4	6	7	L7	L8
N78LAAURF	\$ 3634	\$ 3758	\$ 3818	\$ 3904	\$ 4174	\$ 4395	\$ 5459	\$ 5799
N78LAAWBF	4142	4259	4315	4397	4652	4861	5866	6187
N78LAAWF	3636	3753	3809	3891	4146	4355	5360	5681
N78LAAWLF	3889	4006	4062	4144	4399	4608	5613	5934
N78LAAWRF	3889	4006	4062	4144	4399	4608	5613	5934
N78LAUF	2239	2313	2348	2399	2559	2690	3321	3522
N78LAULF	2492	2566	2601	2652	2812	2943	3574	3775
N78LAURF	2492	2566	2601	2652	2812	2943	3574	3775
N78LAWF	2362	2431	2464	2512	2662	2785	3376	3565
N78LAWLF	2616	2685	2718	2766	2916	3039	3630	3819
N78LAWRF	2616	2685	2718	2766	2916	3039	3630	3819
N78LBUBF	3462	3570	3622	3697	3932	4125	5051	5347
N78LBUFF	2955	3063	3115	3190	3425	3618	4544	4840
N78LBULF	3209	3317	3369	3444	3679	3872	4798	5094
N78LBURF	3209	3317	3369	3444	3679	3872	4798	5094
N78LBWBF	3719	3820	3869	3939	4159	4339	5206	5483
N78LBWF	3212	3313	3362	3432	3652	3832	4699	4976
N78LBWLF	3466	3567	3616	3686	3906	4086	4953	5230
N78LBWRF	3466	3567	3616	3686	3906	4086	4953	5230
N78LCUBF	4252	4399	4470	4572	4892	5154	6415	6818
N78LCUF	3746	3893	3964	4066	4386	4648	5909	6312
N78LCULF	3999	4146	4217	4319	4639	4901	6162	6565
N78LCURF	3999	4146	4217	4319	4639	4901	6162	6565
N78LCWBF	4693	4833	4900	4998	5303	5553	6755	7139
N78LCWF	4187	4327	4394	4492	4797	5047	6249	6633
N78LCWLF	4440	4580	4647	4745	5050	5300	6502	6886
N78LCWRF	4440	4580	4647	4745	5050	5300	6502	6886
N78LEUF	2539	2633	2678	2744	2949	3117	3925	4183
N78LEWF	2712	2799	2841	2902	3092	3248	3996	4236
N78PAUF	1559	1600	1620	1649	1739	1813	2167	2281
N78SFAUF	1447	1482	1498	1522	1597	1659	1954	2049
N78SFAWF	1581	1613	1629	1651	1721	1778	2054	2142
N78SFMUF	1364	1399	1415	1439	1514	1576	1871	1966
N78SFMWF	1497	1529	1545	1567	1637	1694	1970	2058
N78T2AUF	2682	2746	2777	2822	2962	3077	3628	3805
N78T2AWF	2932	2987	3014	3052	3172	3270	3743	3894
N78T3AUF	3975	4069	4114	4180	4385	4553	5361	5619
N78T3AWF	4363	4448	4489	4548	4733	4885	5614	5847
N79AACF	1056	1100	1121	1151	1246	1324	1698	1818
N79AACJF	1281	1325	1346	1376	1471	1549	1923	2043
N79BBCF	1008	1047	1066	1093	1178	1248	1583	1690
N79BBCJF	1233	1272	1291	1318	1403	1473	1808	1915
N79CCF	841	880	899	926	1011	1081	1416	1523
N85CACF	1451	1490	1509	1536	1621	1691	2026	2133
N85CBCF	1402	1439	1456	1482	1562	1628	1943	2044
N85LAF	2286	2350	2381	2426	2566	2681	3232	3409
N85LATF	2403	2467	2498	2543	2683	2798	3349	3526
N85LBF	2933	3026	3070	3135	3336	3501	4295	4549
N85LBTF	3050	3143	3187	3252	3453	3618	4412	4666
N85LCF	3636	3756	3813	3896	4156	4369	5394	5721
N85LCTF	3754	3874	3931	4014	4274	4487	5512	5839
N85LDF	1848	1906	1933	1973	2098	2201	2693	2851
N85LDTF	1965	2023	2050	2090	2215	2318	2810	2968
N85SAAF	2597	2655	2682	2722	2847	2950	3442	3600
N85SAAATF	2769	2827	2854	2894	3019	3122	3614	3772
N85SAAF	1725	1762	1779	1805	1885	1951	2266	2367
N85SAAATF	1855	1892	1909	1935	2015	2081	2396	2497

National Seating Fabric TB133 Fire Rated Pricing

Model Number	TB133 Fabric Grades							
	1	2/COM	3	4	6	7	L7	L8
N85SACAF	\$ 2658	\$ 2713	\$ 2740	\$ 2778	\$ 2898	\$ 2996	\$ 3469	\$ 3620
N85SACATF	2830	2885	2912	2950	3070	3168	3641	3792
N85SAF	936	954	963	976	1016	1049	1206	1257
N85SATF	1022	1040	1049	1062	1102	1135	1292	1343
N85SBF	1012	1037	1049	1067	1122	1167	1384	1453
N85SBTF	1097	1122	1134	1152	1207	1252	1469	1538
N85SCF	1005	1023	1032	1045	1085	1118	1275	1326
N85SCTF	1092	1110	1119	1132	1172	1205	1362	1413
N85SEF	1795	1839	1860	1890	1985	2063	2437	2557
N85SETF	1882	1926	1947	1977	2072	2150	2524	2644
88X-ENFXCF								
88X-ENFXCJF								
88X-GMXXF								
88X-GRXXF								
88X-MNFXCF								
88X-MNFXCJF								
88X-MRFXCF								
88X-MRFXCJF								
89X-EUEXCF	1217	1266	1290	1325	1432	1520	1944	2079
89X-EUFXCF	1138	1187	1211	1246	1353	1441	1865	2000
89X-EUFXCJF	1363	1412	1436	1471	1578	1666	2090	2225
89X-EWECCF	1345	1386	1406	1435	1525	1599	1953	2067
89X-EWECCJF	1570	1611	1631	1660	1750	1824	2178	2292
89X-EWEXCF	1285	1326	1346	1375	1465	1539	1893	2007
89X-EWEXCJF	1510	1551	1571	1600	1690	1764	2118	2232
89X-GWXXF	868	903	919	943	1018	1080	1375	1470
89X-MUEXCF	1179	1225	1247	1279	1379	1461	1855	1981
89X-MUFXCF	1100	1146	1168	1200	1300	1382	1776	1902
89X-MUFXCJF	1325	1371	1393	1425	1525	1607	2001	2127
89X-MWECCF	1299	1336	1353	1379	1459	1525	1840	1941
89X-MWECCJF	1524	1561	1578	1604	1684	1750	2065	2166
89X-MWEXCF	1239	1276	1293	1319	1399	1465	1780	1881
89X-MWEXCJF	1464	1501	1518	1544	1624	1690	2005	2106
N90AAF	2325	2435	2488	2565	2805	3002	3947	4250
N90BBF	3128	3319	3410	3543	3958	4298	5933	6456
N90CCF	3761	3970	4070	4216	4671	5044	6837	7410
N92B1F	1468	1530	1560	1603	1738	1849	2381	2551
N92B2F	2009	2110	2159	2229	2449	2629	3496	3773
N92B3F	2549	2689	2756	2854	3159	3409	4611	4995
N92B9F	2042	2109	2141	2187	2332	2451	3022	3205
N92CSACF	2336	2417	2455	2511	2686	2830	3519	3740
N92CSAF	2336	2417	2455	2511	2686	2830	3519	3740
N92CSALCF	2575	2656	2694	2750	2925	3069	3758	3979
N92CSALF	2575	2656	2694	2750	2925	3069	3758	3979
N92CSARCF	2575	2656	2694	2750	2925	3069	3758	3979
N92CSARF	2575	2656	2694	2750	2925	3069	3758	3979
N92CSLLCF	2275	2339	2370	2415	2555	2670	3221	3398
N92CSLLF	2275	2339	2370	2415	2555	2670	3221	3398
N92CSMCF	1767	1822	1849	1887	2007	2105	2578	2729
N92CSMF	1767	1822	1849	1887	2007	2105	2578	2729
N92CSRRCF	2275	2339	2370	2415	2555	2670	3221	3398
N92CSRRF	2275	2339	2370	2415	2555	2670	3221	3398
N92H1BF	3215	3392	3477	3600	3985	4301	5818	6303
N92H1BHF	3818	4062	4178	4348	4878	5313	7401	8069
N92H1BLF	3453	3630	3715	3838	4223	4539	6056	6541
N92H1BMF	3650	3862	3963	4110	4570	4947	6760	7339
N92H1BRF	3453	3630	3715	3838	4223	4539	6056	6541

National Seating Fabric TB133 Fire Rated Pricing

Model Number	TB133 Fabric Grades							
	1	2/COM	3	4	6	7	L7	L8
N92H1LF	\$ 2858	\$ 3003	\$ 3072	\$ 3173	\$ 3488	\$ 3746	\$ 4987	\$ 5384
N92H1LHF	3164	3343	3429	3554	3944	4264	5800	6292
N92H1LLF	3097	3242	3311	3412	3727	3985	5226	5623
N92H1LMF	3079	3242	3320	3434	3789	4080	5479	5926
N92H1MF	2510	2625	2680	2760	3010	3215	4200	4515
N92H1RF	2858	3003	3072	3173	3488	3746	4987	5384
N92H1RHF	3164	3343	3429	3554	3944	4264	5800	6292
N92H1RMF	3079	3242	3320	3434	3789	4080	5479	5926
N92H1RRF	3097	3242	3311	3412	3727	3985	5226	5623
N92H2BBF	5257	5522	5648	5832	6407	6879	9144	9869
N92H2BF	4780	5045	5171	5355	5930	6402	8667	9392
N92H2BHF	5393	5727	5886	6118	6843	7438	10294	11208
N92H2BLF	5019	5284	5410	5594	6169	6641	8906	9631
N92H2BMF	5223	5524	5668	5878	6533	7070	9651	10476
N92H2BRF	5019	5284	5410	5594	6169	6641	8906	9631
N92H2LF	4432	4667	4779	4942	5452	5870	7880	8522
N92H2LHF	4738	5007	5136	5323	5908	6388	8693	9430
N92H2LLF	4671	4906	5018	5181	5691	6109	8119	8761
N92H2LMF	4654	4907	5028	5204	5754	6205	8372	9065
N92H2MF	4084	4289	4387	4529	4974	5339	7092	7653
N92H2RF	4432	4667	4779	4942	5452	5870	7880	8522
N92H2RHF	4738	5007	5136	5323	5908	6388	8693	9430
N92H2RMF	4654	4907	5028	5204	5754	6205	8372	9065
N92H2RRF	4671	4906	5018	5181	5691	6109	8119	8761
N92H3BBF	6832	7186	7356	7602	8372	9003	12037	13007
N92H3BF	6354	6708	6878	7124	7894	8525	11559	12529
N92H3BHF	6967	7390	7593	7887	8807	9561	13186	14345
N92H3BLF	6593	6947	7117	7363	8133	8764	11798	12768
N92H3BMF	6797	7188	7375	7647	8497	9194	12543	13614
N92H3BRF	6593	6947	7117	7363	8133	8764	11798	12768
N92H3LF	6005	6329	6484	6710	7415	7993	10771	11659
N92H3LHF	6312	6671	6842	7092	7872	8512	11585	12568
N92H3LLF	6244	6568	6723	6949	7654	8232	11010	11898
N92H3LMF	6228	6571	6735	6973	7718	8329	11264	12203
N92H3MF	5651	5943	6083	6286	6921	7442	9944	10744
N92H3RF	6005	6329	6484	6710	7415	7993	10771	11659
N92H3RHF	6312	6671	6842	7092	7872	8512	11585	12568
N92H3RMF	6228	6571	6735	6973	7718	8329	11264	12203
N92H3RRF	6244	6568	6723	6949	7654	8232	11010	11898
N92HC2F	6155	6367	6468	6615	7075	7452	9265	9844
N92HC3F	8712	9080	9256	9512	10312	10968	14120	15128
N92HIN9F	3592	3735	3803	3902	4212	4466	5688	6078
N92HOU9F	3491	3606	3661	3741	3991	4196	5181	5496
N92HSQ9DF	3295	3422	3482	3570	3845	4071	5154	5501
N92HSQ9LF	3261	3378	3434	3516	3771	3980	4985	5306
N92HSQ9RF	3261	3378	3434	3516	3771	3980	4985	5306
N92HTL2BBF	6610	6780	6862	6980	7350	7653	9111	9577
N92HTL2BF	6134	6304	6386	6504	6874	7177	8635	9101
N92HTL2BHF	6905	7188	7323	7520	8135	8639	11062	11837
N92HTL2BLF	6372	6542	6624	6742	7112	7415	8873	9339
N92HTL2BMF	6737	6988	7108	7282	7827	8274	10421	11108
N92HTL2BRF	6372	6542	6624	6742	7112	7415	8873	9339
N92HTL2LF	5953	6139	6228	6358	6763	7095	8691	9201
N92HTL2LHF	6251	6470	6574	6726	7201	7591	9462	10061
N92HTL2LLF	6192	6378	6467	6597	7002	7334	8930	9440
N92HTL2LMF	6166	6368	6465	6606	7046	7407	9140	9695
N92HTL2MF	5597	5751	5825	5932	6267	6542	7862	8284

National Seating Fabric TB133 Fire Rated Pricing

Model Number	TB133 Fabric Grades							
	1	2/COM	3	4	6	7	L7	L8
N92HTL2RF	\$ 5953	\$ 6139	\$ 6228	\$ 6358	\$ 6763	\$ 7095	\$ 8691	\$ 9201
N92HTL2RHF	6251	6470	6574	6726	7201	7591	9462	10061
N92HTL2RMF	6166	6368	6465	6606	7046	7407	9140	9695
N92HTL2RRF	6192	6378	6467	6597	7002	7334	8930	9440
N92HTL3BBF	8587	8870	9005	9202	9817	10321	12744	13519
N92HTL3BF	8109	8392	8527	8724	9339	9843	12266	13041
N92HTL3BHF	8714	9064	9231	9474	10234	10857	13852	14809
N92HTL3BLF	8348	8631	8766	8963	9578	10082	12505	13280
N92HTL3BMF	8536	8851	9002	9221	9906	10468	13167	14030
N92HTL3BRF	8348	8631	8766	8963	9578	10082	12505	13280
N92HTL3LF	7753	8004	8124	8298	8843	9290	11437	12124
N92HTL3LHF	8050	8333	8468	8665	9280	9784	12207	12982
N92HTL3LLF	7992	8243	8363	8537	9082	9529	11676	12363
N92HTL3LMF	7975	8244	8373	8560	9145	9625	11930	12667
N92HTL3MF	7405	7626	7731	7885	8365	8759	10650	11255
N92HTL3RF	7753	8004	8124	8298	8843	9290	11437	12124
N92HTL3RHF	8050	8333	8468	8665	9280	9784	12207	12982
N92HTL3RMF	7975	8244	8373	8560	9145	9625	11930	12667
N92HTL3RRF	7992	8243	8363	8537	9082	9529	11676	12363
N92HTLC2F	7458	7575	7631	7713	7968	8177	9182	9503
N92HTLC3F	9999	10155	10230	10339	10679	10958	12297	12726
N92HTLIN9F	5080	5179	5226	5295	5510	5686	6533	6804
N92HTLSQ9DF	4758	4834	4870	4923	5088	5223	5873	6081
N92HTLSQ9LF	4733	4802	4835	4883	5033	5156	5747	5936
N92HTLSQ9RF	4733	4802	4835	4883	5033	5156	5747	5936
N92HTU2BBF	6106	6371	6497	6681	7256	7728	9993	10718
N92HTU2BF	5629	5894	6020	6204	6779	7251	9516	10241
N92HTU2BHF	6241	6575	6734	6966	7691	8286	11142	12056
N92HTU2BLF	5868	6133	6259	6443	7018	7490	9755	10480
N92HTU2BMF	6072	6373	6517	6727	7382	7919	10500	11325
N92HTU2BRF	5868	6133	6259	6443	7018	7490	9755	10480
N92HTU2LF	5281	5516	5628	5791	6301	6719	8729	9371
N92HTU2LHF	5587	5856	5985	6172	6757	7237	9542	10279
N92HTU2LLF	5520	5755	5867	6030	6540	6958	8968	9610
N92HTU2LMF	5502	5755	5876	6052	6602	7053	9220	9913
N92HTU2MF	4933	5138	5236	5378	5823	6188	7941	8502
N92HTU2RF	5281	5516	5628	5791	6301	6719	8729	9371
N92HTU2RHF	5587	5856	5985	6172	6757	7237	9542	10279
N92HTU2RMF	5502	5755	5876	6052	6602	7053	9220	9913
N92HTU2RRF	5520	5755	5867	6030	6540	6958	8968	9610
N92HTU3BBF	7575	7929	8099	8345	9115	9746	12780	13750
N92HTU3BF	7097	7451	7621	7867	8637	9268	12302	13272
N92HTU3BHF	7710	8133	8336	8630	9550	10304	13929	15088
N92HTU3BLF	7336	7690	7860	8106	8876	9507	12541	13511
N92HTU3BMF	7540	7931	8118	8390	9240	9937	13286	14357
N92HTU3BRF	7336	7690	7860	8106	8876	9507	12541	13511
N92HTU3LF	6748	7072	7227	7453	8158	8736	11514	12402
N92HTU3LHF	7054	7413	7584	7834	8614	9254	12327	13310
N92HTU3LLF	6987	7311	7466	7692	8397	8975	11753	12641
N92HTU3LMF	6971	7314	7478	7716	8461	9072	12007	12946
N92HTU3MF	6393	6685	6825	7028	7663	8184	10686	11486
N92HTU3RF	6748	7072	7227	7453	8158	8736	11514	12402
N92HTU3RHF	7054	7413	7584	7834	8614	9254	12327	13310
N92HTU3RMF	6971	7314	7478	7716	8461	9072	12007	12946
N92HTU3RRF	6987	7311	7466	7692	8397	8975	11753	12641
N92HTUC2F	6979	7191	7292	7439	7899	8276	10089	10668
N92HTUC3F	9536	9904	10080	10336	11136	11792	14944	15952

TB133

National Seating Fabric TB133 Fire Rated Pricing

Model Number	TB133 Fabric Grades							
	1	2/COM	3	4	6	7	L7	L8
N92HTUIN9F	\$ 4416	\$ 4559	\$ 4627	\$ 4726	\$ 5036	\$ 5290	\$ 6512	\$ 6902
N92HTUSQ9DF	4119	4246	4306	4394	4669	4895	5978	6325
N92HTUSQ9LF	4085	4202	4258	4340	4595	4804	5809	6130
N92HTUSQ9RF	4085	4202	4258	4340	4595	4804	5809	6130
N92HTW2BBF	6610	6780	6862	6980	7350	7653	9111	9577
N92HTW2BF	6134	6304	6386	6504	6874	7177	8635	9101
N92HTW2BHF	6905	7188	7323	7520	8135	8639	11062	11837
N92HTW2BLF	6372	6542	6624	6742	7112	7415	8873	9339
N92HTW2BMF	6737	6988	7108	7282	7827	8274	10421	11108
N92HTW2BRF	6372	6542	6624	6742	7112	7415	8873	9339
N92HTW2LF	5953	6139	6228	6358	6763	7095	8691	9201
N92HTW2LHF	6251	6470	6574	6726	7201	7591	9462	10061
N92HTW2LLF	6192	6378	6467	6597	7002	7334	8930	9440
N92HTW2LMF	6166	6368	6465	6606	7046	7407	9140	9695
N92HTW2MF	5597	5751	5825	5932	6267	6542	7862	8284
N92HTW2RF	5953	6139	6228	6358	6763	7095	8691	9201
N92HTW2RHF	6251	6470	6574	6726	7201	7591	9462	10061
N92HTW2RMF	6166	6368	6465	6606	7046	7407	9140	9695
N92HTW2RRF	6192	6378	6467	6597	7002	7334	8930	9440
N92HTW3BBF	8587	8870	9005	9202	9817	10321	12744	13519
N92HTW3BF	8109	8392	8527	8724	9339	9843	12266	13041
N92HTW3BHF	8714	9064	9231	9474	10234	10857	13852	14809
N92HTW3BLF	8348	8631	8766	8963	9578	10082	12505	13280
N92HTW3BMF	8536	8851	9002	9221	9906	10468	13167	14030
N92HTW3BRF	8348	8631	8766	8963	9578	10082	12505	13280
N92HTW3LF	7753	8004	8124	8298	8843	9290	11437	12124
N92HTW3LHF	8050	8333	8468	8665	9280	9784	12207	12982
N92HTW3LLF	7992	8243	8363	8537	9082	9529	11676	12363
N92HTW3LMF	7975	8244	8373	8560	9145	9625	11930	12667
N92HTW3MF	7405	7626	7731	7885	8365	8759	10650	11255
N92HTW3RF	7753	8004	8124	8298	8843	9290	11437	12124
N92HTW3RHF	8050	8333	8468	8665	9280	9784	12207	12982
N92HTW3RMF	7975	8244	8373	8560	9145	9625	11930	12667
N92HTW3RRF	7992	8243	8363	8537	9082	9529	11676	12363
N92HTWC2F	7458	7575	7631	7713	7968	8177	9182	9503
N92HTWC3F	9999	10155	10230	10339	10679	10958	12297	12726
N92HTWIN9F	5080	5179	5226	5295	5510	5686	6533	6804
N92HTWSQ9DF	4758	4834	4870	4923	5088	5223	5873	6081
N92HTWSQ9LF	4733	4802	4835	4883	5033	5156	5747	5936
N92HTWSQ9RF	4733	4802	4835	4883	5033	5156	5747	5936
N92M1BF	2608	2764	2839	2948	3288	3567	4906	5335
N92M1BLF	2846	3002	3077	3186	3526	3805	5144	5573
N92M1BMF	3043	3234	3325	3458	3873	4213	5848	6371
N92M1BRF	2846	3002	3077	3186	3526	3805	5144	5573
N92M1LF	2260	2387	2447	2535	2810	3036	4119	4466
N92M1LLF	2499	2626	2686	2774	3049	3275	4358	4705
N92M1LMF	2474	2617	2685	2784	3094	3348	4570	4960
N92M1MF	1903	1997	2042	2108	2313	2481	3289	3547
N92M1RF	2260	2387	2447	2535	2810	3036	4119	4466
N92M1RMF	2474	2617	2685	2784	3094	3348	4570	4960
N92M1RRF	2499	2626	2686	2774	3049	3275	4358	4705
N92M2BBF	4053	4278	4386	4543	5033	5435	7365	7983
N92M2BF	3576	3801	3909	4066	4556	4958	6888	7506
N92M2BLF	3815	4040	4148	4305	4795	5197	7127	7745
N92M2BMF	4011	4271	4395	4576	5141	5604	7830	8542
N92M2BRF	3815	4040	4148	4305	4795	5197	7127	7745
N92M2LF	3220	3413	3506	3640	4060	4404	6059	6588

National Seating Fabric TB133 Fire Rated Pricing

Model Number	TB133 Fabric Grades							
	1	2/COM	3	4	6	7	L7	L8
N92M2LLF	\$ 3459	\$ 3652	\$ 3745	\$ 3879	\$ 4299	\$ 4643	\$ 6298	\$ 6827
N92M2LMF	3442	3654	3755	3902	4362	4739	6552	7131
N92M2MF	2871	3034	3112	3226	3581	3872	5271	5718
N92M2RF	3220	3413	3506	3640	4060	4404	6059	6588
N92M2RMF	3442	3654	3755	3902	4362	4739	6552	7131
N92M2RRF	3459	3652	3745	3879	4299	4643	6298	6827
N92M3BBF	5022	5316	5457	5662	6302	6827	9348	10155
N92M3BF	4544	4838	4979	5184	5824	6349	8870	9677
N92M3BLF	4783	5077	5218	5423	6063	6588	9109	9916
N92M3BMF	4979	5308	5465	5694	6409	6995	9812	10713
N92M3BRF	4783	5077	5218	5423	6063	6588	9109	9916
N92M3LF	4196	4461	4587	4771	5346	5818	8083	8808
N92M3LLF	4435	4700	4826	5010	5585	6057	8322	9047
N92M3LMF	4410	4691	4825	5020	5630	6130	8534	9302
N92M3MF	3840	4072	4183	4345	4850	5264	7254	7890
N92M3RF	4196	4461	4587	4771	5346	5818	8083	8808
N92M3RMF	4410	4691	4825	5020	5630	6130	8534	9302
N92M3RRF	4435	4700	4826	5010	5585	6057	8322	9047
N92MC2F	4424	4576	4648	4754	5084	5355	6655	7071
N92MC3F	6335	6604	6733	6920	7505	7985	10290	11027
N92MIN9F	2703	2820	2876	2958	3213	3422	4427	4748
N92MOU9F	2628	2725	2771	2838	3048	3220	4048	4312
N92MSQ9DF	2398	2497	2544	2613	2828	3004	3851	4122
N92MSQ9LF	2356	2443	2485	2546	2736	2892	3640	3880
N92MSQ9RF	2356	2443	2485	2546	2736	2892	3640	3880
N92MTL2BBF	5566	5741	5824	5946	6326	6638	8135	8614
N92MTL2BF	5089	5264	5347	5469	5849	6161	7658	8137
N92MTL2BLF	5328	5503	5586	5708	6088	6400	7897	8376
N92MTL2BMF	5524	5733	5833	5979	6434	6807	8600	9173
N92MTL2BRF	5328	5503	5586	5708	6088	6400	7897	8376
N92MTL2LF	4741	4886	4955	5056	5371	5629	6870	7267
N92MTL2LLF	4980	5125	5194	5295	5610	5868	7109	7506
N92MTL2LMF	4954	5115	5192	5304	5654	5941	7320	7761
N92MTL2MF	4393	4508	4563	4643	4893	5098	6083	6398
N92MTL2RF	4741	4886	4955	5056	5371	5629	6870	7267
N92MTL2RMF	4954	5115	5192	5304	5654	5941	7320	7761
N92MTL2RRF	4980	5125	5194	5295	5610	5868	7109	7506
N92MTL3BBF	7299	7520	7625	7779	8259	8653	10544	11149
N92MTL3BF	6821	7042	7147	7301	7781	8175	10066	10671
N92MTL3BLF	7060	7281	7386	7540	8020	8414	10305	10910
N92MTL3BMF	7256	7511	7633	7811	8366	8821	11008	11707
N92MTL3BRF	7060	7281	7386	7540	8020	8414	10305	10910
N92MTL3LF	6473	6664	6755	6888	7303	7643	9278	9801
N92MTL3LLF	6712	6903	6994	7127	7542	7882	9517	10040
N92MTL3LMF	6687	6894	6993	7137	7587	7956	9729	10296
N92MTL3MF	6118	6277	6353	6463	6808	7091	8450	8885
N92MTL3RF	6473	6664	6755	6888	7303	7643	9278	9801
N92MTL3RMF	6687	6894	6993	7137	7587	7956	9729	10296
N92MTL3RRF	6712	6903	6994	7127	7542	7882	9517	10040
N92MTLC2F	5787	5861	5896	5947	6107	6238	6869	7070
N92MTLC3F	7773	7872	7919	7988	8203	8379	9226	9497
N92MTLIN9F	3771	3842	3876	3926	4081	4208	4819	5014
N92MTLSQ9DF	3878	3931	3956	3993	4108	4202	4655	4800
N92MTLSQ9LF	3861	3909	3932	3966	4071	4157	4571	4703
N92MTLSQ9RF	3861	3909	3932	3966	4071	4157	4571	4703
N92MTU2BBF	4902	5127	5235	5392	5882	6284	8214	8832
N92MTU2BF	4425	4650	4758	4915	5405	5807	7737	8355

TB133

National Seating Fabric TB133 Fire Rated Pricing

Model Number	TB133 Fabric Grades							
	1	2/COM	3	4	6	7	L7	L8
N92MTU2BLF	\$ 4664	\$ 4889	\$ 4997	\$ 5154	\$ 5644	\$ 6046	\$ 7976	\$ 8594
N92MTU2BMF	4860	5120	5244	5425	5990	6453	8679	9391
N92MTU2BRF	4664	4889	4997	5154	5644	6046	7976	8594
N92MTU2LF	4069	4262	4355	4489	4909	5253	6908	7437
N92MTU2LLF	4308	4501	4594	4728	5148	5492	7147	7676
N92MTU2LMF	4290	4502	4603	4750	5210	5587	7400	7979
N92MTU2MF	3720	3883	3961	4075	4430	4721	6120	6567
N92MTU2RF	4069	4262	4355	4489	4909	5253	6908	7437
N92MTU2RMF	4290	4502	4603	4750	5210	5587	7400	7979
N92MTU2RRF	4308	4501	4594	4728	5148	5492	7147	7676
N92MTU3BBF	6295	6589	6730	6935	7575	8100	10621	11428
N92MTU3BF	5817	6111	6252	6457	7097	7622	10143	10950
N92MTU3BLF	6056	6350	6491	6696	7336	7861	10382	11189
N92MTU3BMF	6252	6581	6738	6967	7682	8268	11085	11986
N92MTU3BRF	6056	6350	6491	6696	7336	7861	10382	11189
N92MTU3LF	5469	5734	5860	6044	6619	7091	9356	10081
N92MTU3LLF	5708	5973	6099	6283	6858	7330	9595	10320
N92MTU3LMF	5683	5964	6098	6293	6903	7403	9807	10575
N92MTU3MF	5113	5345	5456	5618	6123	6537	8527	9163
N92MTU3RF	5469	5734	5860	6044	6619	7091	9356	10081
N92MTU3RMF	5683	5964	6098	6293	6903	7403	9807	10575
N92MTU3RRF	5708	5973	6099	6283	6858	7330	9595	10320
N92MTC2F	5248	5400	5472	5578	5908	6179	7479	7895
N92MTC3F	7159	7428	7557	7744	8329	8809	11114	11851
N92MTUIN9F	3527	3644	3700	3782	4037	4246	5251	5572
N92MTUSQ9DF	3222	3321	3368	3437	3652	3828	4675	4946
N92MTUSQ9LF	3180	3267	3309	3370	3560	3716	4464	4704
N92MTUSQ9RF	3180	3267	3309	3370	3560	3716	4464	4704
N92MTW2BBF	5566	5741	5824	5946	6326	6638	8135	8614
N92MTW2BF	5089	5264	5347	5469	5849	6161	7658	8137
N92MTW2BLF	5328	5503	5586	5708	6088	6400	7897	8376
N92MTW2BMF	5524	5733	5833	5979	6434	6807	8600	9173
N92MTW2BRF	5328	5503	5586	5708	6088	6400	7897	8376
N92MTW2LF	4741	4886	4955	5056	5371	5629	6870	7267
N92MTW2LLF	4980	5125	5194	5295	5610	5868	7109	7506
N92MTW2LMF	4954	5115	5192	5304	5654	5941	7320	7761
N92MTW2MF	4393	4508	4563	4643	4893	5098	6083	6398
N92MTW2RF	4741	4886	4955	5056	5371	5629	6870	7267
N92MTW2RMF	4954	5115	5192	5304	5654	5941	7320	7761
N92MTW2RRF	4980	5125	5194	5295	5610	5868	7109	7506
N92MTW3BBF	7299	7520	7625	7779	8259	8653	10544	11149
N92MTW3BF	6821	7042	7147	7301	7781	8175	10066	10671
N92MTW3BLF	7060	7281	7386	7540	8020	8414	10305	10910
N92MTW3BMF	7256	7511	7633	7811	8366	8821	11008	11707
N92MTW3BRF	7060	7281	7386	7540	8020	8414	10305	10910
N92MTW3LF	6473	6664	6755	6888	7303	7643	9278	9801
N92MTW3LLF	6712	6903	6994	7127	7542	7882	9517	10040
N92MTW3LMF	6687	6894	6993	7137	7587	7956	9729	10296
N92MTW3MF	6118	6277	6353	6463	6808	7091	8450	8885
N92MTW3RF	6473	6664	6755	6888	7303	7643	9278	9801
N92MTW3RMF	6687	6894	6993	7137	7587	7956	9729	10296
N92MTW3RRF	6712	6903	6994	7127	7542	7882	9517	10040
N92MTWC2F	5787	5861	5896	5947	6107	6238	6869	7070
N92MTWC3F	7773	7872	7919	7988	8203	8379	9226	9497
N92MTWIN9F	3771	3842	3876	3926	4081	4208	4819	5014
N92MTWSQ9DF	3878	3931	3956	3993	4108	4202	4655	4800
N92MTWSQ9LF	3861	3909	3932	3966	4071	4157	4571	4703

National Seating Fabric TB133 Fire Rated Pricing

Model Number	TB133 Fabric Grades							
	1	2/COM	3	4	6	7	L7	L8
N92MTWSQ9RF	\$ 3861	\$ 3909	\$ 3932	\$ 3966	\$ 4071	\$ 4157	\$ 4571	\$ 4703
N95AACF	2822	2953	3016	3107	3392	3626	4749	5108
N95AAF	2674	2805	2868	2959	3244	3478	4601	4960
N95AALCF	3045	3176	3239	3330	3615	3849	4972	5331
N95AALF	2895	3026	3089	3180	3465	3699	4822	5181
N95AARCF	3045	3176	3239	3330	3615	3849	4972	5331
N95AARF	2895	3026	3089	3180	3465	3699	4822	5181
N95BBBF	3946	4116	4198	4316	4686	4989	6447	6913
N95BBF	3502	3672	3754	3872	4242	4545	6003	6469
N95BBLF	3725	3895	3977	4095	4465	4768	6226	6692
N95BBRF	3725	3895	3977	4095	4465	4768	6226	6692
N95CCBF	4892	5101	5201	5347	5802	6175	7968	8541
N95CCF	4447	4656	4756	4902	5357	5730	7523	8096
N95CCLF	4670	4879	4979	5125	5580	5953	7746	8319
N95CCRF	4670	4879	4979	5125	5580	5953	7746	8319
N95DDCF	1672	1732	1760	1802	1932	2039	2551	2715
N95DDF	1524	1584	1612	1654	1784	1891	2403	2567
N95EEF	2090	2168	2206	2260	2430	2569	3239	3453
N95GGF	2796	2932	2997	3091	3386	3628	4790	5162
N95MACF	2094	2165	2199	2249	2404	2531	3142	3337
N95MAF	1946	2017	2051	2101	2256	2383	2994	3189
N95MALF	2290	2391	2440	2510	2730	2910	3777	4054
N95MALTF	2554	2655	2704	2774	2994	3174	4041	4318
N95MARF	2290	2391	2440	2510	2730	2910	3777	4054
N95MARTF	2554	2655	2704	2774	2994	3174	4041	4318
N95MBF	2849	3019	3101	3219	3589	3892	5350	5816
N95MBLF	3126	3266	3333	3431	3736	3986	5188	5572
N95MBLTF	3389	3529	3596	3694	3999	4249	5451	5835
N95MBRF	3126	3266	3333	3431	3736	3986	5188	5572
N95MBRTF	3389	3529	3596	3694	3999	4249	5451	5835
N95MCF	3771	3941	4023	4141	4511	4814	6272	6738
N95MCLF	4064	4255	4346	4479	4894	5234	6869	7392
N95MCLTF	4328	4519	4610	4743	5158	5498	7133	7656
N95MCRF	4064	4255	4346	4479	4894	5234	6869	7392
N95MCRTF	4328	4519	4610	4743	5158	5498	7133	7656
N95MHAF	1829	1884	1911	1949	2069	2167	2640	2791
N95MHF	1845	1905	1933	1975	2105	2212	2724	2888
N95MJAF	2117	2179	2209	2252	2387	2498	3030	3200
N95MJF	2150	2221	2255	2305	2460	2587	3198	3393
N95MKAF	2706	2777	2811	2861	3016	3143	3754	3949
N95MKF	2807	2906	2953	3022	3237	3413	4260	4531
451F	1347	1423	1459	1512	1677	1812	2462	2670
451TF	1409	1492	1531	1589	1769	1917	2626	2853
452F	1363	1439	1475	1528	1693	1828	2478	2686
452TF	1420	1503	1542	1600	1780	1928	2637	2864

Alliance Program Pricing

Alliance Program Pricing

Finishes

IM	Brighton	CW	Cordovan
NM	Natural	DW	Judicial
HN	Honey	MH	Mocha
CL	Caramel	405	Designer White
TF	Truffle	462	Cinder
AC	Autumn	792	Sable
MC	Amber	793	Acorn

To order, specify the following:

1. Chair Model Number
2. Fabric Grade Letter
3. Alliance Pattern Number and Color Number/Name
4. Finish Number (when applicable)

Sample Order Number

<u>N14KK</u>	<u>A</u>	<u>403901</u>	<u>036</u>	<u>HN</u>
Model Number	Fabric Grade Letter	Alliance Pattern Number	Alliance Color Number	Finish

Model Number

Alliance Program Price Grades

	A	B	C	D	E	F	G	H	I	J
N10PBL1806	\$ 167	\$ 181	\$ 193	\$ 205	\$ 217	\$ 232	\$ 242	\$ 256	\$ 271	\$ 284
N10PBL1806P	192	208	222	236	250	267	279	295	313	328
N10PRT1508	133	142	150	158	167	176	183	192	202	211
N10PRT1508C	144	153	161	169	178	187	194	203	213	222
N10PRT1508CP	168	180	190	200	210	222	231	242	255	266
N10PRT1508L	144	153	161	169	178	187	194	203	213	222
N10PRT1508LP	168	180	190	200	210	222	231	242	255	266
N10PRT1508P	158	170	180	190	200	212	221	232	245	256
N10PRT1508R	144	153	161	169	178	187	194	203	213	222
N10PRT1508RP	168	180	190	200	210	222	231	242	255	266
N10PSQ1414	131	145	157	170	182	197	207	221	237	250
N10PSQ1414B	152	166	178	191	203	218	228	242	258	271
N10PSQ1414BP	187	203	217	231	245	262	274	290	308	323
N10PSQ1414P	176	192	206	220	234	251	263	279	297	312
N10PWD1816	369	390	408	426	445	466	482	502	525	545
N10PWD2116	403	428	450	472	495	522	540	566	593	617
N10PWD2416	432	459	483	507	532	561	582	609	639	666
N12AAC	830	857	881	905	930	959	980	1007	1037	1064
N12AACS	925	952	976	1000	1025	1054	1075	1102	1132	1159
N12AAY	951	978	1002	1026	1051	1080	1101	1128	1158	1185
N12AR	747	774	798	822	847	876	897	924	954	981
N12ARS	842	869	893	917	942	971	992	1019	1049	1076
N12ARY	868	895	919	943	968	997	1018	1045	1075	1102
N12BBC	868	903	933	963	994	1030	1056	1090	1128	1161
N12BBCS	964	999	1029	1059	1090	1126	1152	1186	1224	1257
N12BBY	989	1024	1054	1084	1115	1151	1177	1211	1249	1282
N12BR	785	820	850	880	911	947	973	1007	1045	1078
N12BRS	881	916	946	976	1007	1043	1069	1103	1141	1174
N12BRY	907	942	972	1002	1033	1069	1095	1129	1167	1200
N12CCC	985	1012	1036	1060	1085	1114	1135	1162	1192	1219
N12CCCS	1080	1107	1131	1155	1180	1209	1230	1257	1287	1314
N12CCY	1108	1135	1159	1183	1208	1237	1258	1285	1315	1342
N12CR	902	929	953	977	1002	1031	1052	1079	1109	1136
N12CRS	997	1024	1048	1072	1097	1126	1147	1174	1204	1231
N12CRY	1024	1051	1075	1099	1124	1153	1174	1201	1231	1258
N12DDC	1027	1062	1092	1122	1153	1189	1215	1249	1287	1320
N12DDCS	1123	1158	1188	1218	1249	1285	1311	1345	1383	1416
N12DDY	1150	1185	1215	1245	1276	1312	1338	1372	1410	1443
N12DR	945	980	1010	1040	1071	1107	1133	1167	1205	1238
N12DRS	1040	1075	1105	1135	1166	1202	1228	1262	1300	1333
N12DRY	1065	1100	1130	1160	1191	1227	1253	1287	1325	1358
N12EEC	1017	1047	1073	1099	1127	1158	1180	1210	1242	1271
N12EECS	1113	1143	1169	1195	1223	1254	1276	1306	1338	1367
N12ER	935	965	991	1017	1045	1076	1098	1128	1160	1189
N12ERS	1029	1059	1085	1111	1139	1170	1192	1222	1254	1283
N12HHC	1060	1097	1129	1161	1194	1233	1260	1297	1337	1372
N12HHCS	1156	1193	1225	1257	1290	1329	1356	1393	1433	1468

Model Number	Alliance Program Price Grades									
	K	L	M	N	O	P	Q	R	S	T
N10PBL1806	\$ 306	\$ 351	\$ 378	\$ 393	\$ 407	\$ 421	\$ 436	\$ 449	\$ 464	\$ 478
N10PBL1806P	354	407	438	456	472	488	505	521	538	554
N10PRT1508	226	256	274	284	294	303	312	322	331	340
N10PRT1508C	237	267	285	295	305	314	323	333	342	351
N10PRT1508CP	284	322	344	357	369	380	392	404	416	427
N10PRT1508L	237	267	285	295	305	314	323	333	342	351
N10PRT1508LP	284	322	344	357	369	380	392	404	416	427
N10PRT1508P	274	312	334	347	359	370	382	394	406	417
N10PRT1508R	237	267	285	295	305	314	323	333	342	351
N10PRT1508RP	284	322	344	357	369	380	392	404	416	427
N10PSQ1414	273	318	346	361	376	390	404	418	433	447
N10PSQ1414B	294	339	367	382	397	411	425	439	454	468
N10PSQ1414BP	349	402	433	451	467	483	500	516	533	549
N10PSQ1414P	338	391	422	440	456	472	489	505	522	538
N10PWD1816	578	646	686	709	730	751	772	793	815	835
N10PWD2116	658	741	790	818	844	869	896	921	947	973
N10PWD2416	710	800	854	884	913	940	969	997	1026	1053
N12AAC	1108	1198	1252	1282	1311	1338	1367	1395	1424	1451
N12AACS	1203	1293	1347	1377	1406	1433	1462	1490	1519	1546
N12AAY	1229	1319	1373	1403	1432	1459	1488	1516	1545	1572
N12AR	1025	1115	1169	1199	1228	1255	1284	1312	1341	1368
N12ARS	1120	1210	1264	1294	1323	1350	1379	1407	1436	1463
N12ARY	1146	1236	1290	1320	1349	1376	1405	1433	1462	1489
N12BBC	1216	1329	1396	1434	1470	1504	1540	1575	1611	1645
N12BBCS	1312	1425	1492	1530	1566	1600	1636	1671	1707	1741
N12BBY	1337	1450	1517	1555	1591	1625	1661	1696	1732	1766
N12BR	1133	1246	1313	1351	1387	1421	1457	1492	1528	1562
N12BRS	1229	1342	1409	1447	1483	1517	1553	1588	1624	1658
N12BRY	1255	1368	1435	1473	1509	1543	1579	1614	1650	1684
N12CCC	1263	1353	1407	1437	1466	1493	1522	1550	1579	1606
N12CCCS	1358	1448	1502	1532	1561	1588	1617	1645	1674	1701
N12CCY	1386	1476	1530	1560	1589	1616	1645	1673	1702	1729
N12CR	1180	1270	1324	1354	1383	1410	1439	1467	1496	1523
N12CRS	1275	1365	1419	1449	1478	1505	1534	1562	1591	1618
N12CRY	1302	1392	1446	1476	1505	1532	1561	1589	1618	1645
N12DDC	1375	1488	1555	1593	1629	1663	1699	1734	1770	1804
N12DDCS	1471	1584	1651	1689	1725	1759	1795	1830	1866	1900
N12DDY	1498	1611	1678	1716	1752	1786	1822	1857	1893	1927
N12DR	1293	1406	1473	1511	1547	1581	1617	1652	1688	1722
N12DRS	1388	1501	1568	1606	1642	1676	1712	1747	1783	1817
N12DRY	1413	1526	1593	1631	1667	1701	1737	1772	1808	1842
N12EEC	1319	1417	1475	1508	1539	1569	1600	1630	1661	1691
N12EECS	1415	1513	1571	1604	1635	1665	1696	1726	1757	1787
N12ER	1237	1335	1393	1426	1457	1487	1518	1548	1579	1609
N12ERS	1331	1429	1487	1520	1551	1581	1612	1642	1673	1703
N12HHC	1431	1551	1623	1663	1701	1738	1777	1813	1852	1889
N12HHCS	1527	1647	1719	1759	1797	1834	1873	1909	1948	1985

Alliance Program Pricing

Finishes

IM	Brighton	CW	Cordovan
NM	Natural	DW	Judicial
HN	Honey	MH	Mocha
CL	Caramel	405	Designer White
TF	Truffle	462	Cinder
AC	Autumn	792	Sable
MC	Amber	793	Acorn

To order, specify the following:

1. Chair Model Number
2. Fabric Grade Letter
3. Alliance Pattern Number and Color Number/Name
4. Finish Number (when applicable)

Sample Order Number

<u>N14KK</u>	<u>A</u>	<u>403901</u>	<u>036</u>	<u>HN</u>
Model Number	Fabric Grade Letter	Alliance Pattern Number	Alliance Color Number	Finish

Model Number

Alliance Program Price Grades

	A	B	C	D	E	F	G	H	I	J
N12HR	\$ 977	\$ 1014	\$ 1046	\$ 1078	\$ 1111	\$ 1150	\$ 1177	\$ 1214	\$ 1254	\$ 1289
N12HRS	1071	1108	1140	1172	1205	1244	1271	1308	1348	1383
N12JJC	1006	1033	1057	1081	1106	1135	1156	1183	1213	1240
N12JJCE	1116	1143	1167	1191	1216	1245	1266	1293	1323	1350
N12JJCES	1212	1239	1263	1287	1312	1341	1362	1389	1419	1446
N12JJCS	1100	1127	1151	1175	1200	1229	1250	1277	1307	1334
N12JJY	1126	1153	1177	1201	1226	1255	1276	1303	1333	1360
N12JJYE	1236	1263	1287	1311	1336	1365	1386	1413	1443	1470
N12JR	923	950	974	998	1023	1052	1073	1100	1130	1157
N12JRE	1033	1060	1084	1108	1133	1162	1183	1210	1240	1267
N12JRES	1127	1154	1178	1202	1227	1256	1277	1304	1334	1361
N12JRS	1017	1044	1068	1092	1117	1146	1167	1194	1224	1251
N12JRY	1044	1071	1095	1119	1144	1173	1194	1221	1251	1278
N12JRYE	1154	1181	1205	1229	1254	1283	1304	1331	1361	1388
N12KKC	1046	1081	1111	1141	1172	1208	1234	1268	1306	1339
N12KKCE	1156	1191	1221	1251	1282	1318	1344	1378	1416	1449
N12KKCES	1255	1290	1320	1350	1381	1417	1443	1477	1515	1548
N12KKCS	1143	1178	1208	1238	1269	1305	1331	1365	1403	1436
N12KKY	1166	1201	1231	1261	1292	1328	1354	1388	1426	1459
N12KKYE	1276	1311	1341	1371	1402	1438	1464	1498	1536	1569
N12KR	962	997	1027	1057	1088	1124	1150	1184	1222	1255
N12KRE	1072	1107	1137	1167	1198	1234	1260	1294	1332	1365
N12KRES	1170	1205	1235	1265	1296	1332	1358	1392	1430	1463
N12KRS	1060	1095	1125	1155	1186	1222	1248	1282	1320	1353
N12KRY	1084	1119	1149	1179	1210	1246	1272	1306	1344	1377
N12KRYE	1194	1229	1259	1289	1320	1356	1382	1416	1454	1487
N12MMC	1035	1065	1091	1117	1145	1176	1198	1228	1260	1289
N12MMCE	1146	1176	1202	1228	1256	1287	1309	1339	1371	1400
N12MMCES	1241	1271	1297	1323	1351	1382	1404	1434	1466	1495
N12MMCS	1131	1161	1187	1213	1241	1272	1294	1324	1356	1385
N12MR	952	982	1008	1034	1062	1093	1115	1145	1177	1206
N12MRE	1062	1092	1118	1144	1172	1203	1225	1255	1287	1316
N12MRES	1159	1189	1215	1241	1269	1300	1322	1352	1384	1413
N12MRS	1049	1079	1105	1131	1159	1190	1212	1242	1274	1303
N12PPC	1077	1114	1146	1178	1211	1250	1277	1314	1354	1389
N12PPCE	1189	1226	1258	1290	1323	1362	1389	1426	1466	1501
N12PPCES	1283	1320	1352	1384	1417	1456	1483	1520	1560	1595
N12PPCS	1173	1210	1242	1274	1307	1346	1373	1410	1450	1485
N12PR	994	1031	1063	1095	1128	1167	1194	1231	1271	1306
N12PRE	1104	1141	1173	1205	1238	1277	1304	1341	1381	1416
N12PRES	1201	1238	1270	1302	1335	1374	1401	1438	1478	1513
N12PRS	1091	1128	1160	1192	1225	1264	1291	1328	1368	1403
N12QQ	681	713	741	769	799	832	856	888	923	954
N12RR	640	665	687	709	732	759	777	803	830	854
N13CCC	1079	1106	1130	1154	1179	1208	1229	1256	1286	1313
N13CCCS	1175	1202	1226	1250	1275	1304	1325	1352	1382	1409
N13CCY	1199	1226	1250	1274	1299	1328	1349	1376	1406	1433

Model Number	Alliance Program Price Grades									
	K	L	M	N	O	P	Q	R	S	T
N12HR	\$ 1348	\$ 1468	\$ 1540	\$ 1580	\$ 1618	\$ 1655	\$ 1694	\$ 1730	\$ 1769	\$ 1806
N12HRS	1442	1562	1634	1674	1712	1749	1788	1824	1863	1900
N12JJC	1284	1374	1428	1458	1487	1514	1543	1571	1600	1627
N12JJCE	1394	1484	1538	1568	1597	1624	1653	1681	1710	1737
N12JJCES	1490	1580	1634	1664	1693	1720	1749	1777	1806	1833
N12JJCS	1378	1468	1522	1552	1581	1608	1637	1665	1694	1721
N12JJY	1404	1494	1548	1578	1607	1634	1663	1691	1720	1747
N12JJYE	1514	1604	1658	1688	1717	1744	1773	1801	1830	1857
N12JR	1201	1291	1345	1375	1404	1431	1460	1488	1517	1544
N12JRE	1311	1401	1455	1485	1514	1541	1570	1598	1627	1654
N12JRES	1405	1495	1549	1579	1608	1635	1664	1692	1721	1748
N12JRS	1295	1385	1439	1469	1498	1525	1554	1582	1611	1638
N12JRY	1322	1412	1466	1496	1525	1552	1581	1609	1638	1665
N12JRYE	1432	1522	1576	1606	1635	1662	1691	1719	1748	1775
N12KKC	1394	1507	1574	1612	1648	1682	1718	1753	1789	1823
N12KKCE	1504	1617	1684	1722	1758	1792	1828	1863	1899	1933
N12KKCES	1603	1716	1783	1821	1857	1891	1927	1962	1998	2032
N12KKCS	1491	1604	1671	1709	1745	1779	1815	1850	1886	1920
N12KKY	1514	1627	1694	1732	1768	1802	1838	1873	1909	1943
N12KKYE	1624	1737	1804	1842	1878	1912	1948	1983	2019	2053
N12KR	1310	1423	1490	1528	1564	1598	1634	1669	1705	1739
N12KRE	1420	1533	1600	1638	1674	1708	1744	1779	1815	1849
N12KRES	1518	1631	1698	1736	1772	1806	1842	1877	1913	1947
N12KRS	1408	1521	1588	1626	1662	1696	1732	1767	1803	1837
N12KRY	1432	1545	1612	1650	1686	1720	1756	1791	1827	1861
N12KRYE	1542	1655	1722	1760	1796	1830	1866	1901	1937	1971
N12MMC	1337	1435	1493	1526	1557	1587	1618	1648	1679	1709
N12MMCE	1448	1546	1604	1637	1668	1698	1729	1759	1790	1820
N12MMCES	1543	1641	1699	1732	1763	1793	1824	1854	1885	1915
N12MMCS	1433	1531	1589	1622	1653	1683	1714	1744	1775	1805
N12MR	1254	1352	1410	1443	1474	1504	1535	1565	1596	1626
N12MRE	1364	1462	1520	1553	1584	1614	1645	1675	1706	1736
N12MRES	1461	1559	1617	1650	1681	1711	1742	1772	1803	1833
N12MRS	1351	1449	1507	1540	1571	1601	1632	1662	1693	1723
N12PPC	1448	1568	1640	1680	1718	1755	1794	1830	1869	1906
N12PPCE	1560	1680	1752	1792	1830	1867	1906	1942	1981	2018
N12PPCES	1654	1774	1846	1886	1924	1961	2000	2036	2075	2112
N12PPCS	1544	1664	1736	1776	1814	1851	1890	1926	1965	2002
N12PR	1365	1485	1557	1597	1635	1672	1711	1747	1786	1823
N12PRE	1475	1595	1667	1707	1745	1782	1821	1857	1896	1933
N12PRES	1572	1692	1764	1804	1842	1879	1918	1954	1993	2030
N12PRS	1462	1582	1654	1694	1732	1769	1808	1844	1883	1920
N12QQ	1006	1111	1174	1209	1243	1275	1308	1341	1374	1406
N12RR	895	978	1027	1055	1081	1106	1133	1158	1184	1210
N13CCC	1357	1447	1501	1531	1560	1587	1616	1644	1673	1700
N13CCCS	1453	1543	1597	1627	1656	1683	1712	1740	1769	1796
N13CCY	1477	1567	1621	1651	1680	1707	1736	1764	1793	1820

Alliance Program Pricing

Finishes

IM	Brighton	CW	Cordovan
NM	Natural	DW	Judicial
HN	Honey	MH	Mocha
CL	Caramel	405	Designer White
TF	Truffle	462	Cinder
AC	Autumn	792	Sable
MC	Amber	793	Acorn

To order, specify the following:

1. Chair Model Number
2. Fabric Grade Letter
3. Alliance Pattern Number and Color Number/Name
4. Finish Number (when applicable)

Sample Order Number

<u>N14KK</u>	<u>A</u>	<u>403901</u>	<u>036</u>	<u>HN</u>
Model Number	Fabric Grade Letter	Alliance Pattern Number	Alliance Color Number	Finish

Model Number

Alliance Program Price Grades

	A	B	C	D	E	F	G	H	I	J
N13CR	\$ 996	\$ 1023	\$ 1047	\$ 1071	\$ 1096	\$ 1125	\$ 1146	\$ 1173	\$ 1203	\$ 1230
N13CRS	1090	1117	1141	1165	1190	1219	1240	1267	1297	1324
N13CRY	1118	1145	1169	1193	1218	1247	1268	1295	1325	1352
N13DDC	1122	1157	1187	1217	1248	1284	1310	1344	1382	1415
N13DDCS	1215	1250	1280	1310	1341	1377	1403	1437	1475	1508
N13DDY	1242	1277	1307	1337	1368	1404	1430	1464	1502	1535
N13DR	1038	1073	1103	1133	1164	1200	1226	1260	1298	1331
N13DRS	1133	1168	1198	1228	1259	1295	1321	1355	1393	1426
N13DRY	1160	1195	1225	1255	1286	1322	1348	1382	1420	1453
N13EEC	1112	1142	1168	1194	1222	1253	1275	1305	1337	1366
N13EECS	1204	1234	1260	1286	1314	1345	1367	1397	1429	1458
N13ER	1028	1058	1084	1110	1138	1169	1191	1221	1253	1282
N13ERS	1123	1153	1179	1205	1233	1264	1286	1316	1348	1377
N13HHC	1155	1192	1224	1256	1289	1328	1355	1392	1432	1467
N13HHCS	1248	1285	1317	1349	1382	1421	1448	1485	1525	1560
N13HR	1070	1107	1139	1171	1204	1243	1270	1307	1347	1382
N13HRS	1166	1203	1235	1267	1300	1339	1366	1403	1443	1478
N13JJC	1101	1128	1152	1176	1201	1230	1251	1278	1308	1335
N13JJCS	1195	1222	1246	1270	1295	1324	1345	1372	1402	1429
N13JJY	1223	1250	1274	1298	1323	1352	1373	1400	1430	1457
N13JR	1018	1045	1069	1093	1118	1147	1168	1195	1225	1252
N13JRS	1114	1141	1165	1189	1214	1243	1264	1291	1321	1348
N13JRY	1141	1168	1192	1216	1241	1270	1291	1318	1348	1375
N13KKC	1143	1178	1208	1238	1269	1305	1331	1365	1403	1436
N13KKCS	1239	1274	1304	1334	1365	1401	1427	1461	1499	1532
N13KKY	1265	1300	1330	1360	1391	1427	1453	1487	1525	1558
N13KR	1060	1095	1125	1155	1186	1222	1248	1282	1320	1353
N13KRS	1157	1192	1222	1252	1283	1319	1345	1379	1417	1450
N13KRY	1182	1217	1247	1277	1308	1344	1370	1404	1442	1475
N13MMC	1131	1161	1187	1213	1241	1272	1294	1324	1356	1385
N13MMCS	1225	1255	1281	1307	1335	1366	1388	1418	1450	1479
N13MR	1049	1079	1105	1131	1159	1190	1212	1242	1274	1303
N13MRS	1143	1173	1199	1225	1253	1284	1306	1336	1368	1397
N13PPC	1174	1211	1243	1275	1308	1347	1374	1411	1451	1486
N13PPCS	1272	1309	1341	1373	1406	1445	1472	1509	1549	1584
N13PR	1092	1129	1161	1193	1226	1265	1292	1329	1369	1404
N13PRS	1190	1227	1259	1291	1324	1363	1390	1427	1467	1502
N14AAC	909	936	960	984	1009	1038	1059	1086	1116	1143
N14AACS	1007	1034	1058	1082	1107	1136	1157	1184	1214	1241
N14AAY	1031	1058	1082	1106	1131	1160	1181	1208	1238	1265
N14AR	827	854	878	902	927	956	977	1004	1034	1061
N14ARS	924	951	975	999	1024	1053	1074	1101	1131	1158
N14ARY	948	975	999	1023	1048	1077	1098	1125	1155	1182
N14BBC	953	988	1018	1048	1079	1115	1141	1175	1213	1246
N14BBCS	1046	1081	1111	1141	1172	1208	1234	1268	1306	1339
N14BBY	1075	1110	1140	1170	1201	1237	1263	1297	1335	1368
N14BR	870	905	935	965	996	1032	1058	1092	1130	1163

Model Number	Alliance Program Price Grades									
	K	L	M	N	O	P	Q	R	S	T
N13CR	\$ 1274	\$ 1364	\$ 1418	\$ 1448	\$ 1477	\$ 1504	\$ 1533	\$ 1561	\$ 1590	\$ 1617
N13CRS	1368	1458	1512	1542	1571	1598	1627	1655	1684	1711
N13CRY	1396	1486	1540	1570	1599	1626	1655	1683	1712	1739
N13DDC	1470	1583	1650	1688	1724	1758	1794	1829	1865	1899
N13DDCS	1563	1676	1743	1781	1817	1851	1887	1922	1958	1992
N13DDY	1590	1703	1770	1808	1844	1878	1914	1949	1985	2019
N13DR	1386	1499	1566	1604	1640	1674	1710	1745	1781	1815
N13DRS	1481	1594	1661	1699	1735	1769	1805	1840	1876	1910
N13DRY	1508	1621	1688	1726	1762	1796	1832	1867	1903	1937
N13EEC	1414	1512	1570	1603	1634	1664	1695	1725	1756	1786
N13EECS	1506	1604	1662	1695	1726	1756	1787	1817	1848	1878
N13ER	1330	1428	1486	1519	1550	1580	1611	1641	1672	1702
N13ERS	1425	1523	1581	1614	1645	1675	1706	1736	1767	1797
N13HHC	1526	1646	1718	1758	1796	1833	1872	1908	1947	1984
N13HHCS	1619	1739	1811	1851	1889	1926	1965	2001	2040	2077
N13HR	1441	1561	1633	1673	1711	1748	1787	1823	1862	1899
N13HRS	1537	1657	1729	1769	1807	1844	1883	1919	1958	1995
N13JJC	1379	1469	1523	1553	1582	1609	1638	1666	1695	1722
N13JJCS	1473	1563	1617	1647	1676	1703	1732	1760	1789	1816
N13JJY	1501	1591	1645	1675	1704	1731	1760	1788	1817	1844
N13JR	1296	1386	1440	1470	1499	1526	1555	1583	1612	1639
N13JRS	1392	1482	1536	1566	1595	1622	1651	1679	1708	1735
N13JRY	1419	1509	1563	1593	1622	1649	1678	1706	1735	1762
N13KKC	1491	1604	1671	1709	1745	1779	1815	1850	1886	1920
N13KKCS	1587	1700	1767	1805	1841	1875	1911	1946	1982	2016
N13KKY	1613	1726	1793	1831	1867	1901	1937	1972	2008	2042
N13KR	1408	1521	1588	1626	1662	1696	1732	1767	1803	1837
N13KRS	1505	1618	1685	1723	1759	1793	1829	1864	1900	1934
N13KRY	1530	1643	1710	1748	1784	1818	1854	1889	1925	1959
N13MMC	1433	1531	1589	1622	1653	1683	1714	1744	1775	1805
N13MMCS	1527	1625	1683	1716	1747	1777	1808	1838	1869	1899
N13MR	1351	1449	1507	1540	1571	1601	1632	1662	1693	1723
N13MRS	1445	1543	1601	1634	1665	1695	1726	1756	1787	1817
N13PPC	1545	1665	1737	1777	1815	1852	1891	1927	1966	2003
N13PPCS	1643	1763	1835	1875	1913	1950	1989	2025	2064	2101
N13PR	1463	1583	1655	1695	1733	1770	1809	1845	1884	1921
N13PRS	1561	1681	1753	1793	1831	1868	1907	1943	1982	2019
N14AAC	1187	1277	1331	1361	1390	1417	1446	1474	1503	1530
N14AACS	1285	1375	1429	1459	1488	1515	1544	1572	1601	1628
N14AAY	1309	1399	1453	1483	1512	1539	1568	1596	1625	1652
N14AR	1105	1195	1249	1279	1308	1335	1364	1392	1421	1448
N14ARS	1202	1292	1346	1376	1405	1432	1461	1489	1518	1545
N14ARY	1226	1316	1370	1400	1429	1456	1485	1513	1542	1569
N14BBC	1301	1414	1481	1519	1555	1589	1625	1660	1696	1730
N14BBCS	1394	1507	1574	1612	1648	1682	1718	1753	1789	1823
N14BBY	1423	1536	1603	1641	1677	1711	1747	1782	1818	1852
N14BR	1218	1331	1398	1436	1472	1506	1542	1577	1613	1647

Alliance Program Pricing

Finishes

IM	Brighton	CW	Cordovan
NM	Natural	DW	Judicial
HN	Honey	MH	Mocha
CL	Caramel	405	Designer White
TF	Truffle	462	Cinder
AC	Autumn	792	Sable
MC	Amber	793	Acorn

To order, specify the following:

1. Chair Model Number
2. Fabric Grade Letter
3. Alliance Pattern Number and Color Number/Name
4. Finish Number (when applicable)

Sample Order Number

<u>N14KK</u>	<u>A</u>	<u>403901</u>	<u>036</u>	<u>HN</u>
Model Number	Fabric Grade Letter	Alliance Pattern Number	Alliance Color Number	Finish

Model Number

Alliance Program Price Grades

	A	B	C	D	E	F	G	H	I	J
N14BRS	\$ 962	\$ 997	\$ 1027	\$ 1057	\$ 1088	\$ 1124	\$ 1150	\$ 1184	\$ 1222	\$ 1255
N14BRY	991	1026	1056	1086	1117	1153	1179	1213	1251	1284
N14CCC	1159	1186	1210	1234	1259	1288	1309	1336	1366	1393
N14CCCS	1257	1284	1308	1332	1357	1386	1407	1434	1464	1491
N14CCY	1282	1309	1333	1357	1382	1411	1432	1459	1489	1516
N14CR	1077	1104	1128	1152	1177	1206	1227	1254	1284	1311
N14CRS	1175	1202	1226	1250	1275	1304	1325	1352	1382	1409
N14CRY	1197	1224	1248	1272	1297	1326	1347	1374	1404	1431
N14DDC	1202	1237	1267	1297	1328	1364	1390	1424	1462	1495
N14DDCS	1298	1333	1363	1393	1424	1460	1486	1520	1558	1591
N14DDY	1324	1359	1389	1419	1450	1486	1512	1546	1584	1617
N14DR	1121	1156	1186	1216	1247	1283	1309	1343	1381	1414
N14DRS	1213	1248	1278	1308	1339	1375	1401	1435	1473	1506
N14DRY	1241	1276	1306	1336	1367	1403	1429	1463	1501	1534
N14EEC	1192	1222	1248	1274	1302	1333	1355	1385	1417	1446
N14EECS	1287	1317	1343	1369	1397	1428	1450	1480	1512	1541
N14ER	1111	1141	1167	1193	1221	1252	1274	1304	1336	1365
N14ERS	1202	1232	1258	1284	1312	1343	1365	1395	1427	1456
N14HHC	1234	1271	1303	1335	1368	1407	1434	1471	1511	1546
N14HHCS	1332	1369	1401	1433	1466	1505	1532	1569	1609	1644
N14HR	1151	1188	1220	1252	1285	1324	1351	1388	1428	1463
N14HRS	1247	1284	1316	1348	1381	1420	1447	1484	1524	1559
N14JJC	1184	1211	1235	1259	1284	1313	1334	1361	1391	1418
N14JJCS	1280	1307	1331	1355	1380	1409	1430	1457	1487	1514
N14JJY	1304	1331	1355	1379	1404	1433	1454	1481	1511	1538
N14JR	1101	1128	1152	1176	1201	1230	1251	1278	1308	1335
N14JRS	1195	1222	1246	1270	1295	1324	1345	1372	1402	1429
N14JRY	1223	1250	1274	1298	1323	1352	1373	1400	1430	1457
N14KKC	1226	1261	1291	1321	1352	1388	1414	1448	1486	1519
N14KKCS	1318	1353	1383	1413	1444	1480	1506	1540	1578	1611
N14KKY	1346	1381	1411	1441	1472	1508	1534	1568	1606	1639
N14KR	1141	1176	1206	1236	1267	1303	1329	1363	1401	1434
N14KRS	1237	1272	1302	1332	1363	1399	1425	1459	1497	1530
N14KRY	1264	1299	1329	1359	1390	1426	1452	1486	1524	1557
N14MMC	1216	1246	1272	1298	1326	1357	1379	1409	1441	1470
N14MMCS	1308	1338	1364	1390	1418	1449	1471	1501	1533	1562
N14MR	1131	1161	1187	1213	1241	1272	1294	1324	1356	1385
N14MRS	1227	1257	1283	1309	1337	1368	1390	1420	1452	1481
N14PPC	1260	1297	1329	1361	1394	1433	1460	1497	1537	1572
N14PPCS	1353	1390	1422	1454	1487	1526	1553	1590	1630	1665
N14PR	1175	1212	1244	1276	1309	1348	1375	1412	1452	1487
N14PRS	1271	1308	1340	1372	1405	1444	1471	1508	1548	1583
N14QQ	752	784	812	840	870	903	927	959	994	1025
N14RR	710	735	757	779	802	829	847	873	900	924
N15AAY	829	850	868	886	905	926	942	962	985	1005
N15ARY	746	767	785	803	822	843	859	879	902	922
N15CCY	984	1005	1023	1041	1060	1081	1097	1117	1140	1160

Model Number	Alliance Program Price Grades									
	K	L	M	N	O	P	Q	R	S	T
N14BRS	\$ 1310	\$ 1423	\$ 1490	\$ 1528	\$ 1564	\$ 1598	\$ 1634	\$ 1669	\$ 1705	\$ 1739
N14BRY	1339	1452	1519	1557	1593	1627	1663	1698	1734	1768
N14CCC	1437	1527	1581	1611	1640	1667	1696	1724	1753	1780
N14CCCS	1535	1625	1679	1709	1738	1765	1794	1822	1851	1878
N14CCY	1560	1650	1704	1734	1763	1790	1819	1847	1876	1903
N14CR	1355	1445	1499	1529	1558	1585	1614	1642	1671	1698
N14CRS	1453	1543	1597	1627	1656	1683	1712	1740	1769	1796
N14CRY	1475	1565	1619	1649	1678	1705	1734	1762	1791	1818
N14DDC	1550	1663	1730	1768	1804	1838	1874	1909	1945	1979
N14DDCS	1646	1759	1826	1864	1900	1934	1970	2005	2041	2075
N14DDY	1672	1785	1852	1890	1926	1960	1996	2031	2067	2101
N14DR	1469	1582	1649	1687	1723	1757	1793	1828	1864	1898
N14DRS	1561	1674	1741	1779	1815	1849	1885	1920	1956	1990
N14DRY	1589	1702	1769	1807	1843	1877	1913	1948	1984	2018
N14EEC	1494	1592	1650	1683	1714	1744	1775	1805	1836	1866
N14EECS	1589	1687	1745	1778	1809	1839	1870	1900	1931	1961
N14ER	1413	1511	1569	1602	1633	1663	1694	1724	1755	1785
N14ERS	1504	1602	1660	1693	1724	1754	1785	1815	1846	1876
N14HHC	1605	1725	1797	1837	1875	1912	1951	1987	2026	2063
N14HHCS	1703	1823	1895	1935	1973	2010	2049	2085	2124	2161
N14HR	1522	1642	1714	1754	1792	1829	1868	1904	1943	1980
N14HRS	1618	1738	1810	1850	1888	1925	1964	2000	2039	2076
N14JJC	1462	1552	1606	1636	1665	1692	1721	1749	1778	1805
N14JJCS	1558	1648	1702	1732	1761	1788	1817	1845	1874	1901
N14JJY	1582	1672	1726	1756	1785	1812	1841	1869	1898	1925
N14JR	1379	1469	1523	1553	1582	1609	1638	1666	1695	1722
N14JRS	1473	1563	1617	1647	1676	1703	1732	1760	1789	1816
N14JRY	1501	1591	1645	1675	1704	1731	1760	1788	1817	1844
N14KKC	1574	1687	1754	1792	1828	1862	1898	1933	1969	2003
N14KKCS	1666	1779	1846	1884	1920	1954	1990	2025	2061	2095
N14KKY	1694	1807	1874	1912	1948	1982	2018	2053	2089	2123
N14KR	1489	1602	1669	1707	1743	1777	1813	1848	1884	1918
N14KRS	1585	1698	1765	1803	1839	1873	1909	1944	1980	2014
N14KRY	1612	1725	1792	1830	1866	1900	1936	1971	2007	2041
N14MMC	1518	1616	1674	1707	1738	1768	1799	1829	1860	1890
N14MMCS	1610	1708	1766	1799	1830	1860	1891	1921	1952	1982
N14MR	1433	1531	1589	1622	1653	1683	1714	1744	1775	1805
N14MRS	1529	1627	1685	1718	1749	1779	1810	1840	1871	1901
N14PPC	1631	1751	1823	1863	1901	1938	1977	2013	2052	2089
N14PPCS	1724	1844	1916	1956	1994	2031	2070	2106	2145	2182
N14PR	1546	1666	1738	1778	1816	1853	1892	1928	1967	2004
N14PRS	1642	1762	1834	1874	1912	1949	1988	2024	2063	2100
N14QQ	1077	1182	1245	1280	1314	1346	1379	1412	1445	1477
N14RR	965	1048	1097	1125	1151	1176	1203	1228	1254	1280
N15AAY	1038	1106	1146	1169	1190	1211	1232	1253	1275	1295
N15ARY	955	1023	1063	1086	1107	1128	1149	1170	1192	1212
N15CCY	1193	1261	1301	1324	1345	1366	1387	1408	1430	1450

Alliance Program Pricing

Finishes

IM	Brighton	CW	Cordovan
NM	Natural	DW	Judicial
HN	Honey	MH	Mocha
CL	Caramel	405	Designer White
TF	Truffle	462	Cinder
AC	Autumn	792	Sable
MC	Amber	793	Acorn

To order, specify the following:

1. Chair Model Number
2. Fabric Grade Letter
3. Alliance Pattern Number and Color Number/Name
4. Finish Number (when applicable)

Sample Order Number

<u>N14KK</u>	<u>A</u>	<u>403901</u>	<u>036</u>	<u>HN</u>
Model Number	Fabric Grade Letter	Alliance Pattern Number	Alliance Color Number	Finish

Model Number

Alliance Program Price Grades

	A	B	C	D	E	F	G	H	I	J
N15CRY	\$ 902	\$ 923	\$ 941	\$ 959	\$ 978	\$ 999	\$ 1015	\$ 1035	\$ 1058	\$ 1078
N15EE	891	912	930	948	967	988	1004	1024	1047	1067
N15EES	986	1007	1025	1043	1062	1083	1099	1119	1142	1162
N15ER	809	830	848	866	885	906	922	942	965	985
N15ERS	904	925	943	961	980	1001	1017	1037	1060	1080
N15GG	736	757	775	793	812	833	849	869	892	912
N15GGS	831	852	870	888	907	928	944	964	987	1007
N15GR	653	674	692	710	729	750	766	786	809	829
N15GRS	748	769	787	805	824	845	861	881	904	924
N15HH	1002	1023	1041	1059	1078	1099	1115	1135	1158	1178
N15HHS	1098	1119	1137	1155	1174	1195	1211	1231	1254	1274
N15HR	920	941	959	977	996	1017	1033	1053	1076	1096
N15HRS	1014	1035	1053	1071	1090	1111	1127	1147	1170	1190
N15JJY	1004	1025	1043	1061	1080	1101	1117	1137	1160	1180
N15JJYE	1114	1135	1153	1171	1190	1211	1227	1247	1270	1290
N15JRY	922	943	961	979	998	1019	1035	1055	1078	1098
N15JRYE	1032	1053	1071	1089	1108	1129	1145	1165	1188	1208
N15LL	846	867	885	903	922	943	959	979	1002	1022
N15LLS	941	962	980	998	1017	1038	1054	1074	1097	1117
N15LR	763	784	802	820	839	860	876	896	919	939
N15LRS	858	879	897	915	934	955	971	991	1014	1034
N15MM	910	931	949	967	986	1007	1023	1043	1066	1086
N15MME	1020	1041	1059	1077	1096	1117	1133	1153	1176	1196
N15MMES	1116	1137	1155	1173	1192	1213	1229	1249	1272	1292
N15MMS	1006	1027	1045	1063	1082	1103	1119	1139	1162	1182
N15MR	827	848	866	884	903	924	940	960	983	1003
N15MRE	937	958	976	994	1013	1034	1050	1070	1093	1113
N15MRES	1034	1055	1073	1091	1110	1131	1147	1167	1190	1210
N15MRS	924	945	963	981	1000	1021	1037	1057	1080	1100
N15PP	1020	1041	1059	1077	1096	1117	1133	1153	1176	1196
N15PPE	1131	1152	1170	1188	1207	1228	1244	1264	1287	1307
N15PPES	1226	1247	1265	1283	1302	1323	1339	1359	1382	1402
N15PPS	1116	1137	1155	1173	1192	1213	1229	1249	1272	1292
N15PR	937	958	976	994	1013	1034	1050	1070	1093	1113
N15PRE	1047	1068	1086	1104	1123	1144	1160	1180	1203	1223
N15PRES	1144	1165	1183	1201	1220	1241	1257	1277	1300	1320
N15PRS	1034	1055	1073	1091	1110	1131	1147	1167	1190	1210
N15RR	662	683	701	719	738	759	775	795	818	838
N16CCY	1077	1098	1116	1134	1153	1174	1190	1210	1233	1253
N16CRY	996	1017	1035	1053	1072	1093	1109	1129	1152	1172
N16EE	985	1006	1024	1042	1061	1082	1098	1118	1141	1161
N16EES	1079	1100	1118	1136	1155	1176	1192	1212	1235	1255
N16ER	903	924	942	960	979	1000	1016	1036	1059	1079
N16ERS	998	1019	1037	1055	1074	1095	1111	1131	1154	1174
N16HH	1097	1118	1136	1154	1173	1194	1210	1230	1253	1273
N16HHS	1189	1210	1228	1246	1265	1286	1302	1322	1345	1365
N16HR	1013	1034	1052	1070	1089	1110	1126	1146	1169	1189

Model Number

Alliance Program Price Grades

	K	L	M	N	O	P	Q	R	S	T
N15CRY	\$ 1111	\$ 1179	\$ 1219	\$ 1242	\$ 1263	\$ 1284	\$ 1305	\$ 1326	\$ 1348	\$ 1368
N15EE	1100	1168	1208	1231	1252	1273	1294	1315	1337	1357
N15EES	1195	1263	1303	1326	1347	1368	1389	1410	1432	1452
N15ER	1018	1086	1126	1149	1170	1191	1212	1233	1255	1275
N15ERS	1113	1181	1221	1244	1265	1286	1307	1328	1350	1370
N15GG	945	1013	1053	1076	1097	1118	1139	1160	1182	1202
N15GGS	1040	1108	1148	1171	1192	1213	1234	1255	1277	1297
N15GR	862	930	970	993	1014	1035	1056	1077	1099	1119
N15GRS	957	1025	1065	1088	1109	1130	1151	1172	1194	1214
N15HH	1211	1279	1319	1342	1363	1384	1405	1426	1448	1468
N15HHS	1307	1375	1415	1438	1459	1480	1501	1522	1544	1564
N15HR	1129	1197	1237	1260	1281	1302	1323	1344	1366	1386
N15HRS	1223	1291	1331	1354	1375	1396	1417	1438	1460	1480
N15JJY	1213	1281	1321	1344	1365	1386	1407	1428	1450	1470
N15JJYE	1323	1391	1431	1454	1475	1496	1517	1538	1560	1580
N15JRY	1131	1199	1239	1262	1283	1304	1325	1346	1368	1388
N15JRYE	1241	1309	1349	1372	1393	1414	1435	1456	1478	1498
N15LL	1055	1123	1163	1186	1207	1228	1249	1270	1292	1312
N15LLS	1150	1218	1258	1281	1302	1323	1344	1365	1387	1407
N15LR	972	1040	1080	1103	1124	1145	1166	1187	1209	1229
N15LRS	1067	1135	1175	1198	1219	1240	1261	1282	1304	1324
N15MM	1119	1187	1227	1250	1271	1292	1313	1334	1356	1376
N15MME	1229	1297	1337	1360	1381	1402	1423	1444	1466	1486
N15MMES	1325	1393	1433	1456	1477	1498	1519	1540	1562	1582
N15MMS	1215	1283	1323	1346	1367	1388	1409	1430	1452	1472
N15MR	1036	1104	1144	1167	1188	1209	1230	1251	1273	1293
N15MRE	1146	1214	1254	1277	1298	1319	1340	1361	1383	1403
N15MRES	1243	1311	1351	1374	1395	1416	1437	1458	1480	1500
N15MRS	1133	1201	1241	1264	1285	1306	1327	1348	1370	1390
N15PP	1229	1297	1337	1360	1381	1402	1423	1444	1466	1486
N15PPE	1340	1408	1448	1471	1492	1513	1534	1555	1577	1597
N15PPES	1435	1503	1543	1566	1587	1608	1629	1650	1672	1692
N15PPS	1325	1393	1433	1456	1477	1498	1519	1540	1562	1582
N15PR	1146	1214	1254	1277	1298	1319	1340	1361	1383	1403
N15PRE	1256	1324	1364	1387	1408	1429	1450	1471	1493	1513
N15PRES	1353	1421	1461	1484	1505	1526	1547	1568	1590	1610
N15PRS	1243	1311	1351	1374	1395	1416	1437	1458	1480	1500
N15RR	871	939	979	1002	1023	1044	1065	1086	1108	1128
N16CCY	1286	1354	1394	1417	1438	1459	1480	1501	1523	1543
N16CRY	1205	1273	1313	1336	1357	1378	1399	1420	1442	1462
N16EE	1194	1262	1302	1325	1346	1367	1388	1409	1431	1451
N16EES	1288	1356	1396	1419	1440	1461	1482	1503	1525	1545
N16ER	1112	1180	1220	1243	1264	1285	1306	1327	1349	1369
N16ERS	1207	1275	1315	1338	1359	1380	1401	1422	1444	1464
N16HH	1306	1374	1414	1437	1458	1479	1500	1521	1543	1563
N16HHS	1398	1466	1506	1529	1550	1571	1592	1613	1635	1655
N16HR	1222	1290	1330	1353	1374	1395	1416	1437	1459	1479

Alliance Program Pricing

Finishes

IM	Brighton	CW	Cordovan
NM	Natural	DW	Judicial
HN	Honey	MH	Mocha
CL	Caramel	405	Designer White
TF	Truffle	462	Cinder
AC	Autumn	792	Sable
MC	Amber	793	Acorn

To order, specify the following:

1. Chair Model Number
2. Fabric Grade Letter
3. Alliance Pattern Number and Color Number/Name
4. Finish Number (when applicable)

Sample Order Number

<u>N14KK</u>	<u>A</u>	<u>403901</u>	<u>036</u>	<u>HN</u>
Model Number	Fabric Grade Letter	Alliance Pattern Number	Alliance Color Number	Finish

Model Number

Alliance Program Price Grades

	A	B	C	D	E	F	G	H	I	J
N16HRS	\$ 1108	\$ 1129	\$ 1147	\$ 1165	\$ 1184	\$ 1205	\$ 1221	\$ 1241	\$ 1264	\$ 1284
N16JJY	1101	1122	1140	1158	1177	1198	1214	1234	1257	1277
N16JRY	1018	1039	1057	1075	1094	1115	1131	1151	1174	1194
N16MM	1006	1027	1045	1063	1082	1103	1119	1139	1162	1182
N16MMS	1100	1121	1139	1157	1176	1197	1213	1233	1256	1276
N16MR	924	945	963	981	1000	1021	1037	1057	1080	1100
N16MRS	1017	1038	1056	1074	1093	1114	1130	1150	1173	1193
N16PP	1116	1137	1155	1173	1192	1213	1229	1249	1272	1292
N16PPS	1210	1231	1249	1267	1286	1307	1323	1343	1366	1386
N16PR	1034	1055	1073	1091	1110	1131	1147	1167	1190	1210
N16PRS	1128	1149	1167	1185	1204	1225	1241	1261	1284	1304
N17AAY	908	929	947	965	984	1005	1021	1041	1064	1084
N17ARY	826	847	865	883	902	923	939	959	982	1002
N17CCY	1159	1180	1198	1216	1235	1256	1272	1292	1315	1335
N17CRY	1075	1096	1114	1132	1151	1172	1188	1208	1231	1251
N17EE	1067	1088	1106	1124	1143	1164	1180	1200	1223	1243
N17EES	1272	1293	1311	1329	1348	1369	1385	1405	1428	1448
N17ER	984	1005	1023	1041	1060	1081	1097	1117	1140	1160
N17ERS	1187	1208	1226	1244	1263	1284	1300	1320	1343	1363
N17GG	817	838	856	874	893	914	930	950	973	993
N17GGS	911	932	950	968	987	1008	1024	1044	1067	1087
N17GR	734	755	773	791	810	831	847	867	890	910
N17GRS	828	849	867	885	904	925	941	961	984	1004
N17HH	1177	1198	1216	1234	1253	1274	1290	1310	1333	1353
N17HHS	1382	1403	1421	1439	1458	1479	1495	1515	1538	1558
N17HR	1096	1117	1135	1153	1172	1193	1209	1229	1252	1272
N17HRS	1298	1319	1337	1355	1374	1395	1411	1431	1454	1474
N17JJY	1182	1203	1221	1239	1258	1279	1295	1315	1338	1358
N17JRY	1101	1122	1140	1158	1177	1198	1214	1234	1257	1277
N17LL	927	948	966	984	1003	1024	1040	1060	1083	1103
N17LLS	1021	1042	1060	1078	1097	1118	1134	1154	1177	1197
N17LR	844	865	883	901	920	941	957	977	1000	1020
N17LRS	938	959	977	995	1014	1035	1051	1071	1094	1114
N17MM	1089	1110	1128	1146	1165	1186	1202	1222	1245	1265
N17MMS	1183	1204	1222	1240	1259	1280	1296	1316	1339	1359
N17MR	1006	1027	1045	1063	1082	1103	1119	1139	1162	1182
N17MRS	1102	1123	1141	1159	1178	1199	1215	1235	1258	1278
N17PP	1201	1222	1240	1258	1277	1298	1314	1334	1357	1377
N17PPS	1293	1314	1332	1350	1369	1390	1406	1426	1449	1469
N17PR	1116	1137	1155	1173	1192	1213	1229	1249	1272	1292
N17PRS	1212	1233	1251	1269	1288	1309	1325	1345	1368	1388
N17RR	733	754	772	790	809	830	846	866	889	909
N21AATUC	833	849	863	877	891	908	920	936	954	969
N21AATUG	833	849	863	877	891	908	920	936	954	969
N21AAUC	654	670	684	698	712	729	741	757	775	790
N21AAUG	654	670	684	698	712	729	741	757	775	790
N21BBTUC	731	747	761	775	789	806	818	834	852	867

Model Number	Alliance Program Price Grades									
	K	L	M	N	O	P	Q	R	S	T
N16HRS	\$ 1317	\$ 1385	\$ 1425	\$ 1448	\$ 1469	\$ 1490	\$ 1511	\$ 1532	\$ 1554	\$ 1574
N16JJY	1310	1378	1418	1441	1462	1483	1504	1525	1547	1567
N16JRY	1227	1295	1335	1358	1379	1400	1421	1442	1464	1484
N16MM	1215	1283	1323	1346	1367	1388	1409	1430	1452	1472
N16MMS	1309	1377	1417	1440	1461	1482	1503	1524	1546	1566
N16MR	1133	1201	1241	1264	1285	1306	1327	1348	1370	1390
N16MRS	1226	1294	1334	1357	1378	1399	1420	1441	1463	1483
N16PP	1325	1393	1433	1456	1477	1498	1519	1540	1562	1582
N16PPS	1419	1487	1527	1550	1571	1592	1613	1634	1656	1676
N16PR	1243	1311	1351	1374	1395	1416	1437	1458	1480	1500
N16PRS	1337	1405	1445	1468	1489	1510	1531	1552	1574	1594
N17AAY	1117	1185	1225	1248	1269	1290	1311	1332	1354	1374
N17ARY	1035	1103	1143	1166	1187	1208	1229	1250	1272	1292
N17CCY	1368	1436	1476	1499	1520	1541	1562	1583	1605	1625
N17CRY	1284	1352	1392	1415	1436	1457	1478	1499	1521	1541
N17EE	1276	1344	1384	1407	1428	1449	1470	1491	1513	1533
N17EES	1481	1549	1589	1612	1633	1654	1675	1696	1718	1738
N17ER	1193	1261	1301	1324	1345	1366	1387	1408	1430	1450
N17ERS	1396	1464	1504	1527	1548	1569	1590	1611	1633	1653
N17GG	1026	1094	1134	1157	1178	1199	1220	1241	1263	1283
N17GGS	1120	1188	1228	1251	1272	1293	1314	1335	1357	1377
N17GR	943	1011	1051	1074	1095	1116	1137	1158	1180	1200
N17GRS	1037	1105	1145	1168	1189	1210	1231	1252	1274	1294
N17HH	1386	1454	1494	1517	1538	1559	1580	1601	1623	1643
N17HHS	1591	1659	1699	1722	1743	1764	1785	1806	1828	1848
N17HR	1305	1373	1413	1436	1457	1478	1499	1520	1542	1562
N17HRS	1507	1575	1615	1638	1659	1680	1701	1722	1744	1764
N17JJY	1391	1459	1499	1522	1543	1564	1585	1606	1628	1648
N17JRY	1310	1378	1418	1441	1462	1483	1504	1525	1547	1567
N17LL	1136	1204	1244	1267	1288	1309	1330	1351	1373	1393
N17LLS	1230	1298	1338	1361	1382	1403	1424	1445	1467	1487
N17LR	1053	1121	1161	1184	1205	1226	1247	1268	1290	1310
N17LRS	1147	1215	1255	1278	1299	1320	1341	1362	1384	1404
N17MM	1298	1366	1406	1429	1450	1471	1492	1513	1535	1555
N17MMS	1392	1460	1500	1523	1544	1565	1586	1607	1629	1649
N17MR	1215	1283	1323	1346	1367	1388	1409	1430	1452	1472
N17MRS	1311	1379	1419	1442	1463	1484	1505	1526	1548	1568
N17PP	1410	1478	1518	1541	1562	1583	1604	1625	1647	1667
N17PPS	1502	1570	1610	1633	1654	1675	1696	1717	1739	1759
N17PR	1325	1393	1433	1456	1477	1498	1519	1540	1562	1582
N17PRS	1421	1489	1529	1552	1573	1594	1615	1636	1658	1678
N17RR	942	1010	1050	1073	1094	1115	1136	1157	1179	1199
N21AATUC	995	1048	1079	1097	1113	1129	1146	1162	1179	1195
N21AATUG	995	1048	1079	1097	1113	1129	1146	1162	1179	1195
N21AAUC	816	869	900	918	934	950	967	983	1000	1016
N21AAUG	816	869	900	918	934	950	967	983	1000	1016
N21BBTUC	893	946	977	995	1011	1027	1044	1060	1077	1093

Alliance Program Pricing

Finishes

IM	Brighton	CW	Cordovan
NM	Natural	DW	Judicial
HN	Honey	MH	Mocha
CL	Caramel	405	Designer White
TF	Truffle	462	Cinder
AC	Autumn	792	Sable
MC	Amber	793	Acorn

To order, specify the following:

1. Chair Model Number
2. Fabric Grade Letter
3. Alliance Pattern Number and Color Number/Name
4. Finish Number (when applicable)

Sample Order Number

<u>N14KK</u>	<u>A</u>	<u>403901</u>	<u>036</u>	<u>HN</u>
Model Number	Fabric Grade Letter	Alliance Pattern Number	Alliance Color Number	Finish

Model Number

Alliance Program Price Grades

	A	B	C	D	E	F	G	H	I	J
N21BBTUG	\$ 731	\$ 747	\$ 761	\$ 775	\$ 789	\$ 806	\$ 818	\$ 834	\$ 852	\$ 867
N21BBUC	552	568	582	596	610	627	639	655	673	688
N21BBUG	552	568	582	596	610	627	639	655	673	688
N21CCUC	680	696	710	724	738	755	767	783	801	816
N21CCUG	680	696	710	724	738	755	767	783	801	816
N21UPH	180	196	210	224	238	255	267	283	301	316
N22HMA	739	760	778	796	815	836	852	872	895	915
N22HMM	678	699	717	735	754	775	791	811	834	854
N23AAC	680	701	719	737	756	777	793	813	836	856
N23AACY	842	863	881	899	918	939	955	975	998	1018
N23BBC	734	769	799	829	860	896	922	956	994	1027
N23BBCY	895	930	960	990	1021	1057	1083	1117	1155	1188
N23CCC	831	852	870	888	907	928	944	964	987	1007
N23CCCD	943	964	982	1000	1019	1040	1056	1076	1099	1119
N23CCCY	992	1013	1031	1049	1068	1089	1105	1125	1148	1168
N23CCCYD	1104	1125	1143	1161	1180	1201	1217	1237	1260	1280
N23DDC	850	873	893	913	934	958	975	998	1023	1045
N23DDCD	962	985	1005	1025	1046	1070	1087	1110	1135	1157
N23EEC	884	919	949	979	1010	1046	1072	1106	1144	1177
N23EECD	997	1032	1062	1092	1123	1159	1185	1219	1257	1290
N23EECY	1045	1080	1110	1140	1171	1207	1233	1267	1305	1338
N23EECYD	1157	1192	1222	1252	1283	1319	1345	1379	1417	1450
N23HHC	906	943	975	1007	1040	1079	1106	1143	1183	1218
N23HHCD	1018	1055	1087	1119	1152	1191	1218	1255	1295	1330
N23JJC	912	933	951	969	988	1009	1025	1045	1068	1088
N23KKC	934	957	977	997	1018	1042	1059	1082	1107	1129
N23MMC	966	1001	1031	1061	1092	1128	1154	1188	1226	1259
N23PPC	986	1023	1055	1087	1120	1159	1186	1223	1263	1298
N23RRC	790	827	859	891	924	963	990	1027	1067	1102
N23SSC	735	758	778	798	819	843	860	883	908	930
N24AAC	778	799	817	835	854	875	891	911	934	954
N24BBC	831	866	896	926	957	993	1019	1053	1091	1124
N24CCC	924	945	963	981	1000	1021	1037	1057	1080	1100
N24CCCD	1037	1058	1076	1094	1113	1134	1150	1170	1193	1213
N24DDC	947	970	990	1010	1031	1055	1072	1095	1120	1142
N24DDCD	1060	1083	1103	1123	1144	1168	1185	1208	1233	1255
N24EEC	980	1015	1045	1075	1106	1142	1168	1202	1240	1273
N24EECD	1092	1127	1157	1187	1218	1254	1280	1314	1352	1385
N24HHC	1000	1037	1069	1101	1134	1173	1200	1237	1277	1312
N24HHCD	1113	1150	1182	1214	1247	1286	1313	1350	1390	1425
N24JJC	1008	1029	1047	1065	1084	1105	1121	1141	1164	1184
N24KKC	1027	1050	1070	1090	1111	1135	1152	1175	1200	1222
N24MMC	1061	1096	1126	1156	1187	1223	1249	1283	1321	1354
N24PPC	1082	1119	1151	1183	1216	1255	1282	1319	1359	1394
N24RRC	882	919	951	983	1016	1055	1082	1119	1159	1194
N24SSC	829	852	872	892	913	937	954	977	1002	1024
N25AAC	774	795	813	831	850	871	887	907	930	950

Model Number	Alliance Program Price Grades									
	K	L	M	N	O	P	Q	R	S	T
N21BBTUG	\$ 893	\$ 946	\$ 977	\$ 995	\$ 1011	\$ 1027	\$ 1044	\$ 1060	\$ 1077	\$ 1093
N21BBUC	714	767	798	816	832	848	865	881	898	914
N21BBUG	714	767	798	816	832	848	865	881	898	914
N21CCUC	842	895	926	944	960	976	993	1009	1026	1042
N21CCUG	842	895	926	944	960	976	993	1009	1026	1042
N21UPH	342	395	426	444	460	476	493	509	526	542
N22HMA	948	1016	1056	1079	1100	1121	1142	1163	1185	1205
N22HMM	887	955	995	1018	1039	1060	1081	1102	1124	1144
N23AAC	889	957	997	1020	1041	1062	1083	1104	1126	1146
N23AACY	1051	1119	1159	1182	1203	1224	1245	1266	1288	1308
N23BBC	1082	1195	1262	1300	1336	1370	1406	1441	1477	1511
N23BBCY	1243	1356	1423	1461	1497	1531	1567	1602	1638	1672
N23CCC	1040	1108	1148	1171	1192	1213	1234	1255	1277	1297
N23CCCD	1152	1220	1260	1283	1304	1325	1346	1367	1389	1409
N23CCCY	1201	1269	1309	1332	1353	1374	1395	1416	1438	1458
N23CCCYD	1313	1381	1421	1444	1465	1486	1507	1528	1550	1570
N23DDC	1082	1157	1202	1227	1251	1274	1298	1321	1345	1368
N23DDCD	1194	1269	1314	1339	1363	1386	1410	1433	1457	1480
N23EEC	1232	1345	1412	1450	1486	1520	1556	1591	1627	1661
N23EECD	1345	1458	1525	1563	1599	1633	1669	1704	1740	1774
N23EECY	1393	1506	1573	1611	1647	1681	1717	1752	1788	1822
N23EECYD	1505	1618	1685	1723	1759	1793	1829	1864	1900	1934
N23HHC	1277	1397	1469	1509	1547	1584	1623	1659	1698	1735
N23HHCD	1389	1509	1581	1621	1659	1696	1735	1771	1810	1847
N23JJC	1121	1189	1229	1252	1273	1294	1315	1336	1358	1378
N23KKC	1166	1241	1286	1311	1335	1358	1382	1405	1429	1452
N23MMC	1314	1427	1494	1532	1568	1602	1638	1673	1709	1743
N23PPC	1357	1477	1549	1589	1627	1664	1703	1739	1778	1815
N23RRC	1161	1281	1353	1393	1431	1468	1507	1543	1582	1619
N23SSC	967	1042	1087	1112	1136	1159	1183	1206	1230	1253
N24AAC	987	1055	1095	1118	1139	1160	1181	1202	1224	1244
N24BBC	1179	1292	1359	1397	1433	1467	1503	1538	1574	1608
N24CCC	1133	1201	1241	1264	1285	1306	1327	1348	1370	1390
N24CCCD	1246	1314	1354	1377	1398	1419	1440	1461	1483	1503
N24DDC	1179	1254	1299	1324	1348	1371	1395	1418	1442	1465
N24DDCD	1292	1367	1412	1437	1461	1484	1508	1531	1555	1578
N24EEC	1328	1441	1508	1546	1582	1616	1652	1687	1723	1757
N24EECD	1440	1553	1620	1658	1694	1728	1764	1799	1835	1869
N24HHC	1371	1491	1563	1603	1641	1678	1717	1753	1792	1829
N24HHCD	1484	1604	1676	1716	1754	1791	1830	1866	1905	1942
N24JJC	1217	1285	1325	1348	1369	1390	1411	1432	1454	1474
N24KKC	1259	1334	1379	1404	1428	1451	1475	1498	1522	1545
N24MMC	1409	1522	1589	1627	1663	1697	1733	1768	1804	1838
N24PPC	1453	1573	1645	1685	1723	1760	1799	1835	1874	1911
N24RRC	1253	1373	1445	1485	1523	1560	1599	1635	1674	1711
N24SSC	1061	1136	1181	1206	1230	1253	1277	1300	1324	1347
N25AAC	983	1051	1091	1114	1135	1156	1177	1198	1220	1240

Alliance Program Pricing

Finishes

IM	Brighton	CW	Cordovan
NM	Natural	DW	Judicial
HN	Honey	MH	Mocha
CL	Caramel	405	Designer White
TF	Truffle	462	Cinder
AC	Autumn	792	Sable
MC	Amber	793	Acorn

To order, specify the following:

1. Chair Model Number
2. Fabric Grade Letter
3. Alliance Pattern Number and Color Number/Name
4. Finish Number (when applicable)

Sample Order Number

<u>N14KK</u>	<u>A</u>	<u>403901</u>	<u>036</u>	<u>HN</u>
Model Number	Fabric Grade Letter	Alliance Pattern Number	Alliance Color Number	Finish

Model Number

Alliance Program Price Grades

	A	B	C	D	E	F	G	H	I	J
N25AACY	\$ 934	\$ 955	\$ 973	\$ 991	\$ 1010	\$ 1031	\$ 1047	\$ 1067	\$ 1090	\$ 1110
N25BBC	825	860	890	920	951	987	1013	1047	1085	1118
N25BBCY	988	1023	1053	1083	1114	1150	1176	1210	1248	1281
N25CCC	922	943	961	979	998	1019	1035	1055	1078	1098
N25CCCD	1034	1055	1073	1091	1110	1131	1147	1167	1190	1210
N25CCCX	1015	1036	1054	1072	1091	1112	1128	1148	1171	1191
N25CCCXD	1127	1148	1166	1184	1203	1224	1240	1260	1283	1303
N25CCCY	1108	1143	1173	1203	1234	1270	1296	1330	1368	1401
N25CCCYD	1220	1255	1285	1315	1346	1382	1408	1442	1480	1513
N25DDC	943	966	986	1006	1027	1051	1068	1091	1116	1138
N25DDCD	1056	1079	1099	1119	1140	1164	1181	1204	1229	1251
N25DDCX	1034	1057	1077	1097	1118	1142	1159	1182	1207	1229
N25DDCXD	1146	1169	1189	1209	1230	1254	1271	1294	1319	1341
N25EEC	978	1013	1043	1073	1104	1140	1166	1200	1238	1271
N25EECD	1090	1125	1155	1185	1216	1252	1278	1312	1350	1383
N25EECY	1140	1175	1205	1235	1266	1302	1328	1362	1400	1433
N25EECYD	1252	1287	1317	1347	1378	1414	1440	1474	1512	1545
N25HHC	996	1033	1065	1097	1130	1169	1196	1233	1273	1308
N25HHCD	1110	1147	1179	1211	1244	1283	1310	1347	1387	1422
N25JJC	1004	1025	1043	1061	1080	1101	1117	1137	1160	1180
N25KKC	1024	1047	1067	1087	1108	1132	1149	1172	1197	1219
N25MMC	1059	1094	1124	1154	1185	1221	1247	1281	1319	1352
N25PPC	1078	1115	1147	1179	1212	1251	1278	1315	1355	1390
N25RRC	879	916	948	980	1013	1052	1079	1116	1156	1191
N25SSC	830	853	873	893	914	938	955	978	1003	1025
N26AAC	869	890	908	926	945	966	982	1002	1025	1045
N26BBC	921	956	986	1016	1047	1083	1109	1143	1181	1214
N26CCC	1018	1039	1057	1075	1094	1115	1131	1151	1174	1194
N26CCCD	1130	1151	1169	1187	1206	1227	1243	1263	1286	1306
N26DDC	1040	1063	1083	1103	1124	1148	1165	1188	1213	1235
N26DDCD	1153	1176	1196	1216	1237	1261	1278	1301	1326	1348
N26DDCX	1131	1154	1174	1194	1215	1239	1256	1279	1304	1326
N26DDCXD	1243	1266	1286	1306	1327	1351	1368	1391	1416	1438
N26EEC	1072	1107	1137	1167	1198	1234	1260	1294	1332	1365
N26EECD	1184	1219	1249	1279	1310	1346	1372	1406	1444	1477
N26HHC	1093	1130	1162	1194	1227	1266	1293	1330	1370	1405
N26HHCD	1205	1242	1274	1306	1339	1378	1405	1442	1482	1517
N26JJC	1098	1119	1137	1155	1174	1195	1211	1231	1254	1274
N26KKC	1122	1145	1165	1185	1206	1230	1247	1270	1295	1317
N26KKCX	1210	1233	1253	1273	1294	1318	1335	1358	1383	1405
N26MMC	1153	1188	1218	1248	1279	1315	1341	1375	1413	1446
N26PPC	1175	1212	1244	1276	1309	1348	1375	1412	1452	1487
N26RRC	972	1009	1041	1073	1106	1145	1172	1209	1249	1284
N26SSC	921	944	964	984	1005	1029	1046	1069	1094	1116
N30GM1UN	564	585	603	621	640	661	677	697	720	740
N30GM1UNC	564	585	603	621	640	661	677	697	720	740
N30GM1UP	539	560	578	596	615	636	652	672	695	715

Model Number	Alliance Program Price Grades									
	K	L	M	N	O	P	Q	R	S	T
N25AACY	\$ 1143	\$ 1211	\$ 1251	\$ 1274	\$ 1295	\$ 1316	\$ 1337	\$ 1358	\$ 1380	\$ 1400
N25BBC	1173	1286	1353	1391	1427	1461	1497	1532	1568	1602
N25BBCY	1336	1449	1516	1554	1590	1624	1660	1695	1731	1765
N25CCC	1131	1199	1239	1262	1283	1304	1325	1346	1368	1388
N25CCCD	1243	1311	1351	1374	1395	1416	1437	1458	1480	1500
N25CCCX	1224	1292	1332	1355	1376	1397	1418	1439	1461	1481
N25CCCXD	1336	1404	1444	1467	1488	1509	1530	1551	1573	1593
N25CCCY	1456	1569	1636	1674	1710	1744	1780	1815	1851	1885
N25CCCYD	1568	1681	1748	1786	1822	1856	1892	1927	1963	1997
N25DDC	1175	1250	1295	1320	1344	1367	1391	1414	1438	1461
N25DDCD	1288	1363	1408	1433	1457	1480	1504	1527	1551	1574
N25DDCX	1266	1341	1386	1411	1435	1458	1482	1505	1529	1552
N25DDCXD	1378	1453	1498	1523	1547	1570	1594	1617	1641	1664
N25EEC	1326	1439	1506	1544	1580	1614	1650	1685	1721	1755
N25EECD	1438	1551	1618	1656	1692	1726	1762	1797	1833	1867
N25EECY	1488	1601	1668	1706	1742	1776	1812	1847	1883	1917
N25EECYD	1600	1713	1780	1818	1854	1888	1924	1959	1995	2029
N25HHC	1367	1487	1559	1599	1637	1674	1713	1749	1788	1825
N25HHCD	1481	1601	1673	1713	1751	1788	1827	1863	1902	1939
N25JJC	1213	1281	1321	1344	1365	1386	1407	1428	1450	1470
N25KKC	1256	1331	1376	1401	1425	1448	1472	1495	1519	1542
N25MMC	1407	1520	1587	1625	1661	1695	1731	1766	1802	1836
N25PPC	1449	1569	1641	1681	1719	1756	1795	1831	1870	1907
N25RRC	1250	1370	1442	1482	1520	1557	1596	1632	1671	1708
N25SSC	1062	1137	1182	1207	1231	1254	1278	1301	1325	1348
N26AAC	1078	1146	1186	1209	1230	1251	1272	1293	1315	1335
N26BBC	1269	1382	1449	1487	1523	1557	1593	1628	1664	1698
N26CCC	1227	1295	1335	1358	1379	1400	1421	1442	1464	1484
N26CCCD	1339	1407	1447	1470	1491	1512	1533	1554	1576	1596
N26DDC	1272	1347	1392	1417	1441	1464	1488	1511	1535	1558
N26DDCD	1385	1460	1505	1530	1554	1577	1601	1624	1648	1671
N26DDCX	1363	1438	1483	1508	1532	1555	1579	1602	1626	1649
N26DDCXD	1475	1550	1595	1620	1644	1667	1691	1714	1738	1761
N26EEC	1420	1533	1600	1638	1674	1708	1744	1779	1815	1849
N26EECD	1532	1645	1712	1750	1786	1820	1856	1891	1927	1961
N26HHC	1464	1584	1656	1696	1734	1771	1810	1846	1885	1922
N26HHCD	1576	1696	1768	1808	1846	1883	1922	1958	1997	2034
N26JJC	1307	1375	1415	1438	1459	1480	1501	1522	1544	1564
N26KKC	1354	1429	1474	1499	1523	1546	1570	1593	1617	1640
N26KKCX	1442	1517	1562	1587	1611	1634	1658	1681	1705	1728
N26MMC	1501	1614	1681	1719	1755	1789	1825	1860	1896	1930
N26PPC	1546	1666	1738	1778	1816	1853	1892	1928	1967	2004
N26RRC	1343	1463	1535	1575	1613	1650	1689	1725	1764	1801
N26SSC	1153	1228	1273	1298	1322	1345	1369	1392	1416	1439
N30GM1UN	773	841	881	904	925	946	967	988	1010	1030
N30GM1UNC	773	841	881	904	925	946	967	988	1010	1030
N30GM1UP	748	816	856	879	900	921	942	963	985	1005

Alliance Program Pricing

Finishes

IM	Brighton	CW	Cordovan
NM	Natural	DW	Judicial
HN	Honey	MH	Mocha
CL	Caramel	405	Designer White
TF	Truffle	462	Cinder
AC	Autumn	792	Sable
MC	Amber	793	Acorn

To order, specify the following:

1. Chair Model Number
2. Fabric Grade Letter
3. Alliance Pattern Number and Color Number/Name
4. Finish Number (when applicable)

Sample Order Number

<u>N14KK</u>	<u>A</u>	<u>403901</u>	<u>036</u>	<u>HN</u>
Model Number	Fabric Grade Letter	Alliance Pattern Number	Alliance Color Number	Finish

Model Number

Alliance Program Price Grades

	A	B	C	D	E	F	G	H	I	J
N30GM1UPC	\$ 539	\$ 560	\$ 578	\$ 596	\$ 615	\$ 636	\$ 652	\$ 672	\$ 695	\$ 715
N30GM9UN	615	636	654	672	691	712	728	748	771	791
N30GM9UNC	615	636	654	672	691	712	728	748	771	791
N30GM9UP	590	611	629	647	666	687	703	723	746	766
N30GM9UPC	590	611	629	647	666	687	703	723	746	766
N30GP1PN	553	567	579	591	603	618	628	642	657	670
N30GP1PNC	553	567	579	591	603	618	628	642	657	670
N30GP1PP	528	542	554	566	578	593	603	617	632	645
N30GP1PPC	528	542	554	566	578	593	603	617	632	645
N30GP1UN	615	636	654	672	691	712	728	748	771	791
N30GP1UNC	615	636	654	672	691	712	728	748	771	791
N30GP1UNCX										
N30GP1UNX										
N30GP1UP	590	611	629	647	666	687	703	723	746	766
N30GP1UPC	590	611	629	647	666	687	703	723	746	766
N30GP1UPCX										
N30GP1UPX										
N30GP9PN	604	618	630	642	654	669	679	693	708	721
N30GP9PNC	604	618	630	642	654	669	679	693	708	721
N30GP9PP	579	593	605	617	629	644	654	668	683	696
N30GP9PPC	579	593	605	617	629	644	654	668	683	696
N30GP9UN	665	686	704	722	741	762	778	798	821	841
N30GP9UNC	665	686	704	722	741	762	778	798	821	841
N30GP9UNCX										
N30GP9UNX										
N30GP9UP	640	661	679	697	716	737	753	773	796	816
N30GP9UPC	640	661	679	697	716	737	753	773	796	816
N30GP9UPCX										
N30GP9UPX										
N30GU1PN	604	618	630	642	654	669	679	693	708	721
N30GU1PNC	604	618	630	642	654	669	679	693	708	721
N30GU1PNCX										
N30GU1PNX										
N30GU1PP	579	593	605	617	629	644	654	668	683	696
N30GU1PPC	579	593	605	617	629	644	654	668	683	696
N30GU1PPCX										
N30GU1PPX										
N30GU1UN	665	686	704	722	741	762	778	798	821	841
N30GU1UNC	665	686	704	722	741	762	778	798	821	841
N30GU1UNCX										
N30GU1UNX										
N30GU1UP	640	661	679	697	716	737	753	773	796	816
N30GU1UPC	640	661	679	697	716	737	753	773	796	816
N30GU1UPCX										
N30GU1UPX										

Model Number

Alliance Program Price Grades

K L M N O P Q R S T

N30GM1UPC	\$ 748	\$ 816	\$ 856	\$ 879	\$ 900	\$ 921	\$ 942	\$ 963	\$ 985	\$ 1005
N30GM9UN	824	892	932	955	976	997	1018	1039	1061	1081
N30GM9UNC	824	892	932	955	976	997	1018	1039	1061	1081
N30GM9UP	799	867	907	930	951	972	993	1014	1036	1056
N30GM9UPC	799	867	907	930	951	972	993	1014	1036	1056
N30GP1PN	692	737	764	779	793	807	822	835	850	864
N30GP1PNC	692	737	764	779	793	807	822	835	850	864
N30GP1PP	667	712	739	754	768	782	797	810	825	839
N30GP1PPC	667	712	739	754	768	782	797	810	825	839
N30GP1UN	824	892	932	955	976	997	1018	1039	1061	1081
N30GP1UNC	824	892	932	955	976	997	1018	1039	1061	1081
N30GP1UNCX										
N30GP1UNX										
N30GP1UP	799	867	907	930	951	972	993	1014	1036	1056
N30GP1UPC	799	867	907	930	951	972	993	1014	1036	1056
N30GP1UPCX										
N30GP1UPX										
N30GP9PN	743	788	815	830	844	858	873	886	901	915
N30GP9PNC	743	788	815	830	844	858	873	886	901	915
N30GP9PP	718	763	790	805	819	833	848	861	876	890
N30GP9PPC	718	763	790	805	819	833	848	861	876	890
N30GP9UN	874	942	982	1005	1026	1047	1068	1089	1111	1131
N30GP9UNC	874	942	982	1005	1026	1047	1068	1089	1111	1131
N30GP9UNCX										
N30GP9UNX										
N30GP9UP	849	917	957	980	1001	1022	1043	1064	1086	1106
N30GP9UPC	849	917	957	980	1001	1022	1043	1064	1086	1106
N30GP9UPCX										
N30GP9UPX										
N30GU1PN	743	788	815	830	844	858	873	886	901	915
N30GU1PNC	743	788	815	830	844	858	873	886	901	915
N30GU1PNCX										
N30GU1PNX										
N30GU1PP	718	763	790	805	819	833	848	861	876	890
N30GU1PPC	718	763	790	805	819	833	848	861	876	890
N30GU1PPCX										
N30GU1PPX										
N30GU1UN	874	942	982	1005	1026	1047	1068	1089	1111	1131
N30GU1UNC	874	942	982	1005	1026	1047	1068	1089	1111	1131
N30GU1UNCX										
N30GU1UNX										
N30GU1UP	849	917	957	980	1001	1022	1043	1064	1086	1106
N30GU1UPC	849	917	957	980	1001	1022	1043	1064	1086	1106
N30GU1UPCX										
N30GU1UPX										

Alliance Program Pricing

Finishes

IM	Brighton	CW	Cordovan
NM	Natural	DW	Judicial
HN	Honey	MH	Mocha
CL	Caramel	405	Designer White
TF	Truffle	462	Cinder
AC	Autumn	792	Sable
MC	Amber	793	Acorn

To order, specify the following:

1. Chair Model Number
2. Fabric Grade Letter
3. Alliance Pattern Number and Color Number/Name
4. Finish Number (when applicable)

Sample Order Number

<u>N14KK</u>	<u>A</u>	<u>403901</u>	<u>036</u>	<u>HN</u>
Model Number	Fabric Grade Letter	Alliance Pattern Number	Alliance Color Number	Finish

Model Number

Alliance Program Price Grades

	A	B	C	D	E	F	G	H	I	J
N30GU9PN	\$ 654	\$ 668	\$ 680	\$ 692	\$ 704	\$ 719	\$ 729	\$ 743	\$ 758	\$ 771
N30GU9PNC	654	668	680	692	704	719	729	743	758	771
N30GU9PNCX										
N30GU9PNX										
N30GU9PP	629	643	655	667	679	694	704	718	733	746
N30GU9PPC	629	643	655	667	679	694	704	718	733	746
N30GU9PPCX										
N30GU9PPX										
N30GU9UN	716	737	755	773	792	813	829	849	872	892
N30GU9UNC	716	737	755	773	792	813	829	849	872	892
N30GU9UNCX										
N30GU9UNX										
N30GU9UP	691	712	730	748	767	788	804	824	847	867
N30GU9UPC	691	712	730	748	767	788	804	824	847	867
N30GU9UPCX										
N30GU9UPX										
N30HM1SN	798	817	833	849	866	885	898	917	937	954
N30HM1SP	697	716	732	748	765	784	797	816	836	853
N30HM1SSN	889	908	924	940	957	976	989	1008	1028	1045
N30HM1SSP	788	807	823	839	856	875	888	907	927	944
N30HM2SN	899	918	934	950	967	986	999	1018	1038	1055
N30HM2SP	798	817	833	849	866	885	898	917	937	954
N30HM2SSN	990	1009	1025	1041	1058	1077	1090	1109	1129	1146
N30HM2SSP	889	908	924	940	957	976	989	1008	1028	1045
N30HM3SN	949	968	984	1000	1017	1036	1049	1068	1088	1105
N30HM3SP	848	867	883	899	916	935	948	967	987	1004
N30HM3SSN	1040	1059	1075	1091	1108	1127	1140	1159	1179	1196
N30HM3SSP	939	958	974	990	1007	1026	1039	1058	1078	1095
N30HM8SN	1050	1069	1085	1101	1118	1137	1150	1169	1189	1206
N30HM8SSN	1141	1160	1176	1192	1209	1228	1241	1260	1280	1297
N30HM9SN	848	867	883	899	916	935	948	967	987	1004
N30HM9SP	747	766	782	798	815	834	847	866	886	903
N30HM9SSN	939	958	974	990	1007	1026	1039	1058	1078	1095
N30HM9SSP	838	857	873	889	906	925	938	957	977	994
N30HML1SN	873	892	908	924	941	960	973	992	1012	1029
N30HML1SP	772	791	807	823	840	859	872	891	911	928
N30HML1SSN	964	983	999	1015	1032	1051	1064	1083	1103	1120
N30HML1SSP	863	882	898	914	931	950	963	982	1002	1019
N30HML2SN	974	993	1009	1025	1042	1061	1074	1093	1113	1130
N30HML2SP	873	892	908	924	941	960	973	992	1012	1029
N30HML2SSN	1065	1084	1100	1116	1133	1152	1165	1184	1204	1221
N30HML2SSP	964	983	999	1015	1032	1051	1064	1083	1103	1120
N30HML3SN	1025	1044	1060	1076	1093	1112	1125	1144	1164	1181
N30HML3SP	924	943	959	975	992	1011	1024	1043	1063	1080
N30HML3SSN	1116	1135	1151	1167	1184	1203	1216	1235	1255	1272

Model Number	Alliance Program Price Grades									
	K	L	M	N	O	P	Q	R	S	T
N30GU9PN	\$ 793	\$ 838	\$ 865	\$ 880	\$ 894	\$ 908	\$ 923	\$ 936	\$ 951	\$ 965
N30GU9PNC	793	838	865	880	894	908	923	936	951	965
N30GU9PNCX										
N30GU9PNX										
N30GU9PP	768	813	840	855	869	883	898	911	926	940
N30GU9PPC	768	813	840	855	869	883	898	911	926	940
N30GU9PPCX										
N30GU9PPX										
N30GU9UN	925	993	1033	1056	1077	1098	1119	1140	1162	1182
N30GU9UNC	925	993	1033	1056	1077	1098	1119	1140	1162	1182
N30GU9UNCX										
N30GU9UNX										
N30GU9UP	900	968	1008	1031	1052	1073	1094	1115	1137	1157
N30GU9UPC	900	968	1008	1031	1052	1073	1094	1115	1137	1157
N30GU9UPCX										
N30GU9UPX										
N30HM1SN	984	1044	1080	1100	1119	1138	1157	1175	1194	1213
N30HM1SP	883	943	979	999	1018	1037	1056	1074	1093	1112
N30HM1SSN	1075	1135	1171	1191	1210	1229	1248	1266	1285	1304
N30HM1SSP	974	1034	1070	1090	1109	1128	1147	1165	1184	1203
N30HM2SN	1085	1145	1181	1201	1220	1239	1258	1276	1295	1314
N30HM2SP	984	1044	1080	1100	1119	1138	1157	1175	1194	1213
N30HM2SSN	1176	1236	1272	1292	1311	1330	1349	1367	1386	1405
N30HM2SSP	1075	1135	1171	1191	1210	1229	1248	1266	1285	1304
N30HM3SN	1135	1195	1231	1251	1270	1289	1308	1326	1345	1364
N30HM3SP	1034	1094	1130	1150	1169	1188	1207	1225	1244	1263
N30HM3SSN	1226	1286	1322	1342	1361	1380	1399	1417	1436	1455
N30HM3SSP	1125	1185	1221	1241	1260	1279	1298	1316	1335	1354
N30HM8SN	1236	1296	1332	1352	1371	1390	1409	1427	1446	1465
N30HM8SSN	1327	1387	1423	1443	1462	1481	1500	1518	1537	1556
N30HM9SN	1034	1094	1130	1150	1169	1188	1207	1225	1244	1263
N30HM9SP	933	993	1029	1049	1068	1087	1106	1124	1143	1162
N30HM9SSN	1125	1185	1221	1241	1260	1279	1298	1316	1335	1354
N30HM9SSP	1024	1084	1120	1140	1159	1178	1197	1215	1234	1253
N30HML1SN	1059	1119	1155	1175	1194	1213	1232	1250	1269	1288
N30HML1SP	958	1018	1054	1074	1093	1112	1131	1149	1168	1187
N30HML1SSN	1150	1210	1246	1266	1285	1304	1323	1341	1360	1379
N30HML1SSP	1049	1109	1145	1165	1184	1203	1222	1240	1259	1278
N30HML2SN	1160	1220	1256	1276	1295	1314	1333	1351	1370	1389
N30HML2SP	1059	1119	1155	1175	1194	1213	1232	1250	1269	1288
N30HML2SSN	1251	1311	1347	1367	1386	1405	1424	1442	1461	1480
N30HML2SSP	1150	1210	1246	1266	1285	1304	1323	1341	1360	1379
N30HML3SN	1211	1271	1307	1327	1346	1365	1384	1402	1421	1440
N30HML3SP	1110	1170	1206	1226	1245	1264	1283	1301	1320	1339
N30HML3SSN	1302	1362	1398	1418	1437	1456	1475	1493	1512	1531

Alliance Program Pricing

Finishes

IM	Brighton	CW	Cordovan
NM	Natural	DW	Judicial
HN	Honey	MH	Mocha
CL	Caramel	405	Designer White
TF	Truffle	462	Cinder
AC	Autumn	792	Sable
MC	Amber	793	Acorn

To order, specify the following:

1. Chair Model Number
2. Fabric Grade Letter
3. Alliance Pattern Number and Color Number/Name
4. Finish Number (when applicable)

Sample Order Number

<u>N14KK</u>	<u>A</u>	<u>403901</u>	<u>036</u>	<u>HN</u>
Model Number	Fabric Grade Letter	Alliance Pattern Number	Alliance Color Number	Finish

Model Number

Alliance Program Price Grades

	A	B	C	D	E	F	G	H	I	J
N30HML3SSP	\$ 1015	\$ 1034	\$ 1050	\$ 1066	\$ 1083	\$ 1102	\$ 1115	\$ 1134	\$ 1154	\$ 1171
N30HML8SN	1126	1145	1161	1177	1194	1213	1226	1245	1265	1282
N30HML8SSN	1217	1236	1252	1268	1285	1304	1317	1336	1356	1373
N30HML9SN	924	943	959	975	992	1011	1024	1043	1063	1080
N30HML9SP	823	842	858	874	891	910	923	942	962	979
N30HML9SSN	1015	1034	1050	1066	1083	1102	1115	1134	1154	1171
N30HML9SSP	914	933	949	965	982	1001	1014	1033	1053	1070
N30HP1SN	938	968	994	1020	1048	1079	1101	1131	1163	1192
N30HP1SNX										
N30HP1SP	837	867	893	919	947	978	1000	1030	1062	1091
N30HP1SPX										
N30HP1SSN	1029	1059	1085	1111	1139	1170	1192	1222	1254	1283
N30HP1SSNX										
N30HP1SSP	928	958	984	1010	1038	1069	1091	1121	1153	1182
N30HP1SSPX										
N30HP2SN	1039	1069	1095	1121	1149	1180	1202	1232	1264	1293
N30HP2SNX										
N30HP2SP	938	968	994	1020	1048	1079	1101	1131	1163	1192
N30HP2SPX										
N30HP2SSN	1130	1160	1186	1212	1240	1271	1293	1323	1355	1384
N30HP2SSNX										
N30HP2SSP	1029	1059	1085	1111	1139	1170	1192	1222	1254	1283
N30HP2SSPX										
N30HP3SN	1089	1119	1145	1171	1199	1230	1252	1282	1314	1343
N30HP3SNX										
N30HP3SP	988	1018	1044	1070	1098	1129	1151	1181	1213	1242
N30HP3SPX										
N30HP3SSN	1180	1210	1236	1262	1290	1321	1343	1373	1405	1434
N30HP3SSNX										
N30HP3SSP	1079	1109	1135	1161	1189	1220	1242	1272	1304	1333
N30HP3SSPX										
N30HP8SN	1190	1220	1246	1272	1300	1331	1353	1383	1415	1444
N30HP8SNX										
N30HP8SSN	1281	1311	1337	1363	1391	1422	1444	1474	1506	1535
N30HP8SSNX										
N30HP9SN	988	1018	1044	1070	1098	1129	1151	1181	1213	1242
N30HP9SNX										
N30HP9SP	887	917	943	969	997	1028	1050	1080	1112	1141
N30HP9SPX										
N30HP9SSN	1079	1109	1135	1161	1189	1220	1242	1272	1304	1333
N30HP9SSNX										
N30HP9SSP	978	1008	1034	1060	1088	1119	1141	1171	1203	1232
N30HP9SSPX										
N30HU1SN	996	1031	1061	1091	1122	1158	1184	1218	1256	1289
N30HU1SNX										

Model Number	Alliance Program Price Grades									
	K	L	M	N	O	P	Q	R	S	T
N30HML3SSP	\$ 1201	\$ 1261	\$ 1297	\$ 1317	\$ 1336	\$ 1355	\$ 1374	\$ 1392	\$ 1411	\$ 1430
N30HML8SN	1312	1372	1408	1428	1447	1466	1485	1503	1522	1541
N30HML8SSN	1403	1463	1499	1519	1538	1557	1576	1594	1613	1632
N30HML9SN	1110	1170	1206	1226	1245	1264	1283	1301	1320	1339
N30HML9SP	1009	1069	1105	1125	1144	1163	1182	1200	1219	1238
N30HML9SSN	1201	1261	1297	1317	1336	1355	1374	1392	1411	1430
N30HML9SSP	1100	1160	1196	1216	1235	1254	1273	1291	1310	1329
N30HP1SN	1240	1338	1396	1429	1460	1490	1521	1551	1582	1612
N30HP1SNX										
N30HP1SP	1139	1237	1295	1328	1359	1389	1420	1450	1481	1511
N30HP1SPX										
N30HP1SSN	1331	1429	1487	1520	1551	1581	1612	1642	1673	1703
N30HP1SSNX										
N30HP1SSP	1230	1328	1386	1419	1450	1480	1511	1541	1572	1602
N30HP1SSPX										
N30HP2SN	1341	1439	1497	1530	1561	1591	1622	1652	1683	1713
N30HP2SNX										
N30HP2SP	1240	1338	1396	1429	1460	1490	1521	1551	1582	1612
N30HP2SPX										
N30HP2SSN	1432	1530	1588	1621	1652	1682	1713	1743	1774	1804
N30HP2SSNX										
N30HP2SSP	1331	1429	1487	1520	1551	1581	1612	1642	1673	1703
N30HP2SSPX										
N30HP3SN	1391	1489	1547	1580	1611	1641	1672	1702	1733	1763
N30HP3SNX										
N30HP3SP	1290	1388	1446	1479	1510	1540	1571	1601	1632	1662
N30HP3SPX										
N30HP3SSN	1482	1580	1638	1671	1702	1732	1763	1793	1824	1854
N30HP3SSNX										
N30HP3SSP	1381	1479	1537	1570	1601	1631	1662	1692	1723	1753
N30HP3SSPX										
N30HP8SN	1492	1590	1648	1681	1712	1742	1773	1803	1834	1864
N30HP8SNX										
N30HP8SSN	1583	1681	1739	1772	1803	1833	1864	1894	1925	1955
N30HP8SSNX										
N30HP9SN	1290	1388	1446	1479	1510	1540	1571	1601	1632	1662
N30HP9SNX										
N30HP9SP	1189	1287	1345	1378	1409	1439	1470	1500	1531	1561
N30HP9SPX										
N30HP9SSN	1381	1479	1537	1570	1601	1631	1662	1692	1723	1753
N30HP9SSNX										
N30HP9SSP	1280	1378	1436	1469	1500	1530	1561	1591	1622	1652
N30HP9SSPX										
N30HU1SN	1344	1457	1524	1562	1598	1632	1668	1703	1739	1773
N30HU1SNX										

Alliance Program Pricing

Finishes

IM	Brighton	CW	Cordovan
NM	Natural	DW	Judicial
HN	Honey	MH	Mocha
CL	Caramel	405	Designer White
TF	Truffle	462	Cinder
AC	Autumn	792	Sable
MC	Amber	793	Acorn

To order, specify the following:

1. Chair Model Number
2. Fabric Grade Letter
3. Alliance Pattern Number and Color Number/Name
4. Finish Number (when applicable)

Sample Order Number

<u>N14KK</u>	<u>A</u>	<u>403901</u>	<u>036</u>	<u>HN</u>
Model Number	Fabric Grade Letter	Alliance Pattern Number	Alliance Color Number	Finish

Model Number

Alliance Program Price Grades

	A	B	C	D	E	F	G	H	I	J
N30HU1SP	\$ 895	\$ 930	\$ 960	\$ 990	\$ 1021	\$ 1057	\$ 1083	\$ 1117	\$ 1155	\$ 1188
N30HU1SPX										
N30HU1SSN	1087	1122	1152	1182	1213	1249	1275	1309	1347	1380
N30HU1SSNX										
N30HU1SSP	986	1021	1051	1081	1112	1148	1174	1208	1246	1279
N30HU1SSPX										
N30HU2SN	1097	1132	1162	1192	1223	1259	1285	1319	1357	1390
N30HU2SNX										
N30HU2SP	996	1031	1061	1091	1122	1158	1184	1218	1256	1289
N30HU2SPX										
N30HU2SSN	1188	1223	1253	1283	1314	1350	1376	1410	1448	1481
N30HU2SSNX										
N30HU2SSP	1087	1122	1152	1182	1213	1249	1275	1309	1347	1380
N30HU2SSPX										
N30HU3SN	1148	1183	1213	1243	1274	1310	1336	1370	1408	1441
N30HU3SNX										
N30HU3SP	1047	1082	1112	1142	1173	1209	1235	1269	1307	1340
N30HU3SPX										
N30HU3SSN	1239	1274	1304	1334	1365	1401	1427	1461	1499	1532
N30HU3SSNX										
N30HU3SSP	1138	1173	1203	1233	1264	1300	1326	1360	1398	1431
N30HU3SSPX										
N30HU8SN	1249	1284	1314	1344	1375	1411	1437	1471	1509	1542
N30HU8SNX										
N30HU8SSN	1340	1375	1405	1435	1466	1502	1528	1562	1600	1633
N30HU8SSNX										
N30HU9SN	1047	1082	1112	1142	1173	1209	1235	1269	1307	1340
N30HU9SNX										
N30HU9SP	946	981	1011	1041	1072	1108	1134	1168	1206	1239
N30HU9SPX										
N30HU9SSN	1138	1173	1203	1233	1264	1300	1326	1360	1398	1431
N30HU9SSNX										
N30HU9SSP	1037	1072	1102	1132	1163	1199	1225	1259	1297	1330
N30HU9SSPX										
N30MP1SN	889	916	940	964	989	1018	1039	1066	1096	1123
N30MP1SNX										
N30MP1SP	788	815	839	863	888	917	938	965	995	1022
N30MP1SPX										
N30MP1SSN	980	1007	1031	1055	1080	1109	1130	1157	1187	1214
N30MP1SSNX										
N30MP1SSP	879	906	930	954	979	1008	1029	1056	1086	1113
N30MP1SSPX										
N30MP2SN	990	1017	1041	1065	1090	1119	1140	1167	1197	1224
N30MP2SNX										
N30MP2SP	889	916	940	964	989	1018	1039	1066	1096	1123

Model Number	Alliance Program Price Grades									
	K	L	M	N	O	P	Q	R	S	T
N30HU1SP	\$ 1243	\$ 1356	\$ 1423	\$ 1461	\$ 1497	\$ 1531	\$ 1567	\$ 1602	\$ 1638	\$ 1672
N30HU1SPX										
N30HU1SSN	1435	1548	1615	1653	1689	1723	1759	1794	1830	1864
N30HU1SSNX										
N30HU1SSP	1334	1447	1514	1552	1588	1622	1658	1693	1729	1763
N30HU1SSPX										
N30HU2SN	1445	1558	1625	1663	1699	1733	1769	1804	1840	1874
N30HU2SNX										
N30HU2SP	1344	1457	1524	1562	1598	1632	1668	1703	1739	1773
N30HU2SPX										
N30HU2SSN	1536	1649	1716	1754	1790	1824	1860	1895	1931	1965
N30HU2SSNX										
N30HU2SSP	1435	1548	1615	1653	1689	1723	1759	1794	1830	1864
N30HU2SSPX										
N30HU3SN	1496	1609	1676	1714	1750	1784	1820	1855	1891	1925
N30HU3SNX										
N30HU3SP	1395	1508	1575	1613	1649	1683	1719	1754	1790	1824
N30HU3SPX										
N30HU3SSN	1587	1700	1767	1805	1841	1875	1911	1946	1982	2016
N30HU3SSNX										
N30HU3SSP	1486	1599	1666	1704	1740	1774	1810	1845	1881	1915
N30HU3SSPX										
N30HU8SN	1597	1710	1777	1815	1851	1885	1921	1956	1992	2026
N30HU8SNX										
N30HU8SSN	1688	1801	1868	1906	1942	1976	2012	2047	2083	2117
N30HU8SSNX										
N30HU9SN	1395	1508	1575	1613	1649	1683	1719	1754	1790	1824
N30HU9SNX										
N30HU9SP	1294	1407	1474	1512	1548	1582	1618	1653	1689	1723
N30HU9SPX										
N30HU9SSN	1486	1599	1666	1704	1740	1774	1810	1845	1881	1915
N30HU9SSNX										
N30HU9SSP	1385	1498	1565	1603	1639	1673	1709	1744	1780	1814
N30HU9SSPX										
N30MP1SN	1167	1257	1311	1341	1370	1397	1426	1454	1483	1510
N30MP1SNX										
N30MP1SP	1066	1156	1210	1240	1269	1296	1325	1353	1382	1409
N30MP1SPX										
N30MP1SSN	1258	1348	1402	1432	1461	1488	1517	1545	1574	1601
N30MP1SSNX										
N30MP1SSP	1157	1247	1301	1331	1360	1387	1416	1444	1473	1500
N30MP1SSPX										
N30MP2SN	1268	1358	1412	1442	1471	1498	1527	1555	1584	1611
N30MP2SNX										
N30MP2SP	1167	1257	1311	1341	1370	1397	1426	1454	1483	1510

Alliance Program Pricing

Finishes

IM	Brighton	CW	Cordovan
NM	Natural	DW	Judicial
HN	Honey	MH	Mocha
CL	Caramel	405	Designer White
TF	Truffle	462	Cinder
AC	Autumn	792	Sable
MC	Amber	793	Acorn

To order, specify the following:

1. Chair Model Number
2. Fabric Grade Letter
3. Alliance Pattern Number and Color Number/Name
4. Finish Number (when applicable)

Sample Order Number

<u>N14KK</u>	<u>A</u>	<u>403901</u>	<u>036</u>	<u>HN</u>
Model Number	Fabric Grade Letter	Alliance Pattern Number	Alliance Color Number	Finish

Model Number

Alliance Program Price Grades

	A	B	C	D	E	F	G	H	I	J
N30MP2SPX	\$	\$	\$	\$	\$	\$	\$	\$	\$	\$
N30MP2SSN	1081	1108	1132	1156	1181	1210	1231	1258	1288	1315
N30MP2SSNX										
N30MP2SSP	980	1007	1031	1055	1080	1109	1130	1157	1187	1214
N30MP2SSPX										
N30MP3SN	1041	1068	1092	1116	1141	1170	1191	1218	1248	1275
N30MP3SNX										
N30MP3SP	940	967	991	1015	1040	1069	1090	1117	1147	1174
N30MP3SPX										
N30MP3SSN	1132	1159	1183	1207	1232	1261	1282	1309	1339	1366
N30MP3SSNX										
N30MP3SSP	1031	1058	1082	1106	1131	1160	1181	1208	1238	1265
N30MP3SSPX										
N30MP8SN	1142	1169	1193	1217	1242	1271	1292	1319	1349	1376
N30MP8SNX										
N30MP8SSN	1233	1260	1284	1308	1333	1362	1383	1410	1440	1467
N30MP8SSNX										
N30MP9SN	940	967	991	1015	1040	1069	1090	1117	1147	1174
N30MP9SNX										
N30MP9SP	839	866	890	914	939	968	989	1016	1046	1073
N30MP9SPX										
N30MP9SSN	1031	1058	1082	1106	1131	1160	1181	1208	1238	1265
N30MP9SSNX										
N30MP9SSP	930	957	981	1005	1030	1059	1080	1107	1137	1164
N30MP9SSPX										
N30MU1SN	947	979	1007	1035	1065	1098	1122	1154	1189	1220
N30MU1SNX										
N30MU1SP	846	878	906	934	964	997	1021	1053	1088	1119
N30MU1SPX										
N30MU1SSN	1038	1070	1098	1126	1156	1189	1213	1245	1280	1311
N30MU1SSNX										
N30MU1SSP	937	969	997	1025	1055	1088	1112	1144	1179	1210
N30MU1SSPX										
N30MU2SN	1048	1080	1108	1136	1166	1199	1223	1255	1290	1321
N30MU2SNX										
N30MU2SP	947	979	1007	1035	1065	1098	1122	1154	1189	1220
N30MU2SPX										
N30MU2SSN	1139	1171	1199	1227	1257	1290	1314	1346	1381	1412
N30MU2SSNX										
N30MU2SSP	1038	1070	1098	1126	1156	1189	1213	1245	1280	1311
N30MU2SSPX										
N30MU3SN	1098	1130	1158	1186	1216	1249	1273	1305	1340	1371
N30MU3SNX										
N30MU3SP	997	1029	1057	1085	1115	1148	1172	1204	1239	1270
N30MU3SPX										

Model Number	Alliance Program Price Grades									
	K	L	M	N	O	P	Q	R	S	T
N30MP2SPX	\$	\$	\$	\$	\$	\$	\$	\$	\$	\$
N30MP2SSN	1359	1449	1503	1533	1562	1589	1618	1646	1675	1702
N30MP2SSNX										
N30MP2SSP	1258	1348	1402	1432	1461	1488	1517	1545	1574	1601
N30MP2SSPX										
N30MP3SN	1319	1409	1463	1493	1522	1549	1578	1606	1635	1662
N30MP3SNX										
N30MP3SP	1218	1308	1362	1392	1421	1448	1477	1505	1534	1561
N30MP3SPX										
N30MP3SSN	1410	1500	1554	1584	1613	1640	1669	1697	1726	1753
N30MP3SSNX										
N30MP3SSP	1309	1399	1453	1483	1512	1539	1568	1596	1625	1652
N30MP3SSPX										
N30MP8SN	1420	1510	1564	1594	1623	1650	1679	1707	1736	1763
N30MP8SNX										
N30MP8SSN	1511	1601	1655	1685	1714	1741	1770	1798	1827	1854
N30MP8SSNX										
N30MP9SN	1218	1308	1362	1392	1421	1448	1477	1505	1534	1561
N30MP9SNX										
N30MP9SP	1117	1207	1261	1291	1320	1347	1376	1404	1433	1460
N30MP9SPX										
N30MP9SSN	1309	1399	1453	1483	1512	1539	1568	1596	1625	1652
N30MP9SSNX										
N30MP9SSP	1208	1298	1352	1382	1411	1438	1467	1495	1524	1551
N30MP9SSPX										
N30MU1SN	1272	1377	1440	1475	1509	1541	1574	1607	1640	1672
N30MU1SNX										
N30MU1SP	1171	1276	1339	1374	1408	1440	1473	1506	1539	1571
N30MU1SPX										
N30MU1SSN	1363	1468	1531	1566	1600	1632	1665	1698	1731	1763
N30MU1SSNX										
N30MU1SSP	1262	1367	1430	1465	1499	1531	1564	1597	1630	1662
N30MU1SSPX										
N30MU2SN	1373	1478	1541	1576	1610	1642	1675	1708	1741	1773
N30MU2SNX										
N30MU2SP	1272	1377	1440	1475	1509	1541	1574	1607	1640	1672
N30MU2SPX										
N30MU2SSN	1464	1569	1632	1667	1701	1733	1766	1799	1832	1864
N30MU2SSNX										
N30MU2SSP	1363	1468	1531	1566	1600	1632	1665	1698	1731	1763
N30MU2SSPX										
N30MU3SN	1423	1528	1591	1626	1660	1692	1725	1758	1791	1823
N30MU3SNX										
N30MU3SP	1322	1427	1490	1525	1559	1591	1624	1657	1690	1722
N30MU3SPX										

Alliance Program Pricing

Finishes

IM	Brighton	CW	Cordovan
NM	Natural	DW	Judicial
HN	Honey	MH	Mocha
CL	Caramel	405	Designer White
TF	Truffle	462	Cinder
AC	Autumn	792	Sable
MC	Amber	793	Acorn

To order, specify the following:

1. Chair Model Number
2. Fabric Grade Letter
3. Alliance Pattern Number and Color Number/Name
4. Finish Number (when applicable)

Sample Order Number

<u>N14KK</u>	<u>A</u>	<u>403901</u>	<u>036</u>	<u>HN</u>
Model Number	Fabric Grade Letter	Alliance Pattern Number	Alliance Color Number	Finish

Model Number

Alliance Program Price Grades

	A	B	C	D	E	F	G	H	I	J
N30MU3SSN	\$ 1189	\$ 1221	\$ 1249	\$ 1277	\$ 1307	\$ 1340	\$ 1364	\$ 1396	\$ 1431	\$ 1462
N30MU3SSNX										
N30MU3SSP	1088	1120	1148	1176	1206	1239	1263	1295	1330	1361
N30MU3SSPX										
N30MU8SN	1199	1231	1259	1287	1317	1350	1374	1406	1441	1472
N30MU8SNX										
N30MU8SSN	1290	1322	1350	1378	1408	1441	1465	1497	1532	1563
N30MU8SSNX										
N30MU9SN	997	1029	1057	1085	1115	1148	1172	1204	1239	1270
N30MU9SNX										
N30MU9SP	896	928	956	984	1014	1047	1071	1103	1138	1169
N30MU9SPX										
N30MU9SSN	1088	1120	1148	1176	1206	1239	1263	1295	1330	1361
N30MU9SSNX										
N30MU9SSP	987	1019	1047	1075	1105	1138	1162	1194	1229	1260
N30MU9SSPX										
N30SP1SN	915	942	966	990	1015	1044	1065	1092	1122	1149
N30SP1SNG	915	942	966	990	1015	1044	1065	1092	1122	1149
N30SP1SNGX										
N30SP1SNX										
N30SP1SP	814	841	865	889	914	943	964	991	1021	1048
N30SP1SPG	814	841	865	889	914	943	964	991	1021	1048
N30SP1SPGX										
N30SP1SPX										
N30SP2SN	1016	1043	1067	1091	1116	1145	1166	1193	1223	1250
N30SP2SNG	1016	1043	1067	1091	1116	1145	1166	1193	1223	1250
N30SP2SNGX										
N30SP2SNX										
N30SP2SP	915	942	966	990	1015	1044	1065	1092	1122	1149
N30SP2SPG	915	942	966	990	1015	1044	1065	1092	1122	1149
N30SP2SPGX										
N30SP2SPX										
N30SP3SN	1066	1093	1117	1141	1166	1195	1216	1243	1273	1300
N30SP3SNG	1066	1093	1117	1141	1166	1195	1216	1243	1273	1300
N30SP3SNGX										
N30SP3SNX										
N30SP3SP	965	992	1016	1040	1065	1094	1115	1142	1172	1199
N30SP3SPG	965	992	1016	1040	1065	1094	1115	1142	1172	1199
N30SP3SPGX										
N30SP3SPX										
N30SP8SN	1167	1194	1218	1242	1267	1296	1317	1344	1374	1401
N30SP8SNG	1167	1194	1218	1242	1267	1296	1317	1344	1374	1401
N30SP8SNGX										
N30SP8SNX										
N30SP9SN	965	992	1016	1040	1065	1094	1115	1142	1172	1199

Model Number	Alliance Program Price Grades									
	K	L	M	N	O	P	Q	R	S	T
N30MU3SSN	\$ 1514	\$ 1619	\$ 1682	\$ 1717	\$ 1751	\$ 1783	\$ 1816	\$ 1849	\$ 1882	\$ 1914
N30MU3SSNX										
N30MU3SSP	1413	1518	1581	1616	1650	1682	1715	1748	1781	1813
N30MU3SSPX										
N30MU8SN	1524	1629	1692	1727	1761	1793	1826	1859	1892	1924
N30MU8SNX										
N30MU8SSN	1615	1720	1783	1818	1852	1884	1917	1950	1983	2015
N30MU8SSNX										
N30MU9SN	1322	1427	1490	1525	1559	1591	1624	1657	1690	1722
N30MU9SNX										
N30MU9SP	1221	1326	1389	1424	1458	1490	1523	1556	1589	1621
N30MU9SPX										
N30MU9SSN	1413	1518	1581	1616	1650	1682	1715	1748	1781	1813
N30MU9SSNX										
N30MU9SSP	1312	1417	1480	1515	1549	1581	1614	1647	1680	1712
N30MU9SSPX										
N30SP1SN	1193	1283	1337	1367	1396	1423	1452	1480	1509	1536
N30SP1SNG	1193	1283	1337	1367	1396	1423	1452	1480	1509	1536
N30SP1SNGX										
N30SP1SNX										
N30SP1SP	1092	1182	1236	1266	1295	1322	1351	1379	1408	1435
N30SP1SPG	1092	1182	1236	1266	1295	1322	1351	1379	1408	1435
N30SP1SPGX										
N30SP1SPX										
N30SP2SN	1294	1384	1438	1468	1497	1524	1553	1581	1610	1637
N30SP2SNG	1294	1384	1438	1468	1497	1524	1553	1581	1610	1637
N30SP2SNGX										
N30SP2SNX										
N30SP2SP	1193	1283	1337	1367	1396	1423	1452	1480	1509	1536
N30SP2SPG	1193	1283	1337	1367	1396	1423	1452	1480	1509	1536
N30SP2SPGX										
N30SP2SPX										
N30SP3SN	1344	1434	1488	1518	1547	1574	1603	1631	1660	1687
N30SP3SNG	1344	1434	1488	1518	1547	1574	1603	1631	1660	1687
N30SP3SNGX										
N30SP3SNX										
N30SP3SP	1243	1333	1387	1417	1446	1473	1502	1530	1559	1586
N30SP3SPG	1243	1333	1387	1417	1446	1473	1502	1530	1559	1586
N30SP3SPGX										
N30SP3SPX										
N30SP8SN	1445	1535	1589	1619	1648	1675	1704	1732	1761	1788
N30SP8SNG	1445	1535	1589	1619	1648	1675	1704	1732	1761	1788
N30SP8SNGX										
N30SP8SNX										
N30SP9SN	1243	1333	1387	1417	1446	1473	1502	1530	1559	1586

Alliance Program Pricing

Finishes

IM	Brighton	CW	Cordovan
NM	Natural	DW	Judicial
HN	Honey	MH	Mocha
CL	Caramel	405	Designer White
TF	Truffle	462	Cinder
AC	Autumn	792	Sable
MC	Amber	793	Acorn

To order, specify the following:

1. Chair Model Number
2. Fabric Grade Letter
3. Alliance Pattern Number and Color Number/Name
4. Finish Number (when applicable)

Sample Order Number

<u>N14KK</u>	<u>A</u>	<u>403901</u>	<u>036</u>	<u>HN</u>
Model Number	Fabric Grade Letter	Alliance Pattern Number	Alliance Color Number	Finish

Model Number

Alliance Program Price Grades

	A	B	C	D	E	F	G	H	I	J
N30SP9SNG	\$ 965	\$ 992	\$ 1016	\$ 1040	\$ 1065	\$ 1094	\$ 1115	\$ 1142	\$ 1172	\$ 1199
N30SP9SNGX										
N30SP9SNX										
N30SP9SP	864	891	915	939	964	993	1014	1041	1071	1098
N30SP9SPG	864	891	915	939	964	993	1014	1041	1071	1098
N30SP9SPGX										
N30SP9SPX										
N30SU1SN	997	1029	1057	1085	1115	1148	1172	1204	1239	1270
N30SU1SNG	997	1029	1057	1085	1115	1148	1172	1204	1239	1270
N30SU1SNGX										
N30SU1SNX										
N30SU1SP	896	928	956	984	1014	1047	1071	1103	1138	1169
N30SU1SPG	896	928	956	984	1014	1047	1071	1103	1138	1169
N30SU1SPGX										
N30SU1SPX										
N30SU2SN	1098	1130	1158	1186	1216	1249	1273	1305	1340	1371
N30SU2SNG	1098	1130	1158	1186	1216	1249	1273	1305	1340	1371
N30SU2SNGX										
N30SU2SNX										
N30SU2SP	997	1029	1057	1085	1115	1148	1172	1204	1239	1270
N30SU2SPG	997	1029	1057	1085	1115	1148	1172	1204	1239	1270
N30SU2SPGX										
N30SU2SPX										
N30SU3SN	1149	1181	1209	1237	1267	1300	1324	1356	1391	1422
N30SU3SNG	1149	1181	1209	1237	1267	1300	1324	1356	1391	1422
N30SU3SNGX										
N30SU3SNX										
N30SU3SP	1048	1080	1108	1136	1166	1199	1223	1255	1290	1321
N30SU3SPG	1048	1080	1108	1136	1166	1199	1223	1255	1290	1321
N30SU3SPGX										
N30SU3SPX										
N30SU8SN	1250	1282	1310	1338	1368	1401	1425	1457	1492	1523
N30SU8SNG	1250	1282	1310	1338	1368	1401	1425	1457	1492	1523
N30SU8SNGX										
N30SU8SNX										
N30SU9SN	1048	1080	1108	1136	1166	1199	1223	1255	1290	1321
N30SU9SNG	1048	1080	1108	1136	1166	1199	1223	1255	1290	1321
N30SU9SNGX										
N30SU9SNX										
N30SU9SP	947	979	1007	1035	1065	1098	1122	1154	1189	1220
N30SU9SPG	947	979	1007	1035	1065	1098	1122	1154	1189	1220
N30SU9SPGX										
N30SU9SPX										
N32AAM	1762	1875	1973	2071	2174	2291	2375	2487	2610	2718
N32AAMS	1853	1968	2068	2168	2273	2393	2478	2593	2718	2828

Model Number	Alliance Program Price Grades									
	K	L	M	N	O	P	Q	R	S	T
N30SP9SNG	\$ 1243	\$ 1333	\$ 1387	\$ 1417	\$ 1446	\$ 1473	\$ 1502	\$ 1530	\$ 1559	\$ 1586
N30SP9SNGX										
N30SP9SNX										
N30SP9SP	1142	1232	1286	1316	1345	1372	1401	1429	1458	1485
N30SP9SPG	1142	1232	1286	1316	1345	1372	1401	1429	1458	1485
N30SP9SPGX										
N30SP9SPX										
N30SU1SN	1322	1427	1490	1525	1559	1591	1624	1657	1690	1722
N30SU1SNG	1322	1427	1490	1525	1559	1591	1624	1657	1690	1722
N30SU1SNGX										
N30SU1SNX										
N30SU1SP	1221	1326	1389	1424	1458	1490	1523	1556	1589	1621
N30SU1SPG	1221	1326	1389	1424	1458	1490	1523	1556	1589	1621
N30SU1SPGX										
N30SU1SPX										
N30SU2SN	1423	1528	1591	1626	1660	1692	1725	1758	1791	1823
N30SU2SNG	1423	1528	1591	1626	1660	1692	1725	1758	1791	1823
N30SU2SNGX										
N30SU2SNX										
N30SU2SP	1322	1427	1490	1525	1559	1591	1624	1657	1690	1722
N30SU2SPG	1322	1427	1490	1525	1559	1591	1624	1657	1690	1722
N30SU2SPGX										
N30SU2SPX										
N30SU3SN	1474	1579	1642	1677	1711	1743	1776	1809	1842	1874
N30SU3SNG	1474	1579	1642	1677	1711	1743	1776	1809	1842	1874
N30SU3SNGX										
N30SU3SNX										
N30SU3SP	1373	1478	1541	1576	1610	1642	1675	1708	1741	1773
N30SU3SPG	1373	1478	1541	1576	1610	1642	1675	1708	1741	1773
N30SU3SPGX										
N30SU3SPX										
N30SU8SN	1575	1680	1743	1778	1812	1844	1877	1910	1943	1975
N30SU8SNG	1575	1680	1743	1778	1812	1844	1877	1910	1943	1975
N30SU8SNGX										
N30SU8SNX										
N30SU9SN	1373	1478	1541	1576	1610	1642	1675	1708	1741	1773
N30SU9SNG	1373	1478	1541	1576	1610	1642	1675	1708	1741	1773
N30SU9SNGX										
N30SU9SNX										
N30SU9SP	1272	1377	1440	1475	1509	1541	1574	1607	1640	1672
N30SU9SPG	1272	1377	1440	1475	1509	1541	1574	1607	1640	1672
N30SU9SPGX										
N30SU9SPX										
N32AAM	2899	3267	3487	3610	3727	3840	3957	4070	4188	4300
N32AAMS	3013	3388	3613	3738	3858	3973	4093	4208	4328	4443

Alliance Program Pricing

Finishes

IM	Brighton	CW	Cordovan
NM	Natural	DW	Judicial
HN	Honey	MH	Mocha
CL	Caramel	405	Designer White
TF	Truffle	462	Cinder
AC	Autumn	792	Sable
MC	Amber	793	Acorn

To order, specify the following:

1. Chair Model Number
2. Fabric Grade Letter
3. Alliance Pattern Number and Color Number/Name
4. Finish Number (when applicable)

Sample Order Number

<u>N14KK</u>	<u>A</u>	<u>403901</u>	<u>036</u>	<u>HN</u>
Model Number	Fabric Grade Letter	Alliance Pattern Number	Alliance Color Number	Finish

Model Number

Alliance Program Price Grades

	A	B	C	D	E	F	G	H	I	J
N32AAW	\$ 1878	\$ 1991	\$ 2089	\$ 2187	\$ 2290	\$ 2407	\$ 2491	\$ 2603	\$ 2726	\$ 2834
N32AAWS	1970	2085	2185	2285	2390	2510	2595	2710	2835	2945
N32BBM	1909	2022	2120	2218	2321	2438	2522	2634	2757	2865
N32BBMS	1970	2085	2185	2285	2390	2510	2595	2710	2835	2945
N32BBW	2027	2140	2238	2336	2439	2556	2640	2752	2875	2983
N32BBWS	2118	2233	2333	2433	2538	2658	2743	2858	2983	3093
N32CCML	2134	2247	2345	2443	2546	2663	2747	2859	2982	3090
N32CCMLS	2226	2341	2441	2541	2646	2766	2851	2966	3091	3201
N32CCMR	2134	2247	2345	2443	2546	2663	2747	2859	2982	3090
N32CCMRS	2226	2341	2441	2541	2646	2766	2851	2966	3091	3201
N32CCWL	2251	2364	2462	2560	2663	2780	2864	2976	3099	3207
N32CCWLS	2343	2458	2558	2658	2763	2883	2968	3083	3208	3318
N32CCWR	2251	2364	2462	2560	2663	2780	2864	2976	3099	3207
N32CCWRS	2343	2458	2558	2658	2763	2883	2968	3083	3208	3318
N32DDML	2269	2382	2480	2578	2681	2798	2882	2994	3117	3225
N32DDMLS	2360	2475	2575	2675	2780	2900	2985	3100	3225	3335
N32DDMR	2269	2382	2480	2578	2681	2798	2882	2994	3117	3225
N32DDMRS	2360	2475	2575	2675	2780	2900	2985	3100	3225	3335
N32DDWL	2385	2498	2596	2694	2797	2914	2998	3110	3233	3341
N32DDWLS	2478	2593	2693	2793	2898	3018	3103	3218	3343	3453
N32DDWR	2385	2498	2596	2694	2797	2914	2998	3110	3233	3341
N32DDWRS	2478	2593	2693	2793	2898	3018	3103	3218	3343	3453
N32HHM	2441	2648	2828	3008	3197	3413	3566	3773	3998	4196
N32HHMS	2571	2803	3005	3207	3419	3662	3833	4066	4318	4540
N32HHW	2559	2766	2946	3126	3315	3531	3684	3891	4116	4314
N32HHWS	2687	2919	3121	3323	3535	3778	3949	4182	4434	4656
N32HKM	1482	1560	1628	1696	1768	1849	1907	1985	2070	2145
N32HKW	1601	1679	1747	1815	1887	1968	2026	2104	2189	2264
N32JJMB	3185	3392	3572	3752	3941	4157	4310	4517	4742	4940
N32JJMBS	3314	3546	3748	3950	4162	4405	4576	4809	5061	5283
N32JJML	2813	3020	3200	3380	3569	3785	3938	4145	4370	4568
N32JJMLS	2941	3173	3375	3577	3789	4032	4203	4436	4688	4910
N32JJMR	2813	3020	3200	3380	3569	3785	3938	4145	4370	4568
N32JJMRS	2941	3173	3375	3577	3789	4032	4203	4436	4688	4910
N32JJWB	3302	3509	3689	3869	4058	4274	4427	4634	4859	5057
N32JJWBS	3432	3664	3866	4068	4280	4523	4694	4927	5179	5401
N32JJWL	2929	3136	3316	3496	3685	3901	4054	4261	4486	4684
N32JJWLS	3059	3291	3493	3695	3907	4150	4321	4554	4806	5028
N32JJWR	2929	3136	3316	3496	3685	3901	4054	4261	4486	4684
N32JJWRS	3059	3291	3493	3695	3907	4150	4321	4554	4806	5028
N32KCC	859	890	917	944	973	1005	1028	1059	1093	1123
N32KKM	667	698	725	752	781	813	836	867	901	931
N32KKW	785	816	843	870	899	931	954	985	1019	1049
N32LKM	1722	1795	1859	1923	1990	2067	2122	2195	2275	2346
N32LKW	1840	1913	1977	2041	2108	2185	2240	2313	2393	2464
N32LLM	2960	3165	3343	3521	3708	3921	4073	4277	4500	4696
N32LLMS	3079	3302	3496	3690	3893	4126	4291	4514	4757	4970

Model Number	Alliance Program Price Grades									
	K	L	M	N	O	P	Q	R	S	T
N32AAW	\$ 3015	\$ 3383	\$ 3603	\$ 3726	\$ 3843	\$ 3956	\$ 4073	\$ 4186	\$ 4304	\$ 4416
N32AAWS	3130	3505	3730	3855	3975	4090	4210	4325	4445	4560
N32BBM	3046	3414	3634	3757	3874	3987	4104	4217	4335	4447
N32BBMS	3130	3505	3730	3855	3975	4090	4210	4325	4445	4560
N32BBW	3164	3532	3752	3875	3992	4105	4222	4335	4453	4565
N32BBWS	3278	3653	3878	4003	4123	4238	4358	4473	4593	4708
N32CCML	3271	3639	3859	3982	4099	4212	4329	4442	4560	4672
N32CCMLS	3386	3761	3986	4111	4231	4346	4466	4581	4701	4816
N32CCMR	3271	3639	3859	3982	4099	4212	4329	4442	4560	4672
N32CCMRS	3386	3761	3986	4111	4231	4346	4466	4581	4701	4816
N32CCWL	3388	3756	3976	4099	4216	4329	4446	4559	4677	4789
N32CCWLS	3503	3878	4103	4228	4348	4463	4583	4698	4818	4933
N32CCWR	3388	3756	3976	4099	4216	4329	4446	4559	4677	4789
N32CCWRS	3503	3878	4103	4228	4348	4463	4583	4698	4818	4933
N32DDML	3406	3774	3994	4117	4234	4347	4464	4577	4695	4807
N32DDMLS	3520	3895	4120	4245	4365	4480	4600	4715	4835	4950
N32DDMR	3406	3774	3994	4117	4234	4347	4464	4577	4695	4807
N32DDMRS	3520	3895	4120	4245	4365	4480	4600	4715	4835	4950
N32DDWL	3522	3890	4110	4233	4350	4463	4580	4693	4811	4923
N32DDWLS	3638	4013	4238	4363	4483	4598	4718	4833	4953	5068
N32DDWR	3522	3890	4110	4233	4350	4463	4580	4693	4811	4923
N32DDWRS	3638	4013	4238	4363	4483	4598	4718	4833	4953	5068
N32HHM	4529	5204	5609	5834	6050	6257	6473	6680	6896	7103
N32HHMS	4914	5672	6126	6379	6621	6853	7096	7328	7570	7803
N32HHW	4647	5322	5727	5952	6168	6375	6591	6798	7014	7221
N32HHWS	5030	5788	6242	6495	6737	6969	7212	7444	7686	7919
N32HKM	2271	2526	2679	2764	2846	2924	3005	3084	3165	3243
N32HKW	2390	2645	2798	2883	2965	3043	3124	3203	3284	3362
N32JJMB	5273	5948	6353	6578	6794	7001	7217	7424	7640	7847
N32JJMBS	5657	6415	6869	7122	7364	7596	7839	8071	8313	8546
N32JJML	4901	5576	5981	6206	6422	6629	6845	7052	7268	7475
N32JJMLS	5284	6042	6496	6749	6991	7223	7466	7698	7940	8173
N32JJMR	4901	5576	5981	6206	6422	6629	6845	7052	7268	7475
N32JJMRS	5284	6042	6496	6749	6991	7223	7466	7698	7940	8173
N32JJWB	5390	6065	6470	6695	6911	7118	7334	7541	7757	7964
N32JJWBS	5775	6533	6987	7240	7482	7714	7957	8189	8431	8664
N32JJWL	5017	5692	6097	6322	6538	6745	6961	7168	7384	7591
N32JJWLS	5402	6160	6614	6867	7109	7341	7584	7816	8058	8291
N32JJWR	5017	5692	6097	6322	6538	6745	6961	7168	7384	7591
N32JJWRS	5402	6160	6614	6867	7109	7341	7584	7816	8058	8291
N32KKC	1173	1274	1335	1368	1401	1432	1464	1495	1528	1559
N32KKM	981	1082	1143	1176	1209	1240	1272	1303	1336	1367
N32KKW	1099	1200	1261	1294	1327	1358	1390	1421	1454	1485
N32LKM	2464	2704	2848	2928	3005	3078	3155	3229	3306	3379
N32LKW	2582	2822	2966	3046	3123	3196	3273	3347	3424	3497
N32LLM	5025	5693	6093	6316	6529	6734	6947	7152	7366	7570
N32LLMS	5329	6057	6493	6736	6968	7191	7424	7647	7880	8103

Alliance Program Pricing

Finishes

IM	Brighton	CW	Cordovan
NM	Natural	DW	Judicial
HN	Honey	MH	Mocha
CL	Caramel	405	Designer White
TF	Truffle	462	Cinder
AC	Autumn	792	Sable
MC	Amber	793	Acorn

To order, specify the following:

1. Chair Model Number
2. Fabric Grade Letter
3. Alliance Pattern Number and Color Number/Name
4. Finish Number (when applicable)

Sample Order Number

<u>N14KK</u>	<u>A</u>	<u>403901</u>	<u>036</u>	<u>HN</u>
Model Number	Fabric Grade Letter	Alliance Pattern Number	Alliance Color Number	Finish

Model Number

Alliance Program Price Grades

	A	B	C	D	E	F	G	H	I	J
N32LLW	\$ 3077	\$ 3282	\$ 3460	\$ 3638	\$ 3825	\$ 4038	\$ 4190	\$ 4394	\$ 4617	\$ 4813
N32LLWS	3196	3419	3613	3807	4010	4243	4408	4631	4874	5087
N32MAAM	1572	1637	1693	1749	1808	1875	1922	1987	2057	2118
N32MAAW	1689	1754	1810	1866	1925	1992	2039	2104	2174	2235
N32MBBM	1720	1785	1841	1897	1956	2023	2070	2135	2205	2266
N32MBBW	1837	1902	1958	2014	2073	2140	2187	2252	2322	2383
N32MHHM	2241	2393	2525	2657	2795	2954	3066	3218	3383	3528
N32MHHW	2358	2510	2642	2774	2912	3071	3183	3335	3500	3645
N32MLLM	2730	2861	2975	3089	3208	3345	3442	3573	3716	3841
N32MLLW	2847	2978	3092	3206	3325	3462	3559	3690	3833	3958
N32MMMB	3704	3909	4087	4265	4452	4665	4817	5021	5244	5440
N32MMMBBS	3824	4047	4241	4435	4638	4871	5036	5259	5502	5715
N32MMML	3332	3537	3715	3893	4080	4293	4445	4649	4872	5068
N32MMMLS	3451	3674	3868	4062	4265	4498	4663	4886	5129	5342
N32MMMR	3332	3537	3715	3893	4080	4293	4445	4649	4872	5068
N32MMMRS	3451	3674	3868	4062	4265	4498	4663	4886	5129	5342
N32MMWB	3822	4027	4205	4383	4570	4783	4935	5139	5362	5558
N32MMWBS	3940	4163	4357	4551	4754	4987	5152	5375	5618	5831
N32MMWL	3449	3654	3832	4010	4197	4410	4562	4766	4989	5185
N32MMWLS	3567	3790	3984	4178	4381	4614	4779	5002	5245	5458
N32MMWR	3449	3654	3832	4010	4197	4410	4562	4766	4989	5185
N32MMWRS	3567	3790	3984	4178	4381	4614	4779	5002	5245	5458
N32SAAM	1762	1875	1973	2071	2174	2291	2375	2487	2610	2718
N32SAAMS	1853	1968	2068	2168	2273	2393	2478	2593	2718	2828
N32SAAW	1878	1991	2089	2187	2290	2407	2491	2603	2726	2834
N32SAAWS	1970	2085	2185	2285	2390	2510	2595	2710	2835	2945
N32SBBM	1909	2022	2120	2218	2321	2438	2522	2634	2757	2865
N32SBBMS	1970	2085	2185	2285	2390	2510	2595	2710	2835	2945
N32SBBW	2027	2140	2238	2336	2439	2556	2640	2752	2875	2983
N32SBBWS	2118	2233	2333	2433	2538	2658	2743	2858	2983	3093
N32SCCML	2134	2247	2345	2443	2546	2663	2747	2859	2982	3090
N32SCCMLS	2226	2341	2441	2541	2646	2766	2851	2966	3091	3201
N32SCCMR	2134	2247	2345	2443	2546	2663	2747	2859	2982	3090
N32SCCMRS	2226	2341	2441	2541	2646	2766	2851	2966	3091	3201
N32SCCWL	2251	2364	2462	2560	2663	2780	2864	2976	3099	3207
N32SCCWLS	2343	2458	2558	2658	2763	2883	2968	3083	3208	3318
N32SCCWR	2251	2364	2462	2560	2663	2780	2864	2976	3099	3207
N32SCCWRS	2343	2458	2558	2658	2763	2883	2968	3083	3208	3318
N32SDDML	2269	2382	2480	2578	2681	2798	2882	2994	3117	3225
N32SDDMLS	2360	2475	2575	2675	2780	2900	2985	3100	3225	3335
N32SDDMR	2269	2382	2480	2578	2681	2798	2882	2994	3117	3225
N32SDDMRS	2360	2475	2575	2675	2780	2900	2985	3100	3225	3335
N32SDDWL	2385	2498	2596	2694	2797	2914	2998	3110	3233	3341
N32SDDWLS	2478	2593	2693	2793	2898	3018	3103	3218	3343	3453
N32SDDWR	2385	2498	2596	2694	2797	2914	2998	3110	3233	3341
N32SDDWRS	2478	2593	2693	2793	2898	3018	3103	3218	3343	3453
N32SHHM	2441	2648	2828	3008	3197	3413	3566	3773	3998	4196

Model Number	Alliance Program Price Grades									
	K	L	M	N	O	P	Q	R	S	T
N32LLW	\$ 5142	\$ 5810	\$ 6210	\$ 6433	\$ 6646	\$ 6851	\$ 7064	\$ 7269	\$ 7483	\$ 7687
N32LLWS	5446	6174	6610	6853	7085	7308	7541	7764	7997	8220
N32MAAM	2222	2432	2558	2628	2695	2760	2827	2891	2958	3023
N32MAAW	2339	2549	2675	2745	2812	2877	2944	3008	3075	3140
N32MBBM	2370	2580	2706	2776	2843	2908	2975	3039	3106	3171
N32MBBW	2487	2697	2823	2893	2960	3025	3092	3156	3223	3288
N32MHHM	3772	4267	4564	4729	4887	5039	5198	5349	5508	5660
N32MHHW	3889	4384	4681	4846	5004	5156	5315	5466	5625	5777
N32MLLM	4052	4480	4736	4879	5015	5146	5283	5414	5551	5682
N32MLLW	4169	4597	4853	4996	5132	5263	5400	5531	5668	5799
N32MMMB	5769	6437	6837	7060	7273	7478	7691	7896	8110	8314
N32MMMBS	6074	6802	7238	7481	7713	7936	8169	8392	8625	8848
N32MMML	5397	6065	6465	6688	6901	7106	7319	7524	7738	7942
N32MMMLS	5701	6429	6865	7108	7340	7563	7796	8019	8252	8475
N32MMMR	5397	6065	6465	6688	6901	7106	7319	7524	7738	7942
N32MMMRS	5701	6429	6865	7108	7340	7563	7796	8019	8252	8475
N32MMWB	5887	6555	6955	7178	7391	7596	7809	8014	8228	8432
N32MMWBS	6190	6918	7354	7597	7829	8052	8285	8508	8741	8964
N32MMWL	5514	6182	6582	6805	7018	7223	7436	7641	7855	8059
N32MMWLS	5817	6545	6981	7224	7456	7679	7912	8135	8368	8591
N32MMWR	5514	6182	6582	6805	7018	7223	7436	7641	7855	8059
N32MMWRS	5817	6545	6981	7224	7456	7679	7912	8135	8368	8591
N32SAAM	2899	3267	3487	3610	3727	3840	3957	4070	4188	4300
N32SAAMS	3013	3388	3613	3738	3858	3973	4093	4208	4328	4443
N32SAAW	3015	3383	3603	3726	3843	3956	4073	4186	4304	4416
N32SAAWS	3130	3505	3730	3855	3975	4090	4210	4325	4445	4560
N32SBBM	3046	3414	3634	3757	3874	3987	4104	4217	4335	4447
N32SBBMS	3130	3505	3730	3855	3975	4090	4210	4325	4445	4560
N32SBBW	3164	3532	3752	3875	3992	4105	4222	4335	4453	4565
N32SBBWS	3278	3653	3878	4003	4123	4238	4358	4473	4593	4708
N32SCCML	3271	3639	3859	3982	4099	4212	4329	4442	4560	4672
N32SCCMLS	3386	3761	3986	4111	4231	4346	4466	4581	4701	4816
N32SCCMR	3271	3639	3859	3982	4099	4212	4329	4442	4560	4672
N32SCCMRS	3386	3761	3986	4111	4231	4346	4466	4581	4701	4816
N32SCCWL	3388	3756	3976	4099	4216	4329	4446	4559	4677	4789
N32SCCWLS	3503	3878	4103	4228	4348	4463	4583	4698	4818	4933
N32SCCWR	3388	3756	3976	4099	4216	4329	4446	4559	4677	4789
N32SCCWRS	3503	3878	4103	4228	4348	4463	4583	4698	4818	4933
N32SDDML	3406	3774	3994	4117	4234	4347	4464	4577	4695	4807
N32SDDMLS	3520	3895	4120	4245	4365	4480	4600	4715	4835	4950
N32SDDMR	3406	3774	3994	4117	4234	4347	4464	4577	4695	4807
N32SDDMRS	3520	3895	4120	4245	4365	4480	4600	4715	4835	4950
N32SDDWL	3522	3890	4110	4233	4350	4463	4580	4693	4811	4923
N32SDDWLS	3638	4013	4238	4363	4483	4598	4718	4833	4953	5068
N32SDDWR	3522	3890	4110	4233	4350	4463	4580	4693	4811	4923
N32SDDWRS	3638	4013	4238	4363	4483	4598	4718	4833	4953	5068
N32SHHM	4529	5204	5609	5834	6050	6257	6473	6680	6896	7103

Alliance Program Pricing

Finishes

IM	Brighton	CW	Cordovan
NM	Natural	DW	Judicial
HN	Honey	MH	Mocha
CL	Caramel	405	Designer White
TF	Truffle	462	Cinder
AC	Autumn	792	Sable
MC	Amber	793	Acorn

To order, specify the following:

1. Chair Model Number
2. Fabric Grade Letter
3. Alliance Pattern Number and Color Number/Name
4. Finish Number (when applicable)

Sample Order Number

<u>N14KK</u>	<u>A</u>	<u>403901</u>	<u>036</u>	<u>HN</u>
Model Number	Fabric Grade Letter	Alliance Pattern Number	Alliance Color Number	Finish

Model Number

Alliance Program Price Grades

	A	B	C	D	E	F	G	H	I	J
N32SHHMS	\$ 2571	\$ 2803	\$ 3005	\$ 3207	\$ 3419	\$ 3662	\$ 3833	\$ 4066	\$ 4318	\$ 4540
N32SHHW	2559	2766	2946	3126	3315	3531	3684	3891	4116	4314
N32SHHWS	2687	2919	3121	3323	3535	3778	3949	4182	4434	4656
N32SJJMB	3185	3392	3572	3752	3941	4157	4310	4517	4742	4940
N32SJJMBS	3314	3546	3748	3950	4162	4405	4576	4809	5061	5283
N32SJJML	2813	3020	3200	3380	3569	3785	3938	4145	4370	4568
N32SJJMLS	2941	3173	3375	3577	3789	4032	4203	4436	4688	4910
N32SJJMR	2813	3020	3200	3380	3569	3785	3938	4145	4370	4568
N32SJJMRS	2941	3173	3375	3577	3789	4032	4203	4436	4688	4910
N32SJJWB	3302	3509	3689	3869	4058	4274	4427	4634	4859	5057
N32SJJWBS	3432	3664	3866	4068	4280	4523	4694	4927	5179	5401
N32SJJWL	2929	3136	3316	3496	3685	3901	4054	4261	4486	4684
N32SJJWLS	3059	3291	3493	3695	3907	4150	4321	4554	4806	5028
N32SJJWR	2929	3136	3316	3496	3685	3901	4054	4261	4486	4684
N32SJJWRS	3059	3291	3493	3695	3907	4150	4321	4554	4806	5028
N32SLLM	2960	3165	3343	3521	3708	3921	4073	4277	4500	4696
N32SLLMS	3079	3302	3496	3690	3893	4126	4291	4514	4757	4970
N32SLLW	3077	3282	3460	3638	3825	4038	4190	4394	4617	4813
N32SLLWS	3196	3419	3613	3807	4010	4243	4408	4631	4874	5087
N32SMAAM	1572	1637	1693	1749	1808	1875	1922	1987	2057	2118
N32SMAAW	1689	1754	1810	1866	1925	1992	2039	2104	2174	2235
N32SMBBM	1720	1785	1841	1897	1956	2023	2070	2135	2205	2266
N32SMBBW	1837	1902	1958	2014	2073	2140	2187	2252	2322	2383
N32SMHHM	2241	2393	2525	2657	2795	2954	3066	3218	3383	3528
N32SMHHW	2358	2510	2642	2774	2912	3071	3183	3335	3500	3645
N32SMLLM	2730	2861	2975	3089	3208	3345	3442	3573	3716	3841
N32SMLLW	2847	2978	3092	3206	3325	3462	3559	3690	3833	3958
N32SMMMB	3704	3909	4087	4265	4452	4665	4817	5021	5244	5440
N32SMMBBS	3824	4047	4241	4435	4638	4871	5036	5259	5502	5715
N32SMMML	3332	3537	3715	3893	4080	4293	4445	4649	4872	5068
N32SMMMLS	3451	3674	3868	4062	4265	4498	4663	4886	5129	5342
N32SMMMR	3332	3537	3715	3893	4080	4293	4445	4649	4872	5068
N32SMMMRS	3451	3674	3868	4062	4265	4498	4663	4886	5129	5342
N32SMMWB	3822	4027	4205	4383	4570	4783	4935	5139	5362	5558
N32SMMWBS	3940	4163	4357	4551	4754	4987	5152	5375	5618	5831
N32SMMWL	3449	3654	3832	4010	4197	4410	4562	4766	4989	5185
N32SMMWLS	3567	3790	3984	4178	4381	4614	4779	5002	5245	5458
N32SMMWR	3449	3654	3832	4010	4197	4410	4562	4766	4989	5185
N32SMMWRS	3567	3790	3984	4178	4381	4614	4779	5002	5245	5458
N32STA AW	2329	2394	2450	2506	2565	2632	2679	2744	2814	2875
N32STHHW	2998	3150	3282	3414	3552	3711	3823	3975	4140	4285
N32STLLW	3486	3617	3731	3845	3964	4101	4198	4329	4472	4597
N32TA AW	2329	2394	2450	2506	2565	2632	2679	2744	2814	2875
N32THHW	2998	3150	3282	3414	3552	3711	3823	3975	4140	4285
N32TLLW	3486	3617	3731	3845	3964	4101	4198	4329	4472	4597
N35AAC	775	798	818	838	859	883	900	923	948	970
N35AACS	872	895	915	935	956	980	997	1020	1045	1067

Model Number	Alliance Program Price Grades									
	K	L	M	N	O	P	Q	R	S	T
N32SHHMS	\$ 4914	\$ 5672	\$ 6126	\$ 6379	\$ 6621	\$ 6853	\$ 7096	\$ 7328	\$ 7570	\$ 7803
N32SHHW	4647	5322	5727	5952	6168	6375	6591	6798	7014	7221
N32SHHWS	5030	5788	6242	6495	6737	6969	7212	7444	7686	7919
N32SJJMB	5273	5948	6353	6578	6794	7001	7217	7424	7640	7847
N32SJJMBS	5657	6415	6869	7122	7364	7596	7839	8071	8313	8546
N32SJJML	4901	5576	5981	6206	6422	6629	6845	7052	7268	7475
N32SJJMLS	5284	6042	6496	6749	6991	7223	7466	7698	7940	8173
N32SJJMR	4901	5576	5981	6206	6422	6629	6845	7052	7268	7475
N32SJJMRS	5284	6042	6496	6749	6991	7223	7466	7698	7940	8173
N32SJJWB	5390	6065	6470	6695	6911	7118	7334	7541	7757	7964
N32SJJWBS	5775	6533	6987	7240	7482	7714	7957	8189	8431	8664
N32SJJWL	5017	5692	6097	6322	6538	6745	6961	7168	7384	7591
N32SJJWLS	5402	6160	6614	6867	7109	7341	7584	7816	8058	8291
N32SJJWR	5017	5692	6097	6322	6538	6745	6961	7168	7384	7591
N32SJJWRS	5402	6160	6614	6867	7109	7341	7584	7816	8058	8291
N32SLLM	5025	5693	6093	6316	6529	6734	6947	7152	7366	7570
N32SLLMS	5329	6057	6493	6736	6968	7191	7424	7647	7880	8103
N32SLLW	5142	5810	6210	6433	6646	6851	7064	7269	7483	7687
N32SLLWS	5446	6174	6610	6853	7085	7308	7541	7764	7997	8220
N32SMAAM	2222	2432	2558	2628	2695	2760	2827	2891	2958	3023
N32SMAAW	2339	2549	2675	2745	2812	2877	2944	3008	3075	3140
N32SMBBM	2370	2580	2706	2776	2843	2908	2975	3039	3106	3171
N32SMBBW	2487	2697	2823	2893	2960	3025	3092	3156	3223	3288
N32SMHHM	3772	4267	4564	4729	4887	5039	5198	5349	5508	5660
N32SMHHW	3889	4384	4681	4846	5004	5156	5315	5466	5625	5777
N32SMLLM	4052	4480	4736	4879	5015	5146	5283	5414	5551	5682
N32SMLLW	4169	4597	4853	4996	5132	5263	5400	5531	5668	5799
N32SMMMB	5769	6437	6837	7060	7273	7478	7691	7896	8110	8314
N32SMMMBS	6074	6802	7238	7481	7713	7936	8169	8392	8625	8848
N32SMMML	5397	6065	6465	6688	6901	7106	7319	7524	7738	7942
N32SMMMLS	5701	6429	6865	7108	7340	7563	7796	8019	8252	8475
N32SMMMR	5397	6065	6465	6688	6901	7106	7319	7524	7738	7942
N32SMMMRS	5701	6429	6865	7108	7340	7563	7796	8019	8252	8475
N32SMMWB	5887	6555	6955	7178	7391	7596	7809	8014	8228	8432
N32SMMWBS	6190	6918	7354	7597	7829	8052	8285	8508	8741	8964
N32SMMWL	5514	6182	6582	6805	7018	7223	7436	7641	7855	8059
N32SMMWLS	5817	6545	6981	7224	7456	7679	7912	8135	8368	8591
N32SMMWR	5514	6182	6582	6805	7018	7223	7436	7641	7855	8059
N32SMMWRS	5817	6545	6981	7224	7456	7679	7912	8135	8368	8591
N32STAAW	2979	3189	3315	3385	3452	3517	3584	3648	3715	3780
N32STHHW	4529	5024	5321	5486	5644	5796	5955	6106	6265	6417
N32STLLW	4808	5236	5492	5635	5771	5902	6039	6170	6307	6438
N32TAAW	2979	3189	3315	3385	3452	3517	3584	3648	3715	3780
N32THHW	4529	5024	5321	5486	5644	5796	5955	6106	6265	6417
N32TLLW	4808	5236	5492	5635	5771	5902	6039	6170	6307	6438
N35AAC	1007	1082	1127	1152	1176	1199	1223	1246	1270	1293
N35AACS	1104	1179	1224	1249	1273	1296	1320	1343	1367	1390

Alliance Program Pricing

Finishes

IM	Brighton	CW	Cordovan
NM	Natural	DW	Judicial
HN	Honey	MH	Mocha
CL	Caramel	405	Designer White
TF	Truffle	462	Cinder
AC	Autumn	792	Sable
MC	Amber	793	Acorn

To order, specify the following:

1. Chair Model Number
2. Fabric Grade Letter
3. Alliance Pattern Number and Color Number/Name
4. Finish Number (when applicable)

Sample Order Number

<u>N14KK</u>	<u>A</u>	<u>403901</u>	<u>036</u>	<u>HN</u>
Model Number	Fabric Grade Letter	Alliance Pattern Number	Alliance Color Number	Finish

Model Number

Alliance Program Price Grades

	A	B	C	D	E	F	G	H	I	J
N35ABC	\$ 830	\$ 869	\$ 903	\$ 937	\$ 972	\$ 1013	\$ 1042	\$ 1081	\$ 1124	\$ 1161
N35ABCS	927	966	1000	1034	1069	1110	1139	1178	1221	1258
N35ACC	918	941	961	981	1002	1026	1043	1066	1091	1113
N35ACCD	1030	1053	1073	1093	1114	1138	1155	1178	1203	1225
N35ACCDs	1128	1151	1171	1191	1212	1236	1253	1276	1301	1323
N35ACCS	1015	1038	1058	1078	1099	1123	1140	1163	1188	1210
N35AEC	974	1013	1047	1081	1116	1157	1186	1225	1268	1305
N35AECD	1087	1126	1160	1194	1229	1270	1299	1338	1381	1418
N35AECDs	1184	1223	1257	1291	1326	1367	1396	1435	1478	1515
N35AECS	1070	1109	1143	1177	1212	1253	1282	1321	1364	1401
N35AJC	1000	1023	1043	1063	1084	1108	1125	1148	1173	1195
N35AJCS	1096	1119	1139	1159	1180	1204	1221	1244	1269	1291
N35AMC	1055	1094	1128	1162	1197	1238	1267	1306	1349	1386
N35AMCS	1153	1192	1226	1260	1295	1336	1365	1404	1447	1484
N35AOC	1016	1041	1063	1085	1108	1135	1153	1179	1206	1230
N35AOCD	1129	1154	1176	1198	1221	1248	1266	1292	1319	1343
N35AOCDs	1217	1242	1264	1286	1309	1336	1354	1380	1407	1431
N35AOCS	1105	1130	1152	1174	1197	1224	1242	1268	1295	1319
N35APC	1067	1106	1140	1174	1209	1250	1279	1318	1361	1398
N35APCD	1180	1219	1253	1287	1322	1363	1392	1431	1474	1511
N35APCDs	1270	1309	1343	1377	1412	1453	1482	1521	1564	1601
N35APCS	1158	1197	1231	1265	1300	1341	1370	1409	1452	1489
N35ASC	1038	1063	1085	1107	1130	1157	1175	1201	1228	1252
N35ASCS	1129	1154	1176	1198	1221	1248	1266	1292	1319	1343
N35ATC	1090	1129	1163	1197	1232	1273	1302	1341	1384	1421
N35ATCS	1186	1225	1259	1293	1328	1369	1398	1437	1480	1517
N35BAC	682	705	725	745	766	790	807	830	855	877
N35BACS	779	802	822	842	863	887	904	927	952	974
N35BBC	740	779	813	847	882	923	952	991	1034	1071
N35BBCS	835	874	908	942	977	1018	1047	1086	1129	1166
N35BCC	826	849	869	889	910	934	951	974	999	1021
N35BCCD	938	961	981	1001	1022	1046	1063	1086	1111	1133
N35BCCDS	1034	1057	1077	1097	1118	1142	1159	1182	1207	1229
N35BCCS	922	945	965	985	1006	1030	1047	1070	1095	1117
N35BEC	882	921	955	989	1024	1065	1094	1133	1176	1213
N35BECD	995	1034	1068	1102	1137	1178	1207	1246	1289	1326
N35BECDs	1091	1130	1164	1198	1233	1274	1303	1342	1385	1422
N35BECS	979	1018	1052	1086	1121	1162	1191	1230	1273	1310
N35BJC	907	930	950	970	991	1015	1032	1055	1080	1102
N35BJCS	1004	1027	1047	1067	1088	1112	1129	1152	1177	1199
N35BMC	964	1003	1037	1071	1106	1147	1176	1215	1258	1295
N35BMCS	1060	1099	1133	1167	1202	1243	1272	1311	1354	1391
N35BOC	920	945	967	989	1012	1039	1057	1083	1110	1134
N35BOCD	1032	1057	1079	1101	1124	1151	1169	1195	1222	1246
N35BOCDs	1129	1154	1176	1198	1221	1248	1266	1292	1319	1343
N35BOCS	1016	1041	1063	1085	1108	1135	1153	1179	1206	1230
N35BPC	971	1010	1044	1078	1113	1154	1183	1222	1265	1302

Model Number	Alliance Program Price Grades									
	K	L	M	N	O	P	Q	R	S	T
N35ABC	\$ 1224	\$ 1352	\$ 1428	\$ 1471	\$ 1511	\$ 1550	\$ 1591	\$ 1630	\$ 1671	\$ 1710
N35ABCS	1321	1449	1525	1568	1608	1647	1688	1727	1768	1807
N35ACC	1150	1225	1270	1295	1319	1342	1366	1389	1413	1436
N35ACCD	1262	1337	1382	1407	1431	1454	1478	1501	1525	1548
N35ACCD S	1360	1435	1480	1505	1529	1552	1576	1599	1623	1646
N35ACCS	1247	1322	1367	1392	1416	1439	1463	1486	1510	1533
N35AEC	1368	1496	1572	1615	1655	1694	1735	1774	1815	1854
N35AECD	1481	1609	1685	1728	1768	1807	1848	1887	1928	1967
N35AECD S	1578	1706	1782	1825	1865	1904	1945	1984	2025	2064
N35AECS	1464	1592	1668	1711	1751	1790	1831	1870	1911	1950
N35AJC	1232	1307	1352	1377	1401	1424	1448	1471	1495	1518
N35AJCS	1328	1403	1448	1473	1497	1520	1544	1567	1591	1614
N35AMC	1449	1577	1653	1696	1736	1775	1816	1855	1896	1935
N35AMCS	1547	1675	1751	1794	1834	1873	1914	1953	1994	2033
N35AOC	1271	1354	1403	1431	1457	1482	1509	1534	1560	1586
N35AOCD	1384	1467	1516	1544	1570	1595	1622	1647	1673	1699
N35AOCD S	1472	1555	1604	1632	1658	1683	1710	1735	1761	1787
N35AOCS	1360	1443	1492	1520	1546	1571	1598	1623	1649	1675
N35APC	1461	1589	1665	1708	1748	1787	1828	1867	1908	1947
N35APCD	1574	1702	1778	1821	1861	1900	1941	1980	2021	2060
N35APCD S	1664	1792	1868	1911	1951	1990	2031	2070	2111	2150
N35APCS	1552	1680	1756	1799	1839	1878	1919	1958	1999	2038
N35ASC	1293	1376	1425	1453	1479	1504	1531	1556	1582	1608
N35ASCS	1384	1467	1516	1544	1570	1595	1622	1647	1673	1699
N35ATC	1484	1612	1688	1731	1771	1810	1851	1890	1931	1970
N35ATCS	1580	1708	1784	1827	1867	1906	1947	1986	2027	2066
N35BAC	914	989	1034	1059	1083	1106	1130	1153	1177	1200
N35BACS	1011	1086	1131	1156	1180	1203	1227	1250	1274	1297
N35BBC	1134	1262	1338	1381	1421	1460	1501	1540	1581	1620
N35BBCS	1229	1357	1433	1476	1516	1555	1596	1635	1676	1715
N35BCC	1058	1133	1178	1203	1227	1250	1274	1297	1321	1344
N35BCCD	1170	1245	1290	1315	1339	1362	1386	1409	1433	1456
N35BCCD S	1266	1341	1386	1411	1435	1458	1482	1505	1529	1552
N35BCCS	1154	1229	1274	1299	1323	1346	1370	1393	1417	1440
N35BEC	1276	1404	1480	1523	1563	1602	1643	1682	1723	1762
N35BECD	1389	1517	1593	1636	1676	1715	1756	1795	1836	1875
N35BECD S	1485	1613	1689	1732	1772	1811	1852	1891	1932	1971
N35BECS	1373	1501	1577	1620	1660	1699	1740	1779	1820	1859
N35BJC	1139	1214	1259	1284	1308	1331	1355	1378	1402	1425
N35BJCS	1236	1311	1356	1381	1405	1428	1452	1475	1499	1522
N35BMC	1358	1486	1562	1605	1645	1684	1725	1764	1805	1844
N35BMCS	1454	1582	1658	1701	1741	1780	1821	1860	1901	1940
N35BOC	1175	1258	1307	1335	1361	1386	1413	1438	1464	1490
N35BOCD	1287	1370	1419	1447	1473	1498	1525	1550	1576	1602
N35BOCD S	1384	1467	1516	1544	1570	1595	1622	1647	1673	1699
N35BOCS	1271	1354	1403	1431	1457	1482	1509	1534	1560	1586
N35BPC	1365	1493	1569	1612	1652	1691	1732	1771	1812	1851

Alliance Program Pricing

Finishes

IM	Brighton	CW	Cordovan
NM	Natural	DW	Judicial
HN	Honey	MH	Mocha
CL	Caramel	405	Designer White
TF	Truffle	462	Cinder
AC	Autumn	792	Sable
MC	Amber	793	Acorn

To order, specify the following:

1. Chair Model Number
2. Fabric Grade Letter
3. Alliance Pattern Number and Color Number/Name
4. Finish Number (when applicable)

Sample Order Number

<u>N14KK</u>	<u>A</u>	<u>403901</u>	<u>036</u>	<u>HN</u>
Model Number	Fabric Grade Letter	Alliance Pattern Number	Alliance Color Number	Finish

Model Number

Alliance Program Price Grades

	A	B	C	D	E	F	G	H	I	J
N35BPCD	\$ 1084	\$ 1123	\$ 1157	\$ 1191	\$ 1226	\$ 1267	\$ 1296	\$ 1335	\$ 1378	\$ 1415
N35BPCDS	1180	1219	1253	1287	1322	1363	1392	1431	1474	1511
N35BPCS	1067	1106	1140	1174	1209	1250	1279	1318	1361	1398
N35BSC	937	962	984	1006	1029	1056	1074	1100	1127	1151
N35BSCS	1038	1063	1085	1107	1130	1157	1175	1201	1228	1252
N35BTC	994	1033	1067	1101	1136	1177	1206	1245	1288	1325
N35BTCS	1089	1128	1162	1196	1231	1272	1301	1340	1383	1420
N35CAC	762	783	801	819	838	859	875	895	918	938
N35CBC	814	849	879	909	940	976	1002	1036	1074	1107
N35CCC	905	926	944	962	981	1002	1018	1038	1061	1081
N35CCCD	1018	1039	1057	1075	1094	1115	1131	1151	1174	1194
N35CEC	959	994	1024	1054	1085	1121	1147	1181	1219	1252
N35CECD	1072	1107	1137	1167	1198	1234	1260	1294	1332	1365
N35CJC	986	1007	1025	1043	1062	1083	1099	1119	1142	1162
N35CMC	1040	1075	1105	1135	1166	1202	1228	1262	1300	1333
N35COC	1003	1024	1042	1060	1079	1100	1116	1136	1159	1179
N35COCD	1117	1138	1156	1174	1193	1214	1230	1250	1273	1293
N35CPC	1055	1090	1120	1150	1181	1217	1243	1277	1315	1348
N35CPCD	1168	1203	1233	1263	1294	1330	1356	1390	1428	1461
N35CSC	1027	1048	1066	1084	1103	1124	1140	1160	1183	1203
N35CTC	1080	1115	1145	1175	1206	1242	1268	1302	1340	1373
N35EAC	866	887	905	923	942	963	979	999	1022	1042
N35EBC	919	954	984	1014	1045	1081	1107	1141	1179	1212
N35ECC	1017	1038	1056	1074	1093	1114	1130	1150	1173	1193
N35ECCD	1129	1150	1168	1186	1205	1226	1242	1262	1285	1305
N35EEC	1071	1106	1136	1166	1197	1233	1259	1293	1331	1364
N35EECD	1183	1218	1248	1278	1309	1345	1371	1405	1443	1476
N35JAC	1193	1218	1240	1262	1285	1312	1330	1356	1383	1407
N35JCC	1374	1399	1421	1443	1466	1493	1511	1537	1564	1588
N35MAC	1672	1732	1784	1836	1890	1953	1997	2057	2122	2179
N35MBC	1854	1914	1966	2018	2072	2135	2179	2239	2304	2361
39A-BWAA	1450	1494	1532	1570	1610	1655	1688	1731	1779	1821
39A-BWAAT	1535	1579	1617	1655	1695	1740	1773	1816	1864	1906
39A-GRXX	680	705	727	749	772	799	817	843	870	894
39A-GWXX	765	790	812	834	857	884	902	928	955	979
39A-GWXXT	851	876	898	920	943	970	988	1014	1041	1065
39A-TAA	1388	1430	1466	1502	1540	1583	1613	1655	1700	1739
39A-TAAA	2101	2163	2217	2271	2327	2392	2438	2500	2568	2627
39A-TAAAT	2273	2335	2389	2443	2499	2564	2610	2672	2740	2799
39A-TAAT	1520	1562	1598	1634	1672	1715	1745	1787	1832	1871
39B-GRXX	658	675	690	705	721	739	751	769	787	804
39B-GWXX	739	756	771	786	802	820	832	850	868	885
39B-GWXXT	827	846	862	878	895	914	927	946	966	983
39D-GRXX	666	683	698	713	729	747	759	777	795	812
39D-GWXX	751	768	783	798	814	832	844	862	880	897
39D-GWXXT	838	857	873	889	906	925	938	957	977	994
39E-GRXX	681	708	731	754	779	806	826	853	882	907

Model Number	Alliance Program Price Grades									
	K	L	M	N	O	P	Q	R	S	T
N35BPCD	\$ 1478	\$ 1606	\$ 1682	\$ 1725	\$ 1765	\$ 1804	\$ 1845	\$ 1884	\$ 1925	\$ 1964
N35BPCDS	1574	1702	1778	1821	1861	1900	1941	1980	2021	2060
N35BPCS	1461	1589	1665	1708	1748	1787	1828	1867	1908	1947
N35BSC	1192	1275	1324	1352	1378	1403	1430	1455	1481	1507
N35BSCS	1293	1376	1425	1453	1479	1504	1531	1556	1582	1608
N35BTC	1388	1516	1592	1635	1675	1714	1755	1794	1835	1874
N35BTCS	1483	1611	1687	1730	1770	1809	1850	1889	1930	1969
N35CAC	971	1039	1079	1102	1123	1144	1165	1186	1208	1228
N35CBC	1162	1275	1342	1380	1416	1450	1486	1521	1557	1591
N35CCC	1114	1182	1222	1245	1266	1287	1308	1329	1351	1371
N35CCCD	1227	1295	1335	1358	1379	1400	1421	1442	1464	1484
N35CEC	1307	1420	1487	1525	1561	1595	1631	1666	1702	1736
N35CECD	1420	1533	1600	1638	1674	1708	1744	1779	1815	1849
N35CJC	1195	1263	1303	1326	1347	1368	1389	1410	1432	1452
N35CMC	1388	1501	1568	1606	1642	1676	1712	1747	1783	1817
N35COC	1212	1280	1320	1343	1364	1385	1406	1427	1449	1469
N35COCD	1326	1394	1434	1457	1478	1499	1520	1541	1563	1583
N35CPC	1403	1516	1583	1621	1657	1691	1727	1762	1798	1832
N35CPCD	1516	1629	1696	1734	1770	1804	1840	1875	1911	1945
N35CSC	1236	1304	1344	1367	1388	1409	1430	1451	1473	1493
N35CTC	1428	1541	1608	1646	1682	1716	1752	1787	1823	1857
N35EAC	1075	1143	1183	1206	1227	1248	1269	1290	1312	1332
N35EBC	1267	1380	1447	1485	1521	1555	1591	1626	1662	1696
N35ECC	1226	1294	1334	1357	1378	1399	1420	1441	1463	1483
N35ECCD	1338	1406	1446	1469	1490	1511	1532	1553	1575	1595
N35EEC	1419	1532	1599	1637	1673	1707	1743	1778	1814	1848
N35EECD	1531	1644	1711	1749	1785	1819	1855	1890	1926	1960
N35JAC	1448	1531	1580	1608	1634	1659	1686	1711	1737	1763
N35JCC	1629	1712	1761	1789	1815	1840	1867	1892	1918	1944
N35MAC	2275	2470	2587	2652	2714	2774	2837	2896	2959	3019
N35MBC	2457	2652	2769	2834	2896	2956	3019	3078	3141	3201
39A-BWAA	1891	2034	2119	2167	2212	2256	2301	2345	2391	2434
39A-BWAAT	1976	2119	2204	2252	2297	2341	2386	2430	2476	2519
39A-GRXX	935	1018	1067	1095	1121	1146	1173	1198	1224	1250
39A-GWXX	1020	1103	1152	1180	1206	1231	1258	1283	1309	1335
39A-GWXXT	1106	1189	1238	1266	1292	1317	1344	1369	1395	1421
39A-TAA	1806	1941	2022	2067	2110	2152	2195	2236	2279	2321
39A-TAAA	2727	2930	3051	3119	3183	3245	3310	3372	3437	3499
39A-TAAAT	2899	3102	3223	3291	3355	3417	3482	3544	3609	3671
39A-TAAT	1938	2073	2154	2199	2242	2284	2327	2368	2411	2453
39B-GRXX	832	888	922	940	958	976	994	1011	1029	1046
39B-GWXX	913	969	1003	1021	1039	1057	1075	1092	1110	1127
39B-GWXXT	1013	1073	1109	1129	1148	1167	1186	1204	1223	1242
39D-GRXX	840	896	930	948	966	984	1002	1019	1037	1054
39D-GWXX	925	981	1015	1033	1051	1069	1087	1104	1122	1139
39D-GWXXT	1024	1084	1120	1140	1159	1178	1197	1215	1234	1253
39E-GRXX	950	1037	1089	1118	1146	1173	1201	1227	1255	1282

Alliance Program Pricing

Finishes

IM	Brighton	CW	Cordovan
NM	Natural	DW	Judicial
HN	Honey	MH	Mocha
CL	Caramel	405	Designer White
TF	Truffle	462	Cinder
AC	Autumn	792	Sable
MC	Amber	793	Acorn

To order, specify the following:

1. Chair Model Number
2. Fabric Grade Letter
3. Alliance Pattern Number and Color Number/Name
4. Finish Number (when applicable)

Sample Order Number

<u>N14KK</u>	<u>A</u>	<u>403901</u>	<u>036</u>	<u>HN</u>
Model Number	Fabric Grade Letter	Alliance Pattern Number	Alliance Color Number	Finish

Model Number

Alliance Program Price Grades

	A	B	C	D	E	F	G	H	I	J
39E-GWXX	\$ 766	\$ 793	\$ 816	\$ 839	\$ 864	\$ 891	\$ 911	\$ 938	\$ 967	\$ 992
39E-GWXXT	857	887	913	939	967	998	1020	1050	1082	1111
39H-GRXX	681	708	731	754	779	806	826	853	882	907
39H-GWXX	766	793	816	839	864	891	911	938	967	992
39H-GWXXT	835	851	865	879	893	910	922	938	956	971
39L-GRXX	658	675	690	705	721	739	751	769	787	804
39L-GWXX	739	756	771	786	802	820	832	850	868	885
39L-GWXXT	827	846	862	878	895	914	927	946	966	983
39S-GRXX	704	721	736	751	767	785	797	815	833	850
39S-GWXX	788	805	820	835	851	869	881	899	917	934
39S-GWXXT	874	893	909	925	942	961	974	993	1013	1030
39U-GRXX	691	718	741	764	789	816	836	863	892	917
39U-GWXX	773	800	823	846	871	898	918	945	974	999
39U-GWXXT	865	895	921	947	975	1006	1028	1058	1090	1119
N45AU	1275	1304	1330	1354	1380	1412	1432	1462	1494	1521
N45AUR	416	424	430	437	444	451	457	464	473	480
N45BU	1531	1560	1586	1610	1636	1668	1688	1718	1750	1777
N45BUR	501	509	515	522	529	536	542	549	558	565
N45CU	573	581	587	594	601	608	614	621	630	637
N45HU	706	714	720	727	734	741	747	754	763	770
N45HUL	597	605	611	618	625	632	638	645	654	661
N45JU	826	834	840	847	854	861	867	874	883	890
N45JUL	717	725	731	738	745	752	758	765	774	781
N45U1	395	403	409	416	423	430	436	443	452	459
N45U2	789	803	816	829	842	857	868	883	898	912
N45U3	1183	1205	1224	1243	1262	1285	1301	1323	1347	1367
48-EK, 48-EKN	1661	1728	1786	1844	1905	1974	2024	2090	2163	2227
48-EKJ, 48-EKNJ	1886	1953	2011	2069	2130	2199	2249	2315	2388	2452
48-ES, 48-ESN	1480	1556	1622	1688	1758	1837	1893	1969	2051	2124
48-ESJ, 48-ESNJ	1705	1781	1847	1913	1983	2062	2118	2194	2276	2349
48-GC, 48-GCN	1142	1209	1267	1325	1386	1455	1505	1571	1644	1708
N48GFA	1336	1375	1409	1443	1478	1519	1548	1587	1630	1667
N48GFM	1269	1308	1342	1376	1411	1452	1481	1520	1563	1600
N52GHA	660	679	695	711	728	747	760	779	799	816
N52GHAC	689	708	724	740	757	776	789	808	828	845
N52GHM	633	652	668	684	701	720	733	752	772	789
N52GHMC	660	679	695	711	728	747	760	779	799	816
N55AA	840	875	905	935	966	1002	1028	1062	1100	1133
N55BB	758	793	823	853	884	920	946	980	1018	1051
N55CC	827	842	855	869	883	898	910	925	941	956
N55DD	745	760	773	787	801	816	828	843	859	874
N55EE	773	796	816	836	857	881	898	921	946	968
N55HH	690	713	733	753	774	798	815	838	863	885
N59AA	941	962	980	998	1017	1038	1054	1074	1097	1117
N59AAT	1028	1049	1067	1085	1104	1125	1141	1161	1184	1204
N59AL	906	927	945	963	982	1003	1019	1039	1062	1082
N59BB	1004	1031	1055	1079	1104	1133	1154	1181	1211	1238

Model Number	Alliance Program Price Grades									
	K	L	M	N	O	P	Q	R	S	T
39E-GWXX	\$ 1035	\$ 1122	\$ 1174	\$ 1203	\$ 1231	\$ 1258	\$ 1286	\$ 1312	\$ 1340	\$ 1367
39E-GWXXT	1159	1257	1315	1348	1379	1409	1440	1470	1501	1531
39H-GRXX	950	1037	1089	1118	1146	1173	1201	1227	1255	1282
39H-GWXX	1035	1122	1174	1203	1231	1258	1286	1312	1340	1367
39H-GWXXT	997	1050	1081	1099	1115	1131	1148	1164	1181	1197
39L-GRXX	832	888	922	940	958	976	994	1011	1029	1046
39L-GWXX	913	969	1003	1021	1039	1057	1075	1092	1110	1127
39L-GWXXT	1013	1073	1109	1129	1148	1167	1186	1204	1223	1242
39S-GRXX	878	934	968	986	1004	1022	1040	1057	1075	1092
39S-GWXX	962	1018	1052	1070	1088	1106	1124	1141	1159	1176
39S-GWXXT	1060	1120	1156	1176	1195	1214	1233	1251	1270	1289
39U-GRXX	960	1047	1099	1128	1156	1183	1211	1237	1265	1292
39U-GWXX	1042	1129	1181	1210	1238	1265	1293	1319	1347	1374
39U-GWXXT	1167	1265	1323	1356	1387	1417	1448	1478	1509	1539
N45AU	1568	1663	1720	1751	1781	1811	1841	1869	1899	1929
N45AUR	492	516	531	539	547	554	562	569	577	585
N45BU	1824	1919	1976	2007	2037	2067	2097	2125	2155	2185
N45BUR	577	601	616	624	632	639	647	654	662	670
N45CU	649	673	688	696	704	711	719	726	734	742
N45HU	782	806	821	829	837	844	852	859	867	875
N45HUL	673	697	712	720	728	735	743	750	758	766
N45JU	902	926	941	949	957	964	972	979	987	995
N45JUL	793	817	832	840	848	855	863	870	878	886
N45U1	471	495	510	518	526	533	541	548	556	564
N45U2	935	983	1011	1027	1042	1057	1072	1086	1101	1116
N45U3	1402	1474	1517	1540	1562	1585	1607	1629	1651	1674
48-EK, 48-EKN	2334	2552	2682	2755	2824	2891	2960	3027	3097	3163
48-EKJ, 48-EKNJ	2559	2777	2907	2980	3049	3116	3185	3252	3322	3388
48-ES, 48-ESN	2246	2494	2642	2725	2804	2880	2959	3035	3114	3190
48-ESJ, 48-ESNJ	2471	2719	2867	2950	3029	3105	3184	3260	3339	3415
48-GC, 48-GCN	1815	2033	2163	2236	2305	2372	2441	2508	2578	2644
N48GFA	1730	1858	1934	1977	2017	2056	2097	2136	2177	2216
N48GFM	1663	1791	1867	1910	1950	1989	2030	2069	2110	2149
N52GHA	846	906	942	962	981	1000	1019	1037	1056	1075
N52GHAC	875	935	971	991	1010	1029	1048	1066	1085	1104
N52GHM	819	879	915	935	954	973	992	1010	1029	1048
N52GHMC	846	906	942	962	981	1000	1019	1037	1056	1075
N55AA	1188	1301	1368	1406	1442	1476	1512	1547	1583	1617
N55BB	1106	1219	1286	1324	1360	1394	1430	1465	1501	1535
N55CC	980	1030	1059	1076	1092	1107	1123	1138	1154	1169
N55DD	898	948	977	994	1010	1025	1041	1056	1072	1087
N55EE	1005	1080	1125	1150	1174	1197	1221	1244	1268	1291
N55HH	922	997	1042	1067	1091	1114	1138	1161	1185	1208
N59AA	1150	1218	1258	1281	1302	1323	1344	1365	1387	1407
N59AAT	1237	1305	1345	1368	1389	1410	1431	1452	1474	1494
N59AL	1115	1183	1223	1246	1267	1288	1309	1330	1352	1372
N59BB	1282	1372	1426	1456	1485	1512	1541	1569	1598	1625

Alliance Program Pricing

Finishes

IM	Brighton	CW	Cordovan
NM	Natural	DW	Judicial
HN	Honey	MH	Mocha
CL	Caramel	405	Designer White
TF	Truffle	462	Cinder
AC	Autumn	792	Sable
MC	Amber	793	Acorn

To order, specify the following:

1. Chair Model Number
2. Fabric Grade Letter
3. Alliance Pattern Number and Color Number/Name
4. Finish Number (when applicable)

Sample Order Number

<u>N14KK</u>	<u>A</u>	<u>403901</u>	<u>036</u>	<u>HN</u>
Model Number	Fabric Grade Letter	Alliance Pattern Number	Alliance Color Number	Finish

Model Number

Alliance Program Price Grades

	A	B	C	D	E	F	G	H	I	J
N59BBT	\$ 1089	\$ 1116	\$ 1140	\$ 1164	\$ 1189	\$ 1218	\$ 1239	\$ 1266	\$ 1296	\$ 1323
N59BL	970	997	1021	1045	1070	1099	1120	1147	1177	1204
N59CC	1010	1031	1049	1067	1086	1107	1123	1143	1166	1186
N59CCT	1097	1118	1136	1154	1173	1194	1210	1230	1253	1273
N59CL	975	996	1014	1032	1051	1072	1088	1108	1131	1151
N59DD	1033	1054	1072	1090	1109	1130	1146	1166	1189	1209
N59DDT	1118	1139	1157	1175	1194	1215	1231	1251	1274	1294
N59DL	999	1020	1038	1056	1075	1096	1112	1132	1155	1175
N59HH	1067	1088	1106	1124	1143	1164	1180	1200	1223	1243
N59HHT	1152	1173	1191	1209	1228	1249	1265	1285	1308	1328
N59HL	1033	1054	1072	1090	1109	1130	1146	1166	1189	1209
N59JJ	1092	1117	1139	1161	1184	1211	1229	1255	1282	1306
N59JJT	1179	1204	1226	1248	1271	1298	1316	1342	1369	1393
N59JL	1057	1082	1104	1126	1149	1176	1194	1220	1247	1271
N59KK	1680	1701	1719	1737	1756	1777	1793	1813	1836	1856
N59KKT	1767	1788	1806	1824	1843	1864	1880	1900	1923	1943
N59MM	1653	1688	1718	1748	1779	1815	1841	1875	1913	1946
N59MMT	1740	1775	1805	1835	1866	1902	1928	1962	2000	2033
N59PP	1736	1768	1796	1824	1854	1887	1911	1943	1978	2009
N59PPT	1822	1854	1882	1910	1940	1973	1997	2029	2064	2095
N60AA	373	394	412	430	449	470	486	506	529	549
N60AW	628	649	667	685	704	725	741	761	784	804
N60BB	346	367	385	403	422	443	459	479	502	522
N60BW	602	623	641	659	678	699	715	735	758	778
N60CC	436	459	479	499	520	544	561	584	609	631
N60CW	628	649	667	685	704	725	741	761	784	804
N60DD	408	431	451	471	492	516	533	556	581	603
N60DW	602	623	641	659	678	699	715	735	758	778
N60EE	1018	1055	1087	1119	1152	1191	1218	1255	1295	1330
N60EM	838	865	889	913	938	967	988	1015	1045	1072
N60EMW	1070	1089	1105	1121	1138	1157	1170	1189	1209	1226
N60EW	1255	1292	1324	1356	1389	1428	1455	1492	1532	1567
N60GG	1075	1112	1144	1176	1209	1248	1275	1312	1352	1387
N60GM	896	923	947	971	996	1025	1046	1073	1103	1130
N60GMW	1070	1089	1105	1121	1138	1157	1170	1189	1209	1226
N60GW	1255	1292	1324	1356	1389	1428	1455	1492	1532	1567
N60PM	838	865	889	913	938	967	988	1015	1045	1072
N60PMW	1070	1089	1105	1121	1138	1157	1170	1189	1209	1226
N60PP	1018	1055	1087	1119	1152	1191	1218	1255	1295	1330
N60PW	1255	1292	1324	1356	1389	1428	1455	1492	1532	1567
N60RM	896	923	947	971	996	1025	1046	1073	1103	1130
N60RMW	1070	1089	1105	1121	1138	1157	1170	1189	1209	1226
N60RR	1075	1112	1144	1176	1209	1248	1275	1312	1352	1387
N60RW	1255	1292	1324	1356	1389	1428	1455	1492	1532	1567
N60SAA	460	481	499	517	536	557	573	593	616	636
N60SAAC	432	453	471	489	508	529	545	565	588	608
N60SAW	716	737	755	773	792	813	829	849	872	892

Model Number	Alliance Program Price Grades									
	K	L	M	N	O	P	Q	R	S	T
N59BBT	\$ 1367	\$ 1457	\$ 1511	\$ 1541	\$ 1570	\$ 1597	\$ 1626	\$ 1654	\$ 1683	\$ 1710
N59BL	1248	1338	1392	1422	1451	1478	1507	1535	1564	1591
N59CC	1219	1287	1327	1350	1371	1392	1413	1434	1456	1476
N59CCT	1306	1374	1414	1437	1458	1479	1500	1521	1543	1563
N59CL	1184	1252	1292	1315	1336	1357	1378	1399	1421	1441
N59DD	1242	1310	1350	1373	1394	1415	1436	1457	1479	1499
N59DDT	1327	1395	1435	1458	1479	1500	1521	1542	1564	1584
N59DL	1208	1276	1316	1339	1360	1381	1402	1423	1445	1465
N59HH	1276	1344	1384	1407	1428	1449	1470	1491	1513	1533
N59HHT	1361	1429	1469	1492	1513	1534	1555	1576	1598	1618
N59HL	1242	1310	1350	1373	1394	1415	1436	1457	1479	1499
N59JJ	1347	1430	1479	1507	1533	1558	1585	1610	1636	1662
N59JJT	1434	1517	1566	1594	1620	1645	1672	1697	1723	1749
N59JL	1312	1395	1444	1472	1498	1523	1550	1575	1601	1627
N59KK	1889	1957	1997	2020	2041	2062	2083	2104	2126	2146
N59KKT	1976	2044	2084	2107	2128	2149	2170	2191	2213	2233
N59MM	2001	2114	2181	2219	2255	2289	2325	2360	2396	2430
N59MMT	2088	2201	2268	2306	2342	2376	2412	2447	2483	2517
N59PP	2061	2166	2229	2264	2298	2330	2363	2396	2429	2461
N59PPT	2147	2252	2315	2350	2384	2416	2449	2482	2515	2547
N60AA	582	650	690	713	734	755	776	797	819	839
N60AW	837	905	945	968	989	1010	1031	1052	1074	1094
N60BB	555	623	663	686	707	728	749	770	792	812
N60BW	811	879	919	942	963	984	1005	1026	1048	1068
N60CC	668	743	788	813	837	860	884	907	931	954
N60CW	837	905	945	968	989	1010	1031	1052	1074	1094
N60DD	640	715	760	785	809	832	856	879	903	926
N60DW	811	879	919	942	963	984	1005	1026	1048	1068
N60EE	1389	1509	1581	1621	1659	1696	1735	1771	1810	1847
N60EM	1116	1206	1260	1290	1319	1346	1375	1403	1432	1459
N60EMW	1256	1316	1352	1372	1391	1410	1429	1447	1466	1485
N60EW	1626	1746	1818	1858	1896	1933	1972	2008	2047	2084
N60GG	1446	1566	1638	1678	1716	1753	1792	1828	1867	1904
N60GM	1174	1264	1318	1348	1377	1404	1433	1461	1490	1517
N60GMW	1256	1316	1352	1372	1391	1410	1429	1447	1466	1485
N60GW	1626	1746	1818	1858	1896	1933	1972	2008	2047	2084
N60PM	1116	1206	1260	1290	1319	1346	1375	1403	1432	1459
N60PMW	1256	1316	1352	1372	1391	1410	1429	1447	1466	1485
N60PP	1389	1509	1581	1621	1659	1696	1735	1771	1810	1847
N60PW	1626	1746	1818	1858	1896	1933	1972	2008	2047	2084
N60RM	1174	1264	1318	1348	1377	1404	1433	1461	1490	1517
N60RMW	1256	1316	1352	1372	1391	1410	1429	1447	1466	1485
N60RR	1446	1566	1638	1678	1716	1753	1792	1828	1867	1904
N60RW	1626	1746	1818	1858	1896	1933	1972	2008	2047	2084
N60SAA	669	737	777	800	821	842	863	884	906	926
N60SAAC	641	709	749	772	793	814	835	856	878	898
N60SAW	925	993	1033	1056	1077	1098	1119	1140	1162	1182

Alliance Program Pricing

Finishes

IM	Brighton	CW	Cordovan
NM	Natural	DW	Judicial
HN	Honey	MH	Mocha
CL	Caramel	405	Designer White
TF	Truffle	462	Cinder
AC	Autumn	792	Sable
MC	Amber	793	Acorn

To order, specify the following:

1. Chair Model Number
2. Fabric Grade Letter
3. Alliance Pattern Number and Color Number/Name
4. Finish Number (when applicable)

Sample Order Number

<u>N14KK</u>	<u>A</u>	<u>403901</u>	<u>036</u>	<u>HN</u>
Model Number	Fabric Grade Letter	Alliance Pattern Number	Alliance Color Number	Finish

Model Number

Alliance Program Price Grades

	A	B	C	D	E	F	G	H	I	J
N60SAWC	\$ 686	\$ 707	\$ 725	\$ 743	\$ 762	\$ 783	\$ 799	\$ 819	\$ 842	\$ 862
N60SBB	433	454	472	490	509	530	546	566	589	609
N60SBBC	404	425	443	461	480	501	517	537	560	580
N60SBW	689	710	728	746	765	786	802	822	845	865
N60SBWC	660	681	699	717	736	757	773	793	816	836
N60SCC	523	546	566	586	607	631	648	671	696	718
N60SCCC	494	517	537	557	578	602	619	642	667	689
N60SCW	716	737	755	773	792	813	829	849	872	892
N60SCWC	686	707	725	743	762	783	799	819	842	862
N60SDD	496	519	539	559	580	604	621	644	669	691
N60SDDC	466	489	509	529	550	574	591	614	639	661
N60SDW	689	710	728	746	765	786	802	822	845	865
N60SDWC	660	681	699	717	736	757	773	793	816	836
N60SEE	1106	1143	1175	1207	1240	1279	1306	1343	1383	1418
N60SEEW	1341	1378	1410	1442	1475	1514	1541	1578	1618	1653
N60SEM	926	953	977	1001	1026	1055	1076	1103	1133	1160
N60SEMW	1158	1177	1193	1209	1226	1245	1258	1277	1297	1314
N60SFA	717	738	756	774	793	814	830	850	873	893
N60SFAW	965	986	1004	1022	1041	1062	1078	1098	1121	1141
N60SFB	691	712	730	748	767	788	804	824	847	867
N60SFBW	939	960	978	996	1015	1036	1052	1072	1095	1115
N60SFC	779	802	822	842	863	887	904	927	952	974
N60SFCW	965	986	1004	1022	1041	1062	1078	1098	1121	1141
N60SFD	753	776	796	816	837	861	878	901	926	948
N60SFDW	939	960	978	996	1015	1036	1052	1072	1095	1115
N60SGG	1161	1198	1230	1262	1295	1334	1361	1398	1438	1473
N60SGGW	1341	1378	1410	1442	1475	1514	1541	1578	1618	1653
N60SGM	984	1011	1035	1059	1084	1113	1134	1161	1191	1218
N60SGMW	1158	1177	1193	1209	1226	1245	1258	1277	1297	1314
N60SPM	926	953	977	1001	1026	1055	1076	1103	1133	1160
N60SPMW	1158	1177	1193	1209	1226	1245	1258	1277	1297	1314
N60SPP	1106	1143	1175	1207	1240	1279	1306	1343	1383	1418
N60SPPW	1341	1378	1410	1442	1475	1514	1541	1578	1618	1653
N60SRM	984	1011	1035	1059	1084	1113	1134	1161	1191	1218
N60SRMW	1158	1177	1193	1209	1226	1245	1258	1277	1297	1314
N60SRR	1161	1198	1230	1262	1295	1334	1361	1398	1438	1473
N60SRRW	1341	1378	1410	1442	1475	1514	1541	1578	1618	1653
N60STA	717	738	756	774	793	814	830	850	873	893
N60STAW	965	986	1004	1022	1041	1062	1078	1098	1121	1141
N60STB	691	712	730	748	767	788	804	824	847	867
N60STBW	939	960	978	996	1015	1036	1052	1072	1095	1115
N60STC	779	802	822	842	863	887	904	927	952	974
N60STCW	965	986	1004	1022	1041	1062	1078	1098	1121	1141
N60STD	753	776	796	816	837	861	878	901	926	948
N60STDW	939	960	978	996	1015	1036	1052	1072	1095	1115
62X-AUXX	2339	2546	2726	2906	3095	3311	3464	3671	3896	4094
62X-GUXX	841	890	933	976	1021	1073	1109	1159	1213	1260

Model Number	Alliance Program Price Grades									
	K	L	M	N	O	P	Q	R	S	T
N60SAWC	\$ 895	\$ 963	\$ 1003	\$ 1026	\$ 1047	\$ 1068	\$ 1089	\$ 1110	\$ 1132	\$ 1152
N60SBB	642	710	750	773	794	815	836	857	879	899
N60SBBC	613	681	721	744	765	786	807	828	850	870
N60SBW	898	966	1006	1029	1050	1071	1092	1113	1135	1155
N60SBWC	869	937	977	1000	1021	1042	1063	1084	1106	1126
N60SCC	755	830	875	900	924	947	971	994	1018	1041
N60SCCC	726	801	846	871	895	918	942	965	989	1012
N60SCW	925	993	1033	1056	1077	1098	1119	1140	1162	1182
N60SCWC	895	963	1003	1026	1047	1068	1089	1110	1132	1152
N60SDD	728	803	848	873	897	920	944	967	991	1014
N60SDDC	698	773	818	843	867	890	914	937	961	984
N60SDW	898	966	1006	1029	1050	1071	1092	1113	1135	1155
N60SDWC	869	937	977	1000	1021	1042	1063	1084	1106	1126
N60SEE	1477	1597	1669	1709	1747	1784	1823	1859	1898	1935
N60SEEW	1712	1832	1904	1944	1982	2019	2058	2094	2133	2170
N60SEM	1204	1294	1348	1378	1407	1434	1463	1491	1520	1547
N60SEMW	1344	1404	1440	1460	1479	1498	1517	1535	1554	1573
N60SFA	926	994	1034	1057	1078	1099	1120	1141	1163	1183
N60SFAW	1174	1242	1282	1305	1326	1347	1368	1389	1411	1431
N60SFB	900	968	1008	1031	1052	1073	1094	1115	1137	1157
N60SFBW	1148	1216	1256	1279	1300	1321	1342	1363	1385	1405
N60SFC	1011	1086	1131	1156	1180	1203	1227	1250	1274	1297
N60SFCW	1174	1242	1282	1305	1326	1347	1368	1389	1411	1431
N60SFD	985	1060	1105	1130	1154	1177	1201	1224	1248	1271
N60SFDW	1148	1216	1256	1279	1300	1321	1342	1363	1385	1405
N60SGG	1532	1652	1724	1764	1802	1839	1878	1914	1953	1990
N60SGGW	1712	1832	1904	1944	1982	2019	2058	2094	2133	2170
N60SGM	1262	1352	1406	1436	1465	1492	1521	1549	1578	1605
N60SGMW	1344	1404	1440	1460	1479	1498	1517	1535	1554	1573
N60SPM	1204	1294	1348	1378	1407	1434	1463	1491	1520	1547
N60SPMW	1344	1404	1440	1460	1479	1498	1517	1535	1554	1573
N60SPP	1477	1597	1669	1709	1747	1784	1823	1859	1898	1935
N60SPPW	1712	1832	1904	1944	1982	2019	2058	2094	2133	2170
N60SRM	1262	1352	1406	1436	1465	1492	1521	1549	1578	1605
N60SRMW	1344	1404	1440	1460	1479	1498	1517	1535	1554	1573
N60SRR	1532	1652	1724	1764	1802	1839	1878	1914	1953	1990
N60SRRW	1712	1832	1904	1944	1982	2019	2058	2094	2133	2170
N60STA	926	994	1034	1057	1078	1099	1120	1141	1163	1183
N60STAW	1174	1242	1282	1305	1326	1347	1368	1389	1411	1431
N60STB	900	968	1008	1031	1052	1073	1094	1115	1137	1157
N60STBW	1148	1216	1256	1279	1300	1321	1342	1363	1385	1405
N60STC	1011	1086	1131	1156	1180	1203	1227	1250	1274	1297
N60STCW	1174	1242	1282	1305	1326	1347	1368	1389	1411	1431
N60STD	985	1060	1105	1130	1154	1177	1201	1224	1248	1271
N60STDW	1148	1216	1256	1279	1300	1321	1342	1363	1385	1405
62X-AUXX	4427	5102	5507	5732	5948	6155	6371	6578	6794	7001
62X-GUXX	1340	1501	1598	1651	1703	1752	1804	1853	1905	1954

Alliance Program Pricing

Finishes

IM	Brighton	CW	Cordovan
NM	Natural	DW	Judicial
HN	Honey	MH	Mocha
CL	Caramel	405	Designer White
TF	Truffle	462	Cinder
AC	Autumn	792	Sable
MC	Amber	793	Acorn

To order, specify the following:

1. Chair Model Number
2. Fabric Grade Letter
3. Alliance Pattern Number and Color Number/Name
4. Finish Number (when applicable)

Sample Order Number

<u>N14KK</u>	<u>A</u>	<u>403901</u>	<u>036</u>	<u>HN</u>
Model Number	Fabric Grade Letter	Alliance Pattern Number	Alliance Color Number	Finish

Model Number

Alliance Program Price Grades

	A	B	C	D	E	F	G	H	I	J
62X-LUXX	\$ 1852	\$ 2004	\$ 2136	\$ 2268	\$ 2406	\$ 2565	\$ 2677	\$ 2829	\$ 2994	\$ 3139
62X-UUXX	1429	1544	1644	1744	1849	1969	2054	2169	2294	2404
64X-GWXX	797	828	855	882	911	944	967	998	1032	1062
N65AAA	1652	1696	1734	1772	1812	1857	1890	1933	1981	2023
N65AAP	1477	1521	1559	1597	1637	1682	1715	1758	1806	1848
N65AASA	1744	1788	1826	1864	1904	1949	1982	2025	2073	2115
N65AASP	1568	1612	1650	1688	1728	1773	1806	1849	1897	1939
N65BBA	1590	1632	1668	1704	1742	1785	1815	1857	1902	1941
N65BBP	1414	1456	1492	1528	1566	1609	1639	1681	1726	1765
N65BBSA	1681	1723	1759	1795	1833	1876	1906	1948	1993	2032
N65BBSP	1505	1547	1583	1619	1657	1700	1730	1772	1817	1856
N65CCA	1564	1608	1646	1684	1724	1769	1802	1845	1893	1935
N65CCP	1388	1432	1470	1508	1548	1593	1626	1669	1717	1759
N65CCSA	1655	1699	1737	1775	1815	1860	1893	1936	1984	2026
N65CCSP	1481	1525	1563	1601	1641	1686	1719	1762	1810	1852
N65DDA	1502	1544	1580	1616	1654	1697	1727	1769	1814	1853
N65DDP	1327	1369	1405	1441	1479	1522	1552	1594	1639	1678
N65DDSA	1593	1635	1671	1707	1745	1788	1818	1860	1905	1944
N65DDSP	1417	1459	1495	1531	1569	1612	1642	1684	1729	1768
N65EEA	1102	1125	1145	1165	1186	1210	1227	1250	1275	1297
N65EEP	998	1021	1041	1061	1082	1106	1123	1146	1171	1193
N65GGA	1157	1180	1200	1220	1241	1265	1282	1305	1330	1352
N65GGP	1052	1075	1095	1115	1136	1160	1177	1200	1225	1247
N65HHA										
N65HHP										
N66RD16C	526	551	573	595	618	645	663	689	716	740
N66RD16CX										
N66RD16G	506	531	553	575	598	625	643	669	696	720
N66RD16GX										
N66RD18C	575	603	626	650	675	704	724	751	781	807
N66RD18G	555	583	606	630	655	684	704	731	761	787
N66RD22C	622	652	678	704	732	763	786	816	848	877
N66RD22G	601	631	657	683	711	742	765	795	827	856
N66SQ18C	620	661	698	734	772	815	846	888	933	973
N66SQ16C	552	577	599	621	644	671	689	715	742	766
N66SQ16CX										
N66SQ16G	531	556	578	600	623	650	668	694	721	745
N66SQ16GX										
N66SQ18G	599	640	677	713	751	794	825	867	912	952
N66SQ22C	664	707	745	783	823	868	900	944	991	1032
N66SQ22G	644	687	725	763	803	848	880	924	971	1012
N66TZ16C	630	653	673	693	714	738	755	778	803	825
N66TZ16CX										
N66TZ16G	610	633	653	673	694	718	735	758	783	805
N66TZ16GX										
N66TZ18C	717	742	764	786	809	836	854	880	907	931
N66TZ18CX										

Model Number	Alliance Program Price Grades									
	K	L	M	N	O	P	Q	R	S	T
62X-LUXX	\$ 3383	\$ 3878	\$ 4175	\$ 4340	\$ 4498	\$ 4650	\$ 4809	\$ 4960	\$ 5119	\$ 5271
62X-UUXX	2589	2964	3189	3314	3434	3549	3669	3784	3904	4019
64X-GWXX	1112	1214	1275	1309	1342	1373	1406	1437	1470	1501
N65AAA	2093	2236	2321	2369	2414	2458	2503	2547	2593	2636
N65AAP	1918	2061	2146	2194	2239	2283	2328	2372	2418	2461
N65AASA	2185	2328	2413	2461	2506	2550	2595	2639	2685	2728
N65AASP	2009	2152	2237	2285	2330	2374	2419	2463	2509	2552
N65BBA	2008	2143	2224	2269	2312	2354	2397	2438	2481	2523
N65BBP	1832	1967	2048	2093	2136	2178	2221	2262	2305	2347
N65BBSA	2099	2234	2315	2360	2403	2445	2488	2529	2572	2614
N65BBSP	1923	2058	2139	2184	2227	2269	2312	2353	2396	2438
N65CCA	2005	2148	2233	2281	2326	2370	2415	2459	2505	2548
N65CCP	1829	1972	2057	2105	2150	2194	2239	2283	2329	2372
N65CCSA	2096	2239	2324	2372	2417	2461	2506	2550	2596	2639
N65CCSP	1922	2065	2150	2198	2243	2287	2332	2376	2422	2465
N65DDA	1920	2055	2136	2181	2224	2266	2309	2350	2393	2435
N65DDP	1745	1880	1961	2006	2049	2091	2134	2175	2218	2260
N65DDSA	2011	2146	2227	2272	2315	2357	2400	2441	2484	2526
N65DDSP	1835	1970	2051	2096	2139	2181	2224	2265	2308	2350
N65EEA	1334	1409	1454	1479	1503	1526	1550	1573	1597	1620
N65EEP	1230	1305	1350	1375	1399	1422	1446	1469	1493	1516
N65GGA	1389	1464	1509	1534	1558	1581	1605	1628	1652	1675
N65GGP	1284	1359	1404	1429	1453	1476	1500	1523	1547	1570
N65HHA										
N65HHP										
N66RD16C	781	864	913	941	967	992	1019	1044	1070	1096
N66RD16CX										
N66RD16G	761	844	893	921	947	972	999	1024	1050	1076
N66RD16GX										
N66RD18C	851	941	994	1024	1052	1080	1108	1136	1164	1192
N66RD18G	831	921	974	1004	1032	1060	1088	1116	1144	1172
N66RD22C	926	1024	1083	1116	1147	1177	1209	1239	1270	1300
N66RD22G	905	1003	1062	1095	1126	1156	1188	1218	1249	1279
N66SQ18C	1040	1175	1257	1302	1346	1387	1431	1472	1516	1557
N66SQ16C	807	890	939	967	993	1018	1045	1070	1096	1122
N66SQ16CX										
N66SQ16G	786	869	918	946	972	997	1024	1049	1075	1101
N66SQ16GX										
N66SQ18G	1019	1154	1236	1281	1325	1366	1410	1451	1495	1536
N66SQ22C	1102	1244	1329	1376	1422	1465	1511	1554	1599	1643
N66SQ22G	1082	1224	1309	1356	1402	1445	1491	1534	1579	1623
N66TZ16C	862	937	982	1007	1031	1054	1078	1101	1125	1148
N66TZ16CX										
N66TZ16G	842	917	962	987	1011	1034	1058	1081	1105	1128
N66TZ16GX										
N66TZ18C	972	1055	1104	1132	1158	1183	1210	1235	1261	1287
N66TZ18CX										

Alliance Program Pricing

Finishes

IM	Brighton	CW	Cordovan
NM	Natural	DW	Judicial
HN	Honey	MH	Mocha
CL	Caramel	405	Designer White
TF	Truffle	462	Cinder
AC	Autumn	792	Sable
MC	Amber	793	Acorn

To order, specify the following:

1. Chair Model Number
2. Fabric Grade Letter
3. Alliance Pattern Number and Color Number/Name
4. Finish Number (when applicable)

Sample Order Number

<u>N14KK</u>	<u>A</u>	<u>403901</u>	<u>036</u>	<u>HN</u>
Model Number	Fabric Grade Letter	Alliance Pattern Number	Alliance Color Number	Finish

Model Number

Alliance Program Price Grades

	A	B	C	D	E	F	G	H	I	J
N66TZ18G	\$ 696	\$ 721	\$ 743	\$ 765	\$ 788	\$ 815	\$ 833	\$ 859	\$ 886	\$ 910
N66TZ18GX										
N66TZ22C	769	801	829	857	887	920	944	976	1011	1042
N66TZ22CX										
N66TZ22G	748	780	808	836	866	899	923	955	990	1021
N66TZ22GX										
N67AAC										
N67BBC										
N67BBCJ										
N67CCC										
N67DDC										
N67DDCJ										
N67EE										
N68AAC										
N68BBC										
N68BBCJ										
N68CCC										
N68DDC										
N68DDCJ										
N68EE										
N69AAC										
N69BBC										
N69BBCJ										
N69CCC										
N69DDC										
N69DDCJ										
N69EE										
72X-GUXT	718	745	769	793	818	847	868	895	925	952
72X-GUXX	714	741	765	789	814	843	864	891	921	948
N75BAC	1022	1075	1121	1167	1216	1271	1310	1363	1420	1471
N75BBC	1201	1254	1300	1346	1395	1450	1489	1542	1599	1650
N75BCC	992	1042	1086	1130	1176	1229	1267	1317	1372	1421
N75BDC	1173	1223	1267	1311	1357	1410	1448	1498	1553	1602
N75SAC	1172	1225	1271	1317	1366	1421	1460	1513	1570	1621
N75SBC	1280	1333	1379	1425	1474	1529	1568	1621	1678	1729
N75SCC	1141	1191	1235	1279	1325	1378	1416	1466	1521	1570
N75SDC	1249	1299	1343	1387	1433	1486	1524	1574	1629	1678
N75SPC	1070	1120	1164	1208	1254	1307	1345	1395	1450	1499
N75SSC	1099	1152	1198	1244	1293	1348	1387	1440	1497	1548
N75WS	784	814	840	866	894	925	947	977	1009	1038
N78AFLAU	1238	1273	1303	1333	1364	1400	1426	1460	1498	1531
N78AFLAW	1374	1406	1434	1462	1492	1525	1549	1581	1616	1647
N78AFLMU	1154	1189	1219	1249	1280	1316	1342	1376	1414	1447
N78AFLMW	1291	1323	1351	1379	1409	1442	1466	1498	1533	1564
N78AFRAU	1238	1273	1303	1333	1364	1400	1426	1460	1498	1531
N78AFRAW	1374	1406	1434	1462	1492	1525	1549	1581	1616	1647
N78AFRMU	1154	1189	1219	1249	1280	1316	1342	1376	1414	1447

Model Number	Alliance Program Price Grades									
	K	L	M	N	O	P	Q	R	S	T
N66TZ18G	\$ 951	\$ 1034	\$ 1083	\$ 1111	\$ 1137	\$ 1162	\$ 1189	\$ 1214	\$ 1240	\$ 1266
N66TZ18GX										
N66TZ22C	1094	1199	1262	1297	1331	1363	1396	1429	1462	1494
N66TZ22CX										
N66TZ22G	1073	1178	1241	1276	1310	1342	1375	1408	1441	1473
N66TZ22GX										
N67AAC										
N67BBC										
N67BBCJ										
N67CCC										
N67DDC										
N67DDCJ										
N67EE										
N68AAC										
N68BBC										
N68BBCJ										
N68CCC										
N68DDC										
N68DDCJ										
N68EE										
N69AAC										
N69BBC										
N69BBCJ										
N69CCC										
N69DDC										
N69DDCJ										
N69EE										
72X-GUXT	996	1086	1140	1170	1199	1226	1255	1283	1312	1339
72X-GUXX	992	1082	1136	1166	1195	1222	1251	1279	1308	1335
N75BAC	1556	1729	1832	1890	1945	1998	2053	2106	2161	2214
N75BBC	1735	1908	2011	2069	2124	2177	2232	2285	2340	2393
N75BCC	1502	1667	1766	1821	1874	1924	1977	2028	2081	2131
N75BDC	1683	1848	1947	2002	2055	2105	2158	2209	2262	2312
N75SAC	1706	1879	1982	2040	2095	2148	2203	2256	2311	2364
N75SBC	1814	1987	2090	2148	2203	2256	2311	2364	2419	2472
N75SCC	1651	1816	1915	1970	2023	2073	2126	2177	2230	2280
N75SDC	1759	1924	2023	2078	2131	2181	2234	2285	2338	2388
N75SPC	1580	1745	1844	1899	1952	2002	2055	2106	2159	2209
N75SSC	1633	1806	1909	1967	2022	2075	2130	2183	2238	2291
N75WS	1086	1184	1242	1275	1306	1336	1367	1397	1428	1458
N78AFLAU	1586	1699	1766	1804	1840	1874	1910	1945	1981	2015
N78AFLAW	1699	1804	1867	1902	1936	1968	2001	2034	2067	2099
N78AFLMU	1502	1615	1682	1720	1756	1790	1826	1861	1897	1931
N78AFLMW	1616	1721	1784	1819	1853	1885	1918	1951	1984	2016
N78AFRAU	1586	1699	1766	1804	1840	1874	1910	1945	1981	2015
N78AFRAW	1699	1804	1867	1902	1936	1968	2001	2034	2067	2099
N78AFRMU	1502	1615	1682	1720	1756	1790	1826	1861	1897	1931

Alliance Program Pricing

Finishes

IM	Brighton	CW	Cordovan
NM	Natural	DW	Judicial
HN	Honey	MH	Mocha
CL	Caramel	405	Designer White
TF	Truffle	462	Cinder
AC	Autumn	792	Sable
MC	Amber	793	Acorn

To order, specify the following:

1. Chair Model Number
2. Fabric Grade Letter
3. Alliance Pattern Number and Color Number/Name
4. Finish Number (when applicable)

Sample Order Number

<u>N14KK</u>	<u>A</u>	<u>403901</u>	<u>036</u>	<u>HN</u>
Model Number	Fabric Grade Letter	Alliance Pattern Number	Alliance Color Number	Finish

Model Number

Alliance Program Price Grades

	A	B	C	D	E	F	G	H	I	J
N78AFRMW	\$ 1291	\$ 1323	\$ 1351	\$ 1379	\$ 1409	\$ 1442	\$ 1466	\$ 1498	\$ 1533	\$ 1564
N78B2AU	2582	2647	2703	2759	2818	2885	2932	2997	3067	3128
N78B2AW	2849	2904	2952	3000	3051	3108	3149	3204	3264	3317
N78B2EU	2525	2590	2646	2702	2761	2828	2875	2940	3010	3071
N78B2EW	2792	2847	2895	2943	2994	3051	3092	3147	3207	3260
N78B3AU	3814	3908	3990	4072	4158	4257	4326	4421	4523	4613
N78B3AW	4221	4306	4380	4454	4531	4620	4683	4768	4861	4942
N78B3EU	3758	3852	3934	4016	4102	4201	4270	4365	4467	4557
N78B3EW	4164	4249	4323	4397	4474	4563	4626	4711	4804	4885
N78D1M	971	996	1018	1040	1063	1090	1108	1134	1161	1185
N78D2A	1644	1686	1722	1758	1796	1839	1869	1911	1956	1995
N78D2M	1249	1291	1327	1363	1401	1444	1474	1516	1561	1600
N78D3A	2081	2131	2175	2219	2265	2318	2356	2406	2461	2510
N78D3M	1660	1710	1754	1798	1844	1897	1935	1985	2040	2089
N78GEAU	1965	2013	2055	2097	2141	2192	2227	2276	2328	2374
N78GEAW	2155	2199	2237	2275	2315	2360	2393	2436	2484	2526
N78GFAU	1266	1301	1331	1361	1392	1428	1454	1488	1526	1559
N78GFAW	1403	1435	1463	1491	1521	1554	1578	1610	1645	1676
N78GFMU	1183	1218	1248	1278	1309	1345	1371	1405	1443	1476
N78GFMW	1320	1352	1380	1408	1438	1471	1495	1527	1562	1593
N78LAAAU	4228	4403	4555	4707	4866	5049	5178	5353	5543	5710
N78LAAAUUB	4736	4911	5063	5215	5374	5557	5686	5861	6051	6218
N78LAAAUUL	4482	4657	4809	4961	5120	5303	5432	5607	5797	5964
N78LAAAUUR	4482	4657	4809	4961	5120	5303	5432	5607	5797	5964
N78LAAAW	4668	4843	4995	5147	5306	5489	5618	5793	5983	6150
N78LAAAWB	5173	5348	5500	5652	5811	5994	6123	6298	6488	6655
N78LAAAWL	4920	5095	5247	5399	5558	5741	5870	6045	6235	6402
N78LAAAWR	4920	5095	5247	5399	5558	5741	5870	6045	6235	6402
N78LAAU	3131	3255	3363	3471	3585	3714	3806	3930	4065	4184
N78LAAUB	3638	3762	3870	3978	4092	4221	4313	4437	4572	4691
N78LAAUL	3385	3509	3617	3725	3839	3968	4060	4184	4319	4438
N78LAAUR	3385	3509	3617	3725	3839	3968	4060	4184	4319	4438
N78LAAW	3402	3519	3621	3723	3830	3953	4039	4157	4284	4396
N78LAAWB	3908	4025	4127	4229	4336	4459	4545	4663	4790	4902
N78LAAWL	3655	3772	3874	3976	4083	4206	4292	4410	4537	4649
N78LAAWR	3655	3772	3874	3976	4083	4206	4292	4410	4537	4649
N78LAU	2092	2165	2229	2293	2360	2437	2492	2565	2645	2716
N78LAUL	2345	2418	2482	2546	2613	2690	2745	2818	2898	2969
N78LAUR	2345	2418	2482	2546	2613	2690	2745	2818	2898	2969
N78LAW	2224	2293	2353	2413	2476	2548	2599	2668	2743	2809
N78LAWL	2478	2547	2607	2667	2730	2802	2853	2922	2997	3063
N78LAWR	2478	2547	2607	2667	2730	2802	2853	2922	2997	3063
N78LBU	2739	2847	2941	3035	3133	3246	3326	3434	3552	3655
N78LBUB	3246	3354	3448	3542	3640	3753	3833	3941	4059	4162
N78LBUL	2993	3101	3195	3289	3387	3500	3580	3688	3806	3909
N78LBUR	2993	3101	3195	3289	3387	3500	3580	3688	3806	3909
N78LBW	3009	3110	3198	3286	3379	3484	3559	3660	3770	3867

Model Number	Alliance Program Price Grades									
	K	L	M	N	O	P	Q	R	S	T
N78AFRMW	\$ 1616	\$ 1721	\$ 1784	\$ 1819	\$ 1853	\$ 1885	\$ 1918	\$ 1951	\$ 1984	\$ 2016
N78B2AU	3232	3442	3568	3638	3705	3770	3837	3901	3968	4033
N78B2AW	3406	3586	3694	3754	3812	3867	3924	3980	4037	4092
N78B2EU	3175	3385	3511	3581	3648	3713	3780	3844	3911	3976
N78B2EW	3349	3529	3637	3697	3755	3810	3867	3923	3980	4035
N78B3AU	4765	5073	5257	5360	5458	5552	5651	5745	5843	5938
N78B3AW	5079	5357	5523	5616	5704	5789	5878	5963	6052	6137
N78B3EU	4709	5017	5201	5304	5402	5496	5595	5689	5787	5882
N78B3EW	5022	5300	5466	5559	5647	5732	5821	5906	5995	6080
N78D1M	1226	1309	1358	1386	1412	1437	1464	1489	1515	1541
N78D2A	2062	2197	2278	2323	2366	2408	2451	2492	2535	2577
N78D2M	1667	1802	1883	1928	1971	2013	2056	2097	2140	2182
N78D3A	2591	2756	2855	2910	2963	3013	3066	3117	3170	3220
N78D3M	2170	2335	2434	2489	2542	2592	2645	2696	2749	2799
N78GEAU	2452	2610	2704	2757	2807	2855	2906	2954	3004	3053
N78GEAW	2596	2739	2824	2872	2917	2961	3006	3050	3096	3139
N78GFAU	1614	1727	1794	1832	1868	1902	1938	1973	2009	2043
N78GFAW	1728	1833	1896	1931	1965	1997	2030	2063	2096	2128
N78GFMU	1531	1644	1711	1749	1785	1819	1855	1890	1926	1960
N78GFMW	1645	1750	1813	1848	1882	1914	1947	1980	2013	2045
N78LAAAU	5991	6561	6903	7093	7275	7450	7633	7807	7990	8165
N78LAAAUB	6499	7069	7411	7601	7783	7958	8141	8315	8498	8673
N78LAAAUL	6245	6815	7157	7347	7529	7704	7887	8061	8244	8419
N78LAAAUR	6245	6815	7157	7347	7529	7704	7887	8061	8244	8419
N78LAAAW	6431	7001	7343	7533	7715	7890	8073	8247	8430	8605
N78LAAAWB	6936	7506	7848	8038	8220	8395	8578	8752	8935	9110
N78LAAAWL	6683	7253	7595	7785	7967	8142	8325	8499	8682	8857
N78LAAAWR	6683	7253	7595	7785	7967	8142	8325	8499	8682	8857
N78LAAU	4384	4789	5032	5167	5297	5421	5550	5675	5804	5928
N78LAAUB	4891	5296	5539	5674	5804	5928	6057	6182	6311	6435
N78LAAUL	4638	5043	5286	5421	5551	5675	5804	5929	6058	6182
N78LAAUR	4638	5043	5286	5421	5551	5675	5804	5929	6058	6182
N78LAAW	4585	4968	5197	5325	5447	5564	5687	5804	5926	6044
N78LAAWB	5091	5474	5703	5831	5953	6070	6193	6310	6432	6550
N78LAAWL	4838	5221	5450	5578	5700	5817	5940	6057	6179	6297
N78LAAWR	4838	5221	5450	5578	5700	5817	5940	6057	6179	6297
N78LAU	2834	3074	3218	3298	3375	3448	3525	3599	3676	3749
N78LAUL	3087	3327	3471	3551	3628	3701	3778	3852	3929	4002
N78LAUR	3087	3327	3471	3551	3628	3701	3778	3852	3929	4002
N78LAW	2920	3145	3280	3355	3427	3496	3568	3637	3709	3778
N78LAWL	3174	3399	3534	3609	3681	3750	3822	3891	3963	4032
N78LAWR	3174	3399	3534	3609	3681	3750	3822	3891	3963	4032
N78LBU	3829	4182	4393	4511	4623	4731	4844	4952	5065	5173
N78LBUB	4336	4689	4900	5018	5130	5238	5351	5459	5572	5680
N78LBUL	4083	4436	4647	4765	4877	4985	5098	5206	5319	5427
N78LBUR	4083	4436	4647	4765	4877	4985	5098	5206	5319	5427
N78LBW	4030	4360	4558	4668	4774	4875	4980	5082	5187	5288

Alliance Program Pricing

Finishes

IM	Brighton	CW	Cordovan
NM	Natural	DW	Judicial
HN	Honey	MH	Mocha
CL	Caramel	405	Designer White
TF	Truffle	462	Cinder
AC	Autumn	792	Sable
MC	Amber	793	Acorn

To order, specify the following:

1. Chair Model Number
2. Fabric Grade Letter
3. Alliance Pattern Number and Color Number/Name
4. Finish Number (when applicable)

Sample Order Number

<u>N14KK</u>	<u>A</u>	<u>403901</u>	<u>036</u>	<u>HN</u>
Model Number	Fabric Grade Letter	Alliance Pattern Number	Alliance Color Number	Finish

Model Number

Alliance Program Price Grades

	A	B	C	D	E	F	G	H	I	J
N78LBWB	\$ 3516	\$ 3617	\$ 3705	\$ 3793	\$ 3886	\$ 3991	\$ 4066	\$ 4167	\$ 4277	\$ 4374
N78LBWL	3263	3364	3452	3540	3633	3738	3813	3914	4024	4121
N78LBWR	3263	3364	3452	3540	3633	3738	3813	3914	4024	4121
N78LCU	3451	3598	3726	3854	3989	4142	4251	4398	4558	4699
N78LCUB	3957	4104	4232	4360	4495	4648	4757	4904	5064	5205
N78LCUL	3704	3851	3979	4107	4242	4395	4504	4651	4811	4952
N78LCUR	3704	3851	3979	4107	4242	4395	4504	4651	4811	4952
N78LCW	3907	4047	4169	4291	4419	4566	4669	4810	4962	5096
N78LCWB	4413	4553	4675	4797	4925	5072	5175	5316	5468	5602
N78LCWL	4160	4300	4422	4544	4672	4819	4922	5063	5215	5349
N78LCWR	4160	4300	4422	4544	4672	4819	4922	5063	5215	5349
N78LEU	2351	2445	2527	2609	2695	2794	2863	2958	3060	3150
N78LEW	2537	2625	2701	2777	2857	2948	3012	3100	3195	3278
N78PAU	1476	1518	1554	1590	1628	1671	1701	1743	1788	1827
N78FAU	1378	1413	1443	1473	1504	1540	1566	1600	1638	1671
N78SFAW	1516	1548	1576	1604	1634	1667	1691	1723	1758	1789
N78SFMU	1295	1330	1360	1390	1421	1457	1483	1517	1555	1588
N78SFMW	1432	1464	1492	1520	1550	1583	1607	1639	1674	1705
N78T2AU	2553	2618	2674	2730	2789	2856	2903	2968	3038	3099
N78T2AW	2821	2876	2924	2972	3023	3080	3121	3176	3236	3289
N78T3AU	3787	3881	3963	4045	4131	4230	4299	4394	4496	4586
N78T3AW	4193	4278	4352	4426	4503	4592	4655	4740	4833	4914
N79AAC	968	1012	1050	1088	1128	1173	1206	1249	1297	1339
N79AACJ	1193	1237	1275	1313	1353	1398	1431	1474	1522	1564
N79BBC	930	969	1003	1037	1072	1113	1142	1181	1224	1261
N79BBCJ	1155	1194	1228	1262	1297	1338	1367	1406	1449	1486
N79CC	763	802	836	870	905	946	975	1014	1057	1094
N85CAC	1373	1412	1446	1480	1515	1556	1585	1624	1667	1704
N85CBC	1329	1366	1398	1430	1463	1502	1529	1566	1606	1641
N85LA	2157	2222	2278	2334	2393	2460	2507	2572	2642	2703
N85LAT	2274	2339	2395	2451	2510	2577	2624	2689	2759	2820
N85LB	2747	2840	2920	3001	3086	3182	3251	3344	3444	3533
N85LBT	2864	2957	3037	3118	3203	3299	3368	3461	3561	3650
N85LC	3397	3516	3620	3724	3833	3958	4047	4166	4296	4411
N85LCT	3515	3634	3738	3842	3951	4076	4165	4284	4414	4529
N85LD	1733	1791	1841	1891	1943	2003	2046	2103	2166	2221
N85LDT	1850	1908	1958	2008	2060	2120	2163	2220	2283	2338
N85SA	899	918	934	950	967	986	999	1018	1038	1055
N85SAA	1652	1689	1721	1753	1786	1825	1852	1889	1929	1964
N85SAAA	2482	2540	2590	2640	2692	2752	2795	2852	2915	2970
N85SAAAT	2654	2712	2762	2812	2864	2924	2967	3024	3087	3142
N85SAAT	1782	1819	1851	1883	1916	1955	1982	2019	2059	2094
N85SACA	2547	2602	2650	2698	2749	2806	2847	2902	2962	3015
N85SACAT	2719	2774	2822	2870	2921	2978	3019	3074	3134	3187
N85SAT	985	1004	1020	1036	1053	1072	1085	1104	1124	1141
N85SB	962	987	1009	1031	1054	1081	1099	1125	1152	1176
N85SBT	1047	1072	1094	1116	1139	1166	1184	1210	1237	1261

Model Number	Alliance Program Price Grades									
	K	L	M	N	O	P	Q	R	S	T
N78LBWB	\$ 4537	\$ 4867	\$ 5065	\$ 5175	\$ 5281	\$ 5382	\$ 5487	\$ 5589	\$ 5694	\$ 5795
N78LBWL	4284	4614	4812	4922	5028	5129	5234	5336	5441	5542
N78LBWR	4284	4614	4812	4922	5028	5129	5234	5336	5441	5542
N78LCU	4936	5416	5704	5864	6018	6165	6318	6466	6619	6766
N78LCUB	5442	5922	6210	6370	6524	6671	6824	6972	7125	7272
N78LCUL	5189	5669	5957	6117	6271	6418	6571	6719	6872	7019
N78LCUR	5189	5669	5957	6117	6271	6418	6571	6719	6872	7019
N78LCW	5322	5780	6054	6207	6353	6493	6640	6780	6926	7067
N78LCWB	5828	6286	6560	6713	6859	6999	7146	7286	7432	7573
N78LCWL	5575	6033	6307	6460	6606	6746	6893	7033	7179	7320
N78LCWR	5575	6033	6307	6460	6606	6746	6893	7033	7179	7320
N78LEU	3302	3610	3794	3897	3995	4089	4188	4282	4380	4475
N78LEW	3419	3704	3875	3970	4061	4149	4240	4327	4418	4506
N78PAU	1894	2029	2110	2155	2198	2240	2283	2324	2367	2409
N78FAU	1726	1839	1906	1944	1980	2014	2050	2085	2121	2155
N78FAW	1841	1946	2009	2044	2078	2110	2143	2176	2209	2241
N78FMU	1643	1756	1823	1861	1897	1931	1967	2002	2038	2072
N78FMW	1757	1862	1925	1960	1994	2026	2059	2092	2125	2157
N78T2AU	3203	3413	3539	3609	3676	3741	3808	3872	3939	4004
N78T2AW	3378	3558	3666	3726	3784	3839	3896	3952	4009	4064
N78T3AU	4738	5046	5230	5333	5431	5525	5624	5718	5816	5911
N78T3AW	5051	5329	5495	5588	5676	5761	5850	5935	6024	6109
N79AAC	1409	1552	1637	1685	1730	1774	1819	1863	1909	1952
N79AACJ	1634	1777	1862	1910	1955	1999	2044	2088	2134	2177
N79BBC	1324	1452	1528	1571	1611	1650	1691	1730	1771	1810
N79BBCJ	1549	1677	1753	1796	1836	1875	1916	1955	1996	2035
N79CC	1157	1285	1361	1404	1444	1483	1524	1563	1604	1643
N85CAC	1767	1895	1971	2014	2054	2093	2134	2173	2214	2253
N85CBC	1700	1820	1892	1932	1970	2007	2046	2082	2121	2158
N85LA	2807	3017	3143	3213	3280	3345	3412	3476	3543	3608
N85LAT	2924	3134	3260	3330	3397	3462	3529	3593	3660	3725
N85LB	3682	3984	4166	4266	4363	4456	4553	4645	4742	4835
N85LBT	3799	4101	4283	4383	4480	4573	4670	4762	4859	4952
N85LC	4603	4993	5227	5357	5482	5601	5726	5846	5971	6090
N85LCT	4721	5111	5345	5475	5600	5719	5844	5964	6089	6208
N85LD	2313	2501	2613	2676	2736	2793	2853	2911	2971	3028
N85LDT	2430	2618	2730	2793	2853	2910	2970	3028	3088	3145
N85SA	1085	1145	1181	1201	1220	1239	1258	1276	1295	1314
N85SAA	2023	2143	2215	2255	2293	2330	2369	2405	2444	2481
N85SAAA	3062	3250	3362	3425	3485	3542	3602	3660	3720	3777
N85SAAAT	3234	3422	3534	3597	3657	3714	3774	3832	3892	3949
N85SAAT	2153	2273	2345	2385	2423	2460	2499	2535	2574	2611
N85SACA	3104	3284	3392	3452	3510	3565	3622	3678	3735	3790
N85SACAT	3276	3456	3564	3624	3682	3737	3794	3850	3907	3962
N85SAT	1171	1231	1267	1287	1306	1325	1344	1362	1381	1400
N85SB	1217	1300	1349	1377	1403	1428	1455	1480	1506	1532
N85SBT	1302	1385	1434	1462	1488	1513	1540	1565	1591	1617

Alliance Program Pricing

Finishes

IM	Brighton	CW	Cordovan
NM	Natural	DW	Judicial
HN	Honey	MH	Mocha
CL	Caramel	405	Designer White
TF	Truffle	462	Cinder
AC	Autumn	792	Sable
MC	Amber	793	Acorn

To order, specify the following:

1. Chair Model Number
2. Fabric Grade Letter
3. Alliance Pattern Number and Color Number/Name
4. Finish Number (when applicable)

Sample Order Number

<u>N14KK</u>	<u>A</u>	<u>403901</u>	<u>036</u>	<u>HN</u>
Model Number	Fabric Grade Letter	Alliance Pattern Number	Alliance Color Number	Finish

Model Number

Alliance Program Price Grades

	A	B	C	D	E	F	G	H	I	J
N85SC	\$ 968	\$ 987	\$ 1003	\$ 1019	\$ 1036	\$ 1055	\$ 1068	\$ 1087	\$ 1107	\$ 1124
N85SCT	1055	1074	1090	1106	1123	1142	1155	1174	1194	1211
N85SE	1707	1751	1789	1827	1867	1912	1945	1988	2036	2078
N85SET	1794	1838	1876	1914	1954	1999	2032	2075	2123	2165
88X-ENFXC										
88X-ENFXCJ										
88X-GMXX										
88X-GRXX										
88X-MNFXC										
88X-MNFXCJ										
88X-MRFXC										
88X-MRFXCJ										
89X-EUEXC	1118	1167	1210	1253	1298	1350	1386	1436	1490	1537
89X-EUFXC	1039	1088	1131	1174	1219	1271	1307	1357	1411	1458
89X-EUFXCJ	1264	1313	1356	1399	1444	1496	1532	1582	1636	1683
89X-EWECC	1262	1304	1340	1376	1414	1457	1487	1529	1574	1613
89X-EWECCJ	1487	1529	1565	1601	1639	1682	1712	1754	1799	1838
89X-EWEXC	1202	1244	1280	1316	1354	1397	1427	1469	1514	1553
89X-EWEXCJ	1427	1469	1505	1541	1579	1622	1652	1694	1739	1778
89X-GWXX	799	834	864	894	925	961	987	1021	1059	1092
89X-MUEXC	1087	1133	1173	1213	1255	1303	1337	1383	1433	1477
89X-MUFXC	1008	1054	1094	1134	1176	1224	1258	1304	1354	1398
89X-MUFXCJ	1233	1279	1319	1359	1401	1449	1483	1529	1579	1623
89X-MWECC	1226	1263	1295	1327	1360	1399	1426	1463	1503	1538
89X-MWECCJ	1451	1488	1520	1552	1585	1624	1651	1688	1728	1763
89X-MWEXC	1166	1203	1235	1267	1300	1339	1366	1403	1443	1478
89X-MWEXCJ	1391	1428	1460	1492	1525	1564	1591	1628	1668	1703
N90AA	2104	2215	2311	2407	2508	2623	2704	2815	2935	3040
N90BB	2746	2937	3103	3269	3444	3643	3784	3975	4182	4365
N90CC	3343	3552	3734	3916	4107	4326	4480	4690	4917	5117
N92B1	1344	1406	1460	1514	1570	1635	1681	1743	1811	1870
N92B2	1806	1907	1995	2083	2176	2281	2356	2457	2567	2664
N92B3	2269	2409	2531	2653	2781	2928	3031	3172	3324	3458
N92B9	1908	1975	2033	2091	2152	2221	2271	2337	2410	2474
N92CSA	2175	2256	2326	2396	2469	2553	2613	2693	2781	2858
N92CSAC	2175	2256	2326	2396	2469	2553	2613	2693	2781	2858
N92CSAL	2414	2495	2565	2635	2708	2792	2852	2932	3020	3097
N92CSALC	2414	2495	2565	2635	2708	2792	2852	2932	3020	3097
N92CSAR	2414	2495	2565	2635	2708	2792	2852	2932	3020	3097
N92CSARC	2414	2495	2565	2635	2708	2792	2852	2932	3020	3097
N92CSLL	2146	2211	2267	2323	2382	2449	2496	2561	2631	2692
N92CSLLC	2146	2211	2267	2323	2382	2449	2496	2561	2631	2692
N92CSM	1656	1711	1759	1807	1858	1915	1956	2011	2071	2124
N92CSMC	1656	1711	1759	1807	1858	1915	1956	2011	2071	2124
N92CSR	2146	2211	2267	2323	2382	2449	2496	2561	2631	2692
N92CSRRC	2146	2211	2267	2323	2382	2449	2496	2561	2631	2692
N92H1B	2861	3038	3192	3346	3507	3692	3823	4000	4193	4362

Model Number	Alliance Program Price Grades									
	K	L	M	N	O	P	Q	R	S	T
N85SC	\$ 1154	\$ 1214	\$ 1250	\$ 1270	\$ 1289	\$ 1308	\$ 1327	\$ 1345	\$ 1364	\$ 1383
N85SCT	1241	1301	1337	1357	1376	1395	1414	1432	1451	1470
N85SE	2148	2291	2376	2424	2469	2513	2558	2602	2648	2691
N85SET	2235	2378	2463	2511	2556	2600	2645	2689	2735	2778
88X-ENFXC										
88X-ENFXCJ										
88X-GMXX										
88X-GRXX										
88X-MNFXC										
88X-MNFXCJ										
88X-MRFXC										
88X-MRFXCJ										
89X-EUEXC	1617	1778	1875	1928	1980	2029	2081	2130	2182	2231
89X-EUFXC	1538	1699	1796	1849	1901	1950	2002	2051	2103	2152
89X-EUFXCJ	1763	1924	2021	2074	2126	2175	2227	2276	2328	2377
89X-EWECC	1680	1815	1896	1941	1984	2026	2069	2110	2153	2195
89X-EWECCJ	1905	2040	2121	2166	2209	2251	2294	2335	2378	2420
89X-EWEXC	1620	1755	1836	1881	1924	1966	2009	2050	2093	2135
89X-EWEXCJ	1845	1980	2061	2106	2149	2191	2234	2275	2318	2360
89X-GWXX	1147	1260	1327	1365	1401	1435	1471	1506	1542	1576
89X-MUEXC	1551	1701	1791	1841	1889	1935	1983	2029	2077	2123
89X-MUFXC	1472	1622	1712	1762	1810	1856	1904	1950	1998	2044
89X-MUFXCJ	1697	1847	1937	1987	2035	2081	2129	2175	2223	2269
89X-MWECC	1597	1717	1789	1829	1867	1904	1943	1979	2018	2055
89X-MWECCJ	1822	1942	2014	2054	2092	2129	2168	2204	2243	2280
89X-MWEXC	1537	1657	1729	1769	1807	1844	1883	1919	1958	1995
89X-MWEXCJ	1762	1882	1954	1994	2032	2069	2108	2144	2183	2220
N90AA	3218	3578	3794	3914	4029	4140	4255	4365	4480	4591
N90BB	4672	5295	5668	5876	6075	6266	6465	6656	6855	7046
N90CC	5454	6137	6546	6774	6992	7201	7420	7629	7847	8057
N92B1	1970	2173	2294	2362	2426	2488	2553	2615	2680	2742
N92B2	2827	3157	3355	3465	3571	3672	3777	3879	3984	4085
N92B3	3684	4142	4416	4569	4715	4855	5002	5142	5288	5429
N92B9	2581	2799	2929	3002	3071	3138	3207	3274	3344	3410
N92CSA	2987	3250	3407	3495	3579	3659	3743	3824	3908	3988
N92CSAC	2987	3250	3407	3495	3579	3659	3743	3824	3908	3988
N92CSAL	3226	3489	3646	3734	3818	3898	3982	4063	4147	4227
N92CSALC	3226	3489	3646	3734	3818	3898	3982	4063	4147	4227
N92CSAR	3226	3489	3646	3734	3818	3898	3982	4063	4147	4227
N92CSARC	3226	3489	3646	3734	3818	3898	3982	4063	4147	4227
N92CSLL	2796	3006	3132	3202	3269	3334	3401	3465	3532	3597
N92CSLLC	2796	3006	3132	3202	3269	3334	3401	3465	3532	3597
N92CSM	2213	2393	2501	2561	2619	2674	2731	2787	2844	2899
N92CSMC	2213	2393	2501	2561	2619	2674	2731	2787	2844	2899
N92CSRR	2796	3006	3132	3202	3269	3334	3401	3465	3532	3597
N92CSRRC	2796	3006	3132	3202	3269	3334	3401	3465	3532	3597
N92H1B	4647	5225	5571	5764	5948	6125	6310	6487	6672	6849

Alliance Program Pricing

Finishes

IM	Brighton	CW	Cordovan
NM	Natural	DW	Judicial
HN	Honey	MH	Mocha
CL	Caramel	405	Designer White
TF	Truffle	462	Cinder
AC	Autumn	792	Sable
MC	Amber	793	Acorn

To order, specify the following:

1. Chair Model Number
2. Fabric Grade Letter
3. Alliance Pattern Number and Color Number/Name
4. Finish Number (when applicable)

Sample Order Number

<u>N14KK</u>	<u>A</u>	<u>403901</u>	<u>036</u>	<u>HN</u>
Model Number	Fabric Grade Letter	Alliance Pattern Number	Alliance Color Number	Finish

Model Number

Alliance Program Price Grades

	A	B	C	D	E	F	G	H	I	J
N92H1BH	\$ 3331	\$ 3575	\$ 3787	\$ 3999	\$ 4221	\$ 4476	\$ 4656	\$ 4900	\$ 5165	\$ 5398
N92H1BL	3099	3276	3430	3584	3745	3930	4061	4238	4431	4600
N92H1BM	3227	3438	3622	3806	3999	4220	4377	4588	4818	5021
N92H1BR	3099	3276	3430	3584	3745	3930	4061	4238	4431	4600
N92H1L	2568	2713	2839	2965	3098	3249	3356	3501	3658	3797
N92H1LH	2805	2985	3141	3297	3461	3648	3780	3960	4155	4326
N92H1LL	2807	2952	3078	3204	3337	3488	3595	3740	3897	4036
N92H1LM	2753	2916	3058	3200	3349	3520	3640	3804	3981	4137
N92H1M	2280	2395	2495	2595	2700	2820	2905	3020	3145	3255
N92H1R	2568	2713	2839	2965	3098	3249	3356	3501	3658	3797
N92H1RH	2805	2985	3141	3297	3461	3648	3780	3960	4155	4326
N92H1RM	2753	2916	3058	3200	3349	3520	3640	3804	3981	4137
N92H1RR	2807	2952	3078	3204	3337	3488	3595	3740	3897	4036
N92H2B	4251	4516	4746	4976	5217	5493	5689	5953	6241	6494
N92H2BB	4728	4993	5223	5453	5694	5970	6166	6430	6718	6971
N92H2BH	4726	5060	5350	5640	5944	6292	6539	6872	7235	7554
N92H2BL	4490	4755	4985	5215	5456	5732	5928	6192	6480	6733
N92H2BM	4621	4922	5184	5446	5721	6036	6258	6560	6887	7175
N92H2BR	4490	4755	4985	5215	5456	5732	5928	6192	6480	6733
N92H2L	3963	4197	4401	4605	4819	5064	5238	5472	5727	5952
N92H2LH	4200	4469	4703	4937	5182	5463	5662	5931	6224	6481
N92H2LL	4202	4436	4640	4844	5058	5303	5477	5711	5966	6191
N92H2LM	4148	4401	4621	4841	5072	5336	5523	5776	6051	6293
N92H2M	3674	3879	4057	4235	4422	4635	4787	4991	5214	5410
N92H2R	3963	4197	4401	4605	4819	5064	5238	5472	5727	5952
N92H2RH	4200	4469	4703	4937	5182	5463	5662	5931	6224	6481
N92H2RM	4148	4401	4621	4841	5072	5336	5523	5776	6051	6293
N92H2RR	4202	4436	4640	4844	5058	5303	5477	5711	5966	6191
N92H3B	5645	5999	6307	6615	6939	7308	7570	7924	8309	8648
N92H3BB	6123	6477	6785	7093	7417	7786	8048	8402	8787	9126
N92H3BH	6120	6543	6911	7279	7666	8107	8420	8843	9303	9708
N92H3BL	5884	6238	6546	6854	7178	7547	7809	8163	8548	8887
N92H3BM	6015	6406	6746	7086	7443	7851	8140	8531	8956	9330
N92H3BR	5884	6238	6546	6854	7178	7547	7809	8163	8548	8887
N92H3L	5357	5681	5963	6245	6541	6880	7119	7444	7796	8106
N92H3LH	5595	5954	6266	6578	6905	7280	7545	7904	8294	8637
N92H3LL	5596	5920	6202	6484	6780	7119	7358	7683	8035	8345
N92H3LM	5542	5885	6183	6481	6794	7151	7405	7747	8120	8448
N92H3M	5067	5359	5613	5867	6133	6438	6654	6946	7264	7543
N92H3R	5357	5681	5963	6245	6541	6880	7119	7444	7796	8106
N92H3RH	5595	5954	6266	6578	6905	7280	7545	7904	8294	8637
N92H3RM	5542	5885	6183	6481	6794	7151	7405	7747	8120	8448
N92H3RR	5596	5920	6202	6484	6780	7119	7358	7683	8035	8345
N92HC2	5732	5943	6127	6311	6504	6725	6882	7093	7323	7526
N92HC3	7976	8344	8664	8984	9320	9704	9976	10344	10744	11096
N92HIN9	3307	3449	3573	3697	3827	3976	4082	4224	4379	4516
N92HOU9	3261	3376	3476	3576	3681	3801	3886	4001	4126	4236

Model Number	Alliance Program Price Grades									
	K	L	M	N	O	P	Q	R	S	T
N92H1BH	\$ 5790	\$ 6585	\$ 7062	\$ 7327	\$ 7581	\$ 7825	\$ 8080	\$ 8323	\$ 8578	\$ 8822
N92H1BL	4885	5463	5809	6002	6186	6363	6548	6725	6910	7087
N92H1BM	5361	6051	6465	6695	6916	7127	7348	7560	7781	7992
N92H1BR	4885	5463	5809	6002	6186	6363	6548	6725	6910	7087
N92H1L	4030	4503	4786	4944	5095	5240	5391	5536	5687	5832
N92H1LH	4615	5200	5551	5746	5933	6113	6300	6479	6666	6846
N92H1LL	4269	4742	5025	5183	5334	5479	5630	5775	5926	6071
N92H1LM	4400	4933	5252	5430	5600	5763	5934	6097	6267	6431
N92H1M	3440	3815	4040	4165	4285	4400	4520	4635	4755	4870
N92H1R	4030	4503	4786	4944	5095	5240	5391	5536	5687	5832
N92H1RH	4615	5200	5551	5746	5933	6113	6300	6479	6666	6846
N92H1RM	4400	4933	5252	5430	5600	5763	5934	6097	6267	6431
N92H1RR	4269	4742	5025	5183	5334	5479	5630	5775	5926	6071
N92H2B	6919	7782	8299	8587	8863	9127	9403	9668	9944	10208
N92H2BB	7396	8259	8776	9064	9340	9604	9880	10145	10421	10685
N92H2BH	8090	9178	9830	10193	10541	10874	11222	11556	11904	12237
N92H2BL	7158	8021	8538	8826	9102	9366	9642	9907	10183	10447
N92H2BM	7660	8643	9232	9560	9874	10175	10490	10791	11105	11407
N92H2BR	7158	8021	8538	8826	9102	9366	9642	9907	10183	10447
N92H2L	6329	7094	7553	7808	8053	8287	8532	8767	9012	9246
N92H2LH	6914	7792	8318	8611	8891	9160	9441	9710	9991	10260
N92H2LL	6568	7333	7792	8047	8292	8526	8771	9006	9251	9485
N92H2LM	6700	7525	8020	8295	8559	8812	9076	9329	9593	9846
N92H2M	5739	6407	6807	7030	7243	7448	7661	7866	8080	8284
N92H2R	6329	7094	7553	7808	8053	8287	8532	8767	9012	9246
N92H2RH	6914	7792	8318	8611	8891	9160	9441	9710	9991	10260
N92H2RM	6700	7525	8020	8295	8559	8812	9076	9329	9593	9846
N92H2RR	6568	7333	7792	8047	8292	8526	8771	9006	9251	9485
N92H3B	9218	10373	11066	11451	11821	12175	12544	12899	13268	13622
N92H3BB	9696	10851	11544	11929	12299	12653	13022	13377	13746	14100
N92H3BH	10389	11769	12597	13057	13499	13922	14363	14787	15228	15651
N92H3BL	9457	10612	11305	11690	12060	12414	12783	13138	13507	13861
N92H3BM	9959	11234	11999	12424	12832	13223	13631	14022	14430	14821
N92H3BR	9457	10612	11305	11690	12060	12414	12783	13138	13507	13861
N92H3L	8628	9686	10320	10673	11011	11335	11674	11998	12336	12661
N92H3LH	9214	10384	11086	11476	11850	12209	12584	12942	13317	13676
N92H3LL	8867	9925	10559	10912	11250	11574	11913	12237	12575	12900
N92H3LM	8999	10117	10787	11160	11517	11860	12217	12560	12918	13260
N92H3M	8013	8966	9537	9855	10159	10451	10756	11048	11353	11645
N92H3R	8628	9686	10320	10673	11011	11335	11674	11998	12336	12661
N92H3RH	9214	10384	11086	11476	11850	12209	12584	12942	13317	13676
N92H3RM	8999	10117	10787	11160	11517	11860	12217	12560	12918	13260
N92H3RR	8867	9925	10559	10912	11250	11574	11913	12237	12575	12900
N92HC2	7866	8556	8970	9200	9421	9632	9853	10065	10286	10497
N92HC3	11688	12888	13608	14008	14392	14760	15144	15512	15896	16264
N92HIN9	4745	5210	5489	5644	5793	5935	6084	6227	6376	6518
N92HOU9	4421	4796	5021	5146	5266	5381	5501	5616	5736	5851

Alliance Program Pricing

Finishes

IM	Brighton	CW	Cordovan
NM	Natural	DW	Judicial
HN	Honey	MH	Mocha
CL	Caramel	405	Designer White
TF	Truffle	462	Cinder
AC	Autumn	792	Sable
MC	Amber	793	Acorn

To order, specify the following:

1. Chair Model Number
2. Fabric Grade Letter
3. Alliance Pattern Number and Color Number/Name
4. Finish Number (when applicable)

Sample Order Number

<u>N14KK</u>	<u>A</u>	<u>403901</u>	<u>036</u>	<u>HN</u>
Model Number	Fabric Grade Letter	Alliance Pattern Number	Alliance Color Number	Finish

Model Number

Alliance Program Price Grades

	A	B	C	D	E	F	G	H	I	J
N92HSQ9D	\$ 3042	\$ 3169	\$ 3279	\$ 3389	\$ 3504	\$ 3636	\$ 3730	\$ 3856	\$ 3994	\$ 4115
N92HSQ9L	3027	3144	3246	3348	3455	3578	3664	3782	3909	4021
N92HSQ9R	3027	3144	3246	3348	3455	3578	3664	3782	3909	4021
N92HTL2B	5793	5963	6111	6259	6415	6592	6718	6888	7073	7236
N92HTL2BB	6269	6439	6587	6735	6891	7068	7194	7364	7549	7712
N92HTL2BH	6339	6622	6868	7114	7373	7668	7877	8160	8467	8738
N92HTL2BL	6031	6201	6349	6497	6653	6830	6956	7126	7311	7474
N92HTL2BM	6235	6486	6704	6922	7151	7412	7598	7848	8121	8361
N92HTL2BR	6031	6201	6349	6497	6653	6830	6956	7126	7311	7474
N92HTL2L	5581	5767	5929	6091	6261	6456	6593	6780	6982	7160
N92HTL2LH	5814	6033	6223	6413	6612	6840	7002	7220	7458	7667
N92HTL2LL	5820	6006	6168	6330	6500	6695	6832	7019	7221	7399
N92HTL2LM	5761	5964	6140	6316	6501	6712	6861	7064	7284	7477
N92HTL2M	5289	5443	5577	5711	5851	6012	6126	6280	6448	6595
N92HTL2R	5581	5767	5929	6091	6261	6456	6593	6780	6982	7160
N92HTL2RH	5814	6033	6223	6413	6612	6840	7002	7220	7458	7667
N92HTL2RM	5761	5964	6140	6316	6501	6712	6861	7064	7284	7477
N92HTL2RR	5820	6006	6168	6330	6500	6695	6832	7019	7221	7399
N92HTL3B	7543	7826	8072	8318	8577	8872	9081	9364	9671	9942
N92HTL3BB	8021	8304	8550	8796	9055	9350	9559	9842	10149	10420
N92HTL3BH	8015	8364	8668	8972	9291	9656	9915	10264	10644	10979
N92HTL3BL	7782	8065	8311	8557	8816	9111	9320	9603	9910	10181
N92HTL3BM	7906	8221	8495	8769	9056	9385	9618	9933	10276	10577
N92HTL3BR	7782	8065	8311	8557	8816	9111	9320	9603	9910	10181
N92HTL3L	7251	7502	7720	7938	8167	8428	8614	8864	9137	9377
N92HTL3LH	7484	7767	8013	8259	8518	8813	9022	9305	9612	9883
N92HTL3LL	7490	7741	7959	8177	8406	8667	8853	9103	9376	9616
N92HTL3LM	7437	7706	7940	8174	8419	8700	8899	9168	9461	9718
N92HTL3M	6964	7185	7377	7569	7770	8001	8164	8385	8625	8836
N92HTL3R	7251	7502	7720	7938	8167	8428	8614	8864	9137	9377
N92HTL3RH	7484	7767	8013	8259	8518	8813	9022	9305	9612	9883
N92HTL3RM	7437	7706	7940	8174	8419	8700	8899	9168	9461	9718
N92HTL3RR	7490	7741	7959	8177	8406	8667	8853	9103	9376	9616
N92HTLC2	7224	7341	7443	7545	7652	7775	7861	7979	8106	8218
N92HTLC3	9686	9843	9979	10115	10258	10421	10536	10693	10863	11012
N92HTLIN9	4882	4981	5067	5153	5244	5347	5420	5519	5626	5721
N92HTLSQ9D	4606	4682	4748	4814	4884	4963	5019	5095	5177	5250
N92HTLSQ9L	4595	4664	4724	4784	4847	4919	4970	5039	5114	5180
N92HTLSQ9R	4595	4664	4724	4784	4847	4919	4970	5039	5114	5180
N92HTU2B	5100	5365	5595	5825	6066	6342	6538	6802	7090	7343
N92HTU2BB	5577	5842	6072	6302	6543	6819	7015	7279	7567	7820
N92HTU2BH	5574	5908	6198	6488	6792	7140	7387	7720	8083	8402
N92HTU2BL	5339	5604	5834	6064	6305	6581	6777	7041	7329	7582
N92HTU2BM	5470	5771	6033	6295	6570	6885	7107	7409	7736	8024
N92HTU2BR	5339	5604	5834	6064	6305	6581	6777	7041	7329	7582
N92HTU2L	4812	5046	5250	5454	5668	5913	6087	6321	6576	6801
N92HTU2LH	5049	5318	5552	5786	6031	6312	6511	6780	7073	7330

Model Number	Alliance Program Price Grades									
	K	L	M	N	O	P	Q	R	S	T
N92HSQ9D	\$ 4318	\$ 4731	\$ 4978	\$ 5116	\$ 5248	\$ 5374	\$ 5506	\$ 5633	\$ 5765	\$ 5891
N92HSQ9L	4210	4593	4822	4950	5072	5189	5312	5429	5551	5669
N92HSQ9R	4210	4593	4822	4950	5072	5189	5312	5429	5551	5669
N92HTL2B	7510	8065	8398	8583	8761	8931	9108	9279	9456	9626
N92HTL2BB	7986	8541	8874	9059	9237	9407	9584	9755	9932	10102
N92HTL2BH	9193	10116	10669	10977	11272	11555	11850	12133	12428	12711
N92HTL2BL	7748	8303	8636	8821	8999	9169	9346	9517	9694	9864
N92HTL2BM	8764	9582	10072	10345	10606	10857	11118	11369	11631	11881
N92HTL2BR	7748	8303	8636	8821	8999	9169	9346	9517	9694	9864
N92HTL2L	7460	8068	8432	8635	8829	9015	9210	9396	9590	9777
N92HTL2LH	8018	8731	9158	9396	9624	9842	10070	10289	10517	10735
N92HTL2LL	7699	8307	8671	8874	9068	9254	9449	9635	9829	10016
N92HTL2LM	7803	8463	8859	9079	9290	9493	9704	9906	10117	10320
N92HTL2M	6843	7346	7647	7815	7975	8129	8290	8444	8605	8759
N92HTL2R	7460	8068	8432	8635	8829	9015	9210	9396	9590	9777
N92HTL2RH	8018	8731	9158	9396	9624	9842	10070	10289	10517	10735
N92HTL2RM	7803	8463	8859	9079	9290	9493	9704	9906	10117	10320
N92HTL2RR	7699	8307	8671	8874	9068	9254	9449	9635	9829	10016
N92HTL3B	10397	11320	11873	12181	12476	12759	13054	13337	13632	13915
N92HTL3BB	10875	11798	12351	12659	12954	13237	13532	13815	14110	14393
N92HTL3BH	11541	12681	13365	13745	14110	14459	14824	15174	15539	15888
N92HTL3BL	10636	11559	12112	12420	12715	12998	13293	13576	13871	14154
N92HTL3BM	11084	12112	12728	13071	13399	13714	14043	14358	14687	15002
N92HTL3BR	10636	11559	12112	12420	12715	12998	13293	13576	13871	14154
N92HTL3L	9780	10598	11088	11361	11622	11873	12134	12385	12647	12897
N92HTL3LH	10338	11261	11814	12122	12417	12700	12995	13278	13573	13856
N92HTL3LL	10019	10837	11327	11600	11861	12112	12373	12624	12886	13136
N92HTL3LM	10151	11029	11555	11848	12128	12397	12678	12947	13228	13497
N92HTL3M	9191	9911	10343	10583	10813	11034	11265	11485	11716	11937
N92HTL3R	9780	10598	11088	11361	11622	11873	12134	12385	12647	12897
N92HTL3RH	10338	11261	11814	12122	12417	12700	12995	13278	13573	13856
N92HTL3RM	10151	11029	11555	11848	12128	12397	12678	12947	13228	13497
N92HTL3RR	10019	10837	11327	11600	11861	12112	12373	12624	12886	13136
N92HTLC2	8407	8790	9019	9147	9269	9386	9509	9626	9748	9866
N92HTLC3	11264	11774	12080	12250	12413	12570	12733	12889	13052	13209
N92HTLIN9	5880	6203	6396	6504	6607	6706	6809	6908	7011	7110
N92HTLSQ9D	5372	5620	5768	5851	5930	6006	6085	6161	6240	6316
N92HTLSQ9L	5291	5516	5651	5726	5798	5867	5939	6008	6080	6149
N92HTLSQ9R	5291	5516	5651	5726	5798	5867	5939	6008	6080	6149
N92HTU2B	7768	8631	9148	9436	9712	9976	10252	10517	10793	11057
N92HTU2BB	8245	9108	9625	9913	10189	10453	10729	10994	11270	11534
N92HTU2BH	8938	10026	10678	11041	11389	11722	12070	12404	12752	13085
N92HTU2BL	8007	8870	9387	9675	9951	10215	10491	10756	11032	11296
N92HTU2BM	8509	9492	10081	10409	10723	11024	11339	11640	11954	12256
N92HTU2BR	8007	8870	9387	9675	9951	10215	10491	10756	11032	11296
N92HTU2L	7178	7943	8402	8657	8902	9136	9381	9616	9861	10095
N92HTU2LH	7763	8641	9167	9460	9740	10009	10290	10559	10840	11109

Alliance Program Pricing

Finishes

IM	Brighton	CW	Cordovan
NM	Natural	DW	Judicial
HN	Honey	MH	Mocha
CL	Caramel	405	Designer White
TF	Truffle	462	Cinder
AC	Autumn	792	Sable
MC	Amber	793	Acorn

To order, specify the following:

1. Chair Model Number
2. Fabric Grade Letter
3. Alliance Pattern Number and Color Number/Name
4. Finish Number (when applicable)

Sample Order Number

<u>N14KK</u>	<u>A</u>	<u>403901</u>	<u>036</u>	<u>HN</u>
Model Number	Fabric Grade Letter	Alliance Pattern Number	Alliance Color Number	Finish

Model Number

Alliance Program Price Grades

	A	B	C	D	E	F	G	H	I	J
N92HTU2LL	\$ 5051	\$ 5285	\$ 5489	\$ 5693	\$ 5907	\$ 6152	\$ 6326	\$ 6560	\$ 6815	\$ 7040
N92HTU2LM	4996	5249	5469	5689	5920	6184	6371	6624	6899	7141
N92HTU2M	4523	4728	4906	5084	5271	5484	5636	5840	6063	6259
N92HTU2R	4812	5046	5250	5454	5668	5913	6087	6321	6576	6801
N92HTU2RH	5049	5318	5552	5786	6031	6312	6511	6780	7073	7330
N92HTU2RM	4996	5249	5469	5689	5920	6184	6371	6624	6899	7141
N92HTU2RR	5051	5285	5489	5693	5907	6152	6326	6560	6815	7040
N92HTU3B	6388	6742	7050	7358	7682	8051	8313	8667	9052	9391
N92HTU3BB	6866	7220	7528	7836	8160	8529	8791	9145	9530	9869
N92HTU3BH	6863	7286	7654	8022	8409	8850	9163	9586	10046	10451
N92HTU3BL	6627	6981	7289	7597	7921	8290	8552	8906	9291	9630
N92HTU3BM	6758	7149	7489	7829	8186	8594	8883	9274	9699	10073
N92HTU3BR	6627	6981	7289	7597	7921	8290	8552	8906	9291	9630
N92HTU3L	6100	6424	6706	6988	7284	7623	7862	8187	8539	8849
N92HTU3LH	6337	6696	7008	7320	7647	8022	8287	8646	9036	9379
N92HTU3LL	6339	6663	6945	7227	7523	7862	8101	8426	8778	9088
N92HTU3LM	6285	6628	6926	7224	7537	7894	8148	8490	8863	9191
N92HTU3M	5809	6101	6355	6609	6875	7180	7396	7688	8006	8285
N92HTU3R	6100	6424	6706	6988	7284	7623	7862	8187	8539	8849
N92HTU3RH	6337	6696	7008	7320	7647	8022	8287	8646	9036	9379
N92HTU3RM	6285	6628	6926	7224	7537	7894	8148	8490	8863	9191
N92HTU3RR	6339	6663	6945	7227	7523	7862	8101	8426	8778	9088
N92HTUC2	6556	6767	6951	7135	7328	7549	7706	7917	8147	8350
N92HTUC3	8800	9168	9488	9808	10144	10528	10800	11168	11568	11920
N92HTUIN9	4131	4273	4397	4521	4651	4800	4906	5048	5203	5340
N92HTUSQ9D	3866	3993	4103	4213	4328	4460	4554	4680	4818	4939
N92HTUSQ9L	3851	3968	4070	4172	4279	4402	4488	4606	4733	4845
N92HTUSQ9R	3851	3968	4070	4172	4279	4402	4488	4606	4733	4845
N92HTW2B	5793	5963	6111	6259	6415	6592	6718	6888	7073	7236
N92HTW2BB	6269	6439	6587	6735	6891	7068	7194	7364	7549	7712
N92HTW2BH	6339	6622	6868	7114	7373	7668	7877	8160	8467	8738
N92HTW2BL	6031	6201	6349	6497	6653	6830	6956	7126	7311	7474
N92HTW2BM	6235	6486	6704	6922	7151	7412	7598	7848	8121	8361
N92HTW2BR	6031	6201	6349	6497	6653	6830	6956	7126	7311	7474
N92HTW2L	5581	5767	5929	6091	6261	6456	6593	6780	6982	7160
N92HTW2LH	5814	6033	6223	6413	6612	6840	7002	7220	7458	7667
N92HTW2LL	5820	6006	6168	6330	6500	6695	6832	7019	7221	7399
N92HTW2LM	5761	5964	6140	6316	6501	6712	6861	7064	7284	7477
N92HTW2M	5289	5443	5577	5711	5851	6012	6126	6280	6448	6595
N92HTW2R	5581	5767	5929	6091	6261	6456	6593	6780	6982	7160
N92HTW2RH	5814	6033	6223	6413	6612	6840	7002	7220	7458	7667
N92HTW2RM	5761	5964	6140	6316	6501	6712	6861	7064	7284	7477
N92HTW2RR	5820	6006	6168	6330	6500	6695	6832	7019	7221	7399
N92HTW3B	7543	7826	8072	8318	8577	8872	9081	9364	9671	9942
N92HTW3BB	8021	8304	8550	8796	9055	9350	9559	9842	10149	10420
N92HTW3BH	8015	8364	8668	8972	9291	9656	9915	10264	10644	10979
N92HTW3BL	7782	8065	8311	8557	8816	9111	9320	9603	9910	10181

Model Number	Alliance Program Price Grades									
	K	L	M	N	O	P	Q	R	S	T
N92HTU2LL	\$ 7417	\$ 8182	\$ 8641	\$ 8896	\$ 9141	\$ 9375	\$ 9620	\$ 9855	\$ 10100	\$ 10334
N92HTU2LM	7548	8373	8868	9143	9407	9660	9924	10177	10441	10694
N92HTU2M	6588	7256	7656	7879	8092	8297	8510	8715	8929	9133
N92HTU2R	7178	7943	8402	8657	8902	9136	9381	9616	9861	10095
N92HTU2RH	7763	8641	9167	9460	9740	10009	10290	10559	10840	11109
N92HTU2RM	7548	8373	8868	9143	9407	9660	9924	10177	10441	10694
N92HTU2RR	7417	8182	8641	8896	9141	9375	9620	9855	10100	10334
N92HTU3B	9961	11116	11809	12194	12564	12918	13287	13642	14011	14365
N92HTU3BB	10439	11594	12287	12672	13042	13396	13765	14120	14489	14843
N92HTU3BH	11132	12512	13340	13800	14242	14665	15106	15530	15971	16394
N92HTU3BL	10200	11355	12048	12433	12803	13157	13526	13881	14250	14604
N92HTU3BM	10702	11977	12742	13167	13575	13966	14374	14765	15173	15564
N92HTU3BR	10200	11355	12048	12433	12803	13157	13526	13881	14250	14604
N92HTU3L	9371	10429	11063	11416	11754	12078	12417	12741	13079	13404
N92HTU3LH	9956	11126	11828	12218	12592	12951	13326	13684	14059	14418
N92HTU3LL	9610	10668	11302	11655	11993	12317	12656	12980	13318	13643
N92HTU3LM	9742	10860	11530	11903	12260	12603	12960	13303	13661	14003
N92HTU3M	8755	9708	10279	10597	10901	11193	11498	11790	12095	12387
N92HTU3R	9371	10429	11063	11416	11754	12078	12417	12741	13079	13404
N92HTU3RH	9956	11126	11828	12218	12592	12951	13326	13684	14059	14418
N92HTU3RM	9742	10860	11530	11903	12260	12603	12960	13303	13661	14003
N92HTU3RR	9610	10668	11302	11655	11993	12317	12656	12980	13318	13643
N92HTUC2	8690	9380	9794	10024	10245	10456	10677	10889	11110	11321
N92HTUC3	12512	13712	14432	14832	15216	15584	15968	16336	16720	17088
N92HTUIN9	5569	6034	6313	6468	6617	6759	6908	7051	7200	7342
N92HTUSQ9D	5142	5555	5802	5940	6072	6198	6330	6457	6589	6715
N92HTUSQ9L	5034	5417	5646	5774	5896	6013	6136	6253	6375	6493
N92HTUSQ9R	5034	5417	5646	5774	5896	6013	6136	6253	6375	6493
N92HTW2B	7510	8065	8398	8583	8761	8931	9108	9279	9456	9626
N92HTW2BB	7986	8541	8874	9059	9237	9407	9584	9755	9932	10102
N92HTW2BH	9193	10116	10669	10977	11272	11555	11850	12133	12428	12711
N92HTW2BL	7748	8303	8636	8821	8999	9169	9346	9517	9694	9864
N92HTW2BM	8764	9582	10072	10345	10606	10857	11118	11369	11631	11881
N92HTW2BR	7748	8303	8636	8821	8999	9169	9346	9517	9694	9864
N92HTW2L	7460	8068	8432	8635	8829	9015	9210	9396	9590	9777
N92HTW2LH	8018	8731	9158	9396	9624	9842	10070	10289	10517	10735
N92HTW2LL	7699	8307	8671	8874	9068	9254	9449	9635	9829	10016
N92HTW2LM	7803	8463	8859	9079	9290	9493	9704	9906	10117	10320
N92HTW2M	6843	7346	7647	7815	7975	8129	8290	8444	8605	8759
N92HTW2R	7460	8068	8432	8635	8829	9015	9210	9396	9590	9777
N92HTW2RH	8018	8731	9158	9396	9624	9842	10070	10289	10517	10735
N92HTW2RM	7803	8463	8859	9079	9290	9493	9704	9906	10117	10320
N92HTW2RR	7699	8307	8671	8874	9068	9254	9449	9635	9829	10016
N92HTW3B	10397	11320	11873	12181	12476	12759	13054	13337	13632	13915
N92HTW3BB	10875	11798	12351	12659	12954	13237	13532	13815	14110	14393
N92HTW3BH	11541	12681	13365	13745	14110	14459	14824	15174	15539	15888
N92HTW3BL	10636	11559	12112	12420	12715	12998	13293	13576	13871	14154

Alliance Program Pricing

Finishes

IM	Brighton	CW	Cordovan
NM	Natural	DW	Judicial
HN	Honey	MH	Mocha
CL	Caramel	405	Designer White
TF	Truffle	462	Cinder
AC	Autumn	792	Sable
MC	Amber	793	Acorn

To order, specify the following:

1. Chair Model Number
2. Fabric Grade Letter
3. Alliance Pattern Number and Color Number/Name
4. Finish Number (when applicable)

Sample Order Number

<u>N14KK</u>	<u>A</u>	<u>403901</u>	<u>036</u>	<u>HN</u>
Model Number	Fabric Grade Letter	Alliance Pattern Number	Alliance Color Number	Finish

Model Number

Alliance Program Price Grades

	A	B	C	D	E	F	G	H	I	J
N92HTW3BM	\$ 7906	\$ 8221	\$ 8495	\$ 8769	\$ 9056	\$ 9385	\$ 9618	\$ 9933	\$ 10276	\$ 10577
N92HTW3BR	7782	8065	8311	8557	8816	9111	9320	9603	9910	10181
N92HTW3L	7251	7502	7720	7938	8167	8428	8614	8864	9137	9377
N92HTW3LH	7484	7767	8013	8259	8518	8813	9022	9305	9612	9883
N92HTW3LM	7437	7706	7940	8174	8419	8700	8899	9168	9461	9718
N92HTW3LL	7490	7741	7959	8177	8406	8667	8853	9103	9376	9616
N92HTW3M	6964	7185	7377	7569	7770	8001	8164	8385	8625	8836
N92HTW3R	7251	7502	7720	7938	8167	8428	8614	8864	9137	9377
N92HTW3RH	7484	7767	8013	8259	8518	8813	9022	9305	9612	9883
N92HTW3RM	7437	7706	7940	8174	8419	8700	8899	9168	9461	9718
N92HTW3RR	7490	7741	7959	8177	8406	8667	8853	9103	9376	9616
N92HTWC2	7224	7341	7443	7545	7652	7775	7861	7979	8106	8218
N92HTWC3	9686	9843	9979	10115	10258	10421	10536	10693	10863	11012
N92HTWIN9	4882	4981	5067	5153	5244	5347	5420	5519	5626	5721
N92HTWSQ9D	4606	4682	4748	4814	4884	4963	5019	5095	5177	5250
N92HTWSQ9L	4595	4664	4724	4784	4847	4919	4970	5039	5114	5180
N92HTWSQ9R	4595	4664	4724	4784	4847	4919	4970	5039	5114	5180
N92M1B	2295	2452	2588	2724	2867	3030	3145	3302	3472	3621
N92M1BL	2533	2690	2826	2962	3105	3268	3383	3540	3710	3859
N92M1BM	2661	2852	3018	3184	3359	3558	3699	3890	4097	4280
N92M1BR	2533	2690	2826	2962	3105	3268	3383	3540	3710	3859
N92M1L	2007	2134	2244	2354	2469	2601	2695	2821	2959	3080
N92M1LL	2246	2373	2483	2593	2708	2840	2934	3060	3198	3319
N92M1LM	2189	2331	2455	2579	2709	2858	2964	3106	3261	3398
N92M1M	1715	1809	1891	1973	2059	2158	2227	2322	2424	2514
N92M1R	2007	2134	2244	2354	2469	2601	2695	2821	2959	3080
N92M1RM	2189	2331	2455	2579	2709	2858	2964	3106	3261	3398
N92M1RR	2246	2373	2483	2593	2708	2840	2934	3060	3198	3319
N92M2B	3125	3351	3547	3743	3949	4184	4350	4576	4821	5036
N92M2BB	3602	3828	4024	4220	4426	4661	4827	5053	5298	5513
N92M2BL	3364	3590	3786	3982	4188	4423	4589	4815	5060	5275
N92M2BM	3491	3751	3977	4203	4441	4712	4904	5164	5446	5695
N92M2BR	3364	3590	3786	3982	4188	4423	4589	4815	5060	5275
N92M2L	2833	3026	3194	3362	3539	3740	3883	4076	4286	4471
N92M2LL	3072	3265	3433	3601	3778	3979	4122	4315	4525	4710
N92M2LM	3019	3230	3414	3598	3791	4012	4169	4380	4610	4813
N92M2M	2545	2708	2850	2992	3141	3312	3432	3596	3773	3929
N92M2R	2833	3026	3194	3362	3539	3740	3883	4076	4286	4471
N92M2RM	3019	3230	3414	3598	3791	4012	4169	4380	4610	4813
N92M2RR	3072	3265	3433	3601	3778	3979	4122	4315	4525	4710
N92M3B	3955	4250	4506	4762	5031	5338	5555	5850	6170	6451
N92M3BB	4433	4728	4984	5240	5509	5816	6033	6328	6648	6929
N92M3BL	4194	4489	4745	5001	5270	5577	5794	6089	6409	6690
N92M3BM	4321	4650	4936	5222	5523	5866	6109	6438	6795	7110
N92M3BR	4194	4489	4745	5001	5270	5577	5794	6089	6409	6690
N92M3L	3667	3932	4162	4392	4633	4909	5105	5369	5657	5910
N92M3LL	3906	4171	4401	4631	4872	5148	5344	5608	5896	6149

Model Number	Alliance Program Price Grades									
	K	L	M	N	O	P	Q	R	S	T
N92HTW3BM	\$ 11084	\$ 12112	\$ 12728	\$ 13071	\$ 13399	\$ 13714	\$ 14043	\$ 14358	\$ 14687	\$ 15002
N92HTW3BR	10636	11559	12112	12420	12715	12998	13293	13576	13871	14154
N92HTW3L	9780	10598	11088	11361	11622	11873	12134	12385	12647	12897
N92HTW3LH	10338	11261	11814	12122	12417	12700	12995	13278	13573	13856
N92HTW3LM	10151	11029	11555	11848	12128	12397	12678	12947	13228	13497
N92HTW3LL	10019	10837	11327	11600	11861	12112	12373	12624	12886	13136
N92HTW3M	9191	9911	10343	10583	10813	11034	11265	11485	11716	11937
N92HTW3R	9780	10598	11088	11361	11622	11873	12134	12385	12647	12897
N92HTW3RH	10338	11261	11814	12122	12417	12700	12995	13278	13573	13856
N92HTW3RM	10151	11029	11555	11848	12128	12397	12678	12947	13228	13497
N92HTW3RR	10019	10837	11327	11600	11861	12112	12373	12624	12886	13136
N92HTWC2	8407	8790	9019	9147	9269	9386	9509	9626	9748	9866
N92HTWC3	11264	11774	12080	12250	12413	12570	12733	12889	13052	13209
N92HTWIN9	5880	6203	6396	6504	6607	6706	6809	6908	7011	7110
N92HTWSQ9D	5372	5620	5768	5851	5930	6006	6085	6161	6240	6316
N92HTWSQ9L	5291	5516	5651	5726	5798	5867	5939	6008	6080	6149
N92HTWSQ9R	5291	5516	5651	5726	5798	5867	5939	6008	6080	6149
N92M1B	3873	4383	4689	4859	5022	5179	5342	5498	5661	5818
N92M1BL	4111	4621	4927	5097	5260	5417	5580	5736	5899	6056
N92M1BM	4587	5210	5583	5791	5990	6181	6380	6571	6770	6961
N92M1BR	4111	4621	4927	5097	5260	5417	5580	5736	5899	6056
N92M1L	3283	3696	3943	4081	4213	4339	4471	4598	4730	4856
N92M1LL	3522	3935	4182	4320	4452	4578	4710	4837	4969	5095
N92M1LM	3627	4092	4371	4526	4675	4817	4966	5109	5258	5400
N92M1M	2666	2974	3158	3261	3359	3453	3552	3646	3744	3839
N92M1R	3283	3696	3943	4081	4213	4339	4471	4598	4730	4856
N92M1RM	3627	4092	4371	4526	4675	4817	4966	5109	5258	5400
N92M1RR	3522	3935	4182	4320	4452	4578	4710	4837	4969	5095
N92M2B	5399	6134	6575	6820	7055	7281	7516	7741	7976	8202
N92M2BB	5876	6611	7052	7297	7532	7758	7993	8218	8453	8679
N92M2BL	5638	6373	6814	7059	7294	7520	7755	7980	8215	8441
N92M2BM	6113	6961	7469	7752	8023	8283	8554	8814	9085	9345
N92M2BR	5638	6373	6814	7059	7294	7520	7755	7980	8215	8441
N92M2L	4782	5412	5790	6000	6202	6395	6596	6790	6991	7184
N92M2LL	5021	5651	6029	6239	6441	6634	6835	7029	7230	7423
N92M2LM	5153	5843	6257	6487	6708	6919	7140	7352	7573	7784
N92M2M	4192	4725	5044	5222	5392	5555	5726	5889	6059	6223
N92M2R	4782	5412	5790	6000	6202	6395	6596	6790	6991	7184
N92M2RM	5153	5843	6257	6487	6708	6919	7140	7352	7573	7784
N92M2RR	5021	5651	6029	6239	6441	6634	6835	7029	7230	7423
N92M3B	6925	7885	8461	8781	9088	9383	9690	9984	10291	10586
N92M3BB	7403	8363	8939	9259	9566	9861	10168	10462	10769	11064
N92M3BL	7164	8124	8700	9020	9327	9622	9929	10223	10530	10825
N92M3BM	7639	8712	9355	9713	10056	10385	10728	11057	11400	11729
N92M3BR	7164	8124	8700	9020	9327	9622	9929	10223	10530	10825
N92M3L	6335	7198	7715	8003	8279	8543	8819	9084	9360	9624
N92M3LL	6574	7437	7954	8242	8518	8782	9058	9323	9599	9863

Alliance Program Pricing

Finishes

IM	Brighton	CW	Cordovan
NM	Natural	DW	Judicial
HN	Honey	MH	Mocha
CL	Caramel	405	Designer White
TF	Truffle	462	Cinder
AC	Autumn	792	Sable
MC	Amber	793	Acorn

To order, specify the following:

1. Chair Model Number
2. Fabric Grade Letter
3. Alliance Pattern Number and Color Number/Name
4. Finish Number (when applicable)

Sample Order Number

<u>N14KK</u>	<u>A</u>	<u>403901</u>	<u>036</u>	<u>HN</u>
Model Number	Fabric Grade Letter	Alliance Pattern Number	Alliance Color Number	Finish

Model Number

Alliance Program Price Grades

	A	B	C	D	E	F	G	H	I	J
N92M3LM	\$ 3849	\$ 4129	\$ 4373	\$ 4617	\$ 4873	\$ 5166	\$ 5374	\$ 5654	\$ 5959	\$ 6228
N92M3M	3376	3608	3810	4012	4224	4467	4638	4871	5123	5345
N92M3R	3667	3932	4162	4392	4633	4909	5105	5369	5657	5910
N92M3RM	3849	4129	4373	4617	4873	5166	5374	5654	5959	6228
N92M3RR	3906	4171	4401	4631	4872	5148	5344	5608	5896	6149
N92MC2	4121	4273	4405	4537	4675	4834	4946	5098	5263	5408
N92MC3	5797	6066	6300	6534	6779	7060	7259	7528	7821	8078
N92MIN9	2469	2586	2688	2790	2897	3020	3106	3224	3351	3463
N92MOU9	2435	2531	2615	2699	2787	2888	2960	3056	3161	3254
N92MSQ9D	2200	2299	2385	2471	2562	2665	2738	2837	2944	3039
N92MSQ9L	2181	2269	2345	2421	2501	2592	2656	2744	2839	2922
N92MSQ9R	2181	2269	2345	2421	2501	2592	2656	2744	2839	2922
N92MTL2B	4740	4915	5067	5219	5378	5561	5690	5865	6055	6222
N92MTL2BB	5217	5392	5544	5696	5855	6038	6167	6342	6532	6699
N92MTL2BL	4979	5154	5306	5458	5617	5800	5929	6104	6294	6461
N92MTL2BM	5106	5315	5497	5679	5870	6089	6243	6453	6680	6880
N92MTL2BR	4979	5154	5306	5458	5617	5800	5929	6104	6294	6461
N92MTL2L	4451	4596	4722	4848	4981	5132	5239	5384	5541	5680
N92MTL2LL	4690	4835	4961	5087	5220	5371	5478	5623	5780	5919
N92MTL2LM	4632	4793	4933	5073	5220	5388	5507	5668	5843	5997
N92MTL2M	4163	4278	4378	4478	4583	4703	4788	4903	5028	5138
N92MTL2R	4451	4596	4722	4848	4981	5132	5239	5384	5541	5680
N92MTL2RM	4632	4793	4933	5073	5220	5388	5507	5668	5843	5997
N92MTL2RR	4690	4835	4961	5087	5220	5371	5478	5623	5780	5919
N92MTL3B	6380	6601	6793	6985	7186	7417	7580	7801	8041	8252
N92MTL3BB	6858	7079	7271	7463	7664	7895	8058	8279	8519	8730
N92MTL3BL	6619	6840	7032	7224	7425	7656	7819	8040	8280	8491
N92MTL3BM	6746	7001	7223	7445	7678	7945	8133	8389	8666	8910
N92MTL3BR	6619	6840	7032	7224	7425	7656	7819	8040	8280	8491
N92MTL3L	6091	6282	6448	6614	6789	6988	7129	7320	7527	7710
N92MTL3LL	6330	6521	6687	6853	7028	7227	7368	7559	7766	7949
N92MTL3LM	6273	6480	6660	6840	7029	7245	7398	7605	7830	8028
N92MTL3M	5800	5959	6097	6235	6380	6545	6663	6821	6994	7146
N92MTL3R	6091	6282	6448	6614	6789	6988	7129	7320	7527	7710
N92MTL3RM	6273	6480	6660	6840	7029	7245	7398	7605	7830	8028
N92MTL3RR	6330	6521	6687	6853	7028	7227	7368	7559	7766	7949
N92MTLC2	5640	5713	5777	5841	5908	5985	6040	6113	6193	6264
N92MTLC3	7575	7674	7760	7846	7937	8040	8113	8212	8319	8414
N92MTLIN9	3629	3700	3762	3824	3889	3964	4016	4088	4165	4233
N92MTLSQ9D	3772	3825	3871	3917	3966	4021	4060	4113	4170	4221
N92MTLSQ9L	3765	3813	3855	3897	3941	3992	4027	4076	4128	4174
N92MTLSQ9R	3765	3813	3855	3897	3941	3992	4027	4076	4128	4174
N92MTU2B	3974	4200	4396	4592	4798	5033	5199	5425	5670	5885
N92MTU2BB	4451	4677	4873	5069	5275	5510	5676	5902	6147	6362
N92MTU2BL	4213	4439	4635	4831	5037	5272	5438	5664	5909	6124
N92MTU2BM	4340	4600	4826	5052	5290	5561	5753	6013	6295	6544
N92MTU2BR	4213	4439	4635	4831	5037	5272	5438	5664	5909	6124

Model Number	Alliance Program Price Grades									
	K	L	M	N	O	P	Q	R	S	T
N92M3LM	\$ 6679	\$ 7594	\$ 8143	\$ 8448	\$ 8741	\$ 9021	\$ 9314	\$ 9595	\$ 9888	\$ 10168
N92M3M	5719	6477	6931	7184	7426	7658	7901	8133	8375	8608
N92M3R	6335	7198	7715	8003	8279	8543	8819	9084	9360	9624
N92M3RM	6679	7594	8143	8448	8741	9021	9314	9595	9888	10168
N92M3RR	6574	7437	7954	8242	8518	8782	9058	9323	9599	9863
N92MC2	5652	6147	6444	6609	6767	6919	7078	7229	7388	7540
N92MC3	8511	9389	9915	10208	10488	10757	11038	11307	11588	11857
N92MIN9	3652	4035	4264	4392	4514	4631	4754	4871	4993	5111
N92MOU9	3409	3724	3913	4018	4119	4215	4316	4413	4514	4610
N92MSQ9D	3198	3521	3714	3822	3925	4024	4127	4226	4329	4428
N92MSQ9L	3063	3348	3519	3614	3705	3793	3884	3971	4062	4150
N92MSQ9R	3063	3348	3519	3614	3705	3793	3884	3971	4062	4150
N92MTL2B	6503	7073	7415	7605	7787	7962	8145	8319	8502	8677
N92MTL2BB	6980	7550	7892	8082	8264	8439	8622	8796	8979	9154
N92MTL2BL	6742	7312	7654	7844	8026	8201	8384	8558	8741	8916
N92MTL2BM	7217	7900	8309	8537	8755	8964	9183	9392	9610	9820
N92MTL2BR	6742	7312	7654	7844	8026	8201	8384	8558	8741	8916
N92MTL2L	5913	6386	6669	6827	6978	7123	7274	7419	7570	7715
N92MTL2LL	6152	6625	6908	7066	7217	7362	7513	7658	7809	7954
N92MTL2LM	6256	6781	7096	7271	7439	7600	7768	7929	8097	8258
N92MTL2M	5323	5698	5923	6048	6168	6283	6403	6518	6638	6753
N92MTL2R	5913	6386	6669	6827	6978	7123	7274	7419	7570	7715
N92MTL2RM	6256	6781	7096	7271	7439	7600	7768	7929	8097	8258
N92MTL2RR	6152	6625	6908	7066	7217	7362	7513	7658	7809	7954
N92MTL3B	8607	9327	9759	9999	10229	10450	10681	10901	11132	11353
N92MTL3BB	9085	9805	10237	10477	10707	10928	11159	11379	11610	11831
N92MTL3BL	8846	9566	9998	10238	10468	10689	10920	11140	11371	11592
N92MTL3BM	9321	10154	10653	10931	11197	11452	11719	11974	12240	12496
N92MTL3BR	8846	9566	9998	10238	10468	10689	10920	11140	11371	11592
N92MTL3L	8017	8640	9013	9221	9420	9611	9810	10001	10200	10391
N92MTL3LL	8256	8879	9252	9460	9659	9850	10049	10240	10439	10630
N92MTL3LM	8361	9036	9441	9666	9882	10089	10305	10512	10728	10935
N92MTL3M	7401	7919	8229	8402	8567	8726	8891	9050	9216	9374
N92MTL3R	8017	8640	9013	9221	9420	9611	9810	10001	10200	10391
N92MTL3RM	8361	9036	9441	9666	9882	10089	10305	10512	10728	10935
N92MTL3RR	8256	8879	9252	9460	9659	9850	10049	10240	10439	10630
N92MTLC2	6382	6622	6766	6846	6923	6996	7073	7147	7224	7297
N92MTLC3	8573	8896	9089	9197	9300	9399	9502	9601	9704	9803
N92MTLIN9	4348	4581	4720	4798	4872	4943	5018	5089	5163	5235
N92MTLSQ9D	4306	4479	4582	4640	4695	4748	4803	4856	4911	4964
N92MTLSQ9L	4252	4410	4504	4557	4607	4655	4706	4754	4804	4853
N92MTLSQ9R	4252	4410	4504	4557	4607	4655	4706	4754	4804	4853
N92MTU2B	6248	6983	7424	7669	7904	8130	8365	8590	8825	9051
N92MTU2BB	6725	7460	7901	8146	8381	8607	8842	9067	9302	9528
N92MTU2BL	6487	7222	7663	7908	8143	8369	8604	8829	9064	9290
N92MTU2BM	6962	7810	8318	8601	8872	9132	9403	9663	9934	10194
N92MTU2BR	6487	7222	7663	7908	8143	8369	8604	8829	9064	9290

Alliance Program Pricing

Finishes

IM	Brighton	CW	Cordovan
NM	Natural	DW	Judicial
HN	Honey	MH	Mocha
CL	Caramel	405	Designer White
TF	Truffle	462	Cinder
AC	Autumn	792	Sable
MC	Amber	793	Acorn

To order, specify the following:

1. Chair Model Number
2. Fabric Grade Letter
3. Alliance Pattern Number and Color Number/Name
4. Finish Number (when applicable)

Sample Order Number

<u>N14KK</u>	<u>A</u>	<u>403901</u>	<u>036</u>	<u>HN</u>
Model Number	Fabric Grade Letter	Alliance Pattern Number	Alliance Color Number	Finish

Model Number

Alliance Program Price Grades

	A	B	C	D	E	F	G	H	I	J
N92MTU2L	\$ 3682	\$ 3875	\$ 4043	\$ 4211	\$ 4388	\$ 4589	\$ 4732	\$ 4925	\$ 5135	\$ 5320
N92MTU2LL	3921	4114	4282	4450	4627	4828	4971	5164	5374	5559
N92MTU2LM	3867	4078	4262	4446	4639	4860	5017	5228	5458	5661
N92MTU2M	3394	3557	3699	3841	3990	4161	4281	4445	4622	4778
N92MTU2R	3682	3875	4043	4211	4388	4589	4732	4925	5135	5320
N92MTU2RM	3867	4078	4262	4446	4639	4860	5017	5228	5458	5661
N92MTU2RR	3921	4114	4282	4450	4627	4828	4971	5164	5374	5559
N92MTU3B	5228	5523	5779	6035	6304	6611	6828	7123	7443	7724
N92MTU3BB	5706	6001	6257	6513	6782	7089	7306	7601	7921	8202
N92MTU3BL	5467	5762	6018	6274	6543	6850	7067	7362	7682	7963
N92MTU3BM	5594	5923	6209	6495	6796	7139	7382	7711	8068	8383
N92MTU3BR	5467	5762	6018	6274	6543	6850	7067	7362	7682	7963
N92MTU3L	4940	5205	5435	5665	5906	6182	6378	6642	6930	7183
N92MTU3LL	5179	5444	5674	5904	6145	6421	6617	6881	7169	7422
N92MTU3LM	5122	5402	5646	5890	6146	6439	6647	6927	7232	7501
N92MTU3M	4649	4881	5083	5285	5497	5740	5911	6144	6396	6618
N92MTU3R	4940	5205	5435	5665	5906	6182	6378	6642	6930	7183
N92MTU3RM	5122	5402	5646	5890	6146	6439	6647	6927	7232	7501
N92MTU3RR	5179	5444	5674	5904	6145	6421	6617	6881	7169	7422
N92MTUC2	4945	5097	5229	5361	5499	5658	5770	5922	6087	6232
N92MTUC3	6621	6890	7124	7358	7603	7884	8083	8352	8645	8902
N92MTUIN9	3293	3410	3512	3614	3721	3844	3930	4048	4175	4287
N92MTUSQ9D	3024	3123	3209	3295	3386	3489	3562	3661	3768	3863
N92MTUSQ9L	3005	3093	3169	3245	3325	3416	3480	3568	3663	3746
N92MTUSQ9R	3005	3093	3169	3245	3325	3416	3480	3568	3663	3746
N92MTW2B	4740	4915	5067	5219	5378	5561	5690	5865	6055	6222
N92MTW2BB	5217	5392	5544	5696	5855	6038	6167	6342	6532	6699
N92MTW2BL	4979	5154	5306	5458	5617	5800	5929	6104	6294	6461
N92MTW2BM	5106	5315	5497	5679	5870	6089	6243	6453	6680	6880
N92MTW2BR	4979	5154	5306	5458	5617	5800	5929	6104	6294	6461
N92MTW2L	4451	4596	4722	4848	4981	5132	5239	5384	5541	5680
N92MTW2LL	4690	4835	4961	5087	5220	5371	5478	5623	5780	5919
N92MTW2LM	4632	4793	4933	5073	5220	5388	5507	5668	5843	5997
N92MTW2M	4163	4278	4378	4478	4583	4703	4788	4903	5028	5138
N92MTW2R	4451	4596	4722	4848	4981	5132	5239	5384	5541	5680
N92MTW2RM	4632	4793	4933	5073	5220	5388	5507	5668	5843	5997
N92MTW2RR	4690	4835	4961	5087	5220	5371	5478	5623	5780	5919
N92MTW3B	6380	6601	6793	6985	7186	7417	7580	7801	8041	8252
N92MTW3BB	6858	7079	7271	7463	7664	7895	8058	8279	8519	8730
N92MTW3BL	6619	6840	7032	7224	7425	7656	7819	8040	8280	8491
N92MTW3BM	6746	7001	7223	7445	7678	7945	8133	8389	8666	8910
N92MTW3BR	6619	6840	7032	7224	7425	7656	7819	8040	8280	8491
N92MTW3L	6091	6282	6448	6614	6789	6988	7129	7320	7527	7710
N92MTW3LL	6330	6521	6687	6853	7028	7227	7368	7559	7766	7949
N92MTW3LM	6273	6480	6660	6840	7029	7245	7398	7605	7830	8028
N92MTW3M	5800	5959	6097	6235	6380	6545	6663	6821	6994	7146
N92MTW3R	6091	6282	6448	6614	6789	6988	7129	7320	7527	7710

Model Number	Alliance Program Price Grades									
	K	L	M	N	O	P	Q	R	S	T
N92MTU2L	\$ 5631	\$ 6261	\$ 6639	\$ 6849	\$ 7051	\$ 7244	\$ 7445	\$ 7639	\$ 7840	\$ 8033
N92MTU2LL	5870	6500	6878	7088	7290	7483	7684	7878	8079	8272
N92MTU2LM	6001	6691	7105	7335	7556	7767	7988	8200	8421	8632
N92MTU2M	5041	5574	5893	6071	6241	6404	6575	6738	6908	7072
N92MTU2R	5631	6261	6639	6849	7051	7244	7445	7639	7840	8033
N92MTU2RM	6001	6691	7105	7335	7556	7767	7988	8200	8421	8632
N92MTU2RR	5870	6500	6878	7088	7290	7483	7684	7878	8079	8272
N92MTU3B	8198	9158	9734	10054	10361	10656	10963	11257	11564	11859
N92MTU3BB	8676	9636	10212	10532	10839	11134	11441	11735	12042	12337
N92MTU3BL	8437	9397	9973	10293	10600	10895	11202	11496	11803	12098
N92MTU3BM	8912	9985	10628	10986	11329	11658	12001	12330	12673	13002
N92MTU3BR	8437	9397	9973	10293	10600	10895	11202	11496	11803	12098
N92MTU3L	7608	8471	8988	9276	9552	9816	10092	10357	10633	10897
N92MTU3LL	7847	8710	9227	9515	9791	10055	10331	10596	10872	11136
N92MTU3LM	7952	8867	9416	9721	10014	10294	10587	10868	11161	11441
N92MTU3M	6992	7750	8204	8457	8699	8931	9174	9406	9648	9881
N92MTU3R	7608	8471	8988	9276	9552	9816	10092	10357	10633	10897
N92MTU3RM	7952	8867	9416	9721	10014	10294	10587	10868	11161	11441
N92MTU3RR	7847	8710	9227	9515	9791	10055	10331	10596	10872	11136
N92MTUC2	6476	6971	7268	7433	7591	7743	7902	8053	8212	8364
N92MTUC3	9335	10213	10739	11032	11312	11581	11862	12131	12412	12681
N92MTUIN9	4476	4859	5088	5216	5338	5455	5578	5695	5817	5935
N92MTUSQ9D	4022	4345	4538	4646	4749	4848	4951	5050	5153	5252
N92MTUSQ9L	3887	4172	4343	4438	4529	4617	4708	4795	4886	4974
N92MTUSQ9R	3887	4172	4343	4438	4529	4617	4708	4795	4886	4974
N92MTW2B	6503	7073	7415	7605	7787	7962	8145	8319	8502	8677
N92MTW2BB	6980	7550	7892	8082	8264	8439	8622	8796	8979	9154
N92MTW2BL	6742	7312	7654	7844	8026	8201	8384	8558	8741	8916
N92MTW2BM	7217	7900	8309	8537	8755	8964	9183	9392	9610	9820
N92MTW2BR	6742	7312	7654	7844	8026	8201	8384	8558	8741	8916
N92MTW2L	5913	6386	6669	6827	6978	7123	7274	7419	7570	7715
N92MTW2LL	6152	6625	6908	7066	7217	7362	7513	7658	7809	7954
N92MTW2LM	6256	6781	7096	7271	7439	7600	7768	7929	8097	8258
N92MTW2M	5323	5698	5923	6048	6168	6283	6403	6518	6638	6753
N92MTW2R	5913	6386	6669	6827	6978	7123	7274	7419	7570	7715
N92MTW2RM	6256	6781	7096	7271	7439	7600	7768	7929	8097	8258
N92MTW2RR	6152	6625	6908	7066	7217	7362	7513	7658	7809	7954
N92MTW3B	8607	9327	9759	9999	10229	10450	10681	10901	11132	11353
N92MTW3BB	9085	9805	10237	10477	10707	10928	11159	11379	11610	11831
N92MTW3BL	8846	9566	9998	10238	10468	10689	10920	11140	11371	11592
N92MTW3BM	9321	10154	10653	10931	11197	11452	11719	11974	12240	12496
N92MTW3BR	8846	9566	9998	10238	10468	10689	10920	11140	11371	11592
N92MTW3L	8017	8640	9013	9221	9420	9611	9810	10001	10200	10391
N92MTW3LL	8256	8879	9252	9460	9659	9850	10049	10240	10439	10630
N92MTW3LM	8361	9036	9441	9666	9882	10089	10305	10512	10728	10935
N92MTW3M	7401	7919	8229	8402	8567	8726	8891	9050	9216	9374
N92MTW3R	8017	8640	9013	9221	9420	9611	9810	10001	10200	10391

Alliance Program Pricing

Finishes

IM	Brighton	CW	Cordovan
NM	Natural	DW	Judicial
HN	Honey	MH	Mocha
CL	Caramel	405	Designer White
TF	Truffle	462	Cinder
AC	Autumn	792	Sable
MC	Amber	793	Acorn

To order, specify the following:

1. Chair Model Number
2. Fabric Grade Letter
3. Alliance Pattern Number and Color Number/Name
4. Finish Number (when applicable)

Sample Order Number

<u>N14KK</u>	<u>A</u>	<u>403901</u>	<u>036</u>	<u>HN</u>
Model Number	Fabric Grade Letter	Alliance Pattern Number	Alliance Color Number	Finish

Model Number

Alliance Program Price Grades

	A	B	C	D	E	F	G	H	I	J
N92MTW3RM	\$ 6273	\$ 6480	\$ 6660	\$ 6840	\$ 7029	\$ 7245	\$ 7398	\$ 7605	\$ 7830	\$ 8028
N92MTW3RR	6330	6521	6687	6853	7028	7227	7368	7559	7766	7949
N92MTWC2	5640	5713	5777	5841	5908	5985	6040	6113	6193	6264
N92MTWC3	7575	7674	7760	7846	7937	8040	8113	8212	8319	8414
N92MTWIN9	3629	3700	3762	3824	3889	3964	4016	4088	4165	4233
N92MTWSQ9D	3772	3825	3871	3917	3966	4021	4060	4113	4170	4221
N92MTWSQ9L	3765	3813	3855	3897	3941	3992	4027	4076	4128	4174
N92MTWSQ9R	3765	3813	3855	3897	3941	3992	4027	4076	4128	4174
N95AA	2412	2543	2657	2771	2890	3027	3124	3255	3398	3523
N95AAC	2560	2691	2805	2919	3038	3175	3272	3403	3546	3671
N95AAL	2633	2764	2878	2992	3111	3248	3345	3476	3619	3744
N95AALC	2783	2914	3028	3142	3261	3398	3495	3626	3769	3894
N95AAR	2633	2764	2878	2992	3111	3248	3345	3476	3619	3744
N95AARC	2783	2914	3028	3142	3261	3398	3495	3626	3769	3894
N95BB	3203	3353	3483	3613	3749	3905	4016	4165	4328	4471
N95BBB	3647	3797	3927	4057	4193	4349	4460	4609	4772	4915
N95BBL	3426	3576	3706	3836	3972	4128	4239	4388	4551	4694
N95BBR	3426	3576	3706	3836	3972	4128	4239	4388	4551	4694
N95CC	4047	4247	4421	4595	4777	4986	5134	5334	5552	5743
N95CCB	4492	4692	4866	5040	5222	5431	5579	5779	5997	6188
N95CCL	4270	4470	4644	4818	5000	5209	5357	5557	5775	5966
N95CCR	4270	4470	4644	4818	5000	5209	5357	5557	5775	5966
N95DD	1405	1465	1517	1569	1623	1686	1730	1790	1855	1912
N95DDC	1553	1613	1665	1717	1771	1834	1878	1938	2003	2060
N95EE	1933	2011	2079	2147	2219	2300	2358	2436	2521	2596
N95GG	2524	2660	2778	2896	3020	3161	3262	3397	3545	3675
N95MA	1804	1875	1937	1999	2064	2139	2191	2263	2340	2408
N95MAC	1952	2023	2085	2147	2212	2287	2339	2411	2488	2556
N95MAL	2087	2188	2276	2364	2457	2562	2637	2738	2848	2945
N95MALT	2351	2452	2540	2628	2721	2826	2901	3002	3112	3209
N95MAR	2087	2188	2276	2364	2457	2562	2637	2738	2848	2945
N95MART	2351	2452	2540	2628	2721	2826	2901	3002	3112	3209
N95MB	2628	2739	2835	2931	3032	3147	3228	3339	3459	3564
N95MBL	2882	3004	3110	3216	3328	3455	3545	3667	3799	3916
N95MBLT	3145	3267	3373	3479	3591	3718	3808	3930	4062	4179
N95MBR	2882	3004	3110	3216	3328	3455	3545	3667	3799	3916
N95MBRT	3145	3267	3373	3479	3591	3718	3808	3930	4062	4179
N95MC	3463	3617	3751	3885	4025	4186	4300	4454	4622	4769
N95MCL	3723	3893	4041	4189	4345	4522	4648	4818	5003	5166
N95MCLT	3987	4157	4305	4453	4609	4786	4912	5082	5267	5430
N95MCR	3723	3893	4041	4189	4345	4522	4648	4818	5003	5166
N95MCRT	3987	4157	4305	4453	4609	4786	4912	5082	5267	5430
N95MH	1726	1786	1838	1890	1944	2007	2051	2111	2176	2233
N95MHA	1718	1773	1821	1869	1920	1977	2018	2073	2133	2186
N95MJ	2008	2079	2141	2203	2268	2343	2395	2467	2544	2612
N95MJA	1993	2055	2109	2163	2219	2284	2330	2392	2460	2519
N95MK	2609	2708	2794	2880	2971	3074	3147	3246	3353	3448

Model Number	Alliance Program Price Grades									
	K	L	M	N	O	P	Q	R	S	T
N92MTW3RM	\$ 8361	\$ 9036	\$ 9441	\$ 9666	\$ 9882	\$ 10089	\$ 10305	\$ 10512	\$ 10728	\$ 10935
N92MTW3RR	8256	8879	9252	9460	9659	9850	10049	10240	10439	10630
N92MTWC2	6382	6622	6766	6846	6923	6996	7073	7147	7224	7297
N92MTWC3	8573	8896	9089	9197	9300	9399	9502	9601	9704	9803
N92MTWIN9	4348	4581	4720	4798	4872	4943	5018	5089	5163	5235
N92MTWSQ9D	4306	4479	4582	4640	4695	4748	4803	4856	4911	4964
N92MTWSQ9L	4252	4410	4504	4557	4607	4655	4706	4754	4804	4853
N92MTWSQ9R	4252	4410	4504	4557	4607	4655	4706	4754	4804	4853
N95AA	3734	4162	4418	4561	4697	4828	4965	5096	5233	5364
N95AAC	3882	4310	4566	4709	4845	4976	5113	5244	5381	5512
N95AAL	3955	4383	4639	4782	4918	5049	5186	5317	5454	5585
N95AALC	4105	4533	4789	4932	5068	5199	5336	5467	5604	5735
N95AAR	3955	4383	4639	4782	4918	5049	5186	5317	5454	5585
N95AARC	4105	4533	4789	4932	5068	5199	5336	5467	5604	5735
N95BB	4711	5199	5491	5654	5810	5959	6115	6265	6421	6570
N95BBB	5155	5643	5935	6098	6254	6403	6559	6709	6865	7014
N95BBL	4934	5422	5714	5877	6033	6182	6338	6488	6644	6793
N95BBR	4934	5422	5714	5877	6033	6182	6338	6488	6644	6793
N95CC	6065	6718	7109	7327	7535	7735	7944	8144	8353	8553
N95CCB	6510	7163	7554	7772	7980	8180	8389	8589	8798	8998
N95CCL	6288	6941	7332	7550	7758	7958	8167	8367	8576	8776
N95CCR	6288	6941	7332	7550	7758	7958	8167	8367	8576	8776
N95DD	2008	2203	2320	2385	2447	2507	2570	2629	2692	2752
N95DDC	2156	2351	2468	2533	2595	2655	2718	2777	2840	2900
N95EE	2722	2977	3130	3215	3297	3375	3456	3535	3616	3694
N95GG	3893	4336	4601	4749	4890	5026	5167	5303	5445	5580
N95MA	2523	2756	2895	2973	3047	3118	3193	3264	3338	3410
N95MAC	2671	2904	3043	3121	3195	3266	3341	3412	3486	3558
N95MAL	3108	3438	3636	3746	3852	3953	4058	4160	4265	4366
N95MALT	3372	3702	3900	4010	4116	4217	4322	4424	4529	4630
N95MAR	3108	3438	3636	3746	3852	3953	4058	4160	4265	4366
N95MART	3372	3702	3900	4010	4116	4217	4322	4424	4529	4630
N95MB	3742	4102	4318	4438	4553	4664	4779	4889	5004	5115
N95MBL	4112	4510	4748	4881	5008	5130	5257	5379	5506	5628
N95MBLT	4375	4773	5011	5144	5271	5393	5520	5642	5769	5891
N95MBR	4112	4510	4748	4881	5008	5130	5257	5379	5506	5628
N95MBRT	4375	4773	5011	5144	5271	5393	5520	5642	5769	5891
N95MC	5017	5520	5821	5989	6149	6303	6464	6618	6779	6933
N95MCL	5440	5995	6328	6513	6691	6861	7038	7209	7386	7556
N95MCLT	5704	6259	6592	6777	6955	7125	7302	7473	7650	7820
N95MCR	5440	5995	6328	6513	6691	6861	7038	7209	7386	7556
N95MCRT	5704	6259	6592	6777	6955	7125	7302	7473	7650	7820
N95MH	2329	2524	2641	2706	2768	2828	2891	2950	3013	3073
N95MHA	2275	2455	2563	2623	2681	2736	2793	2849	2906	2961
N95MJ	2727	2960	3099	3177	3251	3322	3397	3468	3542	3614
N95MJA	2619	2822	2943	3011	3075	3137	3202	3264	3329	3391
N95MK	3607	3930	4123	4231	4334	4433	4536	4635	4738	4837

Alliance Program Pricing

Finishes

IM	Brighton	CW	Cordovan
NM	Natural	DW	Judicial
HN	Honey	MH	Mocha
CL	Caramel	405	Designer White
TF	Truffle	462	Cinder
AC	Autumn	792	Sable
MC	Amber	793	Acorn

To order, specify the following:

1. Chair Model Number
2. Fabric Grade Letter
3. Alliance Pattern Number and Color Number/Name
4. Finish Number (when applicable)

Sample Order Number

<u>N14KK</u>	<u>A</u>	<u>403901</u>	<u>036</u>	<u>HN</u>
Model Number	Fabric Grade Letter	Alliance Pattern Number	Alliance Color Number	Finish

Model Number

Alliance Program Price Grades

	A	B	C	D	E	F	G	H	I	J
N95MKA	\$ 2564	\$ 2635	\$ 2697	\$ 2759	\$ 2824	\$ 2899	\$ 2951	\$ 3023	\$ 3100	\$ 3168
NAC1824CUSH										
NAC1830CUSH										
NAC1836CUSH										
NAC1848CUSH										
NAC1860CUSH										
NAC1872CUSH										
NAC2124CUSH										
NAC2130CUSH										
NAC2136CUSH										
NAC2148CUSH										
NAC2160CUSH										
NAC2172CUSH										
NAC2424CUSH										
NAC2430CUSH										
NAC2436CUSH										
NAC2448CUSH										
NAC2460CUSH										
NAC2472CUSH										
451	1195	1271	1337	1403	1473	1552	1608	1684	1766	1839
451T	1244	1327	1399	1471	1546	1633	1694	1777	1867	1946
452	1211	1287	1353	1419	1489	1568	1624	1700	1782	1855
452T	1255	1338	1410	1482	1557	1644	1705	1788	1878	1957

Model Number	Alliance Program Price Grades									
	K	L	M	N	O	P	Q	R	S	T
N95MKA	\$ 3283	\$ 3516	\$ 3655	\$ 3733	\$ 3807	\$ 3878	\$ 3953	\$ 4024	\$ 4098	\$ 4170
NAC1824CUSH										
NAC1830CUSH										
NAC1836CUSH										
NAC1848CUSH										
NAC1860CUSH										
NAC1872CUSH										
NAC2124CUSH										
NAC2130CUSH										
NAC2136CUSH										
NAC2148CUSH										
NAC2160CUSH										
NAC2172CUSH										
NAC2424CUSH										
NAC2430CUSH										
NAC2436CUSH										
NAC2448CUSH										
NAC2460CUSH										
NAC2472CUSH										
451	1961	2209	2357	2440	2519	2595	2674	2750	2829	2905
451T	2079	2349	2511	2601	2687	2770	2857	2939	3026	3109
452	1977	2225	2373	2456	2535	2611	2690	2766	2845	2921
452T	2090	2360	2522	2612	2698	2781	2868	2950	3037	3120

Alliance Program TB133 Fire Rated Pricing

Finishes

IM	Brighton	CW	Cordovan
NM	Natural	DW	Judicial
HN	Honey	MH	Mocha
CL	Caramel	405	Designer White
TF	Truffle	462	Cinder
AC	Autumn	792	Sable
MC	Amber	793	Acorn

To order, specify the following:

1. Chair Model Number
2. Fabric Grade Letter
3. Alliance Pattern Number and Color Number/Name
4. Finish Number (when applicable)

Sample Order Number

<u>N14KKF</u>	<u>A</u>	<u>403901</u>	<u>036</u>	<u>HN</u>
Model Number	Fabric Grade Letter	Alliance Pattern Number	Alliance Color Number	Finish

Model Number

Alliance Program TB133 Price Grades

	A	B	C	D	E	F	G	H	I	J
N12AACF	\$ 974	\$ 1001	\$ 1025	\$ 1049	\$ 1074	\$ 1103	\$ 1124	\$ 1151	\$ 1181	\$ 1208
N12AACSF	1069	1096	1120	1144	1169	1198	1219	1246	1276	1303
N12AAYF	1095	1122	1146	1170	1195	1224	1245	1272	1302	1329
N12ARF	891	918	942	966	991	1020	1041	1068	1098	1125
N12ARSF	986	1013	1037	1061	1086	1115	1136	1163	1193	1220
N12ARYF	1012	1039	1063	1087	1112	1141	1162	1189	1219	1246
N12BBCF	1048	1083	1113	1143	1174	1210	1236	1270	1308	1341
N12BBCSF	1144	1179	1209	1239	1270	1306	1332	1366	1404	1437
N12BBYF	1169	1204	1234	1264	1295	1331	1357	1391	1429	1462
N12BRF	965	1000	1030	1060	1091	1127	1153	1187	1225	1258
N12BRSF	1061	1096	1126	1156	1187	1223	1249	1283	1321	1354
N12BRYF	1087	1122	1152	1182	1213	1249	1275	1309	1347	1380
N12CCCF	1129	1156	1180	1204	1229	1258	1279	1306	1336	1363
N12CCCSF	1224	1251	1275	1299	1324	1353	1374	1401	1431	1458
N12CCYF	1252	1279	1303	1327	1352	1381	1402	1429	1459	1486
N12CRF	1046	1073	1097	1121	1146	1175	1196	1223	1253	1280
N12CRSF	1141	1168	1192	1216	1241	1270	1291	1318	1348	1375
N12CRYF	1168	1195	1219	1243	1268	1297	1318	1345	1375	1402
N12DDCF	1207	1242	1272	1302	1333	1369	1395	1429	1467	1500
N12DDCSF	1303	1338	1368	1398	1429	1465	1491	1525	1563	1596
N12DDYF	1330	1365	1395	1425	1456	1492	1518	1552	1590	1623
N12DRF	1125	1160	1190	1220	1251	1287	1313	1347	1385	1418
N12DRSF	1220	1255	1285	1315	1346	1382	1408	1442	1480	1513
N12DRYF	1245	1280	1310	1340	1371	1407	1433	1467	1505	1538
N12EECF	1173	1203	1229	1255	1283	1314	1336	1366	1398	1427
N12EECSF	1269	1299	1325	1351	1379	1410	1432	1462	1494	1523
N12ERF	1091	1121	1147	1173	1201	1232	1254	1284	1316	1345
N12ERSF	1185	1215	1241	1267	1295	1326	1348	1378	1410	1439
N12HHCF	1252	1289	1321	1353	1386	1425	1452	1489	1529	1564
N12HHCSF	1348	1385	1417	1449	1482	1521	1548	1585	1625	1660
N12HRF	1169	1206	1238	1270	1303	1342	1369	1406	1446	1481
N12HRSF	1263	1300	1332	1364	1397	1436	1463	1500	1540	1575
N12JJCEF	1260	1287	1311	1335	1360	1389	1410	1437	1467	1494
N12JJCESF	1356	1383	1407	1431	1456	1485	1506	1533	1563	1590
N12JJCF	1150	1177	1201	1225	1250	1279	1300	1327	1357	1384
N12JJCSF	1244	1271	1295	1319	1344	1373	1394	1421	1451	1478
N12JJYEF	1380	1407	1431	1455	1480	1509	1530	1557	1587	1614
N12JJYF	1270	1297	1321	1345	1370	1399	1420	1447	1477	1504
N12JREF	1177	1204	1228	1252	1277	1306	1327	1354	1384	1411
N12JRESF	1271	1298	1322	1346	1371	1400	1421	1448	1478	1505
N12JRF	1067	1094	1118	1142	1167	1196	1217	1244	1274	1301
N12JRFSF	1161	1188	1212	1236	1261	1290	1311	1338	1368	1395
N12JRYEF	1298	1325	1349	1373	1398	1427	1448	1475	1505	1532
N12JRYF	1188	1215	1239	1263	1288	1317	1338	1365	1395	1422
N12KKCEF	1336	1371	1401	1431	1462	1498	1524	1558	1596	1629
N12KKCESF	1435	1470	1500	1530	1561	1597	1623	1657	1695	1728
N12KKCF	1226	1261	1291	1321	1352	1388	1414	1448	1486	1519

Model Number	Alliance Program TB133 Price Grades									
	K	L	M	N	O	P	Q	R	S	T
N12AACF	\$ 1252	\$ 1342	\$ 1396	\$ 1426	\$ 1455	\$ 1482	\$ 1511	\$ 1539	\$ 1568	\$ 1595
N12AACSF	1347	1437	1491	1521	1550	1577	1606	1634	1663	1690
N12AAYF	1373	1463	1517	1547	1576	1603	1632	1660	1689	1716
N12ARF	1169	1259	1313	1343	1372	1399	1428	1456	1485	1512
N12ARSF	1264	1354	1408	1438	1467	1494	1523	1551	1580	1607
N12ARYF	1290	1380	1434	1464	1493	1520	1549	1577	1606	1633
N12BBCF	1396	1509	1576	1614	1650	1684	1720	1755	1791	1825
N12BBCSF	1492	1605	1672	1710	1746	1780	1816	1851	1887	1921
N12BBYF	1517	1630	1697	1735	1771	1805	1841	1876	1912	1946
N12BRF	1313	1426	1493	1531	1567	1601	1637	1672	1708	1742
N12BRSF	1409	1522	1589	1627	1663	1697	1733	1768	1804	1838
N12BRYF	1435	1548	1615	1653	1689	1723	1759	1794	1830	1864
N12CCCF	1407	1497	1551	1581	1610	1637	1666	1694	1723	1750
N12CCCSF	1502	1592	1646	1676	1705	1732	1761	1789	1818	1845
N12CCYF	1530	1620	1674	1704	1733	1760	1789	1817	1846	1873
N12CRF	1324	1414	1468	1498	1527	1554	1583	1611	1640	1667
N12CRSF	1419	1509	1563	1593	1622	1649	1678	1706	1735	1762
N12CRYF	1446	1536	1590	1620	1649	1676	1705	1733	1762	1789
N12DDCF	1555	1668	1735	1773	1809	1843	1879	1914	1950	1984
N12DDCSF	1651	1764	1831	1869	1905	1939	1975	2010	2046	2080
N12DDYF	1678	1791	1858	1896	1932	1966	2002	2037	2073	2107
N12DRF	1473	1586	1653	1691	1727	1761	1797	1832	1868	1902
N12DRSF	1568	1681	1748	1786	1822	1856	1892	1927	1963	1997
N12DRYF	1593	1706	1773	1811	1847	1881	1917	1952	1988	2022
N12EECF	1475	1573	1631	1664	1695	1725	1756	1786	1817	1847
N12EECSF	1571	1669	1727	1760	1791	1821	1852	1882	1913	1943
N12ERF	1393	1491	1549	1582	1613	1643	1674	1704	1735	1765
N12ERSF	1487	1585	1643	1676	1707	1737	1768	1798	1829	1859
N12HHCF	1623	1743	1815	1855	1893	1930	1969	2005	2044	2081
N12HHCSF	1719	1839	1911	1951	1989	2026	2065	2101	2140	2177
N12HRF	1540	1660	1732	1772	1810	1847	1886	1922	1961	1998
N12HRSF	1634	1754	1826	1866	1904	1941	1980	2016	2055	2092
N12JJCEF	1538	1628	1682	1712	1741	1768	1797	1825	1854	1881
N12JJCESF	1634	1724	1778	1808	1837	1864	1893	1921	1950	1977
N12JJCF	1428	1518	1572	1602	1631	1658	1687	1715	1744	1771
N12JJCSF	1522	1612	1666	1696	1725	1752	1781	1809	1838	1865
N12JJYEF	1658	1748	1802	1832	1861	1888	1917	1945	1974	2001
N12JJYF	1548	1638	1692	1722	1751	1778	1807	1835	1864	1891
N12JREF	1455	1545	1599	1629	1658	1685	1714	1742	1771	1798
N12JRESF	1549	1639	1693	1723	1752	1779	1808	1836	1865	1892
N12JRF	1345	1435	1489	1519	1548	1575	1604	1632	1661	1688
N12JRSF	1439	1529	1583	1613	1642	1669	1698	1726	1755	1782
N12JRYEF	1576	1666	1720	1750	1779	1806	1835	1863	1892	1919
N12JRYF	1466	1556	1610	1640	1669	1696	1725	1753	1782	1809
N12KKCEF	1684	1797	1864	1902	1938	1972	2008	2043	2079	2113
N12KKCESF	1783	1896	1963	2001	2037	2071	2107	2142	2178	2212
N12KKCF	1574	1687	1754	1792	1828	1862	1898	1933	1969	2003

Alliance Program TB133 Fire Rated Pricing

Finishes

IM	Brighton	CW	Cordovan
NM	Natural	DW	Judicial
HN	Honey	MH	Mocha
CL	Caramel	405	Designer White
TF	Truffle	462	Cinder
AC	Autumn	792	Sable
MC	Amber	793	Acorn

To order, specify the following:

1. Chair Model Number
2. Fabric Grade Letter
3. Alliance Pattern Number and Color Number/Name
4. Finish Number (when applicable)

Sample Order Number

<u>N14KKF</u>	<u>A</u>	<u>403901</u>	<u>036</u>	<u>HN</u>
Model Number	Fabric Grade Letter	Alliance Pattern Number	Alliance Color Number	Finish

Model Number

Alliance Program TB133 Price Grades

	A	B	C	D	E	F	G	H	I	J
N12KKCSF	\$ 1323	\$ 1358	\$ 1388	\$ 1418	\$ 1449	\$ 1485	\$ 1511	\$ 1545	\$ 1583	\$ 1616
N12KKYEF	1456	1491	1521	1551	1582	1618	1644	1678	1716	1749
N12KKYF	1346	1381	1411	1441	1472	1508	1534	1568	1606	1639
N12KREF	1252	1287	1317	1347	1378	1414	1440	1474	1512	1545
N12KRESF	1350	1385	1415	1445	1476	1512	1538	1572	1610	1643
N12KRF	1142	1177	1207	1237	1268	1304	1330	1364	1402	1435
N12KRFSF	1240	1275	1305	1335	1366	1402	1428	1462	1500	1533
N12KRYEF	1374	1409	1439	1469	1500	1536	1562	1596	1634	1667
N12KRYF	1264	1299	1329	1359	1390	1426	1452	1486	1524	1557
N12MMCEF	1302	1332	1358	1384	1412	1443	1465	1495	1527	1556
N12MMCESF	1397	1427	1453	1479	1507	1538	1560	1590	1622	1651
N12MMCF	1191	1221	1247	1273	1301	1332	1354	1384	1416	1445
N12MMCSF	1287	1317	1343	1369	1397	1428	1450	1480	1512	1541
N12MREF	1218	1248	1274	1300	1328	1359	1381	1411	1443	1472
N12MRESF	1315	1345	1371	1397	1425	1456	1478	1508	1540	1569
N12MRF	1108	1138	1164	1190	1218	1249	1271	1301	1333	1362
N12MRSF	1205	1235	1261	1287	1315	1346	1368	1398	1430	1459
N12PPCEF	1381	1418	1450	1482	1515	1554	1581	1618	1658	1693
N12PPCESF	1475	1512	1544	1576	1609	1648	1675	1712	1752	1787
N12PPCF	1269	1306	1338	1370	1403	1442	1469	1506	1546	1581
N12PPCSF	1365	1402	1434	1466	1499	1538	1565	1602	1642	1677
N12PREF	1296	1333	1365	1397	1430	1469	1496	1533	1573	1608
N12PRESF	1393	1430	1462	1494	1527	1566	1593	1630	1670	1705
N12PRF	1186	1223	1255	1287	1320	1359	1386	1423	1463	1498
N12PRSF	1283	1320	1352	1384	1417	1456	1483	1520	1560	1595
N12QQF	849	881	909	937	967	1000	1024	1056	1091	1122
N12RRF	772	797	819	841	864	891	909	935	962	986
N13CCCF	1223	1250	1274	1298	1323	1352	1373	1400	1430	1457
N13CCCSF	1319	1346	1370	1394	1419	1448	1469	1496	1526	1553
N13CCYF	1343	1370	1394	1418	1443	1472	1493	1520	1550	1577
N13CRF	1140	1167	1191	1215	1240	1269	1290	1317	1347	1374
N13CRSF	1234	1261	1285	1309	1334	1363	1384	1411	1441	1468
N13CRYF	1262	1289	1313	1337	1362	1391	1412	1439	1469	1496
N13DDCF	1302	1337	1367	1397	1428	1464	1490	1524	1562	1595
N13DDCSF	1395	1430	1460	1490	1521	1557	1583	1617	1655	1688
N13DDYF	1422	1457	1487	1517	1548	1584	1610	1644	1682	1715
N13DRF	1218	1253	1283	1313	1344	1380	1406	1440	1478	1511
N13DRSF	1313	1348	1378	1408	1439	1475	1501	1535	1573	1606
N13DRYF	1340	1375	1405	1435	1466	1502	1528	1562	1600	1633
N13EECF	1268	1298	1324	1350	1378	1409	1431	1461	1493	1522
N13EECSF	1360	1390	1416	1442	1470	1501	1523	1553	1585	1614
N13ERF	1184	1214	1240	1266	1294	1325	1347	1377	1409	1438
N13ERSF	1279	1309	1335	1361	1389	1420	1442	1472	1504	1533
N13HHCF	1347	1384	1416	1448	1481	1520	1547	1584	1624	1659
N13HHCSF	1440	1477	1509	1541	1574	1613	1640	1677	1717	1752
N13HRF	1262	1299	1331	1363	1396	1435	1462	1499	1539	1574
N13HRSF	1358	1395	1427	1459	1492	1531	1558	1595	1635	1670

Model Number	Alliance Program TB133 Price Grades									
	K	L	M	N	O	P	Q	R	S	T
N12KKCSF	\$ 1671	\$ 1784	\$ 1851	\$ 1889	\$ 1925	\$ 1959	\$ 1995	\$ 2030	\$ 2066	\$ 2100
N12KKYEF	1804	1917	1984	2022	2058	2092	2128	2163	2199	2233
N12KKYF	1694	1807	1874	1912	1948	1982	2018	2053	2089	2123
N12KREF	1600	1713	1780	1818	1854	1888	1924	1959	1995	2029
N12KRESF	1698	1811	1878	1916	1952	1986	2022	2057	2093	2127
N12KRF	1490	1603	1670	1708	1744	1778	1814	1849	1885	1919
N12KRSF	1588	1701	1768	1806	1842	1876	1912	1947	1983	2017
N12KRYEF	1722	1835	1902	1940	1976	2010	2046	2081	2117	2151
N12KRYF	1612	1725	1792	1830	1866	1900	1936	1971	2007	2041
N12MMCEF	1604	1702	1760	1793	1824	1854	1885	1915	1946	1976
N12MMCESF	1699	1797	1855	1888	1919	1949	1980	2010	2041	2071
N12MMCF	1493	1591	1649	1682	1713	1743	1774	1804	1835	1865
N12MMCSF	1589	1687	1745	1778	1809	1839	1870	1900	1931	1961
N12MREF	1520	1618	1676	1709	1740	1770	1801	1831	1862	1892
N12MRESF	1617	1715	1773	1806	1837	1867	1898	1928	1959	1989
N12MRF	1410	1508	1566	1599	1630	1660	1691	1721	1752	1782
N12MRSF	1507	1605	1663	1696	1727	1757	1788	1818	1849	1879
N12PPCEF	1752	1872	1944	1984	2022	2059	2098	2134	2173	2210
N12PPCESF	1846	1966	2038	2078	2116	2153	2192	2228	2267	2304
N12PPCF	1640	1760	1832	1872	1910	1947	1986	2022	2061	2098
N12PPCSF	1736	1856	1928	1968	2006	2043	2082	2118	2157	2194
N12PREF	1667	1787	1859	1899	1937	1974	2013	2049	2088	2125
N12PRESF	1764	1884	1956	1996	2034	2071	2110	2146	2185	2222
N12PRF	1557	1677	1749	1789	1827	1864	1903	1939	1978	2015
N12PRSF	1654	1774	1846	1886	1924	1961	2000	2036	2075	2112
N12QQF	1174	1279	1342	1377	1411	1443	1476	1509	1542	1574
N12RRF	1027	1110	1159	1187	1213	1238	1265	1290	1316	1342
N13CCCF	1501	1591	1645	1675	1704	1731	1760	1788	1817	1844
N13CCCSF	1597	1687	1741	1771	1800	1827	1856	1884	1913	1940
N13CCYF	1621	1711	1765	1795	1824	1851	1880	1908	1937	1964
N13CRF	1418	1508	1562	1592	1621	1648	1677	1705	1734	1761
N13CRSF	1512	1602	1656	1686	1715	1742	1771	1799	1828	1855
N13CRYF	1540	1630	1684	1714	1743	1770	1799	1827	1856	1883
N13DDCF	1650	1763	1830	1868	1904	1938	1974	2009	2045	2079
N13DDCSF	1743	1856	1923	1961	1997	2031	2067	2102	2138	2172
N13DDYF	1770	1883	1950	1988	2024	2058	2094	2129	2165	2199
N13DRF	1566	1679	1746	1784	1820	1854	1890	1925	1961	1995
N13DRSF	1661	1774	1841	1879	1915	1949	1985	2020	2056	2090
N13DRYF	1688	1801	1868	1906	1942	1976	2012	2047	2083	2117
N13EECF	1570	1668	1726	1759	1790	1820	1851	1881	1912	1942
N13EECSF	1662	1760	1818	1851	1882	1912	1943	1973	2004	2034
N13ERF	1486	1584	1642	1675	1706	1736	1767	1797	1828	1858
N13ERSF	1581	1679	1737	1770	1801	1831	1862	1892	1923	1953
N13HHCF	1718	1838	1910	1950	1988	2025	2064	2100	2139	2176
N13HHCSF	1811	1931	2003	2043	2081	2118	2157	2193	2232	2269
N13HRF	1633	1753	1825	1865	1903	1940	1979	2015	2054	2091
N13HRSF	1729	1849	1921	1961	1999	2036	2075	2111	2150	2187

Alliance Program TB133 Fire Rated Pricing

Finishes

IM	Brighton	CW	Cordovan
NM	Natural	DW	Judicial
HN	Honey	MH	Mocha
CL	Caramel	405	Designer White
TF	Truffle	462	Cinder
AC	Autumn	792	Sable
MC	Amber	793	Acorn

To order, specify the following:

1. Chair Model Number
2. Fabric Grade Letter
3. Alliance Pattern Number and Color Number/Name
4. Finish Number (when applicable)

Sample Order Number

<u>N14KKF</u>	<u>A</u>	<u>403901</u>	<u>036</u>	<u>HN</u>
Model Number	Fabric Grade Letter	Alliance Pattern Number	Alliance Color Number	Finish

Model Number

Alliance Program TB133 Price Grades

	A	B	C	D	E	F	G	H	I	J
N13JJCF	\$ 1245	\$ 1272	\$ 1296	\$ 1320	\$ 1345	\$ 1374	\$ 1395	\$ 1422	\$ 1452	\$ 1479
N13JJCSF	1339	1366	1390	1414	1439	1468	1489	1516	1546	1573
N13JJYF	1367	1394	1418	1442	1467	1496	1517	1544	1574	1601
N13JRF	1162	1189	1213	1237	1262	1291	1312	1339	1369	1396
N13JRSF	1258	1285	1309	1333	1358	1387	1408	1435	1465	1492
N13JRYF	1285	1312	1336	1360	1385	1414	1435	1462	1492	1519
N13KKCF	1323	1358	1388	1418	1449	1485	1511	1545	1583	1616
N13KKCSF	1419	1454	1484	1514	1545	1581	1607	1641	1679	1712
N13KKYF	1445	1480	1510	1540	1571	1607	1633	1667	1705	1738
N13KRF	1240	1275	1305	1335	1366	1402	1428	1462	1500	1533
N13KRSF	1337	1372	1402	1432	1463	1499	1525	1559	1597	1630
N13KRYF	1362	1397	1427	1457	1488	1524	1550	1584	1622	1655
N13MMCF	1287	1317	1343	1369	1397	1428	1450	1480	1512	1541
N13MMCSF	1381	1411	1437	1463	1491	1522	1544	1574	1606	1635
N13MRF	1205	1235	1261	1287	1315	1346	1368	1398	1430	1459
N13MRSF	1299	1329	1355	1381	1409	1440	1462	1492	1524	1553
N13PPCF	1366	1403	1435	1467	1500	1539	1566	1603	1643	1678
N13PPCSF	1464	1501	1533	1565	1598	1637	1664	1701	1741	1776
N13PRF	1284	1321	1353	1385	1418	1457	1484	1521	1561	1596
N13PRSF	1382	1419	1451	1483	1516	1555	1582	1619	1659	1694
N14AACF	1053	1080	1104	1128	1153	1182	1203	1230	1260	1287
N14AACSF	1151	1178	1202	1226	1251	1280	1301	1328	1358	1385
N14AAYF	1175	1202	1226	1250	1275	1304	1325	1352	1382	1409
N14ARF	971	998	1022	1046	1071	1100	1121	1148	1178	1205
N14ARSF	1068	1095	1119	1143	1168	1197	1218	1245	1275	1302
N14ARYF	1092	1119	1143	1167	1192	1221	1242	1269	1299	1326
N14BBCF	1133	1168	1198	1228	1259	1295	1321	1355	1393	1426
N14BBCSF	1226	1261	1291	1321	1352	1388	1414	1448	1486	1519
N14BBYF	1255	1290	1320	1350	1381	1417	1443	1477	1515	1548
N14BRF	1050	1085	1115	1145	1176	1212	1238	1272	1310	1343
N14BRSF	1142	1177	1207	1237	1268	1304	1330	1364	1402	1435
N14BRYF	1171	1206	1236	1266	1297	1333	1359	1393	1431	1464
N14CCCF	1303	1330	1354	1378	1403	1432	1453	1480	1510	1537
N14CCCSF	1401	1428	1452	1476	1501	1530	1551	1578	1608	1635
N14CCYF	1426	1453	1477	1501	1526	1555	1576	1603	1633	1660
N14CRF	1221	1248	1272	1296	1321	1350	1371	1398	1428	1455
N14CRSF	1319	1346	1370	1394	1419	1448	1469	1496	1526	1553
N14CRYF	1341	1368	1392	1416	1441	1470	1491	1518	1548	1575
N14DDCF	1382	1417	1447	1477	1508	1544	1570	1604	1642	1675
N14DDCSF	1478	1513	1543	1573	1604	1640	1666	1700	1738	1771
N14DDYF	1504	1539	1569	1599	1630	1666	1692	1726	1764	1797
N14DRF	1301	1336	1366	1396	1427	1463	1489	1523	1561	1594
N14DRSF	1393	1428	1458	1488	1519	1555	1581	1615	1653	1686
N14DRYF	1421	1456	1486	1516	1547	1583	1609	1643	1681	1714
N14EECF	1348	1378	1404	1430	1458	1489	1511	1541	1573	1602
N14EECSF	1443	1473	1499	1525	1553	1584	1606	1636	1668	1697
N14ERF	1267	1297	1323	1349	1377	1408	1430	1460	1492	1521

Model Number	Alliance Program TB133 Price Grades									
	K	L	M	N	O	P	Q	R	S	T
N13JJCF	\$ 1523	\$ 1613	\$ 1667	\$ 1697	\$ 1726	\$ 1753	\$ 1782	\$ 1810	\$ 1839	\$ 1866
N13JJCSF	1617	1707	1761	1791	1820	1847	1876	1904	1933	1960
N13JJYF	1645	1735	1789	1819	1848	1875	1904	1932	1961	1988
N13JRF	1440	1530	1584	1614	1643	1670	1699	1727	1756	1783
N13JRSF	1536	1626	1680	1710	1739	1766	1795	1823	1852	1879
N13JRYF	1563	1653	1707	1737	1766	1793	1822	1850	1879	1906
N13KKCF	1671	1784	1851	1889	1925	1959	1995	2030	2066	2100
N13KKCSF	1767	1880	1947	1985	2021	2055	2091	2126	2162	2196
N13KKYF	1793	1906	1973	2011	2047	2081	2117	2152	2188	2222
N13KRF	1588	1701	1768	1806	1842	1876	1912	1947	1983	2017
N13KRSF	1685	1798	1865	1903	1939	1973	2009	2044	2080	2114
N13KRYF	1710	1823	1890	1928	1964	1998	2034	2069	2105	2139
N13MMCF	1589	1687	1745	1778	1809	1839	1870	1900	1931	1961
N13MMCSF	1683	1781	1839	1872	1903	1933	1964	1994	2025	2055
N13MRF	1507	1605	1663	1696	1727	1757	1788	1818	1849	1879
N13MRSF	1601	1699	1757	1790	1821	1851	1882	1912	1943	1973
N13PPCF	1737	1857	1929	1969	2007	2044	2083	2119	2158	2195
N13PPCSF	1835	1955	2027	2067	2105	2142	2181	2217	2256	2293
N13PRF	1655	1775	1847	1887	1925	1962	2001	2037	2076	2113
N13PRSF	1753	1873	1945	1985	2023	2060	2099	2135	2174	2211
N14AACF	1331	1421	1475	1505	1534	1561	1590	1618	1647	1674
N14AACSF	1429	1519	1573	1603	1632	1659	1688	1716	1745	1772
N14AAYF	1453	1543	1597	1627	1656	1683	1712	1740	1769	1796
N14ARF	1249	1339	1393	1423	1452	1479	1508	1536	1565	1592
N14ARSF	1346	1436	1490	1520	1549	1576	1605	1633	1662	1689
N14ARYF	1370	1460	1514	1544	1573	1600	1629	1657	1686	1713
N14BBCF	1481	1594	1661	1699	1735	1769	1805	1840	1876	1910
N14BBCSF	1574	1687	1754	1792	1828	1862	1898	1933	1969	2003
N14BBYF	1603	1716	1783	1821	1857	1891	1927	1962	1998	2032
N14BRF	1398	1511	1578	1616	1652	1686	1722	1757	1793	1827
N14BRSF	1490	1603	1670	1708	1744	1778	1814	1849	1885	1919
N14BRYF	1519	1632	1699	1737	1773	1807	1843	1878	1914	1948
N14CCCF	1581	1671	1725	1755	1784	1811	1840	1868	1897	1924
N14CCCSF	1679	1769	1823	1853	1882	1909	1938	1966	1995	2022
N14CCYF	1704	1794	1848	1878	1907	1934	1963	1991	2020	2047
N14CRF	1499	1589	1643	1673	1702	1729	1758	1786	1815	1842
N14CRSF	1597	1687	1741	1771	1800	1827	1856	1884	1913	1940
N14CRYF	1619	1709	1763	1793	1822	1849	1878	1906	1935	1962
N14DDCF	1730	1843	1910	1948	1984	2018	2054	2089	2125	2159
N14DDCSF	1826	1939	2006	2044	2080	2114	2150	2185	2221	2255
N14DDYF	1852	1965	2032	2070	2106	2140	2176	2211	2247	2281
N14DRF	1649	1762	1829	1867	1903	1937	1973	2008	2044	2078
N14DRSF	1741	1854	1921	1959	1995	2029	2065	2100	2136	2170
N14DRYF	1769	1882	1949	1987	2023	2057	2093	2128	2164	2198
N14EECF	1650	1748	1806	1839	1870	1900	1931	1961	1992	2022
N14EECSF	1745	1843	1901	1934	1965	1995	2026	2056	2087	2117
N14ERF	1569	1667	1725	1758	1789	1819	1850	1880	1911	1941

Alliance Program TB133 Fire Rated Pricing

Finishes

IM	Brighton	CW	Cordovan
NM	Natural	DW	Judicial
HN	Honey	MH	Mocha
CL	Caramel	405	Designer White
TF	Truffle	462	Cinder
AC	Autumn	792	Sable
MC	Amber	793	Acorn

To order, specify the following:

1. Chair Model Number
2. Fabric Grade Letter
3. Alliance Pattern Number and Color Number/Name
4. Finish Number (when applicable)

Sample Order Number

<u>N14KKF</u>	<u>A</u>	<u>403901</u>	<u>036</u>	<u>HN</u>
Model Number	Fabric Grade Letter	Alliance Pattern Number	Alliance Color Number	Finish

Model Number

Alliance Program TB133 Price Grades

	A	B	C	D	E	F	G	H	I	J
N14ERSF	\$ 1358	\$ 1388	\$ 1414	\$ 1440	\$ 1468	\$ 1499	\$ 1521	\$ 1551	\$ 1583	\$ 1612
N14HHCF	1426	1463	1495	1527	1560	1599	1626	1663	1703	1738
N14HHCSF	1524	1561	1593	1625	1658	1697	1724	1761	1801	1836
N14HRF	1343	1380	1412	1444	1477	1516	1543	1580	1620	1655
N14HRSF	1439	1476	1508	1540	1573	1612	1639	1676	1716	1751
N14JJCF	1328	1355	1379	1403	1428	1457	1478	1505	1535	1562
N14JJCSF	1424	1451	1475	1499	1524	1553	1574	1601	1631	1658
N14JJYF	1448	1475	1499	1523	1548	1577	1598	1625	1655	1682
N14JRF	1245	1272	1296	1320	1345	1374	1395	1422	1452	1479
N14JRSF	1339	1366	1390	1414	1439	1468	1489	1516	1546	1573
N14JRYF	1367	1394	1418	1442	1467	1496	1517	1544	1574	1601
N14KKCF	1406	1441	1471	1501	1532	1568	1594	1628	1666	1699
N14KKCSF	1498	1533	1563	1593	1624	1660	1686	1720	1758	1791
N14KKYF	1526	1561	1591	1621	1652	1688	1714	1748	1786	1819
N14KRF	1321	1356	1386	1416	1447	1483	1509	1543	1581	1614
N14KRSF	1417	1452	1482	1512	1543	1579	1605	1639	1677	1710
N14KRYF	1444	1479	1509	1539	1570	1606	1632	1666	1704	1737
N14MMCF	1372	1402	1428	1454	1482	1513	1535	1565	1597	1626
N14MMCSF	1464	1494	1520	1546	1574	1605	1627	1657	1689	1718
N14MRF	1287	1317	1343	1369	1397	1428	1450	1480	1512	1541
N14MRSF	1383	1413	1439	1465	1493	1524	1546	1576	1608	1637
N14PPCF	1452	1489	1521	1553	1586	1625	1652	1689	1729	1764
N14PPCSF	1545	1582	1614	1646	1679	1718	1745	1782	1822	1857
N14PRF	1367	1404	1436	1468	1501	1540	1567	1604	1644	1679
N14PRSF	1463	1500	1532	1564	1597	1636	1663	1700	1740	1775
N14QQF	920	952	980	1008	1038	1071	1095	1127	1162	1193
N14RRF	842	867	889	911	934	961	979	1005	1032	1056
N15AAYF	937	958	976	994	1013	1034	1050	1070	1093	1113
N15ARYF	854	875	893	911	930	951	967	987	1010	1030
N15CCYF	1092	1113	1131	1149	1168	1189	1205	1225	1248	1268
N15CRYF	1010	1031	1049	1067	1086	1107	1123	1143	1166	1186
N15EEF	999	1020	1038	1056	1075	1096	1112	1132	1155	1175
N15EESF	1094	1115	1133	1151	1170	1191	1207	1227	1250	1270
N15ERF	917	938	956	974	993	1014	1030	1050	1073	1093
N15ERSF	1012	1033	1051	1069	1088	1109	1125	1145	1168	1188
N15GGF	844	865	883	901	920	941	957	977	1000	1020
N15GGSF	939	960	978	996	1015	1036	1052	1072	1095	1115
N15GRF	761	782	800	818	837	858	874	894	917	937
N15GRSF	856	877	895	913	932	953	969	989	1012	1032
N15HHF	1110	1131	1149	1167	1186	1207	1223	1243	1266	1286
N15HHSF	1206	1227	1245	1263	1282	1303	1319	1339	1362	1382
N15HRF	1028	1049	1067	1085	1104	1125	1141	1161	1184	1204
N15HRSF	1122	1143	1161	1179	1198	1219	1235	1255	1278	1298
N15JJYEF	1222	1243	1261	1279	1298	1319	1335	1355	1378	1398
N15JJYF	1112	1133	1151	1169	1188	1209	1225	1245	1268	1288
N15JRYEF	1140	1161	1179	1197	1216	1237	1253	1273	1296	1316
N15JRYF	1030	1051	1069	1087	1106	1127	1143	1163	1186	1206

Model Number	Alliance Program TB133 Price Grades									
	K	L	M	N	O	P	Q	R	S	T
N14ERSF	\$ 1660	\$ 1758	\$ 1816	\$ 1849	\$ 1880	\$ 1910	\$ 1941	\$ 1971	\$ 2002	\$ 2032
N14HHCF	1797	1917	1989	2029	2067	2104	2143	2179	2218	2255
N14HHCSF	1895	2015	2087	2127	2165	2202	2241	2277	2316	2353
N14HRF	1714	1834	1906	1946	1984	2021	2060	2096	2135	2172
N14HRSF	1810	1930	2002	2042	2080	2117	2156	2192	2231	2268
N14JJCF	1606	1696	1750	1780	1809	1836	1865	1893	1922	1949
N14JJCSF	1702	1792	1846	1876	1905	1932	1961	1989	2018	2045
N14JJYF	1726	1816	1870	1900	1929	1956	1985	2013	2042	2069
N14JRF	1523	1613	1667	1697	1726	1753	1782	1810	1839	1866
N14JRSF	1617	1707	1761	1791	1820	1847	1876	1904	1933	1960
N14JRYF	1645	1735	1789	1819	1848	1875	1904	1932	1961	1988
N14KKCF	1754	1867	1934	1972	2008	2042	2078	2113	2149	2183
N14KKCSF	1846	1959	2026	2064	2100	2134	2170	2205	2241	2275
N14KKYF	1874	1987	2054	2092	2128	2162	2198	2233	2269	2303
N14KRF	1669	1782	1849	1887	1923	1957	1993	2028	2064	2098
N14KRSF	1765	1878	1945	1983	2019	2053	2089	2124	2160	2194
N14KRYF	1792	1905	1972	2010	2046	2080	2116	2151	2187	2221
N14MMCF	1674	1772	1830	1863	1894	1924	1955	1985	2016	2046
N14MMCSF	1766	1864	1922	1955	1986	2016	2047	2077	2108	2138
N14MRF	1589	1687	1745	1778	1809	1839	1870	1900	1931	1961
N14MRSF	1685	1783	1841	1874	1905	1935	1966	1996	2027	2057
N14PPCF	1823	1943	2015	2055	2093	2130	2169	2205	2244	2281
N14PPCSF	1916	2036	2108	2148	2186	2223	2262	2298	2337	2374
N14PRF	1738	1858	1930	1970	2008	2045	2084	2120	2159	2196
N14PRSF	1834	1954	2026	2066	2104	2141	2180	2216	2255	2292
N14QQF	1245	1350	1413	1448	1482	1514	1547	1580	1613	1645
N14RRF	1097	1180	1229	1257	1283	1308	1335	1360	1386	1412
N15AAYF	1146	1214	1254	1277	1298	1319	1340	1361	1383	1403
N15ARYF	1063	1131	1171	1194	1215	1236	1257	1278	1300	1320
N15CCYF	1301	1369	1409	1432	1453	1474	1495	1516	1538	1558
N15CRYF	1219	1287	1327	1350	1371	1392	1413	1434	1456	1476
N15EEF	1208	1276	1316	1339	1360	1381	1402	1423	1445	1465
N15EESF	1303	1371	1411	1434	1455	1476	1497	1518	1540	1560
N15ERF	1126	1194	1234	1257	1278	1299	1320	1341	1363	1383
N15ERSF	1221	1289	1329	1352	1373	1394	1415	1436	1458	1478
N15GGF	1053	1121	1161	1184	1205	1226	1247	1268	1290	1310
N15GGSF	1148	1216	1256	1279	1300	1321	1342	1363	1385	1405
N15GRF	970	1038	1078	1101	1122	1143	1164	1185	1207	1227
N15GRSF	1065	1133	1173	1196	1217	1238	1259	1280	1302	1322
N15HHF	1319	1387	1427	1450	1471	1492	1513	1534	1556	1576
N15HHSF	1415	1483	1523	1546	1567	1588	1609	1630	1652	1672
N15HRF	1237	1305	1345	1368	1389	1410	1431	1452	1474	1494
N15HRSF	1331	1399	1439	1462	1483	1504	1525	1546	1568	1588
N15JJYEF	1431	1499	1539	1562	1583	1604	1625	1646	1668	1688
N15JJYF	1321	1389	1429	1452	1473	1494	1515	1536	1558	1578
N15JRYEF	1349	1417	1457	1480	1501	1522	1543	1564	1586	1606
N15JRYF	1239	1307	1347	1370	1391	1412	1433	1454	1476	1496

Alliance Program TB133 Fire Rated Pricing

Finishes

IM	Brighton	CW	Cordovan
NM	Natural	DW	Judicial
HN	Honey	MH	Mocha
CL	Caramel	405	Designer White
TF	Truffle	462	Cinder
AC	Autumn	792	Sable
MC	Amber	793	Acorn

To order, specify the following:

1. Chair Model Number
2. Fabric Grade Letter
3. Alliance Pattern Number and Color Number/Name
4. Finish Number (when applicable)

Sample Order Number

<u>N14KKF</u>	<u>A</u>	<u>403901</u>	<u>036</u>	<u>HN</u>
Model Number	Fabric Grade Letter	Alliance Pattern Number	Alliance Color Number	Finish

Model Number

Alliance Program TB133 Price Grades

	A	B	C	D	E	F	G	H	I	J
N15LLF	\$ 954	\$ 975	\$ 993	\$ 1011	\$ 1030	\$ 1051	\$ 1067	\$ 1087	\$ 1110	\$ 1130
N15LLSF	1049	1070	1088	1106	1125	1146	1162	1182	1205	1225
N15LRF	871	892	910	928	947	968	984	1004	1027	1047
N15LRSF	966	987	1005	1023	1042	1063	1079	1099	1122	1142
N15MMEF	1128	1149	1167	1185	1204	1225	1241	1261	1284	1304
N15MMESF	1224	1245	1263	1281	1300	1321	1337	1357	1380	1400
N15MMF	1018	1039	1057	1075	1094	1115	1131	1151	1174	1194
N15MMSF	1114	1135	1153	1171	1190	1211	1227	1247	1270	1290
N15MREF	1045	1066	1084	1102	1121	1142	1158	1178	1201	1221
N15MRESF	1142	1163	1181	1199	1218	1239	1255	1275	1298	1318
N15MRF	935	956	974	992	1011	1032	1048	1068	1091	1111
N15MRSF	1032	1053	1071	1089	1108	1129	1145	1165	1188	1208
N15PPEF	1239	1260	1278	1296	1315	1336	1352	1372	1395	1415
N15PPESF	1334	1355	1373	1391	1410	1431	1447	1467	1490	1510
N15PPF	1128	1149	1167	1185	1204	1225	1241	1261	1284	1304
N15PPSF	1224	1245	1263	1281	1300	1321	1337	1357	1380	1400
N15PREF	1155	1176	1194	1212	1231	1252	1268	1288	1311	1331
N15PRESF	1252	1273	1291	1309	1328	1349	1365	1385	1408	1428
N15PRF	1045	1066	1084	1102	1121	1142	1158	1178	1201	1221
N15PRSF	1142	1163	1181	1199	1218	1239	1255	1275	1298	1318
N15RRF	770	791	809	827	846	867	883	903	926	946
N16CCYF	1185	1206	1224	1242	1261	1282	1298	1318	1341	1361
N16CRYF	1104	1125	1143	1161	1180	1201	1217	1237	1260	1280
N16EEF	1093	1114	1132	1150	1169	1190	1206	1226	1249	1269
N16EESF	1187	1208	1226	1244	1263	1284	1300	1320	1343	1363
N16ERF	1011	1032	1050	1068	1087	1108	1124	1144	1167	1187
N16ERSF	1106	1127	1145	1163	1182	1203	1219	1239	1262	1282
N16HHF	1205	1226	1244	1262	1281	1302	1318	1338	1361	1381
N16HHSF	1297	1318	1336	1354	1373	1394	1410	1430	1453	1473
N16HRF	1121	1142	1160	1178	1197	1218	1234	1254	1277	1297
N16HRSF	1216	1237	1255	1273	1292	1313	1329	1349	1372	1392
N16JJYF	1209	1230	1248	1266	1285	1306	1322	1342	1365	1385
N16JRYF	1126	1147	1165	1183	1202	1223	1239	1259	1282	1302
N16MMF	1114	1135	1153	1171	1190	1211	1227	1247	1270	1290
N16MMSF	1208	1229	1247	1265	1284	1305	1321	1341	1364	1384
N16MRF	1032	1053	1071	1089	1108	1129	1145	1165	1188	1208
N16MRSF	1125	1146	1164	1182	1201	1222	1238	1258	1281	1301
N16PPF	1224	1245	1263	1281	1300	1321	1337	1357	1380	1400
N16PPSF	1318	1339	1357	1375	1394	1415	1431	1451	1474	1494
N16PRF	1142	1163	1181	1199	1218	1239	1255	1275	1298	1318
N16PRSF	1236	1257	1275	1293	1312	1333	1349	1369	1392	1412
N17AAYF	1016	1037	1055	1073	1092	1113	1129	1149	1172	1192
N17ARYF	934	955	973	991	1010	1031	1047	1067	1090	1110
N17CCYF	1267	1288	1306	1324	1343	1364	1380	1400	1423	1443
N17CRYF	1183	1204	1222	1240	1259	1280	1296	1316	1339	1359
N17EEF	1175	1196	1214	1232	1251	1272	1288	1308	1331	1351
N17EESF	1380	1401	1419	1437	1456	1477	1493	1513	1536	1556

Model Number	Alliance Program TB133 Price Grades									
	K	L	M	N	O	P	Q	R	S	T
N15LLF	\$ 1163	\$ 1231	\$ 1271	\$ 1294	\$ 1315	\$ 1336	\$ 1357	\$ 1378	\$ 1400	\$ 1420
N15LLSF	1258	1326	1366	1389	1410	1431	1452	1473	1495	1515
N15LRF	1080	1148	1188	1211	1232	1253	1274	1295	1317	1337
N15LRSF	1175	1243	1283	1306	1327	1348	1369	1390	1412	1432
N15MMEF	1337	1405	1445	1468	1489	1510	1531	1552	1574	1594
N15MMESF	1433	1501	1541	1564	1585	1606	1627	1648	1670	1690
N15MMF	1227	1295	1335	1358	1379	1400	1421	1442	1464	1484
N15MMSF	1323	1391	1431	1454	1475	1496	1517	1538	1560	1580
N15MREF	1254	1322	1362	1385	1406	1427	1448	1469	1491	1511
N15MRESF	1351	1419	1459	1482	1503	1524	1545	1566	1588	1608
N15MRF	1144	1212	1252	1275	1296	1317	1338	1359	1381	1401
N15MRSF	1241	1309	1349	1372	1393	1414	1435	1456	1478	1498
N15PPEF	1448	1516	1556	1579	1600	1621	1642	1663	1685	1705
N15PPESF	1543	1611	1651	1674	1695	1716	1737	1758	1780	1800
N15PPF	1337	1405	1445	1468	1489	1510	1531	1552	1574	1594
N15PPSF	1433	1501	1541	1564	1585	1606	1627	1648	1670	1690
N15PREF	1364	1432	1472	1495	1516	1537	1558	1579	1601	1621
N15PRESF	1461	1529	1569	1592	1613	1634	1655	1676	1698	1718
N15PRF	1254	1322	1362	1385	1406	1427	1448	1469	1491	1511
N15PRSF	1351	1419	1459	1482	1503	1524	1545	1566	1588	1608
N15RRF	979	1047	1087	1110	1131	1152	1173	1194	1216	1236
N16CCYF	1394	1462	1502	1525	1546	1567	1588	1609	1631	1651
N16CRYF	1313	1381	1421	1444	1465	1486	1507	1528	1550	1570
N16EEF	1302	1370	1410	1433	1454	1475	1496	1517	1539	1559
N16EESF	1396	1464	1504	1527	1548	1569	1590	1611	1633	1653
N16ERF	1220	1288	1328	1351	1372	1393	1414	1435	1457	1477
N16ERSF	1315	1383	1423	1446	1467	1488	1509	1530	1552	1572
N16HHF	1414	1482	1522	1545	1566	1587	1608	1629	1651	1671
N16HHSF	1506	1574	1614	1637	1658	1679	1700	1721	1743	1763
N16HRF	1330	1398	1438	1461	1482	1503	1524	1545	1567	1587
N16HRSF	1425	1493	1533	1556	1577	1598	1619	1640	1662	1682
N16JJYF	1418	1486	1526	1549	1570	1591	1612	1633	1655	1675
N16JRYF	1335	1403	1443	1466	1487	1508	1529	1550	1572	1592
N16MMF	1323	1391	1431	1454	1475	1496	1517	1538	1560	1580
N16MMSF	1417	1485	1525	1548	1569	1590	1611	1632	1654	1674
N16MRF	1241	1309	1349	1372	1393	1414	1435	1456	1478	1498
N16MRSF	1334	1402	1442	1465	1486	1507	1528	1549	1571	1591
N16PPF	1433	1501	1541	1564	1585	1606	1627	1648	1670	1690
N16PPSF	1527	1595	1635	1658	1679	1700	1721	1742	1764	1784
N16PRF	1351	1419	1459	1482	1503	1524	1545	1566	1588	1608
N16PRSF	1445	1513	1553	1576	1597	1618	1639	1660	1682	1702
N17AAYF	1225	1293	1333	1356	1377	1398	1419	1440	1462	1482
N17ARYF	1143	1211	1251	1274	1295	1316	1337	1358	1380	1400
N17CCYF	1476	1544	1584	1607	1628	1649	1670	1691	1713	1733
N17CRYF	1392	1460	1500	1523	1544	1565	1586	1607	1629	1649
N17EEF	1384	1452	1492	1515	1536	1557	1578	1599	1621	1641
N17EESF	1589	1657	1697	1720	1741	1762	1783	1804	1826	1846

Alliance Program TB133 Fire Rated Pricing

Finishes

IM	Brighton	CW	Cordovan
NM	Natural	DW	Judicial
HN	Honey	MH	Mocha
CL	Caramel	405	Designer White
TF	Truffle	462	Cinder
AC	Autumn	792	Sable
MC	Amber	793	Acorn

To order, specify the following:

1. Chair Model Number
2. Fabric Grade Letter
3. Alliance Pattern Number and Color Number/Name
4. Finish Number (when applicable)

Sample Order Number

<u>N14KKF</u>	<u>A</u>	<u>403901</u>	<u>036</u>	<u>HN</u>
Model Number	Fabric Grade Letter	Alliance Pattern Number	Alliance Color Number	Finish

Model Number

Alliance Program TB133 Price Grades

	A	B	C	D	E	F	G	H	I	J
N17ERF	\$ 1092	\$ 1113	\$ 1131	\$ 1149	\$ 1168	\$ 1189	\$ 1205	\$ 1225	\$ 1248	\$ 1268
N17ERSF	1295	1316	1334	1352	1371	1392	1408	1428	1451	1471
N17GGF	925	946	964	982	1001	1022	1038	1058	1081	1101
N17GGSF	1019	1040	1058	1076	1095	1116	1132	1152	1175	1195
N17GRF	842	863	881	899	918	939	955	975	998	1018
N17GRSF	936	957	975	993	1012	1033	1049	1069	1092	1112
N17HHF	1285	1306	1324	1342	1361	1382	1398	1418	1441	1461
N17HHSF	1490	1511	1529	1547	1566	1587	1603	1623	1646	1666
N17HRF	1204	1225	1243	1261	1280	1301	1317	1337	1360	1380
N17HRSF	1406	1427	1445	1463	1482	1503	1519	1539	1562	1582
N17JJYF	1290	1311	1329	1347	1366	1387	1403	1423	1446	1466
N17JRYF	1209	1230	1248	1266	1285	1306	1322	1342	1365	1385
N17LLF	1035	1056	1074	1092	1111	1132	1148	1168	1191	1211
N17LLSF	1129	1150	1168	1186	1205	1226	1242	1262	1285	1305
N17LRF	952	973	991	1009	1028	1049	1065	1085	1108	1128
N17LRSF	1046	1067	1085	1103	1122	1143	1159	1179	1202	1222
N17MMF	1197	1218	1236	1254	1273	1294	1310	1330	1353	1373
N17MMSF	1291	1312	1330	1348	1367	1388	1404	1424	1447	1467
N17MRF	1114	1135	1153	1171	1190	1211	1227	1247	1270	1290
N17MRSF	1210	1231	1249	1267	1286	1307	1323	1343	1366	1386
N17PPF	1309	1330	1348	1366	1385	1406	1422	1442	1465	1485
N17PPSF	1401	1422	1440	1458	1477	1498	1514	1534	1557	1577
N17PRF	1224	1245	1263	1281	1300	1321	1337	1357	1380	1400
N17PRSF	1320	1341	1359	1377	1396	1417	1433	1453	1476	1496
N17RRF	841	862	880	898	917	938	954	974	997	1017
N23AACF										
N23AACYF										
N23BBCF										
N23BBCYF										
N23CCCDF										
N23CCCF										
N23CCCYDF										
N23CCCYF										
N23DDCDF										
N23DDCF										
N23EECDF										
N23EECF										
N23EECYDF										
N23EECYF										
N23HHCDF										
N23HHCF										
N23JJCF										
N23KKCF										
N23MMCF										
N23PPCF										
N23RRCF										
N23SSCF										

Model Number	Alliance Program TB133 Price Grades									
	K	L	M	N	O	P	Q	R	S	T
N17ERF	\$ 1301	\$ 1369	\$ 1409	\$ 1432	\$ 1453	\$ 1474	\$ 1495	\$ 1516	\$ 1538	\$ 1558
N17ERSF	1504	1572	1612	1635	1656	1677	1698	1719	1741	1761
N17GGF	1134	1202	1242	1265	1286	1307	1328	1349	1371	1391
N17GGSF	1228	1296	1336	1359	1380	1401	1422	1443	1465	1485
N17GRF	1051	1119	1159	1182	1203	1224	1245	1266	1288	1308
N17GRSF	1145	1213	1253	1276	1297	1318	1339	1360	1382	1402
N17HHF	1494	1562	1602	1625	1646	1667	1688	1709	1731	1751
N17HHSF	1699	1767	1807	1830	1851	1872	1893	1914	1936	1956
N17HRF	1413	1481	1521	1544	1565	1586	1607	1628	1650	1670
N17HRSF	1615	1683	1723	1746	1767	1788	1809	1830	1852	1872
N17JJYF	1499	1567	1607	1630	1651	1672	1693	1714	1736	1756
N17JRYF	1418	1486	1526	1549	1570	1591	1612	1633	1655	1675
N17LLF	1244	1312	1352	1375	1396	1417	1438	1459	1481	1501
N17LLSF	1338	1406	1446	1469	1490	1511	1532	1553	1575	1595
N17LRF	1161	1229	1269	1292	1313	1334	1355	1376	1398	1418
N17LRSF	1255	1323	1363	1386	1407	1428	1449	1470	1492	1512
N17MMF	1406	1474	1514	1537	1558	1579	1600	1621	1643	1663
N17MMSF	1500	1568	1608	1631	1652	1673	1694	1715	1737	1757
N17MRF	1323	1391	1431	1454	1475	1496	1517	1538	1560	1580
N17MRSF	1419	1487	1527	1550	1571	1592	1613	1634	1656	1676
N17PPF	1518	1586	1626	1649	1670	1691	1712	1733	1755	1775
N17PPSF	1610	1678	1718	1741	1762	1783	1804	1825	1847	1867
N17PRF	1433	1501	1541	1564	1585	1606	1627	1648	1670	1690
N17PRSF	1529	1597	1637	1660	1681	1702	1723	1744	1766	1786
N17RRF	1050	1118	1158	1181	1202	1223	1244	1265	1287	1307
N23AACF										
N23AACYF										
N23BBCF										
N23BBCYF										
N23CCCDF										
N23CCCF										
N23CCCYDF										
N23CCCYF										
N23DDCDF										
N23DDCF										
N23EECDF										
N23EECF										
N23EECYDF										
N23EECYF										
N23HHCDF										
N23HHCF										
N23JJCF										
N23KKCF										
N23MMCF										
N23PPCF										
N23RRCF										
N23SSCF										

Alliance Program TB133 Fire Rated Pricing

Finishes

IM	Brighton	CW	Cordovan
NM	Natural	DW	Judicial
HN	Honey	MH	Mocha
CL	Caramel	405	Designer White
TF	Truffle	462	Cinder
AC	Autumn	792	Sable
MC	Amber	793	Acorn

To order, specify the following:

1. Chair Model Number
2. Fabric Grade Letter
3. Alliance Pattern Number and Color Number/Name
4. Finish Number (when applicable)

Sample Order Number

<u>N14KKF</u>	<u>A</u>	<u>403901</u>	<u>036</u>	<u>HN</u>
Model Number	Fabric Grade Letter	Alliance Pattern Number	Alliance Color Number	Finish

Model Number

Alliance Program TB133 Price Grades

	A	B	C	D	E	F	G	H	I	J
N24AACF	\$	\$ 9	\$	\$	\$	\$	\$	\$	\$	\$
N24BBCF										
N24CCCF										
N24CCDF										
N24DDCF										
N24EECF										
N24EECF										
N24HHCF										
N24HHCF										
N24JJCF										
N24KKCF										
N24MMCF										
N24PPCF										
N24RRCF										
N24SSCF										
N25AACF										
N25AACYF										
N25BBCF										
N25BBCYF										
N25CCCF										
N25CCCF										
N25CCXDF										
N25CCXF										
N25CCYDF										
N25CCYF										
N25DDCF										
N25DDCF										
N25DDXDF										
N25DDXF										
N25EECF										
N25EECF										
N25EEYDF										
N25EEYF										
N25HHCF										
N25HHCF										
N25JJCF										
N25KKCF										
N25MMCF										
N25PPCF										
N25RRCF										
N25SSCF										
N26AACF										
N26BBCF										
N26CCCF										
N26CCCF										
N26DDCF										

Model Number	Alliance Program TB133 Price Grades									
	K	L	M	N	O	P	Q	R	S	T
N24AACF	\$	\$	\$	\$	\$	\$	\$	\$	\$	\$
N24BBCF										
N24CCCDF										
N24CCCF										
N24DDCDF										
N24DDCF										
N24EECDF										
N24EECF										
N24HHCDF										
N24HHCF										
N24JJCF										
N24KKCF										
N24MMCF										
N24PPCF										
N24RRCF										
N24SSCF										
N25AACF										
N25AACYF										
N25BBCF										
N25BBCYF										
N25CCCDF										
N25CCCF										
N25CCXDF										
N25CCXF										
N25CCYDF										
N25CCYF										
N25DDCDF										
N25DDCF										
N25DDXDF										
N25DDXF										
N25EECDF										
N25EECF										
N25EEYDF										
N25EEYF										
N25HHCDF										
N25HHCF										
N25JJCF										
N25KKCF										
N25MMCF										
N25PPCF										
N25RRCF										
N25SSCF										
N26AACF										
N26BBCF										
N26CCCDF										
N26CCCF										
N26DDCDF										

Alliance Program TB133 Fire Rated Pricing

Finishes

IM	Brighton	CW	Cordovan
NM	Natural	DW	Judicial
HN	Honey	MH	Mocha
CL	Caramel	405	Designer White
TF	Truffle	462	Cinder
AC	Autumn	792	Sable
MC	Amber	793	Acorn

To order, specify the following:

1. Chair Model Number
2. Fabric Grade Letter
3. Alliance Pattern Number and Color Number/Name
4. Finish Number (when applicable)

Sample Order Number

<u>N14KKF</u>	<u>A</u>	<u>403901</u>	<u>036</u>	<u>HN</u>
Model Number	Fabric Grade Letter	Alliance Pattern Number	Alliance Color Number	Finish

Model Number

Alliance Program TB133 Price Grades

	A	B	C	D	E	F	G	H	I	J
N26DDCF	\$	\$	\$	\$	\$	\$	\$	\$	\$	\$
N26DDCXDF										
N26DDCXF										
N26EECDF										
N26EECF										
N26HHCDF										
N26HHCF										
N26JJCF										
N26KKCF										
N26KKCF										
N26MMCF										
N26PPCF										
N26RRCF										
N26SSCF										
N30GM1UNCF										
N30GM1UNF										
N30GM1UPCF										
N30GM1UPF										
N30GM9UNCF										
N30GM9UNF										
N30GM9UPCF										
N30GM9UPF										
N30GP1UNCF	691	712	730	748	767	788	804	824	847	867
N30GP1UNCXF										
N30GP1UNF	691	712	730	748	767	788	804	824	847	867
N30GP1UNXF										
N30GP1UPCF	666	687	705	723	742	763	779	799	822	842
N30GP1UPCXF										
N30GP1UPF	666	687	705	723	742	763	779	799	822	842
N30GP1UPXF										
N30GP9UNCF	741	762	780	798	817	838	854	874	897	917
N30GP9UNCXF										
N30GP9UNF	741	762	780	798	817	838	854	874	897	917
N30GP9UNXF										
N30GP9UPCF	716	737	755	773	792	813	829	849	872	892
N30GP9UPCXF										
N30GP9UPF	716	737	755	773	792	813	829	849	872	892
N30GP9UPXF										
N30GU1UNCF	741	762	780	798	817	838	854	874	897	917
N30GU1UNCXF										
N30GU1UNF	741	762	780	798	817	838	854	874	897	917
N30GU1UNXF										
N30GU1UPCF	716	737	755	773	792	813	829	849	872	892
N30GU1UPCXF										
N30GU1UPF	716	737	755	773	792	813	829	849	872	892
N30GU1UPXF										

Model Number	Alliance Program TB133 Price Grades									
	K	L	M	N	O	P	Q	R	S	T
N26DDCF	\$	\$	\$	\$	\$	\$	\$	\$	\$	\$
N26DDCXDF										
N26DDCXF										
N26EECDF										
N26EECF										
N26HHCDF										
N26HHCF										
N26JJCF										
N26KKCF										
N26KKCF										
N26MMCF										
N26PPCF										
N26RRCF										
N26SSCF										
N30GM1UNCF										
N30GM1UNF										
N30GM1UPCF										
N30GM1UPF										
N30GM9UNCF										
N30GM9UNF										
N30GM9UPCF										
N30GM9UPF										
N30GP1UNCF	900	968	1008	1031	1052	1073	1094	1115	1137	1157
N30GP1UNCXF										
N30GP1UNF	900	968	1008	1031	1052	1073	1094	1115	1137	1157
N30GP1UNXF										
N30GP1UPCF	875	943	983	1006	1027	1048	1069	1090	1112	1132
N30GP1UPCXF										
N30GP1UPF	875	943	983	1006	1027	1048	1069	1090	1112	1132
N30GP1UPXF										
N30GP9UNCF	950	1018	1058	1081	1102	1123	1144	1165	1187	1207
N30GP9UNCXF										
N30GP9UNF	950	1018	1058	1081	1102	1123	1144	1165	1187	1207
N30GP9UNXF										
N30GP9UPCF	925	993	1033	1056	1077	1098	1119	1140	1162	1182
N30GP9UPCXF										
N30GP9UPF	925	993	1033	1056	1077	1098	1119	1140	1162	1182
N30GP9UPXF										
N30GU1UNCF	950	1018	1058	1081	1102	1123	1144	1165	1187	1207
N30GU1UNCXF										
N30GU1UNF	950	1018	1058	1081	1102	1123	1144	1165	1187	1207
N30GU1UNXF										
N30GU1UPCF	925	993	1033	1056	1077	1098	1119	1140	1162	1182
N30GU1UPCXF										
N30GU1UPF	925	993	1033	1056	1077	1098	1119	1140	1162	1182
N30GU1UPXF										

Alliance Program TB133 Fire Rated Pricing

Finishes

IM	Brighton	CW	Cordovan
NM	Natural	DW	Judicial
HN	Honey	MH	Mocha
CL	Caramel	405	Designer White
TF	Truffle	462	Cinder
AC	Autumn	792	Sable
MC	Amber	793	Acorn

To order, specify the following:

1. Chair Model Number
2. Fabric Grade Letter
3. Alliance Pattern Number and Color Number/Name
4. Finish Number (when applicable)

Sample Order Number

<u>N14KKF</u>	<u>A</u>	<u>403901</u>	<u>036</u>	<u>HN</u>
Model Number	Fabric Grade Letter	Alliance Pattern Number	Alliance Color Number	Finish

Model Number

Alliance Program TB133 Price Grades

	A	B	C	D	E	F	G	H	I	J
N30GU9UNCF	\$ 792	\$ 813	\$ 831	\$ 849	\$ 868	\$ 889	\$ 905	\$ 925	\$ 948	\$ 968
N30GU9UNCXF										
N30GU9UNF	792	813	831	849	868	889	905	925	948	968
N30GU9UNXF										
N30GU9UPCF	767	788	806	824	843	864	880	900	923	943
N30GU9UPCXF										
N30GU9UPF	767	788	806	824	843	864	880	900	923	943
N30GU9UPXF										
N30HM1SNF										
N30HM1SPF										
N30HM1SSNF										
N30HM1SSPF										
N30HM2SNF										
N30HM2SPF										
N30HM2SSNF										
N30HM2SSPF										
N30HM3SNF										
N30HM3SPF										
N30HM3SSNF										
N30HM3SSPF										
N30HM8SNF										
N30HM8SSNF										
N30HM9SNF										
N30HM9SPF										
N30HM9SSNF										
N30HM9SSPF										
N30HML1SNF										
N30HML1SPF										
N30HML1SSNF										
N30HML1SSPF										
N30HML2SNF										
N30HML2SPF										
N30HML2SSNF										
N30HML2SSPF										
N30HML3SNF										
N30HML3SPF										
N30HML3SSNF										
N30HML3SSPF										
N30HML8SNF										
N30HML8SSNF										
N30HML9SNF										
N30HML9SPF										
N30HML9SSNF										
N30HML9SSPF										
N30HP1SNF	1047	1077	1103	1129	1157	1188	1210	1240	1272	1301

Model Number	Alliance Program TB133 Price Grades									
	K	L	M	N	O	P	Q	R	S	T
N30GU9UNCF	\$ 1001	\$ 1069	\$ 1109	\$ 1132	\$ 1153	\$ 1174	\$ 1195	\$ 1216	\$ 1238	\$ 1258
N30GU9UNCXF										
N30GU9UNF	1001	1069	1109	1132	1153	1174	1195	1216	1238	1258
N30GU9UNXF										
N30GU9UPCF	976	1044	1084	1107	1128	1149	1170	1191	1213	1233
N30GU9UPCXF										
N30GU9UPF	976	1044	1084	1107	1128	1149	1170	1191	1213	1233
N30GU9UPXF										
N30HM1SNF										
N30HM1SPF										
N30HM1SSNF										
N30HM1SSPF										
N30HM2SNF										
N30HM2SPF										
N30HM2SSNF										
N30HM2SSPF										
N30HM3SNF										
N30HM3SPF										
N30HM3SSNF										
N30HM3SSPF										
N30HM8SNF										
N30HM8SSNF										
N30HM9SNF										
N30HM9SPF										
N30HM9SSNF										
N30HM9SSPF										
N30HML1SNF										
N30HML1SPF										
N30HML1SSNF										
N30HML1SSPF										
N30HML2SNF										
N30HML2SPF										
N30HML2SSNF										
N30HML2SSPF										
N30HML3SNF										
N30HML3SPF										
N30HML3SSNF										
N30HML3SSPF										
N30HML8SNF										
N30HML8SSNF										
N30HML9SNF										
N30HML9SPF										
N30HML9SSNF										
N30HML9SSPF										
N30HP1SNF	1349	1447	1505	1538	1569	1599	1630	1660	1691	1721

Alliance Program TB133 Fire Rated Pricing

Finishes

IM	Brighton	CW	Cordovan
NM	Natural	DW	Judicial
HN	Honey	MH	Mocha
CL	Caramel	405	Designer White
TF	Truffle	462	Cinder
AC	Autumn	792	Sable
MC	Amber	793	Acorn

To order, specify the following:

1. Chair Model Number
2. Fabric Grade Letter
3. Alliance Pattern Number and Color Number/Name
4. Finish Number (when applicable)

Sample Order Number

<u>N14KKF</u>	<u>A</u>	<u>403901</u>	<u>036</u>	<u>HN</u>
Model Number	Fabric Grade Letter	Alliance Pattern Number	Alliance Color Number	Finish

Model Number

Alliance Program TB133 Price Grades

	A	B	C	D	E	F	G	H	I	J
N30HP1SNXF	\$	\$	\$	\$	\$	\$	\$	\$	\$	\$
N30HP1SPF	946	976	1002	1028	1056	1087	1109	1139	1171	1200
N30HP1SPXF										
N30HP1SSNF	1138	1168	1194	1220	1248	1279	1301	1331	1363	1392
N30HP1SSNXF										
N30HP1SSPF	1037	1067	1093	1119	1147	1178	1200	1230	1262	1291
N30HP1SSPXF										
N30HP2SNF	1148	1178	1204	1230	1258	1289	1311	1341	1373	1402
N30HP2SNXF										
N30HP2SPF	1047	1077	1103	1129	1157	1188	1210	1240	1272	1301
N30HP2SPXF										
N30HP2SSNF	1239	1269	1295	1321	1349	1380	1402	1432	1464	1493
N30HP2SSNXF										
N30HP2SSPF	1138	1168	1194	1220	1248	1279	1301	1331	1363	1392
N30HP2SSPXF										
N30HP3SNF	1198	1228	1254	1280	1308	1339	1361	1391	1423	1452
N30HP3SNXF										
N30HP3SPF	1097	1127	1153	1179	1207	1238	1260	1290	1322	1351
N30HP3SPXF										
N30HP3SSNF	1289	1319	1345	1371	1399	1430	1452	1482	1514	1543
N30HP3SSNXF										
N30HP3SSPF	1188	1218	1244	1270	1298	1329	1351	1381	1413	1442
N30HP3SSPXF										
N30HP8SNF	1299	1329	1355	1381	1409	1440	1462	1492	1524	1553
N30HP8SNXF										
N30HP8SSNF	1390	1420	1446	1472	1500	1531	1553	1583	1615	1644
N30HP8SSNXF										
N30HP9SNF	1097	1127	1153	1179	1207	1238	1260	1290	1322	1351
N30HP9SNXF										
N30HP9SPF	996	1026	1052	1078	1106	1137	1159	1189	1221	1250
N30HP9SPXF										
N30HP9SSNF	1188	1218	1244	1270	1298	1329	1351	1381	1413	1442
N30HP9SSNXF										
N30HP9SSPF	1087	1117	1143	1169	1197	1228	1250	1280	1312	1341
N30HP9SSPXF										
N30HU1SNF	1122	1157	1187	1217	1248	1284	1310	1344	1382	1415
N30HU1SNXF										
N30HU1SPF	1021	1056	1086	1116	1147	1183	1209	1243	1281	1314
N30HU1SPXF										
N30HU1SSNF	1213	1248	1278	1308	1339	1375	1401	1435	1473	1506
N30HU1SSNXF										
N30HU1SSPF	1112	1147	1177	1207	1238	1274	1300	1334	1372	1405
N30HU1SSPXF										
N30HU2SNF	1223	1258	1288	1318	1349	1385	1411	1445	1483	1516
N30HU2SNXF										

Model Number	Alliance Program TB133 Price Grades									
	K	L	M	N	O	P	Q	R	S	T
N30HP1SNXF	\$	\$	\$	\$	\$	\$	\$	\$	\$	\$
N30HP1SPF	1248	1346	1404	1437	1468	1498	1529	1559	1590	1620
N30HP1SPXF										
N30HP1SSNF	1440	1538	1596	1629	1660	1690	1721	1751	1782	1812
N30HP1SSNXF										
N30HP1SSPF	1339	1437	1495	1528	1559	1589	1620	1650	1681	1711
N30HP1SSPXF										
N30HP2SNF	1450	1548	1606	1639	1670	1700	1731	1761	1792	1822
N30HP2SNXF										
N30HP2SPF	1349	1447	1505	1538	1569	1599	1630	1660	1691	1721
N30HP2SPXF										
N30HP2SSNF	1541	1639	1697	1730	1761	1791	1822	1852	1883	1913
N30HP2SSNXF										
N30HP2SSPF	1440	1538	1596	1629	1660	1690	1721	1751	1782	1812
N30HP2SSPXF										
N30HP3SNF	1500	1598	1656	1689	1720	1750	1781	1811	1842	1872
N30HP3SNXF										
N30HP3SPF	1399	1497	1555	1588	1619	1649	1680	1710	1741	1771
N30HP3SPXF										
N30HP3SSNF	1591	1689	1747	1780	1811	1841	1872	1902	1933	1963
N30HP3SSNXF										
N30HP3SSPF	1490	1588	1646	1679	1710	1740	1771	1801	1832	1862
N30HP3SSPXF										
N30HP8SNF	1601	1699	1757	1790	1821	1851	1882	1912	1943	1973
N30HP8SNXF										
N30HP8SSNF	1692	1790	1848	1881	1912	1942	1973	2003	2034	2064
N30HP8SSNXF										
N30HP9SNF	1399	1497	1555	1588	1619	1649	1680	1710	1741	1771
N30HP9SNXF										
N30HP9SPF	1298	1396	1454	1487	1518	1548	1579	1609	1640	1670
N30HP9SPXF										
N30HP9SSNF	1490	1588	1646	1679	1710	1740	1771	1801	1832	1862
N30HP9SSNXF										
N30HP9SSPF	1389	1487	1545	1578	1609	1639	1670	1700	1731	1761
N30HP9SSPXF										
N30HU1SNF	1470	1583	1650	1688	1724	1758	1794	1829	1865	1899
N30HU1SNXF										
N30HU1SPF	1369	1482	1549	1587	1623	1657	1693	1728	1764	1798
N30HU1SPXF										
N30HU1SSNF	1561	1674	1741	1779	1815	1849	1885	1920	1956	1990
N30HU1SSNXF										
N30HU1SSPF	1460	1573	1640	1678	1714	1748	1784	1819	1855	1889
N30HU1SSPXF										
N30HU2SNF	1571	1684	1751	1789	1825	1859	1895	1930	1966	2000
N30HU2SNXF										

Alliance Program TB133 Fire Rated Pricing

Finishes

IM	Brighton	CW	Cordovan
NM	Natural	DW	Judicial
HN	Honey	MH	Mocha
CL	Caramel	405	Designer White
TF	Truffle	462	Cinder
AC	Autumn	792	Sable
MC	Amber	793	Acorn

To order, specify the following:

1. Chair Model Number
2. Fabric Grade Letter
3. Alliance Pattern Number and Color Number/Name
4. Finish Number (when applicable)

Sample Order Number

<u>N14KKF</u>	<u>A</u>	<u>403901</u>	<u>036</u>	<u>HN</u>
Model Number	Fabric Grade Letter	Alliance Pattern Number	Alliance Color Number	Finish

Model Number

Alliance Program TB133 Price Grades

	A	B	C	D	E	F	G	H	I	J
N30HU2SPF	\$ 1122	\$ 1157	\$ 1187	\$ 1217	\$ 1248	\$ 1284	\$ 1310	\$ 1344	\$ 1382	\$ 1415
N30HU2SPXF										
N30HU2SSNF	1314	1349	1379	1409	1440	1476	1502	1536	1574	1607
N30HU2SSNXF										
N30HU2SSPF	1213	1248	1278	1308	1339	1375	1401	1435	1473	1506
N30HU2SSPXF										
N30HU3SNF	1274	1309	1339	1369	1400	1436	1462	1496	1534	1567
N30HU3SNXF										
N30HU3SPF	1173	1208	1238	1268	1299	1335	1361	1395	1433	1466
N30HU3SPXF										
N30HU3SSNF	1365	1400	1430	1460	1491	1527	1553	1587	1625	1658
N30HU3SSNXF										
N30HU3SSPF	1264	1299	1329	1359	1390	1426	1452	1486	1524	1557
N30HU3SSPXF										
N30HU8SNF	1375	1410	1440	1470	1501	1537	1563	1597	1635	1668
N30HU8SNXF										
N30HU8SSNF	1466	1501	1531	1561	1592	1628	1654	1688	1726	1759
N30HU8SSNXF										
N30HU9SNF	1173	1208	1238	1268	1299	1335	1361	1395	1433	1466
N30HU9SNXF										
N30HU9SPF	1072	1107	1137	1167	1198	1234	1260	1294	1332	1365
N30HU9SPXF										
N30HU9SSNF	1264	1299	1329	1359	1390	1426	1452	1486	1524	1557
N30HU9SSNXF										
N30HU9SSPF	1163	1198	1228	1258	1289	1325	1351	1385	1423	1456
N30HU9SSPXF										
N30MP1SNF	990	1017	1041	1065	1090	1119	1140	1167	1197	1224
N30MP1SNXF										
N30MP1SPF	889	916	940	964	989	1018	1039	1066	1096	1123
N30MP1SPXF										
N30MP1SSNF	1081	1108	1132	1156	1181	1210	1231	1258	1288	1315
N30MP1SSNXF										
N30MP1SSPF	980	1007	1031	1055	1080	1109	1130	1157	1187	1214
N30MP1SSPXF										
N30MP2SNF	1091	1118	1142	1166	1191	1220	1241	1268	1298	1325
N30MP2SNXF										
N30MP2SPF	990	1017	1041	1065	1090	1119	1140	1167	1197	1224
N30MP2SPXF										
N30MP2SSNF	1182	1209	1233	1257	1282	1311	1332	1359	1389	1416
N30MP2SSNXF										
N30MP2SSPF	1081	1108	1132	1156	1181	1210	1231	1258	1288	1315
N30MP2SSPXF										
N30MP3SNF	1142	1169	1193	1217	1242	1271	1292	1319	1349	1376
N30MP3SNXF										
N30MP3SPF	1041	1068	1092	1116	1141	1170	1191	1218	1248	1275

Model Number	Alliance Program TB133 Price Grades									
	K	L	M	N	O	P	Q	R	S	T
N30HU2SPF	\$ 1470	\$ 1583	\$ 1650	\$ 1688	\$ 1724	\$ 1758	\$ 1794	\$ 1829	\$ 1865	\$ 1899
N30HU2SPXF										
N30HU2SSNF	1662	1775	1842	1880	1916	1950	1986	2021	2057	2091
N30HU2SSNXF										
N30HU2SSPF	1561	1674	1741	1779	1815	1849	1885	1920	1956	1990
N30HU2SSPXF										
N30HU3SNF	1622	1735	1802	1840	1876	1910	1946	1981	2017	2051
N30HU3SNXF										
N30HU3SPF	1521	1634	1701	1739	1775	1809	1845	1880	1916	1950
N30HU3SPXF										
N30HU3SSNF	1713	1826	1893	1931	1967	2001	2037	2072	2108	2142
N30HU3SSNXF										
N30HU3SSPF	1612	1725	1792	1830	1866	1900	1936	1971	2007	2041
N30HU3SSPXF										
N30HU8SNF	1723	1836	1903	1941	1977	2011	2047	2082	2118	2152
N30HU8SNXF										
N30HU8SSNF	1814	1927	1994	2032	2068	2102	2138	2173	2209	2243
N30HU8SSNXF										
N30HU9SNF	1521	1634	1701	1739	1775	1809	1845	1880	1916	1950
N30HU9SNXF										
N30HU9SPF	1420	1533	1600	1638	1674	1708	1744	1779	1815	1849
N30HU9SPXF										
N30HU9SSNF	1612	1725	1792	1830	1866	1900	1936	1971	2007	2041
N30HU9SSNXF										
N30HU9SSPF	1511	1624	1691	1729	1765	1799	1835	1870	1906	1940
N30HU9SSPXF										
N30MP1SNF	1268	1358	1412	1442	1471	1498	1527	1555	1584	1611
N30MP1SNXF										
N30MP1SPF	1167	1257	1311	1341	1370	1397	1426	1454	1483	1510
N30MP1SPXF										
N30MP1SSNF	1359	1449	1503	1533	1562	1589	1618	1646	1675	1702
N30MP1SSNXF										
N30MP1SSPF	1258	1348	1402	1432	1461	1488	1517	1545	1574	1601
N30MP1SSPXF										
N30MP2SNF	1369	1459	1513	1543	1572	1599	1628	1656	1685	1712
N30MP2SNXF										
N30MP2SPF	1268	1358	1412	1442	1471	1498	1527	1555	1584	1611
N30MP2SPXF										
N30MP2SSNF	1460	1550	1604	1634	1663	1690	1719	1747	1776	1803
N30MP2SSNXF										
N30MP2SSPF	1359	1449	1503	1533	1562	1589	1618	1646	1675	1702
N30MP2SSPXF										
N30MP3SNF	1420	1510	1564	1594	1623	1650	1679	1707	1736	1763
N30MP3SNXF										
N30MP3SPF	1319	1409	1463	1493	1522	1549	1578	1606	1635	1662

Alliance Program TB133 Fire Rated Pricing

Finishes

IM	Brighton	CW	Cordovan
NM	Natural	DW	Judicial
HN	Honey	MH	Mocha
CL	Caramel	405	Designer White
TF	Truffle	462	Cinder
AC	Autumn	792	Sable
MC	Amber	793	Acorn

To order, specify the following:

1. Chair Model Number
2. Fabric Grade Letter
3. Alliance Pattern Number and Color Number/Name
4. Finish Number (when applicable)

Sample Order Number

<u>N14KKF</u>	<u>A</u>	<u>403901</u>	<u>036</u>	<u>HN</u>
Model Number	Fabric Grade Letter	Alliance Pattern Number	Alliance Color Number	Finish

Model Number

Alliance Program TB133 Price Grades

	A	B	C	D	E	F	G	H	I	J
N30MP3SPXF	\$	\$	\$	\$	\$	\$	\$	\$	\$	\$
N30MP3SSNF	1233	1260	1284	1308	1333	1362	1383	1410	1440	1467
N30MP3SSNXF										
N30MP3SSPF	1132	1159	1183	1207	1232	1261	1282	1309	1339	1366
N30MP3SSPXF										
N30MP8SNF	1243	1270	1294	1318	1343	1372	1393	1420	1450	1477
N30MP8SNXF										
N30MP8SSNF	1334	1361	1385	1409	1434	1463	1484	1511	1541	1568
N30MP8SSNXF										
N30MP9SNF	1041	1068	1092	1116	1141	1170	1191	1218	1248	1275
N30MP9SNXF										
N30MP9SPF	940	967	991	1015	1040	1069	1090	1117	1147	1174
N30MP9SPXF										
N30MP9SSNF	1132	1159	1183	1207	1232	1261	1282	1309	1339	1366
N30MP9SSNXF										
N30MP9SSPF	1031	1058	1082	1106	1131	1160	1181	1208	1238	1265
N30MP9SSPXF										
N30MU1SNF	1065	1097	1125	1153	1183	1216	1240	1272	1307	1338
N30MU1SNXF										
N30MU1SPF	964	996	1024	1052	1082	1115	1139	1171	1206	1237
N30MU1SPXF										
N30MU1SSNF	1156	1188	1216	1244	1274	1307	1331	1363	1398	1429
N30MU1SSNXF										
N30MU1SSPF	1055	1087	1115	1143	1173	1206	1230	1262	1297	1328
N30MU1SSPXF										
N30MU2SNF	1166	1198	1226	1254	1284	1317	1341	1373	1408	1439
N30MU2SNXF										
N30MU2SPF	1065	1097	1125	1153	1183	1216	1240	1272	1307	1338
N30MU2SPXF										
N30MU2SSNF	1257	1289	1317	1345	1375	1408	1432	1464	1499	1530
N30MU2SSNXF										
N30MU2SSPF	1156	1188	1216	1244	1274	1307	1331	1363	1398	1429
N30MU2SSPXF										
N30MU3SNF	1216	1248	1276	1304	1334	1367	1391	1423	1458	1489
N30MU3SNXF										
N30MU3SPF	1115	1147	1175	1203	1233	1266	1290	1322	1357	1388
N30MU3SPXF										
N30MU3SSNF	1307	1339	1367	1395	1425	1458	1482	1514	1549	1580
N30MU3SSNXF										
N30MU3SSPF	1206	1238	1266	1294	1324	1357	1381	1413	1448	1479
N30MU3SSPXF										
N30MU8SNF	1317	1349	1377	1405	1435	1468	1492	1524	1559	1590
N30MU8SNXF										
N30MU8SSNF	1408	1440	1468	1496	1526	1559	1583	1615	1650	1681
N30MU8SSNXF										

Model Number	Alliance Program TB133 Price Grades									
	K	L	M	N	O	P	Q	R	S	T
N30MP3SPXF	\$	\$	\$	\$	\$	\$	\$	\$	\$	\$
N30MP3SSNF	1511	1601	1655	1685	1714	1741	1770	1798	1827	1854
N30MP3SSNXF										
N30MP3SSPF	1410	1500	1554	1584	1613	1640	1669	1697	1726	1753
N30MP3SSPXF										
N30MP8SNF	1521	1611	1665	1695	1724	1751	1780	1808	1837	1864
N30MP8SNXF										
N30MP8SSNF	1612	1702	1756	1786	1815	1842	1871	1899	1928	1955
N30MP8SSNXF										
N30MP9SNF	1319	1409	1463	1493	1522	1549	1578	1606	1635	1662
N30MP9SNXF										
N30MP9SPF	1218	1308	1362	1392	1421	1448	1477	1505	1534	1561
N30MP9SPXF										
N30MP9SSNF	1410	1500	1554	1584	1613	1640	1669	1697	1726	1753
N30MP9SSNXF										
N30MP9SSPF	1309	1399	1453	1483	1512	1539	1568	1596	1625	1652
N30MP9SSPXF										
N30MU1SNF	1390	1495	1558	1593	1627	1659	1692	1725	1758	1790
N30MU1SNXF										
N30MU1SPF	1289	1394	1457	1492	1526	1558	1591	1624	1657	1689
N30MU1SPXF										
N30MU1SSNF	1481	1586	1649	1684	1718	1750	1783	1816	1849	1881
N30MU1SSNXF										
N30MU1SSPF	1380	1485	1548	1583	1617	1649	1682	1715	1748	1780
N30MU1SSPXF										
N30MU2SNF	1491	1596	1659	1694	1728	1760	1793	1826	1859	1891
N30MU2SNXF										
N30MU2SPF	1390	1495	1558	1593	1627	1659	1692	1725	1758	1790
N30MU2SPXF										
N30MU2SSNF	1582	1687	1750	1785	1819	1851	1884	1917	1950	1982
N30MU2SSNXF										
N30MU2SSPF	1481	1586	1649	1684	1718	1750	1783	1816	1849	1881
N30MU2SSPXF										
N30MU3SNF	1541	1646	1709	1744	1778	1810	1843	1876	1909	1941
N30MU3SNXF										
N30MU3SPF	1440	1545	1608	1643	1677	1709	1742	1775	1808	1840
N30MU3SPXF										
N30MU3SSNF	1632	1737	1800	1835	1869	1901	1934	1967	2000	2032
N30MU3SSNXF										
N30MU3SSPF	1531	1636	1699	1734	1768	1800	1833	1866	1899	1931
N30MU3SSPXF										
N30MU8SNF	1642	1747	1810	1845	1879	1911	1944	1977	2010	2042
N30MU8SNXF										
N30MU8SSNF	1733	1838	1901	1936	1970	2002	2035	2068	2101	2133
N30MU8SSNXF										

Alliance Program TB133 Fire Rated Pricing

Finishes

IM	Brighton	CW	Cordovan
NM	Natural	DW	Judicial
HN	Honey	MH	Mocha
CL	Caramel	405	Designer White
TF	Truffle	462	Cinder
AC	Autumn	792	Sable
MC	Amber	793	Acorn

To order, specify the following:

1. Chair Model Number
2. Fabric Grade Letter
3. Alliance Pattern Number and Color Number/Name
4. Finish Number (when applicable)

Sample Order Number

<u>N14KKF</u>	<u>A</u>	<u>403901</u>	<u>036</u>	<u>HN</u>
Model Number	Fabric Grade Letter	Alliance Pattern Number	Alliance Color Number	Finish

Model Number

Alliance Program TB133 Price Grades

	A	B	C	D	E	F	G	H	I	J
N30MU9SNF	\$ 1115	\$ 1147	\$ 1175	\$ 1203	\$ 1233	\$ 1266	\$ 1290	\$ 1322	\$ 1357	\$ 1388
N30MU9SNXF										
N30MU9SPF	1014	1046	1074	1102	1132	1165	1189	1221	1256	1287
N30MU9SPXF										
N30MU9SSNF	1206	1238	1266	1294	1324	1357	1381	1413	1448	1479
N30MU9SSNXF										
N30MU9SSPF	1105	1137	1165	1193	1223	1256	1280	1312	1347	1378
N30MU9SSPXF										
N30SP1SNF	1016	1043	1067	1091	1116	1145	1166	1193	1223	1250
N30SP1SNGF	1016	1043	1067	1091	1116	1145	1166	1193	1223	1250
N30SP1SNGXF										
N30SP1SNXF										
N30SP1SPF	915	942	966	990	1015	1044	1065	1092	1122	1149
N30SP1SPGF	915	942	966	990	1015	1044	1065	1092	1122	1149
N30SP1SPGXF										
N30SP1SPXF										
N30SP2SNF	1117	1144	1168	1192	1217	1246	1267	1294	1324	1351
N30SP2SNGF	1117	1144	1168	1192	1217	1246	1267	1294	1324	1351
N30SP2SNGXF										
N30SP2SNXF										
N30SP2SPF	1016	1043	1067	1091	1116	1145	1166	1193	1223	1250
N30SP2SPGF	1016	1043	1067	1091	1116	1145	1166	1193	1223	1250
N30SP2SPGXF										
N30SP2SPXF										
N30SP3SNF	1167	1194	1218	1242	1267	1296	1317	1344	1374	1401
N30SP3SNGF	1167	1194	1218	1242	1267	1296	1317	1344	1374	1401
N30SP3SNGXF										
N30SP3SNXF										
N30SP3SPF	1066	1093	1117	1141	1166	1195	1216	1243	1273	1300
N30SP3SPGF	1066	1093	1117	1141	1166	1195	1216	1243	1273	1300
N30SP3SPGXF										
N30SP3SPXF										
N30SP8SNF	1268	1295	1319	1343	1368	1397	1418	1445	1475	1502
N30SP8SNGF	1268	1295	1319	1343	1368	1397	1418	1445	1475	1502
N30SP8SNGXF										
N30SP8SNXF										
N30SP9SNF	1066	1093	1117	1141	1166	1195	1216	1243	1273	1300
N30SP9SNGF	1066	1093	1117	1141	1166	1195	1216	1243	1273	1300
N30SP9SNGXF										
N30SP9SNXF										
N30SP9SPF	965	992	1016	1040	1065	1094	1115	1142	1172	1199
N30SP9SPGF	965	992	1016	1040	1065	1094	1115	1142	1172	1199
N30SP9SPGXF										
N30SP9SPXF										
N30SU1SNF	1115	1147	1175	1203	1233	1266	1290	1322	1357	1388

Model Number	Alliance Program TB133 Price Grades									
	K	L	M	N	O	P	Q	R	S	T
N30MU9SNF	\$ 1440	\$ 1545	\$ 1608	\$ 1643	\$ 1677	\$ 1709	\$ 1742	\$ 1775	\$ 1808	\$ 1840
N30MU9SNXF										
N30MU9SPF	1339	1444	1507	1542	1576	1608	1641	1674	1707	1739
N30MU9SPXF										
N30MU9SSNF	1531	1636	1699	1734	1768	1800	1833	1866	1899	1931
N30MU9SSNXF										
N30MU9SSPF	1430	1535	1598	1633	1667	1699	1732	1765	1798	1830
N30MU9SSPXF										
N30SP1SNF	1294	1384	1438	1468	1497	1524	1553	1581	1610	1637
N30SP1SNGF	1294	1384	1438	1468	1497	1524	1553	1581	1610	1637
N30SP1SNGXF										
N30SP1SNXF										
N30SP1SPF	1193	1283	1337	1367	1396	1423	1452	1480	1509	1536
N30SP1SPGF	1193	1283	1337	1367	1396	1423	1452	1480	1509	1536
N30SP1SPGXF										
N30SP1SPXF										
N30SP2SNF	1395	1485	1539	1569	1598	1625	1654	1682	1711	1738
N30SP2SNGF	1395	1485	1539	1569	1598	1625	1654	1682	1711	1738
N30SP2SNGXF										
N30SP2SNXF										
N30SP2SPF	1294	1384	1438	1468	1497	1524	1553	1581	1610	1637
N30SP2SPGF	1294	1384	1438	1468	1497	1524	1553	1581	1610	1637
N30SP2SPGXF										
N30SP2SPXF										
N30SP3SNF	1445	1535	1589	1619	1648	1675	1704	1732	1761	1788
N30SP3SNGF	1445	1535	1589	1619	1648	1675	1704	1732	1761	1788
N30SP3SNGXF										
N30SP3SNXF										
N30SP3SPF	1344	1434	1488	1518	1547	1574	1603	1631	1660	1687
N30SP3SPGF	1344	1434	1488	1518	1547	1574	1603	1631	1660	1687
N30SP3SPGXF										
N30SP3SPXF										
N30SP8SNF	1546	1636	1690	1720	1749	1776	1805	1833	1862	1889
N30SP8SNGF	1546	1636	1690	1720	1749	1776	1805	1833	1862	1889
N30SP8SNGXF										
N30SP8SNXF										
N30SP9SNF	1344	1434	1488	1518	1547	1574	1603	1631	1660	1687
N30SP9SNGF	1344	1434	1488	1518	1547	1574	1603	1631	1660	1687
N30SP9SNGXF										
N30SP9SNXF										
N30SP9SPF	1243	1333	1387	1417	1446	1473	1502	1530	1559	1586
N30SP9SPGF	1243	1333	1387	1417	1446	1473	1502	1530	1559	1586
N30SP9SPGXF										
N30SP9SPXF										
N30SU1SNF	1440	1545	1608	1643	1677	1709	1742	1775	1808	1840

Alliance Program TB133 Fire Rated Pricing

Finishes

IM	Brighton	CW	Cordovan
NM	Natural	DW	Judicial
HN	Honey	MH	Mocha
CL	Caramel	405	Designer White
TF	Truffle	462	Cinder
AC	Autumn	792	Sable
MC	Amber	793	Acorn

To order, specify the following:

1. Chair Model Number
2. Fabric Grade Letter
3. Alliance Pattern Number and Color Number/Name
4. Finish Number (when applicable)

Sample Order Number

<u>N14KKF</u>	<u>A</u>	<u>403901</u>	<u>036</u>	<u>HN</u>
Model Number	Fabric Grade Letter	Alliance Pattern Number	Alliance Color Number	Finish

Model Number

Alliance Program TB133 Price Grades

	A	B	C	D	E	F	G	H	I	J
N30SU1SNGF	\$ 1115	\$ 1147	\$ 1175	\$ 1203	\$ 1233	\$ 1266	\$ 1290	\$ 1322	\$ 1357	\$ 1388
N30SU1SNGXF										
N30SU1SNXF										
N30SU1SPF	1014	1046	1074	1102	1132	1165	1189	1221	1256	1287
N30SU1SPGF	1014	1046	1074	1102	1132	1165	1189	1221	1256	1287
N30SU1SPGXF										
N30SU1SPXF										
N30SU2SNF	1216	1248	1276	1304	1334	1367	1391	1423	1458	1489
N30SU2SNGF	1216	1248	1276	1304	1334	1367	1391	1423	1458	1489
N30SU2SNGXF										
N30SU2SNXF										
N30SU2SPF	1115	1147	1175	1203	1233	1266	1290	1322	1357	1388
N30SU2SPGF	1115	1147	1175	1203	1233	1266	1290	1322	1357	1388
N30SU2SPGXF										
N30SU2SPXF										
N30SU3SNF	1267	1299	1327	1355	1385	1418	1442	1474	1509	1540
N30SU3SNGF	1267	1299	1327	1355	1385	1418	1442	1474	1509	1540
N30SU3SNGXF										
N30SU3SNXF										
N30SU3SPF	1166	1198	1226	1254	1284	1317	1341	1373	1408	1439
N30SU3SPGF	1166	1198	1226	1254	1284	1317	1341	1373	1408	1439
N30SU3SPGXF										
N30SU3SPXF										
N30SU8SNF	1368	1400	1428	1456	1486	1519	1543	1575	1610	1641
N30SU8SNGF	1368	1400	1428	1456	1486	1519	1543	1575	1610	1641
N30SU8SNGXF										
N30SU8SNXF										
N30SU9SNF	1166	1198	1226	1254	1284	1317	1341	1373	1408	1439
N30SU9SNGF	1166	1198	1226	1254	1284	1317	1341	1373	1408	1439
N30SU9SNGXF										
N30SU9SNXF										
N30SU9SPF	1065	1097	1125	1153	1183	1216	1240	1272	1307	1338
N30SU9SPGF	1065	1097	1125	1153	1183	1216	1240	1272	1307	1338
N30SU9SPGXF										
N30SU9SPXF										
N32AAMF	2174	2287	2385	2483	2586	2703	2787	2899	3022	3130
N32AAMSF	2273	2388	2488	2588	2693	2813	2898	3013	3138	3248
N32AAWF	2290	2403	2501	2599	2702	2819	2903	3015	3138	3246
N32AAWSF	2390	2505	2605	2705	2810	2930	3015	3130	3255	3365
N32BBMF	2321	2434	2532	2630	2733	2850	2934	3046	3169	3277
N32BBMSF	2390	2505	2605	2705	2810	2930	3015	3130	3255	3365
N32BBWF	2439	2552	2650	2748	2851	2968	3052	3164	3287	3395
N32BBWSF	2538	2653	2753	2853	2958	3078	3163	3278	3403	3513
N32CCMLF	2546	2659	2757	2855	2958	3075	3159	3271	3394	3502
N32CCLSF	2646	2761	2861	2961	3066	3186	3271	3386	3511	3621
N32CCMRF	2546	2659	2757	2855	2958	3075	3159	3271	3394	3502

Model Number	Alliance Program TB133 Price Grades									
	K	L	M	N	O	P	Q	R	S	T
N30SU1SNGF	\$ 1440	\$ 1545	\$ 1608	\$ 1643	\$ 1677	\$ 1709	\$ 1742	\$ 1775	\$ 1808	\$ 1840
N30SU1SNGXF										
N30SU1SNXF										
N30SU1SPF	1339	1444	1507	1542	1576	1608	1641	1674	1707	1739
N30SU1SPGF	1339	1444	1507	1542	1576	1608	1641	1674	1707	1739
N30SU1SPGXF										
N30SU1SPXF										
N30SU2SNF	1541	1646	1709	1744	1778	1810	1843	1876	1909	1941
N30SU2SNGF	1541	1646	1709	1744	1778	1810	1843	1876	1909	1941
N30SU2SNGXF										
N30SU2SNXF										
N30SU2SPF	1440	1545	1608	1643	1677	1709	1742	1775	1808	1840
N30SU2SPGF	1440	1545	1608	1643	1677	1709	1742	1775	1808	1840
N30SU2SPGXF										
N30SU2SPXF										
N30SU3SNF	1592	1697	1760	1795	1829	1861	1894	1927	1960	1992
N30SU3SNGF	1592	1697	1760	1795	1829	1861	1894	1927	1960	1992
N30SU3SNGXF										
N30SU3SNXF										
N30SU3SPF	1491	1596	1659	1694	1728	1760	1793	1826	1859	1891
N30SU3SPGF	1491	1596	1659	1694	1728	1760	1793	1826	1859	1891
N30SU3SPGXF										
N30SU3SPXF										
N30SU8SNF	1693	1798	1861	1896	1930	1962	1995	2028	2061	2093
N30SU8SNGF	1693	1798	1861	1896	1930	1962	1995	2028	2061	2093
N30SU8SNGXF										
N30SU8SNXF										
N30SU9SNF	1491	1596	1659	1694	1728	1760	1793	1826	1859	1891
N30SU9SNGF	1491	1596	1659	1694	1728	1760	1793	1826	1859	1891
N30SU9SNGXF										
N30SU9SNXF										
N30SU9SPF	1390	1495	1558	1593	1627	1659	1692	1725	1758	1790
N30SU9SPGF	1390	1495	1558	1593	1627	1659	1692	1725	1758	1790
N30SU9SPGXF										
N30SU9SPXF										
N32AAMF	3311	3679	3899	4022	4139	4252	4369	4482	4600	4712
N32AAMSF	3433	3808	4033	4158	4278	4393	4513	4628	4748	4863
N32AAWF	3427	3795	4015	4138	4255	4368	4485	4598	4716	4828
N32AAWSF	3550	3925	4150	4275	4395	4510	4630	4745	4865	4980
N32BBMF	3458	3826	4046	4169	4286	4399	4516	4629	4747	4859
N32BBMSF	3550	3925	4150	4275	4395	4510	4630	4745	4865	4980
N32BBWF	3576	3944	4164	4287	4404	4517	4634	4747	4865	4977
N32BBWSF	3698	4073	4298	4423	4543	4658	4778	4893	5013	5128
N32CCMLF	3683	4051	4271	4394	4511	4624	4741	4854	4972	5084
N32CCMSF	3806	4181	4406	4531	4651	4766	4886	5001	5121	5236
N32CCMRF	3683	4051	4271	4394	4511	4624	4741	4854	4972	5084

Alliance Program TB133 Fire Rated Pricing

Finishes

IM	Brighton	CW	Cordovan
NM	Natural	DW	Judicial
HN	Honey	MH	Mocha
CL	Caramel	405	Designer White
TF	Truffle	462	Cinder
AC	Autumn	792	Sable
MC	Amber	793	Acorn

To order, specify the following:

1. Chair Model Number
2. Fabric Grade Letter
3. Alliance Pattern Number and Color Number/Name
4. Finish Number (when applicable)

Sample Order Number

<u>N14KKF</u>	<u>A</u>	<u>403901</u>	<u>036</u>	<u>HN</u>
Model Number	Fabric Grade Letter	Alliance Pattern Number	Alliance Color Number	Finish

Model Number

Alliance Program TB133 Price Grades

	A	B	C	D	E	F	G	H	I	J
N32CCMRSF	\$ 2646	\$ 2761	\$ 2861	\$ 2961	\$ 3066	\$ 3186	\$ 3271	\$ 3386	\$ 3511	\$ 3621
N32CCWLF	2663	2776	2874	2972	3075	3192	3276	3388	3511	3619
N32CCWLSF	2763	2878	2978	3078	3183	3303	3388	3503	3628	3738
N32CCWRF	2663	2776	2874	2972	3075	3192	3276	3388	3511	3619
N32CCWRSF	2763	2878	2978	3078	3183	3303	3388	3503	3628	3738
N32DDMLF	2681	2794	2892	2990	3093	3210	3294	3406	3529	3637
N32DDMSF	2780	2895	2995	3095	3200	3320	3405	3520	3645	3755
N32DDMRF	2681	2794	2892	2990	3093	3210	3294	3406	3529	3637
N32DDMRSF	2780	2895	2995	3095	3200	3320	3405	3520	3645	3755
N32DDWLF	2797	2910	3008	3106	3209	3326	3410	3522	3645	3753
N32DDWLSF	2898	3013	3113	3213	3318	3438	3523	3638	3763	3873
N32DDWRF	2797	2910	3008	3106	3209	3326	3410	3522	3645	3753
N32DDWRSF	2898	3013	3113	3213	3318	3438	3523	3638	3763	3873
N32HHMF	3197	3404	3584	3764	3953	4169	4322	4529	4754	4952
N32HHMSF	3419	3651	3853	4055	4267	4510	4681	4914	5166	5388
N32HHWF	3315	3522	3702	3882	4071	4287	4440	4647	4872	5070
N32HHWSF	3535	3767	3969	4171	4383	4626	4797	5030	5282	5504
N32HKMF	1768	1846	1914	1982	2054	2135	2193	2271	2356	2431
N32HKWF	1887	1965	2033	2101	2173	2254	2312	2390	2475	2550
N32JJMBF	3941	4148	4328	4508	4697	4913	5066	5273	5498	5696
N32JJMBSF	4162	4394	4596	4798	5010	5253	5424	5657	5909	6131
N32JJMLF	3569	3776	3956	4136	4325	4541	4694	4901	5126	5324
N32JJMSF	3789	4021	4223	4425	4637	4880	5051	5284	5536	5758
N32JJMRF	3569	3776	3956	4136	4325	4541	4694	4901	5126	5324
N32JJMRSF	3789	4021	4223	4425	4637	4880	5051	5284	5536	5758
N32JJWBF	4058	4265	4445	4625	4814	5030	5183	5390	5615	5813
N32JJWBSF	4280	4512	4714	4916	5128	5371	5542	5775	6027	6249
N32JJWLF	3685	3892	4072	4252	4441	4657	4810	5017	5242	5440
N32JJWLSF	3907	4139	4341	4543	4755	4998	5169	5402	5654	5876
N32JJWRF	3685	3892	4072	4252	4441	4657	4810	5017	5242	5440
N32JJWRSF	3907	4139	4341	4543	4755	4998	5169	5402	5654	5876
N32KKCF	972	1003	1030	1057	1086	1118	1141	1172	1206	1236
N32KKMF	780	811	838	865	894	926	949	980	1014	1044
N32KKWF	898	929	956	983	1012	1044	1067	1098	1132	1162
N32LKMf	1991	2064	2128	2192	2259	2336	2391	2464	2544	2615
N32LKWF	2109	2182	2246	2310	2377	2454	2509	2582	2662	2733
N32LLMF	3708	3913	4091	4269	4456	4669	4821	5025	5248	5444
N32LLMSF	3894	4117	4311	4505	4708	4941	5106	5329	5572	5785
N32LLWF	3825	4030	4208	4386	4573	4786	4938	5142	5365	5561
N32LLWSF	4011	4234	4428	4622	4825	5058	5223	5446	5689	5902
N32MAAMF	1807	1872	1928	1984	2043	2110	2157	2222	2292	2353
N32MAAWF	1924	1989	2045	2101	2160	2227	2274	2339	2409	2470
N32MBBMF	1955	2020	2076	2132	2191	2258	2305	2370	2440	2501
N32MBBWF	2072	2137	2193	2249	2308	2375	2422	2487	2557	2618
N32MHHMF	2795	2947	3079	3211	3349	3508	3620	3772	3937	4082
N32MHHWF	2912	3064	3196	3328	3466	3625	3737	3889	4054	4199
N32MLLMF	3209	3340	3454	3568	3687	3824	3921	4052	4195	4320

Model Number	Alliance Program TB133 Price Grades									
	K	L	M	N	O	P	Q	R	S	T
N32CCMRSF	\$ 3806	\$ 4181	\$ 4406	\$ 4531	\$ 4651	\$ 4766	\$ 4886	\$ 5001	\$ 5121	\$ 5236
N32CCWLF	3800	4168	4388	4511	4628	4741	4858	4971	5089	5201
N32CCWLSF	3923	4298	4523	4648	4768	4883	5003	5118	5238	5353
N32CCWRF	3800	4168	4388	4511	4628	4741	4858	4971	5089	5201
N32CCWRSF	3923	4298	4523	4648	4768	4883	5003	5118	5238	5353
N32DDMLF	3818	4186	4406	4529	4646	4759	4876	4989	5107	5219
N32DDMLSF	3940	4315	4540	4665	4785	4900	5020	5135	5255	5370
N32DDMRF	3818	4186	4406	4529	4646	4759	4876	4989	5107	5219
N32DDMRSF	3940	4315	4540	4665	4785	4900	5020	5135	5255	5370
N32DDWLF	3934	4302	4522	4645	4762	4875	4992	5105	5223	5335
N32DDWLSF	4058	4433	4658	4783	4903	5018	5138	5253	5373	5488
N32DDWRF	3934	4302	4522	4645	4762	4875	4992	5105	5223	5335
N32DDWRSF	4058	4433	4658	4783	4903	5018	5138	5253	5373	5488
N32HHMF	5285	5960	6365	6590	6806	7013	7229	7436	7652	7859
N32HHMSF	5762	6520	6974	7227	7469	7701	7944	8176	8418	8651
N32HHWF	5403	6078	6483	6708	6924	7131	7347	7554	7770	7977
N32HHWSF	5878	6636	7090	7343	7585	7817	8060	8292	8534	8767
N32HKMF	2557	2812	2965	3050	3132	3210	3291	3370	3451	3529
N32HKWF	2676	2931	3084	3169	3251	3329	3410	3489	3570	3648
N32JJMBF	6029	6704	7109	7334	7550	7757	7973	8180	8396	8603
N32JJMBSF	6505	7263	7717	7970	8212	8444	8687	8919	9161	9394
N32JJMLF	5657	6332	6737	6962	7178	7385	7601	7808	8024	8231
N32JJMLSF	6132	6890	7344	7597	7839	8071	8314	8546	8788	9021
N32JJMRF	5657	6332	6737	6962	7178	7385	7601	7808	8024	8231
N32JJMRSF	6132	6890	7344	7597	7839	8071	8314	8546	8788	9021
N32JJWBF	6146	6821	7226	7451	7667	7874	8090	8297	8513	8720
N32JJWBSF	6623	7381	7835	8088	8330	8562	8805	9037	9279	9512
N32JJWLF	5773	6448	6853	7078	7294	7501	7717	7924	8140	8347
N32JJWLSF	6250	7008	7462	7715	7957	8189	8432	8664	8906	9139
N32JJWRF	5773	6448	6853	7078	7294	7501	7717	7924	8140	8347
N32JJWRSF	6250	7008	7462	7715	7957	8189	8432	8664	8906	9139
N32KKCF	1286	1387	1448	1481	1514	1545	1577	1608	1641	1672
N32KKMF	1094	1195	1256	1289	1322	1353	1385	1416	1449	1480
N32KKWF	1212	1313	1374	1407	1440	1471	1503	1534	1567	1598
N32LKMf	2733	2973	3117	3197	3274	3347	3424	3498	3575	3648
N32LKWF	2851	3091	3235	3315	3392	3465	3542	3616	3693	3766
N32LLMF	5773	6441	6841	7064	7277	7482	7695	7900	8114	8318
N32LLMSF	6144	6872	7308	7551	7783	8006	8239	8462	8695	8918
N32LLWF	5890	6558	6958	7181	7394	7599	7812	8017	8231	8435
N32LLWSF	6261	6989	7425	7668	7900	8123	8356	8579	8812	9035
N32MAAMF	2457	2667	2793	2863	2930	2995	3062	3126	3193	3258
N32MAAWF	2574	2784	2910	2980	3047	3112	3179	3243	3310	3375
N32MBSMF	2605	2815	2941	3011	3078	3143	3210	3274	3341	3406
N32MBSWF	2722	2932	3058	3128	3195	3260	3327	3391	3458	3523
N32MHHMF	4326	4821	5118	5283	5441	5593	5752	5903	6062	6214
N32MHHWF	4443	4938	5235	5400	5558	5710	5869	6020	6179	6331
N32MLLMF	4531	4959	5215	5358	5494	5625	5762	5893	6030	6161

Alliance Program TB133 Fire Rated Pricing

Finishes

IM	Brighton	CW	Cordovan
NM	Natural	DW	Judicial
HN	Honey	MH	Mocha
CL	Caramel	405	Designer White
TF	Truffle	462	Cinder
AC	Autumn	792	Sable
MC	Amber	793	Acorn

To order, specify the following:

1. Chair Model Number
2. Fabric Grade Letter
3. Alliance Pattern Number and Color Number/Name
4. Finish Number (when applicable)

Sample Order Number

<u>N14KKF</u>	<u>A</u>	<u>403901</u>	<u>036</u>	<u>HN</u>
Model Number	Fabric Grade Letter	Alliance Pattern Number	Alliance Color Number	Finish

Model Number

Alliance Program TB133 Price Grades

	A	B	C	D	E	F	G	H	I	J
N32MLLWF	\$ 3326	\$ 3457	\$ 3571	\$ 3685	\$ 3804	\$ 3941	\$ 4038	\$ 4169	\$ 4312	\$ 4437
N32MMMBF	4452	4657	4835	5013	5200	5413	5565	5769	5992	6188
N32MMMBSF	4639	4862	5056	5250	5453	5686	5851	6074	6317	6530
N32MMMLF	4080	4285	4463	4641	4828	5041	5193	5397	5620	5816
N32MMLSF	4266	4489	4683	4877	5080	5313	5478	5701	5944	6157
N32MMRWF	4080	4285	4463	4641	4828	5041	5193	5397	5620	5816
N32MMRFSF	4266	4489	4683	4877	5080	5313	5478	5701	5944	6157
N32MMWBF	4570	4775	4953	5131	5318	5531	5683	5887	6110	6306
N32MMWBSF	4755	4978	5172	5366	5569	5802	5967	6190	6433	6646
N32MMWLF	4197	4402	4580	4758	4945	5158	5310	5514	5737	5933
N32MMWLSF	4382	4605	4799	4993	5196	5429	5594	5817	6060	6273
N32MMWRF	4197	4402	4580	4758	4945	5158	5310	5514	5737	5933
N32MMWRSF	4382	4605	4799	4993	5196	5429	5594	5817	6060	6273
N32SAAMF	2174	2287	2385	2483	2586	2703	2787	2899	3022	3130
N32SAAMSF	2273	2388	2488	2588	2693	2813	2898	3013	3138	3248
N32SAAWF	2290	2403	2501	2599	2702	2819	2903	3015	3138	3246
N32SAAWSF	2390	2505	2605	2705	2810	2930	3015	3130	3255	3365
N32SBBMF	2321	2434	2532	2630	2733	2850	2934	3046	3169	3277
N32SBBMSF	2390	2505	2605	2705	2810	2930	3015	3130	3255	3365
N32SBBWF	2439	2552	2650	2748	2851	2968	3052	3164	3287	3395
N32SBBWSF	2538	2653	2753	2853	2958	3078	3163	3278	3403	3513
N32SCCMLF	2546	2659	2757	2855	2958	3075	3159	3271	3394	3502
N32SCCMLSF	2646	2761	2861	2961	3066	3186	3271	3386	3511	3621
N32SCCMRF	2546	2659	2757	2855	2958	3075	3159	3271	3394	3502
N32SCCMRSF	2646	2761	2861	2961	3066	3186	3271	3386	3511	3621
N32SCCWLF	2663	2776	2874	2972	3075	3192	3276	3388	3511	3619
N32SCCWLSF	2763	2878	2978	3078	3183	3303	3388	3503	3628	3738
N32SCCWRF	2663	2776	2874	2972	3075	3192	3276	3388	3511	3619
N32SCCWRSF	2763	2878	2978	3078	3183	3303	3388	3503	3628	3738
N32SDDMLF	2681	2794	2892	2990	3093	3210	3294	3406	3529	3637
N32SDDMSF	2780	2895	2995	3095	3200	3320	3405	3520	3645	3755
N32SDDMRWF	2681	2794	2892	2990	3093	3210	3294	3406	3529	3637
N32SDDMRSF	2780	2895	2995	3095	3200	3320	3405	3520	3645	3755
N32SDDWLF	2797	2910	3008	3106	3209	3326	3410	3522	3645	3753
N32SDDWLSF	2898	3013	3113	3213	3318	3438	3523	3638	3763	3873
N32SDDWRF	2797	2910	3008	3106	3209	3326	3410	3522	3645	3753
N32SDDWRSF	2898	3013	3113	3213	3318	3438	3523	3638	3763	3873
N32SHHMF	3197	3404	3584	3764	3953	4169	4322	4529	4754	4952
N32SHHMSF	3419	3651	3853	4055	4267	4510	4681	4914	5166	5388
N32SHHWF	3315	3522	3702	3882	4071	4287	4440	4647	4872	5070
N32SHHWSF	3535	3767	3969	4171	4383	4626	4797	5030	5282	5504
N32SJJMBF	3941	4148	4328	4508	4697	4913	5066	5273	5498	5696
N32SJJMBSF	4162	4394	4596	4798	5010	5253	5424	5657	5909	6131
N32SJJMLF	3569	3776	3956	4136	4325	4541	4694	4901	5126	5324
N32SJJMSF	3789	4021	4223	4425	4637	4880	5051	5284	5536	5758
N32SJJMRWF	3569	3776	3956	4136	4325	4541	4694	4901	5126	5324
N32SJJMRSF	3789	4021	4223	4425	4637	4880	5051	5284	5536	5758

Model Number	Alliance Program TB133 Price Grades									
	K	L	M	N	O	P	Q	R	S	T
N32MLLWF	\$ 4648	\$ 5076	\$ 5332	\$ 5475	\$ 5611	\$ 5742	\$ 5879	\$ 6010	\$ 6147	\$ 6278
N32MMMBF	6517	7185	7585	7808	8021	8226	8439	8644	8858	9062
N32MMMBSF	6889	7617	8053	8296	8528	8751	8984	9207	9440	9663
N32MMMLF	6145	6813	7213	7436	7649	7854	8067	8272	8486	8690
N32MMMLSF	6516	7244	7680	7923	8155	8378	8611	8834	9067	9290
N32MMMRF	6145	6813	7213	7436	7649	7854	8067	8272	8486	8690
N32MMMRSF	6516	7244	7680	7923	8155	8378	8611	8834	9067	9290
N32MMWBF	6635	7303	7703	7926	8139	8344	8557	8762	8976	9180
N32MMWBSF	7005	7733	8169	8412	8644	8867	9100	9323	9556	9779
N32MMWLF	6262	6930	7330	7553	7766	7971	8184	8389	8603	8807
N32MMWLSF	6632	7360	7796	8039	8271	8494	8727	8950	9183	9406
N32MMWRF	6262	6930	7330	7553	7766	7971	8184	8389	8603	8807
N32MMWRSF	6632	7360	7796	8039	8271	8494	8727	8950	9183	9406
N32SAAMF	3311	3679	3899	4022	4139	4252	4369	4482	4600	4712
N32SAAMSF	3433	3808	4033	4158	4278	4393	4513	4628	4748	4863
N32SAAWF	3427	3795	4015	4138	4255	4368	4485	4598	4716	4828
N32SAAWSF	3550	3925	4150	4275	4395	4510	4630	4745	4865	4980
N32SBBMF	3458	3826	4046	4169	4286	4399	4516	4629	4747	4859
N32SBBMSF	3550	3925	4150	4275	4395	4510	4630	4745	4865	4980
N32SBBWF	3576	3944	4164	4287	4404	4517	4634	4747	4865	4977
N32SBBWSF	3698	4073	4298	4423	4543	4658	4778	4893	5013	5128
N32SCCMLF	3683	4051	4271	4394	4511	4624	4741	4854	4972	5084
N32SCCMLSF	3806	4181	4406	4531	4651	4766	4886	5001	5121	5236
N32SCCMRF	3683	4051	4271	4394	4511	4624	4741	4854	4972	5084
N32SCCMRSF	3806	4181	4406	4531	4651	4766	4886	5001	5121	5236
N32SCCWLF	3800	4168	4388	4511	4628	4741	4858	4971	5089	5201
N32SCCWLSF	3923	4298	4523	4648	4768	4883	5003	5118	5238	5353
N32SCCWRF	3800	4168	4388	4511	4628	4741	4858	4971	5089	5201
N32SCCWRSF	3923	4298	4523	4648	4768	4883	5003	5118	5238	5353
N32SDDMLF	3818	4186	4406	4529	4646	4759	4876	4989	5107	5219
N32SDDMLSF	3940	4315	4540	4665	4785	4900	5020	5135	5255	5370
N32SDDMRF	3818	4186	4406	4529	4646	4759	4876	4989	5107	5219
N32SDDMRSF	3940	4315	4540	4665	4785	4900	5020	5135	5255	5370
N32SDDWLF	3934	4302	4522	4645	4762	4875	4992	5105	5223	5335
N32SDDWLSF	4058	4433	4658	4783	4903	5018	5138	5253	5373	5488
N32SDDWRF	3934	4302	4522	4645	4762	4875	4992	5105	5223	5335
N32SDDWRSF	4058	4433	4658	4783	4903	5018	5138	5253	5373	5488
N32SHHMF	5285	5960	6365	6590	6806	7013	7229	7436	7652	7859
N32SHHMSF	5762	6520	6974	7227	7469	7701	7944	8176	8418	8651
N32SHHWF	5403	6078	6483	6708	6924	7131	7347	7554	7770	7977
N32SHHWSF	5878	6636	7090	7343	7585	7817	8060	8292	8534	8767
N32SJJMBF	6029	6704	7109	7334	7550	7757	7973	8180	8396	8603
N32SJJMBSF	6505	7263	7717	7970	8212	8444	8687	8919	9161	9394
N32SJJMLF	5657	6332	6737	6962	7178	7385	7601	7808	8024	8231
N32SJJMLSF	6132	6890	7344	7597	7839	8071	8314	8546	8788	9021
N32SJJMRF	5657	6332	6737	6962	7178	7385	7601	7808	8024	8231
N32SJJMRSF	6132	6890	7344	7597	7839	8071	8314	8546	8788	9021

Alliance Program TB133 Fire Rated Pricing

Finishes

IM	Brighton	CW	Cordovan
NM	Natural	DW	Judicial
HN	Honey	MH	Mocha
CL	Caramel	405	Designer White
TF	Truffle	462	Cinder
AC	Autumn	792	Sable
MC	Amber	793	Acorn

To order, specify the following:

1. Chair Model Number
2. Fabric Grade Letter
3. Alliance Pattern Number and Color Number/Name
4. Finish Number (when applicable)

Sample Order Number

<u>N14KKF</u>	<u>A</u>	<u>403901</u>	<u>036</u>	<u>HN</u>
Model Number	Fabric Grade Letter	Alliance Pattern Number	Alliance Color Number	Finish

Model Number

Alliance Program TB133 Price Grades

	A	B	C	D	E	F	G	H	I	J
N32SJJWBF	\$ 4058	\$ 4265	\$ 4445	\$ 4625	\$ 4814	\$ 5030	\$ 5183	\$ 5390	\$ 5615	\$ 5813
N32SJJWBSF	4280	4512	4714	4916	5128	5371	5542	5775	6027	6249
N32SJJWLF	3685	3892	4072	4252	4441	4657	4810	5017	5242	5440
N32SJJWLSF	3907	4139	4341	4543	4755	4998	5169	5402	5654	5876
N32SJJWRF	3685	3892	4072	4252	4441	4657	4810	5017	5242	5440
N32SJJWRSF	3907	4139	4341	4543	4755	4998	5169	5402	5654	5876
N32SLLMF	3708	3913	4091	4269	4456	4669	4821	5025	5248	5444
N32SLLMSF	3894	4117	4311	4505	4708	4941	5106	5329	5572	5785
N32SLLWF	3825	4030	4208	4386	4573	4786	4938	5142	5365	5561
N32SLLWSF	4011	4234	4428	4622	4825	5058	5223	5446	5689	5902
N32SMAAMF	1807	1872	1928	1984	2043	2110	2157	2222	2292	2353
N32SMAAWF	1924	1989	2045	2101	2160	2227	2274	2339	2409	2470
N32SMBBMF	1955	2020	2076	2132	2191	2258	2305	2370	2440	2501
N32SMBBWF	2072	2137	2193	2249	2308	2375	2422	2487	2557	2618
N32SMHHMF	2795	2947	3079	3211	3349	3508	3620	3772	3937	4082
N32SMHHWF	2912	3064	3196	3328	3466	3625	3737	3889	4054	4199
N32SMLLMF	3209	3340	3454	3568	3687	3824	3921	4052	4195	4320
N32SMLLWF	3326	3457	3571	3685	3804	3941	4038	4169	4312	4437
N32SMMMBF	4452	4657	4835	5013	5200	5413	5565	5769	5992	6188
N32SMMMBSF	4639	4862	5056	5250	5453	5686	5851	6074	6317	6530
N32SMMLLF	4080	4285	4463	4641	4828	5041	5193	5397	5620	5816
N32SMMLLSF	4266	4489	4683	4877	5080	5313	5478	5701	5944	6157
N32SMMRF	4080	4285	4463	4641	4828	5041	5193	5397	5620	5816
N32SMMRSF	4266	4489	4683	4877	5080	5313	5478	5701	5944	6157
N32SMMWBF	4570	4775	4953	5131	5318	5531	5683	5887	6110	6306
N32SMMWBSF	4755	4978	5172	5366	5569	5802	5967	6190	6433	6646
N32SMMWLF	4197	4402	4580	4758	4945	5158	5310	5514	5737	5933
N32SMMWLSF	4382	4605	4799	4993	5196	5429	5594	5817	6060	6273
N32SMMWRF	4197	4402	4580	4758	4945	5158	5310	5514	5737	5933
N32SMMWRSF	4382	4605	4799	4993	5196	5429	5594	5817	6060	6273
N32STAAWF	2564	2629	2685	2741	2800	2867	2914	2979	3049	3110
N32STHHWF	3552	3704	3836	3968	4106	4265	4377	4529	4694	4839
N32STLLWF	3965	4096	4210	4324	4443	4580	4677	4808	4951	5076
N32TAAWF	2564	2629	2685	2741	2800	2867	2914	2979	3049	3110
N32THHWF	3552	3704	3836	3968	4106	4265	4377	4529	4694	4839
N32TLLWF	3965	4096	4210	4324	4443	4580	4677	4808	4951	5076
N35AACF	895	918	938	958	979	1003	1020	1043	1068	1090
N35AACSF	992	1015	1035	1055	1076	1100	1117	1140	1165	1187
N35ABCF	1034	1073	1107	1141	1176	1217	1246	1285	1328	1365
N35ABCSF	1131	1170	1204	1238	1273	1314	1343	1382	1425	1462
N35ACCDF	1150	1173	1193	1213	1234	1258	1275	1298	1323	1345
N35ACDSSF	1248	1271	1291	1311	1332	1356	1373	1396	1421	1443
N35ACCF	1038	1061	1081	1101	1122	1146	1163	1186	1211	1233
N35ACCSF	1135	1158	1178	1198	1219	1243	1260	1283	1308	1330
N35AECDF	1291	1330	1364	1398	1433	1474	1503	1542	1585	1622
N35AECDSF	1388	1427	1461	1495	1530	1571	1600	1639	1682	1719
N35AECF	1178	1217	1251	1285	1320	1361	1390	1429	1472	1509

Model Number	Alliance Program TB133 Price Grades									
	K	L	M	N	O	P	Q	R	S	T
N32SJJWBF	\$ 6146	\$ 6821	\$ 7226	\$ 7451	\$ 7667	\$ 7874	\$ 8090	\$ 8297	\$ 8513	\$ 8720
N32SJJWBSF	6623	7381	7835	8088	8330	8562	8805	9037	9279	9512
N32SJJWLF	5773	6448	6853	7078	7294	7501	7717	7924	8140	8347
N32SJJWLSF	6250	7008	7462	7715	7957	8189	8432	8664	8906	9139
N32SJJWRF	5773	6448	6853	7078	7294	7501	7717	7924	8140	8347
N32SJJWRSF	6250	7008	7462	7715	7957	8189	8432	8664	8906	9139
N32SLLMF	5773	6441	6841	7064	7277	7482	7695	7900	8114	8318
N32SLLMSF	6144	6872	7308	7551	7783	8006	8239	8462	8695	8918
N32SLLWF	5890	6558	6958	7181	7394	7599	7812	8017	8231	8435
N32SLLWSF	6261	6989	7425	7668	7900	8123	8356	8579	8812	9035
N32SMAAMF	2457	2667	2793	2863	2930	2995	3062	3126	3193	3258
N32SMAAWF	2574	2784	2910	2980	3047	3112	3179	3243	3310	3375
N32SMBBMF	2605	2815	2941	3011	3078	3143	3210	3274	3341	3406
N32SMBBWF	2722	2932	3058	3128	3195	3260	3327	3391	3458	3523
N32SMHMF	4326	4821	5118	5283	5441	5593	5752	5903	6062	6214
N32SMHWF	4443	4938	5235	5400	5558	5710	5869	6020	6179	6331
N32SMLLMF	4531	4959	5215	5358	5494	5625	5762	5893	6030	6161
N32SMLLWF	4648	5076	5332	5475	5611	5742	5879	6010	6147	6278
N32SMMMBF	6517	7185	7585	7808	8021	8226	8439	8644	8858	9062
N32SMMMBSF	6889	7617	8053	8296	8528	8751	8984	9207	9440	9663
N32SMMLLF	6145	6813	7213	7436	7649	7854	8067	8272	8486	8690
N32SMMLSF	6516	7244	7680	7923	8155	8378	8611	8834	9067	9290
N32SMMRF	6145	6813	7213	7436	7649	7854	8067	8272	8486	8690
N32SMMRSF	6516	7244	7680	7923	8155	8378	8611	8834	9067	9290
N32SMMWBF	6635	7303	7703	7926	8139	8344	8557	8762	8976	9180
N32SMMWBSF	7005	7733	8169	8412	8644	8867	9100	9323	9556	9779
N32SMMWLF	6262	6930	7330	7553	7766	7971	8184	8389	8603	8807
N32SMMWLSF	6632	7360	7796	8039	8271	8494	8727	8950	9183	9406
N32SMMWRF	6262	6930	7330	7553	7766	7971	8184	8389	8603	8807
N32SMMWRSF	6632	7360	7796	8039	8271	8494	8727	8950	9183	9406
N32STAAWF	3214	3424	3550	3620	3687	3752	3819	3883	3950	4015
N32STHHWF	5083	5578	5875	6040	6198	6350	6509	6660	6819	6971
N32STLLWF	5287	5715	5971	6114	6250	6381	6518	6649	6786	6917
N32TAAWF	3214	3424	3550	3620	3687	3752	3819	3883	3950	4015
N32THHWF	5083	5578	5875	6040	6198	6350	6509	6660	6819	6971
N32TLLWF	5287	5715	5971	6114	6250	6381	6518	6649	6786	6917
N35AACF	1127	1202	1247	1272	1296	1319	1343	1366	1390	1413
N35AACSF	1224	1299	1344	1369	1393	1416	1440	1463	1487	1510
N35ABCF	1428	1556	1632	1675	1715	1754	1795	1834	1875	1914
N35ABCSF	1525	1653	1729	1772	1812	1851	1892	1931	1972	2011
N35ACCDF	1382	1457	1502	1527	1551	1574	1598	1621	1645	1668
N35ACDSF	1480	1555	1600	1625	1649	1672	1696	1719	1743	1766
N35ACCF	1270	1345	1390	1415	1439	1462	1486	1509	1533	1556
N35ACCSF	1367	1442	1487	1512	1536	1559	1583	1606	1630	1653
N35AECDF	1685	1813	1889	1932	1972	2011	2052	2091	2132	2171
N35AECDSF	1782	1910	1986	2029	2069	2108	2149	2188	2229	2268
N35AECF	1572	1700	1776	1819	1859	1898	1939	1978	2019	2058

Alliance Program TB133 Fire Rated Pricing

Finishes

IM	Brighton	CW	Cordovan
NM	Natural	DW	Judicial
HN	Honey	MH	Mocha
CL	Caramel	405	Designer White
TF	Truffle	462	Cinder
AC	Autumn	792	Sable
MC	Amber	793	Acorn

To order, specify the following:

1. Chair Model Number
2. Fabric Grade Letter
3. Alliance Pattern Number and Color Number/Name
4. Finish Number (when applicable)

Sample Order Number

<u>N14KKF</u>	<u>A</u>	<u>403901</u>	<u>036</u>	<u>HN</u>
Model Number	Fabric Grade Letter	Alliance Pattern Number	Alliance Color Number	Finish

Model Number

Alliance Program TB133 Price Grades

	A	B	C	D	E	F	G	H	I	J
N35AECFSF	\$ 1274	\$ 1313	\$ 1347	\$ 1381	\$ 1416	\$ 1457	\$ 1486	\$ 1525	\$ 1568	\$ 1605
N35AJCFSF	1120	1143	1163	1183	1204	1228	1245	1268	1293	1315
N35AJCSF	1216	1239	1259	1279	1300	1324	1341	1364	1389	1411
N35AMCF	1259	1298	1332	1366	1401	1442	1471	1510	1553	1590
N35AMCSF	1357	1396	1430	1464	1499	1540	1569	1608	1651	1688
N35AOCDF	1261	1286	1308	1330	1353	1380	1398	1424	1451	1475
N35AOCDSF	1349	1374	1396	1418	1441	1468	1486	1512	1539	1563
N35AOCSF	1148	1173	1195	1217	1240	1267	1285	1311	1338	1362
N35AOCDF	1237	1262	1284	1306	1329	1356	1374	1400	1427	1451
N35APCDF	1384	1423	1457	1491	1526	1567	1596	1635	1678	1715
N35APCDSF	1474	1513	1547	1581	1616	1657	1686	1725	1768	1805
N35APCF	1271	1310	1344	1378	1413	1454	1483	1522	1565	1602
N35APCSF	1362	1401	1435	1469	1504	1545	1574	1613	1656	1693
N35ASCF	1170	1195	1217	1239	1262	1289	1307	1333	1360	1384
N35ASCSF	1261	1286	1308	1330	1353	1380	1398	1424	1451	1475
N35ATCF	1294	1333	1367	1401	1436	1477	1506	1545	1588	1625
N35ATCSF	1390	1429	1463	1497	1532	1573	1602	1641	1684	1721
N35BACF	802	825	845	865	886	910	927	950	975	997
N35BACFSF	899	922	942	962	983	1007	1024	1047	1072	1094
N35BBCF	944	983	1017	1051	1086	1127	1156	1195	1238	1275
N35BBCFSF	1039	1078	1112	1146	1181	1222	1251	1290	1333	1370
N35BCCDF	1058	1081	1101	1121	1142	1166	1183	1206	1231	1253
N35BCCDSF	1154	1177	1197	1217	1238	1262	1279	1302	1327	1349
N35BCCF	946	969	989	1009	1030	1054	1071	1094	1119	1141
N35BCCFSF	1042	1065	1085	1105	1126	1150	1167	1190	1215	1237
N35BECDF	1199	1238	1272	1306	1341	1382	1411	1450	1493	1530
N35BECDSF	1295	1334	1368	1402	1437	1478	1507	1546	1589	1626
N35BECF	1086	1125	1159	1193	1228	1269	1298	1337	1380	1417
N35BECFSF	1183	1222	1256	1290	1325	1366	1395	1434	1477	1514
N35BJCF	1027	1050	1070	1090	1111	1135	1152	1175	1200	1222
N35BJCSF	1124	1147	1167	1187	1208	1232	1249	1272	1297	1319
N35BMCF	1168	1207	1241	1275	1310	1351	1380	1419	1462	1499
N35BMCSF	1264	1303	1337	1371	1406	1447	1476	1515	1558	1595
N35BOCDF	1164	1189	1211	1233	1256	1283	1301	1327	1354	1378
N35BOCDSF	1261	1286	1308	1330	1353	1380	1398	1424	1451	1475
N35BOCF	1052	1077	1099	1121	1144	1171	1189	1215	1242	1266
N35BOCSF	1148	1173	1195	1217	1240	1267	1285	1311	1338	1362
N35BPCDF	1288	1327	1361	1395	1430	1471	1500	1539	1582	1619
N35BPCDSF	1384	1423	1457	1491	1526	1567	1596	1635	1678	1715
N35BPCF	1175	1214	1248	1282	1317	1358	1387	1426	1469	1506
N35BPCFSF	1271	1310	1344	1378	1413	1454	1483	1522	1565	1602
N35BSCF	1069	1094	1116	1138	1161	1188	1206	1232	1259	1283
N35BSCFSF	1170	1195	1217	1239	1262	1289	1307	1333	1360	1384
N35BTCF	1198	1237	1271	1305	1340	1381	1410	1449	1492	1529
N35BTCFSF	1293	1332	1366	1400	1435	1476	1505	1544	1587	1624
N35CACF	870	891	909	927	946	967	983	1003	1026	1046
N35CBCF	994	1029	1059	1089	1120	1156	1182	1216	1254	1287

Model Number	Alliance Program TB133 Price Grades									
	K	L	M	N	O	P	Q	R	S	T
N35AECSF	\$ 1668	\$ 1796	\$ 1872	\$ 1915	\$ 1955	\$ 1994	\$ 2035	\$ 2074	\$ 2115	\$ 2154
N35AJCF	1352	1427	1472	1497	1521	1544	1568	1591	1615	1638
N35AJCSF	1448	1523	1568	1593	1617	1640	1664	1687	1711	1734
N35AMCF	1653	1781	1857	1900	1940	1979	2020	2059	2100	2139
N35AMCSF	1751	1879	1955	1998	2038	2077	2118	2157	2198	2237
N35AOCDF	1516	1599	1648	1676	1702	1727	1754	1779	1805	1831
N35AOCDSF	1604	1687	1736	1764	1790	1815	1842	1867	1893	1919
N35AOCF	1403	1486	1535	1563	1589	1614	1641	1666	1692	1718
N35AOCFSF	1492	1575	1624	1652	1678	1703	1730	1755	1781	1807
N35APCDF	1778	1906	1982	2025	2065	2104	2145	2184	2225	2264
N35APCDSF	1868	1996	2072	2115	2155	2194	2235	2274	2315	2354
N35APCF	1665	1793	1869	1912	1952	1991	2032	2071	2112	2151
N35APCSF	1756	1884	1960	2003	2043	2082	2123	2162	2203	2242
N35ASCF	1425	1508	1557	1585	1611	1636	1663	1688	1714	1740
N35ASCSF	1516	1599	1648	1676	1702	1727	1754	1779	1805	1831
N35ATCF	1688	1816	1892	1935	1975	2014	2055	2094	2135	2174
N35ATCSF	1784	1912	1988	2031	2071	2110	2151	2190	2231	2270
N35BACF	1034	1109	1154	1179	1203	1226	1250	1273	1297	1320
N35BACSF	1131	1206	1251	1276	1300	1323	1347	1370	1394	1417
N35BBCF	1338	1466	1542	1585	1625	1664	1705	1744	1785	1824
N35BBCSF	1433	1561	1637	1680	1720	1759	1800	1839	1880	1919
N35BCCDF	1290	1365	1410	1435	1459	1482	1506	1529	1553	1576
N35BCCDSF	1386	1461	1506	1531	1555	1578	1602	1625	1649	1672
N35BCCF	1178	1253	1298	1323	1347	1370	1394	1417	1441	1464
N35BCCSF	1274	1349	1394	1419	1443	1466	1490	1513	1537	1560
N35BECDF	1593	1721	1797	1840	1880	1919	1960	1999	2040	2079
N35BECDSF	1689	1817	1893	1936	1976	2015	2056	2095	2136	2175
N35BECF	1480	1608	1684	1727	1767	1806	1847	1886	1927	1966
N35BECSF	1577	1705	1781	1824	1864	1903	1944	1983	2024	2063
N35BJCF	1259	1334	1379	1404	1428	1451	1475	1498	1522	1545
N35BJCSF	1356	1431	1476	1501	1525	1548	1572	1595	1619	1642
N35BMCF	1562	1690	1766	1809	1849	1888	1929	1968	2009	2048
N35BMCSF	1658	1786	1862	1905	1945	1984	2025	2064	2105	2144
N35BOCDF	1419	1502	1551	1579	1605	1630	1657	1682	1708	1734
N35BOCDSF	1516	1599	1648	1676	1702	1727	1754	1779	1805	1831
N35BOCF	1307	1390	1439	1467	1493	1518	1545	1570	1596	1622
N35BOCSF	1403	1486	1535	1563	1589	1614	1641	1666	1692	1718
N35BPCDF	1682	1810	1886	1929	1969	2008	2049	2088	2129	2168
N35BPCDSF	1778	1906	1982	2025	2065	2104	2145	2184	2225	2264
N35BPCF	1569	1697	1773	1816	1856	1895	1936	1975	2016	2055
N35BPCSF	1665	1793	1869	1912	1952	1991	2032	2071	2112	2151
N35BSCF	1324	1407	1456	1484	1510	1535	1562	1587	1613	1639
N35BSCSF	1425	1508	1557	1585	1611	1636	1663	1688	1714	1740
N35BTCF	1592	1720	1796	1839	1879	1918	1959	1998	2039	2078
N35BTCFSF	1687	1815	1891	1934	1974	2013	2054	2093	2134	2173
N35CACF	1079	1147	1187	1210	1231	1252	1273	1294	1316	1336
N35CBCF	1342	1455	1522	1560	1596	1630	1666	1701	1737	1771

Alliance Program TB133 Fire Rated Pricing

Finishes

IM	Brighton	CW	Cordovan
NM	Natural	DW	Judicial
HN	Honey	MH	Mocha
CL	Caramel	405	Designer White
TF	Truffle	462	Cinder
AC	Autumn	792	Sable
MC	Amber	793	Acorn

To order, specify the following:

1. Chair Model Number
2. Fabric Grade Letter
3. Alliance Pattern Number and Color Number/Name
4. Finish Number (when applicable)

Sample Order Number

<u>N14KKF</u>	<u>A</u>	<u>403901</u>	<u>036</u>	<u>HN</u>
Model Number	Fabric Grade Letter	Alliance Pattern Number	Alliance Color Number	Finish

Model Number

Alliance Program TB133 Price Grades

	A	B	C	D	E	F	G	H	I	J
N35CCCDF	\$ 1126	\$ 1147	\$ 1165	\$ 1183	\$ 1202	\$ 1223	\$ 1239	\$ 1259	\$ 1282	\$ 1302
N35CCCF	1013	1034	1052	1070	1089	1110	1126	1146	1169	1189
N35CECDF	1252	1287	1317	1347	1378	1414	1440	1474	1512	1545
N35CECF	1139	1174	1204	1234	1265	1301	1327	1361	1399	1432
N35CJCF	1094	1115	1133	1151	1170	1191	1207	1227	1250	1270
N35CMCF	1220	1255	1285	1315	1346	1382	1408	1442	1480	1513
N35COCDF	1225	1246	1264	1282	1301	1322	1338	1358	1381	1401
N35COCF	1111	1132	1150	1168	1187	1208	1224	1244	1267	1287
N35PCPDF	1348	1383	1413	1443	1474	1510	1536	1570	1608	1641
N35PCPF	1235	1270	1300	1330	1361	1397	1423	1457	1495	1528
N35CSCF	1135	1156	1174	1192	1211	1232	1248	1268	1291	1311
N35CTCF	1260	1295	1325	1355	1386	1422	1448	1482	1520	1553
N35EACF	974	995	1013	1031	1050	1071	1087	1107	1130	1150
N35EBCF	1099	1134	1164	1194	1225	1261	1287	1321	1359	1392
N35ECCDF	1237	1258	1276	1294	1313	1334	1350	1370	1393	1413
N35ECCF	1125	1146	1164	1182	1201	1222	1238	1258	1281	1301
N35EECDF	1363	1398	1428	1458	1489	1525	1551	1585	1623	1656
N35EECF	1251	1286	1316	1346	1377	1413	1439	1473	1511	1544
N35JACF	1325	1350	1372	1394	1417	1444	1462	1488	1515	1539
N35JCCF	1506	1531	1553	1575	1598	1625	1643	1669	1696	1720
N35MACF	1984	2044	2096	2148	2202	2265	2309	2369	2434	2491
N35MBCF	2166	2226	2278	2330	2384	2447	2491	2551	2616	2673
39A-BWAAF	1610	1654	1692	1730	1770	1815	1848	1891	1939	1981
39A-BWAATF	1695	1739	1777	1815	1855	1900	1933	1976	2024	2066
39A-GRXXF	772	797	819	841	864	891	909	935	962	986
39A-GWXXF	857	882	904	926	949	976	994	1020	1047	1071
39A-GWXTF	943	968	990	1012	1035	1062	1080	1106	1133	1157
39A-TAAAF	2328	2390	2444	2498	2554	2619	2665	2727	2795	2854
39A-TAAATF	2500	2562	2616	2670	2726	2791	2837	2899	2967	3026
39A-TAAF	1539	1581	1617	1653	1691	1734	1764	1806	1851	1890
39A-TAATF	1671	1713	1749	1785	1823	1866	1896	1938	1983	2022
39B-GRXXF	721	738	753	768	784	802	814	832	850	867
39B-GWXXF	802	819	834	849	865	883	895	913	931	948
39B-GWXTF	894	913	929	945	962	981	994	1013	1033	1050
39D-GRXXF	729	746	761	776	792	810	822	840	858	875
39D-GWXXF	814	831	846	861	877	895	907	925	943	960
39D-GWXTF	905	924	940	956	973	992	1005	1024	1044	1061
39E-GRXXF	778	805	828	851	876	903	923	950	979	1004
39E-GWXXF	863	890	913	936	961	988	1008	1035	1064	1089
39E-GWXTF	966	996	1022	1048	1076	1107	1129	1159	1191	1220
39H-GRXXF	778	805	828	851	876	903	923	950	979	1004
39H-GWXXF	863	890	913	936	961	988	1008	1035	1064	1089
39H-GWXTF	905	924	940	956	973	992	1005	1024	1044	1061
39L-GRXXF	721	738	753	768	784	802	814	832	850	867
39L-GWXXF	802	819	834	849	865	883	895	913	931	948
39L-GWXTF	894	913	929	945	962	981	994	1013	1033	1050
39S-GRXXF	767	784	799	814	830	848	860	878	896	913

Model Number	Alliance Program TB133 Price Grades									
	K	L	M	N	O	P	Q	R	S	T
N35CCCDF	\$ 1335	\$ 1403	\$ 1443	\$ 1466	\$ 1487	\$ 1508	\$ 1529	\$ 1550	\$ 1572	\$ 1592
N35CCCF	1222	1290	1330	1353	1374	1395	1416	1437	1459	1479
N35CECDF	1600	1713	1780	1818	1854	1888	1924	1959	1995	2029
N35CECF	1487	1600	1667	1705	1741	1775	1811	1846	1882	1916
N35CJCF	1303	1371	1411	1434	1455	1476	1497	1518	1540	1560
N35CMCF	1568	1681	1748	1786	1822	1856	1892	1927	1963	1997
N35COCDF	1434	1502	1542	1565	1586	1607	1628	1649	1671	1691
N35COCF	1320	1388	1428	1451	1472	1493	1514	1535	1557	1577
N35PCPDF	1696	1809	1876	1914	1950	1984	2020	2055	2091	2125
N35PCPF	1583	1696	1763	1801	1837	1871	1907	1942	1978	2012
N35SCSF	1344	1412	1452	1475	1496	1517	1538	1559	1581	1601
N35CTCF	1608	1721	1788	1826	1862	1896	1932	1967	2003	2037
N35EACF	1183	1251	1291	1314	1335	1356	1377	1398	1420	1440
N35EBCF	1447	1560	1627	1665	1701	1735	1771	1806	1842	1876
N35ECCDF	1446	1514	1554	1577	1598	1619	1640	1661	1683	1703
N35ECCF	1334	1402	1442	1465	1486	1507	1528	1549	1571	1591
N35EEDDF	1711	1824	1891	1929	1965	1999	2035	2070	2106	2140
N35EECF	1599	1712	1779	1817	1853	1887	1923	1958	1994	2028
N35JACF	1580	1663	1712	1740	1766	1791	1818	1843	1869	1895
N35JCCF	1761	1844	1893	1921	1947	1972	1999	2024	2050	2076
N35MACF	2587	2782	2899	2964	3026	3086	3149	3208	3271	3331
N35MBCF	2769	2964	3081	3146	3208	3268	3331	3390	3453	3513
39A-BWAAF	2051	2194	2279	2327	2372	2416	2461	2505	2551	2594
39A-BWAATF	2136	2279	2364	2412	2457	2501	2546	2590	2636	2679
39A-GRXXF	1027	1110	1159	1187	1213	1238	1265	1290	1316	1342
39A-GWXXF	1112	1195	1244	1272	1298	1323	1350	1375	1401	1427
39A-GWXTF	1198	1281	1330	1358	1384	1409	1436	1461	1487	1513
39A-TAAAF	2954	3157	3278	3346	3410	3472	3537	3599	3664	3726
39A-TAAATF	3126	3329	3450	3518	3582	3644	3709	3771	3836	3898
39A-TAAF	1957	2092	2173	2218	2261	2303	2346	2387	2430	2472
39A-TAATF	2089	2224	2305	2350	2393	2435	2478	2519	2562	2604
39B-GRXXF	895	951	985	1003	1021	1039	1057	1074	1092	1109
39B-GWXXF	976	1032	1066	1084	1102	1120	1138	1155	1173	1190
39B-GWXTF	1080	1140	1176	1196	1215	1234	1253	1271	1290	1309
39D-GRXXF	903	959	993	1011	1029	1047	1065	1082	1100	1117
39D-GWXXF	988	1044	1078	1096	1114	1132	1150	1167	1185	1202
39D-GWXTF	1091	1151	1187	1207	1226	1245	1264	1282	1301	1320
39E-GRXXF	1047	1134	1186	1215	1243	1270	1298	1324	1352	1379
39E-GWXXF	1132	1219	1271	1300	1328	1355	1383	1409	1437	1464
39E-GWXTF	1268	1366	1424	1457	1488	1518	1549	1579	1610	1640
39H-GRXXF	1047	1134	1186	1215	1243	1270	1298	1324	1352	1379
39H-GWXXF	1132	1219	1271	1300	1328	1355	1383	1409	1437	1464
39H-GWXTF	1091	1151	1187	1207	1226	1245	1264	1282	1301	1320
39L-GRXXF	895	951	985	1003	1021	1039	1057	1074	1092	1109
39L-GWXXF	976	1032	1066	1084	1102	1120	1138	1155	1173	1190
39L-GWXTF	1080	1140	1176	1196	1215	1234	1253	1271	1290	1309
39S-GRXXF	941	997	1031	1049	1067	1085	1103	1120	1138	1155

Alliance Program TB133 Fire Rated Pricing

Finishes

IM	Brighton	CW	Cordovan
NM	Natural	DW	Judicial
HN	Honey	MH	Mocha
CL	Caramel	405	Designer White
TF	Truffle	462	Cinder
AC	Autumn	792	Sable
MC	Amber	793	Acorn

To order, specify the following:

1. Chair Model Number
2. Fabric Grade Letter
3. Alliance Pattern Number and Color Number/Name
4. Finish Number (when applicable)

Sample Order Number

<u>N14KKF</u>	<u>A</u>	<u>403901</u>	<u>036</u>	<u>HN</u>
Model Number	Fabric Grade Letter	Alliance Pattern Number	Alliance Color Number	Finish

Model Number

Alliance Program TB133 Price Grades

	A	B	C	D	E	F	G	H	I	J
39S-GWXXF	\$ 851	\$ 868	\$ 883	\$ 898	\$ 914	\$ 932	\$ 944	\$ 962	\$ 980	\$ 997
39S-GWXTF	941	960	976	992	1009	1028	1041	1060	1080	1097
39U-GRXXF	788	815	838	861	886	913	933	960	989	1014
39U-GWXXF	870	897	920	943	968	995	1015	1042	1071	1096
39U-GWXTF	974	1004	1030	1056	1084	1115	1137	1167	1199	1228
N45AUF	1385	1414	1440	1464	1490	1522	1542	1572	1604	1631
N45AURF	443	451	457	464	471	478	484	491	500	507
N45BUF	1641	1670	1696	1720	1746	1778	1798	1828	1860	1887
N45BURF	528	536	542	549	556	563	569	576	585	592
N45CUF	600	608	614	621	628	635	641	648	657	664
N45HUF	733	741	747	754	761	768	774	781	790	797
N45HULF	624	632	638	645	652	659	665	672	681	688
N45JUF	853	861	867	874	881	888	894	901	910	917
N45JULF	744	752	758	765	772	779	785	792	801	808
N45U1F	422	430	436	443	450	457	463	470	479	486
N45U2F	844	858	871	884	897	912	923	938	953	967
N45U3F	1266	1288	1307	1326	1345	1368	1384	1406	1430	1450
48-EKF	1905	1972	2030	2088	2149	2218	2268	2334	2407	2471
48-EKJF	2130	2197	2255	2313	2374	2443	2493	2559	2632	2696
48-EKNF	1905	1972	2030	2088	2149	2218	2268	2334	2407	2471
48-EKNJF	2130	2197	2255	2313	2374	2443	2493	2559	2632	2696
48-ESF	1757	1833	1899	1965	2035	2114	2170	2246	2328	2401
48-ESJF	1982	2058	2124	2190	2260	2339	2395	2471	2553	2626
48-ESNF	1757	1833	1899	1965	2035	2114	2170	2246	2328	2401
48-ESNJF	1982	2058	2124	2190	2260	2339	2395	2471	2553	2626
48-GCF	1386	1453	1511	1569	1630	1699	1749	1815	1888	1952
48-GCNF	1386	1453	1511	1569	1630	1699	1749	1815	1888	1952
N48GFAF	1479	1518	1552	1586	1621	1662	1691	1730	1773	1810
N48GFMF	1412	1451	1485	1519	1554	1595	1624	1663	1706	1743
N52GHACF	756	775	791	807	824	843	856	875	895	912
N52GHAF	727	746	762	778	795	814	827	846	866	883
N52GHMCF	727	746	762	778	795	814	827	846	866	883
N52GHMF	700	719	735	751	768	787	800	819	839	856
N55AAF	966	1001	1031	1061	1092	1128	1154	1188	1226	1259
N55BBF	884	919	949	979	1010	1046	1072	1106	1144	1177
N55CCF	882	897	910	924	938	953	965	980	996	1011
N55DDF	800	815	828	842	856	871	883	898	914	929
N55EEF	857	880	900	920	941	965	982	1005	1030	1052
N55HHF	774	797	817	837	858	882	899	922	947	969
N59AAF	1017	1038	1056	1074	1093	1114	1130	1150	1173	1193
N59AATF	1104	1125	1143	1161	1180	1201	1217	1237	1260	1280
N59ALF	982	1003	1021	1039	1058	1079	1095	1115	1138	1158
N59BBF	1105	1132	1156	1180	1205	1234	1255	1282	1312	1339
N59BBTF	1190	1217	1241	1265	1290	1319	1340	1367	1397	1424
N59BLF	1071	1098	1122	1146	1171	1200	1221	1248	1278	1305
N59CCF	1086	1107	1125	1143	1162	1183	1199	1219	1242	1262
N59CCTF	1173	1194	1212	1230	1249	1270	1286	1306	1329	1349

Model Number	Alliance Program TB133 Price Grades									
	K	L	M	N	O	P	Q	R	S	T
39S-GWXXF	\$ 1025	\$ 1081	\$ 1115	\$ 1133	\$ 1151	\$ 1169	\$ 1187	\$ 1204	\$ 1222	\$ 1239
39S-GWXTF	1127	1187	1223	1243	1262	1281	1300	1318	1337	1356
39U-GRXXF	1057	1144	1196	1225	1253	1280	1308	1334	1362	1389
39U-GWXXF	1139	1226	1278	1307	1335	1362	1390	1416	1444	1471
39U-GWXTF	1276	1374	1432	1465	1496	1526	1557	1587	1618	1648
N45AUF	1678	1773	1830	1861	1891	1921	1951	1979	2009	2039
N45AURF	519	543	558	566	574	581	589	596	604	612
N45BURF	1934	2029	2086	2117	2147	2177	2207	2235	2265	2295
N45BURF	604	628	643	651	659	666	674	681	689	697
N45CUF	676	700	715	723	731	738	746	753	761	769
N45HUF	809	833	848	856	864	871	879	886	894	902
N45HULF	700	724	739	747	755	762	770	777	785	793
N45JUF	929	953	968	976	984	991	999	1006	1014	1022
N45JULF	820	844	859	867	875	882	890	897	905	913
N45U1F	498	522	537	545	553	560	568	575	583	591
N45U2F	990	1038	1066	1082	1097	1112	1127	1141	1156	1171
N45U3F	1485	1557	1600	1623	1645	1668	1690	1712	1734	1757
48-EKF	2578	2796	2926	2999	3068	3135	3204	3271	3341	3407
48-EKJF	2803	3021	3151	3224	3293	3360	3429	3496	3566	3632
48-EKNF	2578	2796	2926	2999	3068	3135	3204	3271	3341	3407
48-EKNJF	2803	3021	3151	3224	3293	3360	3429	3496	3566	3632
48-ESF	2523	2771	2919	3002	3081	3157	3236	3312	3391	3467
48-ESJF	2748	2996	3144	3227	3306	3382	3461	3537	3616	3692
48-ESNF	2523	2771	2919	3002	3081	3157	3236	3312	3391	3467
48-ESNJF	2748	2996	3144	3227	3306	3382	3461	3537	3616	3692
48-GCF	2059	2277	2407	2480	2549	2616	2685	2752	2822	2888
48-GCNF	2059	2277	2407	2480	2549	2616	2685	2752	2822	2888
N48GFAF	1873	2001	2077	2120	2160	2199	2240	2279	2320	2359
N48GFMF	1806	1934	2010	2053	2093	2132	2173	2212	2253	2292
N52GHACF	942	1002	1038	1058	1077	1096	1115	1133	1152	1171
N52GHAF	913	973	1009	1029	1048	1067	1086	1104	1123	1142
N52GHMCF	913	973	1009	1029	1048	1067	1086	1104	1123	1142
N52GHMF	886	946	982	1002	1021	1040	1059	1077	1096	1115
N55AAF	1314	1427	1494	1532	1568	1602	1638	1673	1709	1743
N55BBF	1232	1345	1412	1450	1486	1520	1556	1591	1627	1661
N55CCF	1035	1085	1114	1131	1147	1162	1178	1193	1209	1224
N55DDF	953	1003	1032	1049	1065	1080	1096	1111	1127	1142
N55EEF	1089	1164	1209	1234	1258	1281	1305	1328	1352	1375
N55HHF	1006	1081	1126	1151	1175	1198	1222	1245	1269	1292
N59AAF	1226	1294	1334	1357	1378	1399	1420	1441	1463	1483
N59AATF	1313	1381	1421	1444	1465	1486	1507	1528	1550	1570
N59ALF	1191	1259	1299	1322	1343	1364	1385	1406	1428	1448
N59BBF	1383	1473	1527	1557	1586	1613	1642	1670	1699	1726
N59BBTF	1468	1558	1612	1642	1671	1698	1727	1755	1784	1811
N59BLF	1349	1439	1493	1523	1552	1579	1608	1636	1665	1692
N59CCF	1295	1363	1403	1426	1447	1468	1489	1510	1532	1552
N59CCTF	1382	1450	1490	1513	1534	1555	1576	1597	1619	1639

Alliance Program TB133 Fire Rated Pricing

Finishes

IM	Brighton	CW	Cordovan
NM	Natural	DW	Judicial
HN	Honey	MH	Mocha
CL	Caramel	405	Designer White
TF	Truffle	462	Cinder
AC	Autumn	792	Sable
MC	Amber	793	Acorn

To order, specify the following:

1. Chair Model Number
2. Fabric Grade Letter
3. Alliance Pattern Number and Color Number/Name
4. Finish Number (when applicable)

Sample Order Number

<u>N14KKF</u>	<u>A</u>	<u>403901</u>	<u>036</u>	<u>HN</u>
Model Number	Fabric Grade Letter	Alliance Pattern Number	Alliance Color Number	Finish

Model Number

Alliance Program TB133 Price Grades

	A	B	C	D	E	F	G	H	I	J
N59CLF	\$ 1051	\$ 1072	\$ 1090	\$ 1108	\$ 1127	\$ 1148	\$ 1164	\$ 1184	\$ 1207	\$ 1227
N59DDF	1109	1130	1148	1166	1185	1206	1222	1242	1265	1285
N59DDTF	1194	1215	1233	1251	1270	1291	1307	1327	1350	1370
N59DLF	1075	1096	1114	1132	1151	1172	1188	1208	1231	1251
N59HHF	1143	1164	1182	1200	1219	1240	1256	1276	1299	1319
N59HHTF	1228	1249	1267	1285	1304	1325	1341	1361	1384	1404
N59HLF	1109	1130	1148	1166	1185	1206	1222	1242	1265	1285
N59JJF	1184	1209	1231	1253	1276	1303	1321	1347	1374	1398
N59JJTF	1271	1296	1318	1340	1363	1390	1408	1434	1461	1485
N59JLF	1149	1174	1196	1218	1241	1268	1286	1312	1339	1363
N59KKF	1756	1777	1795	1813	1832	1853	1869	1889	1912	1932
N59KKTf	1843	1864	1882	1900	1919	1940	1956	1976	1999	2019
N59MMF	1779	1814	1844	1874	1905	1941	1967	2001	2039	2072
N59MMTF	1866	1901	1931	1961	1992	2028	2054	2088	2126	2159
N59PPF	1854	1886	1914	1942	1972	2005	2029	2061	2096	2127
N59PPTF	1940	1972	2000	2028	2058	2091	2115	2147	2182	2213
N60AAF	449	470	488	506	525	546	562	582	605	625
N60AWF	704	725	743	761	780	801	817	837	860	880
N60BBF	422	443	461	479	498	519	535	555	578	598
N60BWF	678	699	717	735	754	775	791	811	834	854
N60CCF	520	543	563	583	604	628	645	668	693	715
N60CWF	704	725	743	761	780	801	817	837	860	880
N60DDF	492	515	535	555	576	600	617	640	665	687
N60DWF	678	699	717	735	754	775	791	811	834	854
N60EEF	1152	1189	1221	1253	1286	1325	1352	1389	1429	1464
N60EMF	939	966	990	1014	1039	1068	1089	1116	1146	1173
N60EMWF	1137	1156	1172	1188	1205	1224	1237	1256	1276	1293
N60EWF	1389	1426	1458	1490	1523	1562	1589	1626	1666	1701
N60GGF	1209	1246	1278	1310	1343	1382	1409	1446	1486	1521
N60GMF	997	1024	1048	1072	1097	1126	1147	1174	1204	1231
N60GMWF	1137	1156	1172	1188	1205	1224	1237	1256	1276	1293
N60GWF	1389	1426	1458	1490	1523	1562	1589	1626	1666	1701
N60PMF	939	966	990	1014	1039	1068	1089	1116	1146	1173
N60PMWF	1137	1156	1172	1188	1205	1224	1237	1256	1276	1293
N60PPF	1152	1189	1221	1253	1286	1325	1352	1389	1429	1464
N60PWF	1389	1426	1458	1490	1523	1562	1589	1626	1666	1701
N60RMF	997	1024	1048	1072	1097	1126	1147	1174	1204	1231
N60RMWF	1137	1156	1172	1188	1205	1224	1237	1256	1276	1293
N60RRF	1209	1246	1278	1310	1343	1382	1409	1446	1486	1521
N60RWF	1389	1426	1458	1490	1523	1562	1589	1626	1666	1701
N60SAACF	508	529	547	565	584	605	621	641	664	684
N60SAAF	536	557	575	593	612	633	649	669	692	712
N60SAWCF	762	783	801	819	838	859	875	895	918	938
N60SAWF	792	813	831	849	868	889	905	925	948	968
N60SBBCF	480	501	519	537	556	577	593	613	636	656
N60SBBF	509	530	548	566	585	606	622	642	665	685
N60SBWCF	736	757	775	793	812	833	849	869	892	912

Model Number	Alliance Program TB133 Price Grades									
	K	L	M	N	O	P	Q	R	S	T
N59CLF	\$ 1260	\$ 1328	\$ 1368	\$ 1391	\$ 1412	\$ 1433	\$ 1454	\$ 1475	\$ 1497	\$ 1517
N59DDF	1318	1386	1426	1449	1470	1491	1512	1533	1555	1575
N59DDTF	1403	1471	1511	1534	1555	1576	1597	1618	1640	1660
N59DLF	1284	1352	1392	1415	1436	1457	1478	1499	1521	1541
N59HHF	1352	1420	1460	1483	1504	1525	1546	1567	1589	1609
N59HHTF	1437	1505	1545	1568	1589	1610	1631	1652	1674	1694
N59HLF	1318	1386	1426	1449	1470	1491	1512	1533	1555	1575
N59JJF	1439	1522	1571	1599	1625	1650	1677	1702	1728	1754
N59JJTF	1526	1609	1658	1686	1712	1737	1764	1789	1815	1841
N59JLF	1404	1487	1536	1564	1590	1615	1642	1667	1693	1719
N59KKF	1965	2033	2073	2096	2117	2138	2159	2180	2202	2222
N59KKTF	2052	2120	2160	2183	2204	2225	2246	2267	2289	2309
N59MMF	2127	2240	2307	2345	2381	2415	2451	2486	2522	2556
N59MMTF	2214	2327	2394	2432	2468	2502	2538	2573	2609	2643
N59PPF	2179	2284	2347	2382	2416	2448	2481	2514	2547	2579
N59PTF	2265	2370	2433	2468	2502	2534	2567	2600	2633	2665
N60AAF	658	726	766	789	810	831	852	873	895	915
N60AWF	913	981	1021	1044	1065	1086	1107	1128	1150	1170
N60BBF	631	699	739	762	783	804	825	846	868	888
N60BWF	887	955	995	1018	1039	1060	1081	1102	1124	1144
N60CCF	752	827	872	897	921	944	968	991	1015	1038
N60CWF	913	981	1021	1044	1065	1086	1107	1128	1150	1170
N60DDF	724	799	844	869	893	916	940	963	987	1010
N60DWF	887	955	995	1018	1039	1060	1081	1102	1124	1144
N60EEF	1523	1643	1715	1755	1793	1830	1869	1905	1944	1981
N60EMF	1217	1307	1361	1391	1420	1447	1476	1504	1533	1560
N60EMWF	1323	1383	1419	1439	1458	1477	1496	1514	1533	1552
N60EWF	1760	1880	1952	1992	2030	2067	2106	2142	2181	2218
N60GGF	1580	1700	1772	1812	1850	1887	1926	1962	2001	2038
N60GMF	1275	1365	1419	1449	1478	1505	1534	1562	1591	1618
N60GMWF	1323	1383	1419	1439	1458	1477	1496	1514	1533	1552
N60GWF	1760	1880	1952	1992	2030	2067	2106	2142	2181	2218
N60PMF	1217	1307	1361	1391	1420	1447	1476	1504	1533	1560
N60PMWF	1323	1383	1419	1439	1458	1477	1496	1514	1533	1552
N60PPF	1523	1643	1715	1755	1793	1830	1869	1905	1944	1981
N60PWF	1760	1880	1952	1992	2030	2067	2106	2142	2181	2218
N60RMF	1275	1365	1419	1449	1478	1505	1534	1562	1591	1618
N60RMWF	1323	1383	1419	1439	1458	1477	1496	1514	1533	1552
N60RRF	1580	1700	1772	1812	1850	1887	1926	1962	2001	2038
N60RWF	1760	1880	1952	1992	2030	2067	2106	2142	2181	2218
N60SAACF	717	785	825	848	869	890	911	932	954	974
N60SAAF	745	813	853	876	897	918	939	960	982	1002
N60SAWCF	971	1039	1079	1102	1123	1144	1165	1186	1208	1228
N60SAWF	1001	1069	1109	1132	1153	1174	1195	1216	1238	1258
N60SBBCF	689	757	797	820	841	862	883	904	926	946
N60SBBF	718	786	826	849	870	891	912	933	955	975
N60SBWCF	945	1013	1053	1076	1097	1118	1139	1160	1182	1202

Alliance Program TB133 Fire Rated Pricing

Finishes

IM	Brighton	CW	Cordovan
NM	Natural	DW	Judicial
HN	Honey	MH	Mocha
CL	Caramel	405	Designer White
TF	Truffle	462	Cinder
AC	Autumn	792	Sable
MC	Amber	793	Acorn

To order, specify the following:

1. Chair Model Number
2. Fabric Grade Letter
3. Alliance Pattern Number and Color Number/Name
4. Finish Number (when applicable)

Sample Order Number

<u>N14KKF</u>	<u>A</u>	<u>403901</u>	<u>036</u>	<u>HN</u>
Model Number	Fabric Grade Letter	Alliance Pattern Number	Alliance Color Number	Finish

Model Number

Alliance Program TB133 Price Grades

	A	B	C	D	E	F	G	H	I	J
N60SBWF	\$ 765	\$ 786	\$ 804	\$ 822	\$ 841	\$ 862	\$ 878	\$ 898	\$ 921	\$ 941
N60SCCF	578	601	621	641	662	686	703	726	751	773
N60SCWF	607	630	650	670	691	715	732	755	780	802
N60SCWCF	762	783	801	819	838	859	875	895	918	938
N60SCWF	792	813	831	849	868	889	905	925	948	968
N60SDDCF	550	573	593	613	634	658	675	698	723	745
N60SDDF	580	603	623	643	664	688	705	728	753	775
N60SDWCF	736	757	775	793	812	833	849	869	892	912
N60SDWF	765	786	804	822	841	862	878	898	921	941
N60SEEF	1240	1277	1309	1341	1374	1413	1440	1477	1517	1552
N60SEWF	1475	1512	1544	1576	1609	1648	1675	1712	1752	1787
N60SEMF	1027	1054	1078	1102	1127	1156	1177	1204	1234	1261
N60SEMWF	1225	1244	1260	1276	1293	1312	1325	1344	1364	1381
N60SFAF	793	814	832	850	869	890	906	926	949	969
N60SFAWF	1041	1062	1080	1098	1117	1138	1154	1174	1197	1217
N60SFBF	767	788	806	824	843	864	880	900	923	943
N60SFBWF	1015	1036	1054	1072	1091	1112	1128	1148	1171	1191
N60SFCF	863	886	906	926	947	971	988	1011	1036	1058
N60SFCWF	1041	1062	1080	1098	1117	1138	1154	1174	1197	1217
N60SDF	837	860	880	900	921	945	962	985	1010	1032
N60SDFWF	1015	1036	1054	1072	1091	1112	1128	1148	1171	1191
N60SGGF	1295	1332	1364	1396	1429	1468	1495	1532	1572	1607
N60SGWF	1475	1512	1544	1576	1609	1648	1675	1712	1752	1787
N60SGMF	1085	1112	1136	1160	1185	1214	1235	1262	1292	1319
N60SGMWF	1225	1244	1260	1276	1293	1312	1325	1344	1364	1381
N60SPMF	1027	1054	1078	1102	1127	1156	1177	1204	1234	1261
N60SPMWF	1225	1244	1260	1276	1293	1312	1325	1344	1364	1381
N60SPPF	1240	1277	1309	1341	1374	1413	1440	1477	1517	1552
N60SPPWF	1475	1512	1544	1576	1609	1648	1675	1712	1752	1787
N60SRMF	1085	1112	1136	1160	1185	1214	1235	1262	1292	1319
N60SRMWF	1225	1244	1260	1276	1293	1312	1325	1344	1364	1381
N60SRRF	1295	1332	1364	1396	1429	1468	1495	1532	1572	1607
N60SRRWF	1475	1512	1544	1576	1609	1648	1675	1712	1752	1787
N60STAF	793	814	832	850	869	890	906	926	949	969
N60STAWF	1041	1062	1080	1098	1117	1138	1154	1174	1197	1217
N60STBF	767	788	806	824	843	864	880	900	923	943
N60STBWF	1015	1036	1054	1072	1091	1112	1128	1148	1171	1191
N60STCF	863	886	906	926	947	971	988	1011	1036	1058
N60STCWF	1041	1062	1080	1098	1117	1138	1154	1174	1197	1217
N60STDF	837	860	880	900	921	945	962	985	1010	1032
N60STDWF	1015	1036	1054	1072	1091	1112	1128	1148	1171	1191
62X-AUXXF	3095	3302	3482	3662	3851	4067	4220	4427	4652	4850
62X-GUXXF	1022	1071	1114	1157	1202	1254	1290	1340	1394	1441
62X-LUXXF	2406	2558	2690	2822	2960	3119	3231	3383	3548	3693
62X-UUXXF	1849	1964	2064	2164	2269	2389	2474	2589	2714	2824
64X-GWXXF	911	942	969	996	1025	1058	1081	1112	1146	1176
N65AAAF	1812	1856	1894	1932	1972	2017	2050	2093	2141	2183

Model Number	Alliance Program TB133 Price Grades									
	K	L	M	N	O	P	Q	R	S	T
N60SBWF	\$ 974	\$ 1042	\$ 1082	\$ 1105	\$ 1126	\$ 1147	\$ 1168	\$ 1189	\$ 1211	\$ 1231
N60SCCF	810	885	930	955	979	1002	1026	1049	1073	1096
N60SCCF	839	914	959	984	1008	1031	1055	1078	1102	1125
N60SCWCF	971	1039	1079	1102	1123	1144	1165	1186	1208	1228
N60SCWF	1001	1069	1109	1132	1153	1174	1195	1216	1238	1258
N60SDDCF	782	857	902	927	951	974	998	1021	1045	1068
N60SDDF	812	887	932	957	981	1004	1028	1051	1075	1098
N60SDWCF	945	1013	1053	1076	1097	1118	1139	1160	1182	1202
N60SDWF	974	1042	1082	1105	1126	1147	1168	1189	1211	1231
N60SEEF	1611	1731	1803	1843	1881	1918	1957	1993	2032	2069
N60SEWF	1846	1966	2038	2078	2116	2153	2192	2228	2267	2304
N60SEMF	1305	1395	1449	1479	1508	1535	1564	1592	1621	1648
N60SEMWF	1411	1471	1507	1527	1546	1565	1584	1602	1621	1640
N60SFAF	1002	1070	1110	1133	1154	1175	1196	1217	1239	1259
N60SFAWF	1250	1318	1358	1381	1402	1423	1444	1465	1487	1507
N60SFBF	976	1044	1084	1107	1128	1149	1170	1191	1213	1233
N60SFBWF	1224	1292	1332	1355	1376	1397	1418	1439	1461	1481
N60SFCF	1095	1170	1215	1240	1264	1287	1311	1334	1358	1381
N60SFCWF	1250	1318	1358	1381	1402	1423	1444	1465	1487	1507
N60SFD	1069	1144	1189	1214	1238	1261	1285	1308	1332	1355
N60SFDWF	1224	1292	1332	1355	1376	1397	1418	1439	1461	1481
N60SGGF	1666	1786	1858	1898	1936	1973	2012	2048	2087	2124
N60SGWF	1846	1966	2038	2078	2116	2153	2192	2228	2267	2304
N60SGMF	1363	1453	1507	1537	1566	1593	1622	1650	1679	1706
N60SGMWF	1411	1471	1507	1527	1546	1565	1584	1602	1621	1640
N60SPMF	1305	1395	1449	1479	1508	1535	1564	1592	1621	1648
N60SPMWF	1411	1471	1507	1527	1546	1565	1584	1602	1621	1640
N60SPPF	1611	1731	1803	1843	1881	1918	1957	1993	2032	2069
N60SPWF	1846	1966	2038	2078	2116	2153	2192	2228	2267	2304
N60SRMF	1363	1453	1507	1537	1566	1593	1622	1650	1679	1706
N60SRMWF	1411	1471	1507	1527	1546	1565	1584	1602	1621	1640
N60SRRF	1666	1786	1858	1898	1936	1973	2012	2048	2087	2124
N60SRRWF	1846	1966	2038	2078	2116	2153	2192	2228	2267	2304
N60STAF	1002	1070	1110	1133	1154	1175	1196	1217	1239	1259
N60STAWF	1250	1318	1358	1381	1402	1423	1444	1465	1487	1507
N60STBF	976	1044	1084	1107	1128	1149	1170	1191	1213	1233
N60STBWF	1224	1292	1332	1355	1376	1397	1418	1439	1461	1481
N60STCF	1095	1170	1215	1240	1264	1287	1311	1334	1358	1381
N60STCWF	1250	1318	1358	1381	1402	1423	1444	1465	1487	1507
N60STDF	1069	1144	1189	1214	1238	1261	1285	1308	1332	1355
N60STDWF	1224	1292	1332	1355	1376	1397	1418	1439	1461	1481
62X-AUXXF	5183	5858	6263	6488	6704	6911	7127	7334	7550	7757
62X-GUXXF	1521	1682	1779	1832	1884	1933	1985	2034	2086	2135
62X-LUXXF	3937	4432	4729	4894	5052	5204	5363	5514	5673	5825
62X-UUXXF	3009	3384	3609	3734	3854	3969	4089	4204	4324	4439
64X-GWXXF	1226	1328	1389	1423	1456	1487	1520	1551	1584	1615
N65AAAF	2253	2396	2481	2529	2574	2618	2663	2707	2753	2796

Alliance Program TB133 Fire Rated Pricing

Finishes

IM	Brighton	CW	Cordovan
NM	Natural	DW	Judicial
HN	Honey	MH	Mocha
CL	Caramel	405	Designer White
TF	Truffle	462	Cinder
AC	Autumn	792	Sable
MC	Amber	793	Acorn

To order, specify the following:

1. Chair Model Number
2. Fabric Grade Letter
3. Alliance Pattern Number and Color Number/Name
4. Finish Number (when applicable)

Sample Order Number

<u>N14KKF</u>	<u>A</u>	<u>403901</u>	<u>036</u>	<u>HN</u>
Model Number	Fabric Grade Letter	Alliance Pattern Number	Alliance Color Number	Finish

Model Number

Alliance Program TB133 Price Grades

	A	B	C	D	E	F	G	H	I	J
N65AAPF	\$ 1637	\$ 1681	\$ 1719	\$ 1757	\$ 1797	\$ 1842	\$ 1875	\$ 1918	\$ 1966	\$ 2008
N65AASAF	1904	1948	1986	2024	2064	2109	2142	2185	2233	2275
N65AASPF	1728	1772	1810	1848	1888	1933	1966	2009	2057	2099
N65BBAF	1741	1783	1819	1855	1893	1936	1966	2008	2053	2092
N65BBPF	1565	1607	1643	1679	1717	1760	1790	1832	1877	1916
N65BBSAF	1832	1874	1910	1946	1984	2027	2057	2099	2144	2183
N65BBSPF	1656	1698	1734	1770	1808	1851	1881	1923	1968	2007
N65CCAF	1724	1768	1806	1844	1884	1929	1962	2005	2053	2095
N65CCPF	1548	1592	1630	1668	1708	1753	1786	1829	1877	1919
N65CCSAF	1815	1859	1897	1935	1975	2020	2053	2096	2144	2186
N65CCSPF	1641	1685	1723	1761	1801	1846	1879	1922	1970	2012
N65DDAF	1653	1695	1731	1767	1805	1848	1878	1920	1965	2004
N65DDPF	1478	1520	1556	1592	1630	1673	1703	1745	1790	1829
N65DDSAF	1744	1786	1822	1858	1896	1939	1969	2011	2056	2095
N65DDSPF	1568	1610	1646	1682	1720	1763	1793	1835	1880	1919
N65EEAF	1186	1209	1229	1249	1270	1294	1311	1334	1359	1381
N65EEPF	1082	1105	1125	1145	1166	1190	1207	1230	1255	1277
N65GGAF	1241	1264	1284	1304	1325	1349	1366	1389	1414	1436
N65GGPF	1136	1159	1179	1199	1220	1244	1261	1284	1309	1331
N66RD16CF	618	643	665	687	710	737	755	781	808	832
N66RD16CXF										
N66RD16GF	598	623	645	667	690	717	735	761	788	812
N66RD16GXF										
N66RD18CF	675	703	726	750	775	804	824	851	881	907
N66RD18GF	655	683	706	730	755	784	804	831	861	887
N66RD22CF	732	762	788	814	842	873	896	926	958	987
N66RD22GF	711	741	767	793	821	852	875	905	937	966
N66SQ16CF	644	669	691	713	736	763	781	807	834	858
N66SQ16CXF										
N66SQ16GF	623	648	670	692	715	742	760	786	813	837
N66SQ16GXF										
N66SQ18CF	772	813	850	886	924	967	998	1040	1085	1125
N66SQ18GF	751	792	829	865	903	946	977	1019	1064	1104
N66SQ22CF	823	866	904	942	982	1027	1059	1103	1150	1191
N66SQ22GF	803	846	884	922	962	1007	1039	1083	1130	1171
N66TZ16CF	714	737	757	777	798	822	839	862	887	909
N66TZ16CXF										
N66TZ16GF	694	717	737	757	778	802	819	842	867	889
N66TZ16GXF										
N66TZ18CF	809	834	856	878	901	928	946	972	999	1023
N66TZ18CXF										
N66TZ18GF	788	813	835	857	880	907	925	951	978	1002
N66TZ18GXF										
N66TZ22CF	887	919	947	975	1005	1038	1062	1094	1129	1160
N66TZ22CXF										
N66TZ22GF	866	898	926	954	984	1017	1041	1073	1108	1139

Model Number	Alliance Program TB133 Price Grades									
	K	L	M	N	O	P	Q	R	S	T
N65AAPF	\$ 2078	\$ 2221	\$ 2306	\$ 2354	\$ 2399	\$ 2443	\$ 2488	\$ 2532	\$ 2578	\$ 2621
N65AASAF	2345	2488	2573	2621	2666	2710	2755	2799	2845	2888
N65AASPF	2169	2312	2397	2445	2490	2534	2579	2623	2669	2712
N65BBAF	2159	2294	2375	2420	2463	2505	2548	2589	2632	2674
N65BBPF	1983	2118	2199	2244	2287	2329	2372	2413	2456	2498
N65BBSAF	2250	2385	2466	2511	2554	2596	2639	2680	2723	2765
N65BBSPF	2074	2209	2290	2335	2378	2420	2463	2504	2547	2589
N65CCAF	2165	2308	2393	2441	2486	2530	2575	2619	2665	2708
N65CCPF	1989	2132	2217	2265	2310	2354	2399	2443	2489	2532
N65CCSAF	2256	2399	2484	2532	2577	2621	2666	2710	2756	2799
N65CCSPF	2082	2225	2310	2358	2403	2447	2492	2536	2582	2625
N65DDAF	2071	2206	2287	2332	2375	2417	2460	2501	2544	2586
N65DDPF	1896	2031	2112	2157	2200	2242	2285	2326	2369	2411
N65DDSAF	2162	2297	2378	2423	2466	2508	2551	2592	2635	2677
N65DDSPF	1986	2121	2202	2247	2290	2332	2375	2416	2459	2501
N65EEAF	1418	1493	1538	1563	1587	1610	1634	1657	1681	1704
N65EEPF	1314	1389	1434	1459	1483	1506	1530	1553	1577	1600
N65GGAF	1473	1548	1593	1618	1642	1665	1689	1712	1736	1759
N65GGPF	1368	1443	1488	1513	1537	1560	1584	1607	1631	1654
N66RD16CF	873	956	1005	1033	1059	1084	1111	1136	1162	1188
N66RD16CXF										
N66RD16GF	853	936	985	1013	1039	1064	1091	1116	1142	1168
N66RD16GXF										
N66RD18CF	951	1041	1094	1124	1152	1180	1208	1236	1264	1292
N66RD18GF	931	1021	1074	1104	1132	1160	1188	1216	1244	1272
N66RD22CF	1036	1134	1193	1226	1257	1287	1319	1349	1380	1410
N66RD22GF	1015	1113	1172	1205	1236	1266	1298	1328	1359	1389
N66SQ16CF	899	982	1031	1059	1085	1110	1137	1162	1188	1214
N66SQ16CXF										
N66SQ16GF	878	961	1010	1038	1064	1089	1116	1141	1167	1193
N66SQ16GXF										
N66SQ18CF	1192	1327	1409	1454	1498	1539	1583	1624	1668	1709
N66SQ18GF	1171	1306	1388	1433	1477	1518	1562	1603	1647	1688
N66SQ22CF	1261	1403	1488	1535	1581	1624	1670	1713	1758	1802
N66SQ22GF	1241	1383	1468	1515	1561	1604	1650	1693	1738	1782
N66TZ16CF	946	1021	1066	1091	1115	1138	1162	1185	1209	1232
N66TZ16CXF										
N66TZ16GF	926	1001	1046	1071	1095	1118	1142	1165	1189	1212
N66TZ16GXF										
N66TZ18CF	1064	1147	1196	1224	1250	1275	1302	1327	1353	1379
N66TZ18CXF										
N66TZ18GF	1043	1126	1175	1203	1229	1254	1281	1306	1332	1358
N66TZ18GXF										
N66TZ22CF	1212	1317	1380	1415	1449	1481	1514	1547	1580	1612
N66TZ22CXF										
N66TZ22GF	1191	1296	1359	1394	1428	1460	1493	1526	1559	1591

Alliance Program TB133 Fire Rated Pricing

Finishes

IM	Brighton	CW	Cordovan
NM	Natural	DW	Judicial
HN	Honey	MH	Mocha
CL	Caramel	405	Designer White
TF	Truffle	462	Cinder
AC	Autumn	792	Sable
MC	Amber	793	Acorn

To order, specify the following:

1. Chair Model Number
2. Fabric Grade Letter
3. Alliance Pattern Number and Color Number/Name
4. Finish Number (when applicable)

Sample Order Number

<u>N14KKF</u>	<u>A</u>	<u>403901</u>	<u>036</u>	<u>HN</u>
Model Number	Fabric Grade Letter	Alliance Pattern Number	Alliance Color Number	Finish

Model Number

Alliance Program TB133 Price Grades

	A	B	C	D	E	F	G	H	I	J
N66TZ22GXF	\$	\$	\$	\$	\$	\$	\$	\$	\$	\$
N67AACF										
N67BBCF										
N67BBCJF										
N67CCCF										
N67DDCF										
N67DDCJF										
N67EEF										
N68AACF										
N68BBCF										
N68BBCJF										
N68CCCF										
N68DDCF										
N68DDCJF										
N68EEF										
N69AACF										
N69BBCF										
N69BBCJF										
N69CCCF										
N69DDCF										
N69DDCJF										
N69EEF										
72X-GUXTF	819	846	870	894	919	948	969	996	1026	1053
72X-GUXXF	815	842	866	890	915	944	965	992	1022	1049
N75BACF	1215	1268	1314	1360	1409	1464	1503	1556	1613	1664
N75BBCF	1394	1447	1493	1539	1588	1643	1682	1735	1792	1843
N75BCCF	1177	1227	1271	1315	1361	1414	1452	1502	1557	1606
N75BDCF	1358	1408	1452	1496	1542	1595	1633	1683	1738	1787
N75SACF	1365	1418	1464	1510	1559	1614	1653	1706	1763	1814
N75SBCF	1473	1526	1572	1618	1667	1722	1761	1814	1871	1922
N75SCCF	1326	1376	1420	1464	1510	1563	1601	1651	1706	1755
N75SDCF	1434	1484	1528	1572	1618	1671	1709	1759	1814	1863
N75SPCF	1255	1305	1349	1393	1439	1492	1530	1580	1635	1684
N75SSCF	1292	1345	1391	1437	1486	1541	1580	1633	1690	1741
N75WSF	893	923	949	975	1003	1034	1056	1086	1118	1147
N78AFLAUF	1364	1399	1429	1459	1490	1526	1552	1586	1624	1657
N78AFLAWF	1492	1524	1552	1580	1610	1643	1667	1699	1734	1765
N78AFLMUF	1280	1315	1345	1375	1406	1442	1468	1502	1540	1573
N78AFLMWF	1409	1441	1469	1497	1527	1560	1584	1616	1651	1682
N78AFRAUF	1364	1399	1429	1459	1490	1526	1552	1586	1624	1657
N78AFRAWF	1492	1524	1552	1580	1610	1643	1667	1699	1734	1765
N78AFRMUF	1280	1315	1345	1375	1406	1442	1468	1502	1540	1573
N78AFRMWF	1409	1441	1469	1497	1527	1560	1584	1616	1651	1682
N78B2AUF	2817	2882	2938	2994	3053	3120	3167	3232	3302	3363
N78B2AWF	3051	3106	3154	3202	3253	3310	3351	3406	3466	3519
N78B2EUF	2760	2825	2881	2937	2996	3063	3110	3175	3245	3306
N78B2EWF	2994	3049	3097	3145	3196	3253	3294	3349	3409	3462

Model Number	Alliance Program TB133 Price Grades									
	K	L	M	N	O	P	Q	R	S	T
N66TZ22GXF	\$	\$	\$	\$	\$	\$	\$	\$	\$	\$
N67AACF										
N67BBCF										
N67BBCJF										
N67CCCF										
N67DDCF										
N67DDCJF										
N67EEF										
N68AACF										
N68BBCF										
N68BBCJF										
N68CCCF										
N68DDCF										
N68DDCJF										
N68EEF										
N69AACF										
N69BBCF										
N69BBCJF										
N69CCCF										
N69DDCF										
N69DDCJF										
N69EEF										
72X-GUXTF	1097	1187	1241	1271	1300	1327	1356	1384	1413	1440
72X-GUXXF	1093	1183	1237	1267	1296	1323	1352	1380	1409	1436
N75BACF	1749	1922	2025	2083	2138	2191	2246	2299	2354	2407
N75BBCF	1928	2101	2204	2262	2317	2370	2425	2478	2533	2586
N75BCCF	1687	1852	1951	2006	2059	2109	2162	2213	2266	2316
N75BDCF	1868	2033	2132	2187	2240	2290	2343	2394	2447	2497
N75SACF	1899	2072	2175	2233	2288	2341	2396	2449	2504	2557
N75SBCF	2007	2180	2283	2341	2396	2449	2504	2557	2612	2665
N75SCCF	1836	2001	2100	2155	2208	2258	2311	2362	2415	2465
N75SDCF	1944	2109	2208	2263	2316	2366	2419	2470	2523	2573
N75SPCF	1765	1930	2029	2084	2137	2187	2240	2291	2344	2394
N75SSCF	1826	1999	2102	2160	2215	2268	2323	2376	2431	2484
N75WSF	1195	1293	1351	1384	1415	1445	1476	1506	1537	1567
N78AFLAUF	1712	1825	1892	1930	1966	2000	2036	2071	2107	2141
N78AFLAWF	1817	1922	1985	2020	2054	2086	2119	2152	2185	2217
N78AFLMUF	1628	1741	1808	1846	1882	1916	1952	1987	2023	2057
N78AFLMWF	1734	1839	1902	1937	1971	2003	2036	2069	2102	2134
N78AFRAUF	1712	1825	1892	1930	1966	2000	2036	2071	2107	2141
N78AFRAWF	1817	1922	1985	2020	2054	2086	2119	2152	2185	2217
N78AFRMUF	1628	1741	1808	1846	1882	1916	1952	1987	2023	2057
N78AFRMWF	1734	1839	1902	1937	1971	2003	2036	2069	2102	2134
N78B2AUF	3467	3677	3803	3873	3940	4005	4072	4136	4203	4268
N78B2AWF	3608	3788	3896	3956	4014	4069	4126	4182	4239	4294
N78B2EUF	3410	3620	3746	3816	3883	3948	4015	4079	4146	4211
N78B2EWF	3551	3731	3839	3899	3957	4012	4069	4125	4182	4237

Alliance Program TB133 Fire Rated Pricing

Finishes

IM	Brighton	CW	Cordovan
NM	Natural	DW	Judicial
HN	Honey	MH	Mocha
CL	Caramel	405	Designer White
TF	Truffle	462	Cinder
AC	Autumn	792	Sable
MC	Amber	793	Acorn

To order, specify the following:

1. Chair Model Number
2. Fabric Grade Letter
3. Alliance Pattern Number and Color Number/Name
4. Finish Number (when applicable)

Sample Order Number

<u>N14KKF</u>	<u>A</u>	<u>403901</u>	<u>036</u>	<u>HN</u>
Model Number	Fabric Grade Letter	Alliance Pattern Number	Alliance Color Number	Finish

Model Number

Alliance Program TB133 Price Grades

	A	B	C	D	E	F	G	H	I	J
N78B3AUF	\$ 4158	\$ 4252	\$ 4334	\$ 4416	\$ 4502	\$ 4601	\$ 4670	\$ 4765	\$ 4867	\$ 4957
N78B3AWF	4532	4617	4691	4765	4842	4931	4994	5079	5172	5253
N78B3EUF	4102	4196	4278	4360	4446	4545	4614	4709	4811	4901
N78B3EWF	4475	4560	4634	4708	4785	4874	4937	5022	5115	5196
N78D1MF	1063	1088	1110	1132	1155	1182	1200	1226	1253	1277
N78D2AF	1795	1837	1873	1909	1947	1990	2020	2062	2107	2146
N78D2MF	1400	1442	1478	1514	1552	1595	1625	1667	1712	1751
N78D3AF	2266	2316	2360	2404	2450	2503	2541	2591	2646	2695
N78D3MF	1845	1895	1939	1983	2029	2082	2120	2170	2225	2274
N78GEAUF	2141	2189	2231	2273	2317	2368	2403	2452	2504	2550
N78GEAWF	2315	2359	2397	2435	2475	2520	2553	2596	2644	2686
N78GFAUF	1392	1427	1457	1487	1518	1554	1580	1614	1652	1685
N78GFAWF	1521	1553	1581	1609	1639	1672	1696	1728	1763	1794
N78GFUF	1309	1344	1374	1404	1435	1471	1497	1531	1569	1602
N78GFUWF	1438	1470	1498	1526	1556	1589	1613	1645	1680	1711
N78LAAAUBF	5374	5549	5701	5853	6012	6195	6324	6499	6689	6856
N78LAAUUF	4866	5041	5193	5345	5504	5687	5816	5991	6181	6348
N78LAAAULF	5120	5295	5447	5599	5758	5941	6070	6245	6435	6602
N78LAAAURF	5120	5295	5447	5599	5758	5941	6070	6245	6435	6602
N78LAAAWBF	5811	5986	6138	6290	6449	6632	6761	6936	7126	7293
N78LAAAWF	5306	5481	5633	5785	5944	6127	6256	6431	6621	6788
N78LAAAWLF	5558	5733	5885	6037	6196	6379	6508	6683	6873	7040
N78LAAAWRF	5558	5733	5885	6037	6196	6379	6508	6683	6873	7040
N78LAAUBF	4092	4216	4324	4432	4546	4675	4767	4891	5026	5145
N78LAAUUF	3585	3709	3817	3925	4039	4168	4260	4384	4519	4638
N78LAAULF	3839	3963	4071	4179	4293	4422	4514	4638	4773	4892
N78LAAURF	3839	3963	4071	4179	4293	4422	4514	4638	4773	4892
N78LAAWBF	4336	4453	4555	4657	4764	4887	4973	5091	5218	5330
N78LAAWF	3830	3947	4049	4151	4258	4381	4467	4585	4712	4824
N78LAAWLF	4083	4200	4302	4404	4511	4634	4720	4838	4965	5077
N78LAAWRF	4083	4200	4302	4404	4511	4634	4720	4838	4965	5077
N78LAUF	2361	2434	2498	2562	2629	2706	2761	2834	2914	2985
N78LAULF	2614	2687	2751	2815	2882	2959	3014	3087	3167	3238
N78LAURF	2614	2687	2751	2815	2882	2959	3014	3087	3167	3238
N78LAWF	2476	2545	2605	2665	2728	2800	2851	2920	2995	3061
N78LAWLF	2730	2799	2859	2919	2982	3054	3105	3174	3249	3315
N78LAWRF	2730	2799	2859	2919	2982	3054	3105	3174	3249	3315
N78LBUBF	3641	3749	3843	3937	4035	4148	4228	4336	4454	4557
N78LBUF	3134	3242	3336	3430	3528	3641	3721	3829	3947	4050
N78LBULF	3388	3496	3590	3684	3782	3895	3975	4083	4201	4304
N78LBURF	3388	3496	3590	3684	3782	3895	3975	4083	4201	4304
N78LBWBF	3886	3987	4075	4163	4256	4361	4436	4537	4647	4744
N78LBWF	3379	3480	3568	3656	3749	3854	3929	4030	4140	4237
N78LBWLF	3633	3734	3822	3910	4003	4108	4183	4284	4394	4491
N78LBWRF	3633	3734	3822	3910	4003	4108	4183	4284	4394	4491
N78LCUBF	4495	4642	4770	4898	5033	5186	5295	5442	5602	5743
N78LCUF	3989	4136	4264	4392	4527	4680	4789	4936	5096	5237

Model Number	Alliance Program TB133 Price Grades									
	K	L	M	N	O	P	Q	R	S	T
N78B3AUF	\$ 5109	\$ 5417	\$ 5601	\$ 5704	\$ 5802	\$ 5896	\$ 5995	\$ 6089	\$ 6187	\$ 6282
N78B3AWF	5390	5668	5834	5927	6015	6100	6189	6274	6363	6448
N78B3EUF	5053	5361	5545	5648	5746	5840	5939	6033	6131	6226
N78B3EWF	5333	5611	5777	5870	5958	6043	6132	6217	6306	6391
N78D1MF	1318	1401	1450	1478	1504	1529	1556	1581	1607	1633
N78D2AF	2213	2348	2429	2474	2517	2559	2602	2643	2686	2728
N78D2MF	1818	1953	2034	2079	2122	2164	2207	2248	2291	2333
N78D3AF	2776	2941	3040	3095	3148	3198	3251	3302	3355	3405
N78D3MF	2355	2520	2619	2674	2727	2777	2830	2881	2934	2984
N78GEAUF	2628	2786	2880	2933	2983	3031	3082	3130	3180	3229
N78GEAWF	2756	2899	2984	3032	3077	3121	3166	3210	3256	3299
N78GFAUF	1740	1853	1920	1958	1994	2028	2064	2099	2135	2169
N78GFAWF	1846	1951	2014	2049	2083	2115	2148	2181	2214	2246
N78GFMUF	1657	1770	1837	1875	1911	1945	1981	2016	2052	2086
N78GFMWF	1763	1868	1931	1966	2000	2032	2065	2098	2131	2163
N78LAAAUBF	7137	7707	8049	8239	8421	8596	8779	8953	9136	9311
N78LAAAUF	6629	7199	7541	7731	7913	8088	8271	8445	8628	8803
N78LAAULF	6883	7453	7795	7985	8167	8342	8525	8699	8882	9057
N78LAAURF	6883	7453	7795	7985	8167	8342	8525	8699	8882	9057
N78LAAWBF	7574	8144	8486	8676	8858	9033	9216	9390	9573	9748
N78LAAWRF	7069	7639	7981	8171	8353	8528	8711	8885	9068	9243
N78LAAWLF	7321	7891	8233	8423	8605	8780	8963	9137	9320	9495
N78LAAWRF	7321	7891	8233	8423	8605	8780	8963	9137	9320	9495
N78LAAUBF	5345	5750	5993	6128	6258	6382	6511	6636	6765	6889
N78LAAUF	4838	5243	5486	5621	5751	5875	6004	6129	6258	6382
N78LAAULF	5092	5497	5740	5875	6005	6129	6258	6383	6512	6636
N78LAAURF	5092	5497	5740	5875	6005	6129	6258	6383	6512	6636
N78LAAWBF	5519	5902	6131	6259	6381	6498	6621	6738	6860	6978
N78LAAWF	5013	5396	5625	5753	5875	5992	6115	6232	6354	6472
N78LAAWLF	5266	5649	5878	6006	6128	6245	6368	6485	6607	6725
N78LAAWRF	5266	5649	5878	6006	6128	6245	6368	6485	6607	6725
N78LAUF	3103	3343	3487	3567	3644	3717	3794	3868	3945	4018
N78LAULF	3356	3596	3740	3820	3897	3970	4047	4121	4198	4271
N78LAURF	3356	3596	3740	3820	3897	3970	4047	4121	4198	4271
N78LAWF	3172	3397	3532	3607	3679	3748	3820	3889	3961	4030
N78LAWLF	3426	3651	3786	3861	3933	4002	4074	4143	4215	4284
N78LAWRF	3426	3651	3786	3861	3933	4002	4074	4143	4215	4284
N78LBUBF	4731	5084	5295	5413	5525	5633	5746	5854	5967	6075
N78LBUF	4224	4577	4788	4906	5018	5126	5239	5347	5460	5568
N78LBULF	4478	4831	5042	5160	5272	5380	5493	5601	5714	5822
N78LBURF	4478	4831	5042	5160	5272	5380	5493	5601	5714	5822
N78LBWBF	4907	5237	5435	5545	5651	5752	5857	5959	6064	6165
N78LBWF	4400	4730	4928	5038	5144	5245	5350	5452	5557	5658
N78LBWLF	4654	4984	5182	5292	5398	5499	5604	5706	5811	5912
N78LBWRF	4654	4984	5182	5292	5398	5499	5604	5706	5811	5912
N78LCUBF	5980	6460	6748	6908	7062	7209	7362	7510	7663	7810
N78LCUF	5474	5954	6242	6402	6556	6703	6856	7004	7157	7304

Alliance Program TB133 Fire Rated Pricing

Finishes

IM	Brighton	CW	Cordovan
NM	Natural	DW	Judicial
HN	Honey	MH	Mocha
CL	Caramel	405	Designer White
TF	Truffle	462	Cinder
AC	Autumn	792	Sable
MC	Amber	793	Acorn

To order, specify the following:

1. Chair Model Number
2. Fabric Grade Letter
3. Alliance Pattern Number and Color Number/Name
4. Finish Number (when applicable)

Sample Order Number

<u>N14KKF</u>	<u>A</u>	<u>403901</u>	<u>036</u>	<u>HN</u>
Model Number	Fabric Grade Letter	Alliance Pattern Number	Alliance Color Number	Finish

Model Number

Alliance Program TB133 Price Grades

	A	B	C	D	E	F	G	H	I	J
N78LCULF	\$ 4242	\$ 4389	\$ 4517	\$ 4645	\$ 4780	\$ 4933	\$ 5042	\$ 5189	\$ 5349	\$ 5490
N78LCURF	4242	4389	4517	4645	4780	4933	5042	5189	5349	5490
N78LCWBF	4925	5065	5187	5309	5437	5584	5687	5828	5980	6114
N78LCWF	4419	4559	4681	4803	4931	5078	5181	5322	5474	5608
N78LCWLF	4672	4812	4934	5056	5184	5331	5434	5575	5727	5861
N78LCWRF	4672	4812	4934	5056	5184	5331	5434	5575	5727	5861
N78LEUF	2695	2789	2871	2953	3039	3138	3207	3302	3404	3494
N78LEWF	2856	2944	3020	3096	3176	3267	3331	3419	3514	3597
N78PAUF	1627	1669	1705	1741	1779	1822	1852	1894	1939	1978
N78SFAUF	1504	1539	1569	1599	1630	1666	1692	1726	1764	1797
N78SFAWF	1634	1666	1694	1722	1752	1785	1809	1841	1876	1907
N78SFMUF	1421	1456	1486	1516	1547	1583	1609	1643	1681	1714
N78SFMWF	1550	1582	1610	1638	1668	1701	1725	1757	1792	1823
N78T2AUF	2788	2853	2909	2965	3024	3091	3138	3203	3273	3334
N78T2AWF	3023	3078	3126	3174	3225	3282	3323	3378	3438	3491
N78T3AUF	4131	4225	4307	4389	4475	4574	4643	4738	4840	4930
N78T3AWF	4504	4589	4663	4737	4814	4903	4966	5051	5144	5225
N79AACF	1128	1172	1210	1248	1288	1333	1366	1409	1457	1499
N79AACJF	1353	1397	1435	1473	1513	1558	1591	1634	1682	1724
N79BBCF	1073	1112	1146	1180	1215	1256	1285	1324	1367	1404
N79BBCJF	1298	1337	1371	1405	1440	1481	1510	1549	1592	1629
N79CCF	906	945	979	1013	1048	1089	1118	1157	1200	1237
N85CACF	1516	1555	1589	1623	1658	1699	1728	1767	1810	1847
N85CBCF	1463	1500	1532	1564	1597	1636	1663	1700	1740	1775
N85LAF	2392	2457	2513	2569	2628	2695	2742	2807	2877	2938
N85LATF	2509	2574	2630	2686	2745	2812	2859	2924	2994	3055
N85LBF	3086	3179	3259	3340	3425	3521	3590	3683	3783	3872
N85LBTF	3203	3296	3376	3457	3542	3638	3707	3800	3900	3989
N85LCF	3834	3953	4057	4161	4270	4395	4484	4603	4733	4848
N85LCTF	3952	4071	4175	4279	4388	4513	4602	4721	4851	4966
N85LDF	1943	2001	2051	2101	2153	2213	2256	2313	2376	2431
N85LDTF	2060	2118	2168	2218	2270	2330	2373	2430	2493	2548
N85SAAAF	2692	2750	2800	2850	2902	2962	3005	3062	3125	3180
N85SAAATF	2864	2922	2972	3022	3074	3134	3177	3234	3297	3352
N85SAAF	1786	1823	1855	1887	1920	1959	1986	2023	2063	2098
N85SAATF	1916	1953	1985	2017	2050	2089	2116	2153	2193	2228
N85SACAF	2749	2804	2852	2900	2951	3008	3049	3104	3164	3217
N85SACATF	2921	2976	3024	3072	3123	3180	3221	3276	3336	3389
N85SAF	966	985	1001	1017	1034	1053	1066	1085	1105	1122
N85SATF	1052	1071	1087	1103	1120	1139	1152	1171	1191	1208
N85SBF	1054	1079	1101	1123	1146	1173	1191	1217	1244	1268
N85SBTF	1139	1164	1186	1208	1231	1258	1276	1302	1329	1353
N85SCF	1035	1054	1070	1086	1103	1122	1135	1154	1174	1191
N85SCTF	1122	1141	1157	1173	1190	1209	1222	1241	1261	1278
N85SEF	1867	1911	1949	1987	2027	2072	2105	2148	2196	2238
N85SETF	1954	1998	2036	2074	2114	2159	2192	2235	2283	2325
88X-ENFXCF										

Model Number	Alliance Program TB133 Price Grades									
	K	L	M	N	O	P	Q	R	S	T
N78LCULF	\$ 5727	\$ 6207	\$ 6495	\$ 6655	\$ 6809	\$ 6956	\$ 7109	\$ 7257	\$ 7410	\$ 7557
N78LCURF	5727	6207	6495	6655	6809	6956	7109	7257	7410	7557
N78LCWBF	6340	6798	7072	7225	7371	7511	7658	7798	7944	8085
N78LCWF	5834	6292	6566	6719	6865	7005	7152	7292	7438	7579
N78LCWLF	6087	6545	6819	6972	7118	7258	7405	7545	7691	7832
N78LCWRF	6087	6545	6819	6972	7118	7258	7405	7545	7691	7832
N78LEUF	3646	3954	4138	4241	4339	4433	4532	4626	4724	4819
N78LEWF	3738	4023	4194	4289	4380	4468	4559	4646	4737	4825
N78PAUF	2045	2180	2261	2306	2349	2391	2434	2475	2518	2560
N78SFAUF	1852	1965	2032	2070	2106	2140	2176	2211	2247	2281
N78SFAWF	1959	2064	2127	2162	2196	2228	2261	2294	2327	2359
N78SFMUF	1769	1882	1949	1987	2023	2057	2093	2128	2164	2198
N78SFMWF	1875	1980	2043	2078	2112	2144	2177	2210	2243	2275
N78T2AUF	3438	3648	3774	3844	3911	3976	4043	4107	4174	4239
N78T2AWF	3580	3760	3868	3928	3986	4041	4098	4154	4211	4266
N78T3AUF	5082	5390	5574	5677	5775	5869	5968	6062	6160	6255
N78T3AWF	5362	5640	5806	5899	5987	6072	6161	6246	6335	6420
N79AACF	1569	1712	1797	1845	1890	1934	1979	2023	2069	2112
N79AACJF	1794	1937	2022	2070	2115	2159	2204	2248	2294	2337
N79BBCF	1467	1595	1671	1714	1754	1793	1834	1873	1914	1953
N79BBCJF	1692	1820	1896	1939	1979	2018	2059	2098	2139	2178
N79CCF	1300	1428	1504	1547	1587	1626	1667	1706	1747	1786
N85CACF	1910	2038	2114	2157	2197	2236	2277	2316	2357	2396
N85CBCF	1834	1954	2026	2066	2104	2141	2180	2216	2255	2292
N85LAF	3042	3252	3378	3448	3515	3580	3647	3711	3778	3843
N85LATF	3159	3369	3495	3565	3632	3697	3764	3828	3895	3960
N85LBF	4021	4323	4505	4605	4702	4795	4892	4984	5081	5174
N85LBTF	4138	4440	4622	4722	4819	4912	5009	5101	5198	5291
N85LCF	5040	5430	5664	5794	5919	6038	6163	6283	6408	6527
N85LCTF	5158	5548	5782	5912	6037	6156	6281	6401	6526	6645
N85LDF	2523	2711	2823	2886	2946	3003	3063	3121	3181	3238
N85LDTF	2640	2828	2940	3003	3063	3120	3180	3238	3298	3355
N85SAAAF	3272	3460	3572	3635	3695	3752	3812	3870	3930	3987
N85SAAATF	3444	3632	3744	3807	3867	3924	3984	4042	4102	4159
N85SAAF	2157	2277	2349	2389	2427	2464	2503	2539	2578	2615
N85SAATF	2287	2407	2479	2519	2557	2594	2633	2669	2708	2745
N85SACAF	3306	3486	3594	3654	3712	3767	3824	3880	3937	3992
N85SACATF	3478	3658	3766	3826	3884	3939	3996	4052	4109	4164
N85SAF	1152	1212	1248	1268	1287	1306	1325	1343	1362	1381
N85SATF	1238	1298	1334	1354	1373	1392	1411	1429	1448	1467
N85SBF	1309	1392	1441	1469	1495	1520	1547	1572	1598	1624
N85SBTF	1394	1477	1526	1554	1580	1605	1632	1657	1683	1709
N85SCF	1221	1281	1317	1337	1356	1375	1394	1412	1431	1450
N85SCTF	1308	1368	1404	1424	1443	1462	1481	1499	1518	1537
N85SEF	2308	2451	2536	2584	2629	2673	2718	2762	2808	2851
N85SETF	2395	2538	2623	2671	2716	2760	2805	2849	2895	2938
88X-ENFXCF										

Alliance Program TB133 Fire Rated Pricing

Finishes

IM	Brighton	CW	Cordovan
NM	Natural	DW	Judicial
HN	Honey	MH	Mocha
CL	Caramel	405	Designer White
TF	Truffle	462	Cinder
AC	Autumn	792	Sable
MC	Amber	793	Acorn

To order, specify the following:

1. Chair Model Number
2. Fabric Grade Letter
3. Alliance Pattern Number and Color Number/Name
4. Finish Number (when applicable)

Sample Order Number

<u>N14KKF</u>	<u>A</u>	<u>403901</u>	<u>036</u>	<u>HN</u>
Model Number	Fabric Grade Letter	Alliance Pattern Number	Alliance Color Number	Finish

Model Number

Alliance Program TB133 Price Grades

	A	B	C	D	E	F	G	H	I	J
88X-ENFXCF	\$	\$	\$	\$	\$	\$	\$	\$	\$	\$
88X-GMXXF										
88X-GRXXF										
88X-MNFXCF										
88X-MNFXCF										
88X-MRFXCF										
88X-MRFXCF										
89X-EUEXCF	1299	1348	1391	1434	1479	1531	1567	1617	1671	1718
89X-EUFXCF	1220	1269	1312	1355	1400	1452	1488	1538	1592	1639
89X-EUFXCJF	1445	1494	1537	1580	1625	1677	1713	1763	1817	1864
89X-EWECCF	1413	1455	1491	1527	1565	1608	1638	1680	1725	1764
89X-EWECCJF	1638	1680	1716	1752	1790	1833	1863	1905	1950	1989
89X-EWEXCF	1353	1395	1431	1467	1505	1548	1578	1620	1665	1704
89X-EWEXCJF	1578	1620	1656	1692	1730	1773	1803	1845	1890	1929
89X-GWXXF	925	960	990	1020	1051	1087	1113	1147	1185	1218
89X-MUEXCF	1255	1301	1341	1381	1423	1471	1505	1551	1601	1645
89X-MUFXCF	1176	1222	1262	1302	1344	1392	1426	1472	1522	1566
89X-MUFXCJF	1401	1447	1487	1527	1569	1617	1651	1697	1747	1791
89X-MWECCF	1360	1397	1429	1461	1494	1533	1560	1597	1637	1672
89X-MWECCJF	1585	1622	1654	1686	1719	1758	1785	1822	1862	1897
89X-MWEXCF	1300	1337	1369	1401	1434	1473	1500	1537	1577	1612
89X-MWEXCJF	1525	1562	1594	1626	1659	1698	1725	1762	1802	1837
N90AAF	2507	2618	2714	2810	2911	3026	3107	3218	3338	3443
N90BBF	3443	3634	3800	3966	4141	4340	4481	4672	4879	5062
N90CCF	4107	4316	4498	4680	4871	5090	5244	5454	5681	5881
N92B1F	1571	1633	1687	1741	1797	1862	1908	1970	2038	2097
N92B2F	2176	2277	2365	2453	2546	2651	2726	2827	2937	3034
N92B3F	2781	2921	3043	3165	3293	3440	3543	3684	3836	3970
N92B9F	2152	2219	2277	2335	2396	2465	2515	2581	2654	2718
N92CSACF	2469	2550	2620	2690	2763	2847	2907	2987	3075	3152
N92CSAF	2469	2550	2620	2690	2763	2847	2907	2987	3075	3152
N92CSALCF	2708	2789	2859	2929	3002	3086	3146	3226	3314	3391
N92CSALF	2708	2789	2859	2929	3002	3086	3146	3226	3314	3391
N92CSARCF	2708	2789	2859	2929	3002	3086	3146	3226	3314	3391
N92CSARF	2708	2789	2859	2929	3002	3086	3146	3226	3314	3391
N92CSLLCF	2381	2446	2502	2558	2617	2684	2731	2796	2866	2927
N92CSLLF	2381	2446	2502	2558	2617	2684	2731	2796	2866	2927
N92CSMCF	1858	1913	1961	2009	2060	2117	2158	2213	2273	2326
N92CSMF	1858	1913	1961	2009	2060	2117	2158	2213	2273	2326
N92CSRRCF	2381	2446	2502	2558	2617	2684	2731	2796	2866	2927
N92CSRRF	2381	2446	2502	2558	2617	2684	2731	2796	2866	2927
N92H1BF	3508	3685	3839	3993	4154	4339	4470	4647	4840	5009
N92H1BLF	3746	3923	4077	4231	4392	4577	4708	4885	5078	5247
N92H1BHF	4221	4465	4677	4889	5111	5366	5546	5790	6055	6288
N92H1BMF	4000	4211	4395	4579	4772	4993	5150	5361	5591	5794
N92H1BRF	3746	3923	4077	4231	4392	4577	4708	4885	5078	5247
N92H1LF	3097	3242	3368	3494	3627	3778	3885	4030	4187	4326

Model Number	Alliance Program TB133 Price Grades									
	K	L	M	N	O	P	Q	R	S	T
88X-ENFXCF	\$	\$	\$	\$	\$	\$	\$	\$	\$	\$
88X-GMXXF										
88X-GRXXF										
88X-MNFXCF										
88X-MNFXCJF										
88X-MRFXCF										
88X-MRFXCJF										
89X-EUEXCF	1798	1959	2056	2109	2161	2210	2262	2311	2363	2412
89X-EUFXCF	1719	1880	1977	2030	2082	2131	2183	2232	2284	2333
89X-EUFXCJF	1944	2105	2202	2255	2307	2356	2408	2457	2509	2558
89X-EWECCF	1831	1966	2047	2092	2135	2177	2220	2261	2304	2346
89X-EWECCJF	2056	2191	2272	2317	2360	2402	2445	2486	2529	2571
89X-EWEXCF	1771	1906	1987	2032	2075	2117	2160	2201	2244	2286
89X-EWEXCJF	1996	2131	2212	2257	2300	2342	2385	2426	2469	2511
89X-GWXXF	1273	1386	1453	1491	1527	1561	1597	1632	1668	1702
89X-MUEXCF	1719	1869	1959	2009	2057	2103	2151	2197	2245	2291
89X-MUFXCF	1640	1790	1880	1930	1978	2024	2072	2118	2166	2212
89X-MUFXCJF	1865	2015	2105	2155	2203	2249	2297	2343	2391	2437
89X-MWECCF	1731	1851	1923	1963	2001	2038	2077	2113	2152	2189
89X-MWECCJF	1956	2076	2148	2188	2226	2263	2302	2338	2377	2414
89X-MWEXCF	1671	1791	1863	1903	1941	1978	2017	2053	2092	2129
89X-MWEXCJF	1896	2016	2088	2128	2166	2203	2242	2278	2317	2354
N90AAF	3621	3981	4197	4317	4432	4543	4658	4768	4883	4994
N90BBF	5369	5992	6365	6573	6772	6963	7162	7353	7552	7743
N90CCF	6218	6901	7310	7538	7756	7965	8184	8393	8611	8821
N92B1F	2197	2400	2521	2589	2653	2715	2780	2842	2907	2969
N92B2F	3197	3527	3725	3835	3941	4042	4147	4249	4354	4455
N92B3F	4196	4654	4928	5081	5227	5367	5514	5654	5800	5941
N92B9F	2825	3043	3173	3246	3315	3382	3451	3518	3588	3654
N92CSACF	3281	3544	3701	3789	3873	3953	4037	4118	4202	4282
N92CSAF	3281	3544	3701	3789	3873	3953	4037	4118	4202	4282
N92CSALCF	3520	3783	3940	4028	4112	4192	4276	4357	4441	4521
N92CSALF	3520	3783	3940	4028	4112	4192	4276	4357	4441	4521
N92CSARCF	3520	3783	3940	4028	4112	4192	4276	4357	4441	4521
N92CSARF	3520	3783	3940	4028	4112	4192	4276	4357	4441	4521
N92CSLLCF	3031	3241	3367	3437	3504	3569	3636	3700	3767	3832
N92CSLLF	3031	3241	3367	3437	3504	3569	3636	3700	3767	3832
N92CSMCF	2415	2595	2703	2763	2821	2876	2933	2989	3046	3101
N92CSMF	2415	2595	2703	2763	2821	2876	2933	2989	3046	3101
N92CSRRCF	3031	3241	3367	3437	3504	3569	3636	3700	3767	3832
N92CSRRF	3031	3241	3367	3437	3504	3569	3636	3700	3767	3832
N92H1BF	5294	5872	6218	6411	6595	6772	6957	7134	7319	7496
N92H1BLF	5532	6110	6456	6649	6833	7010	7195	7372	7557	7734
N92H1BHF	6680	7475	7952	8217	8471	8715	8970	9213	9468	9712
N92H1BMF	6134	6824	7238	7468	7689	7900	8121	8333	8554	8765
N92H1BRF	5532	6110	6456	6649	6833	7010	7195	7372	7557	7734
N92H1LF	4559	5032	5315	5473	5624	5769	5920	6065	6216	6361

Alliance Program TB133 Fire Rated Pricing

Finishes

IM	Brighton	CW	Cordovan
NM	Natural	DW	Judicial
HN	Honey	MH	Mocha
CL	Caramel	405	Designer White
TF	Truffle	462	Cinder
AC	Autumn	792	Sable
MC	Amber	793	Acorn

To order, specify the following:

1. Chair Model Number
2. Fabric Grade Letter
3. Alliance Pattern Number and Color Number/Name
4. Finish Number (when applicable)

Sample Order Number

<u>N14KKF</u>	<u>A</u>	<u>403901</u>	<u>036</u>	<u>HN</u>
Model Number	Fabric Grade Letter	Alliance Pattern Number	Alliance Color Number	Finish

Model Number

Alliance Program TB133 Price Grades

	A	B	C	D	E	F	G	H	I	J
N92H1LHF	\$ 3460	\$ 3640	\$ 3796	\$ 3952	\$ 4116	\$ 4303	\$ 4435	\$ 4615	\$ 4810	\$ 4981
N92H1LLF	3336	3481	3607	3733	3866	4017	4124	4269	4426	4565
N92H1LMF	3349	3512	3654	3796	3945	4116	4236	4400	4577	4733
N92H1MF	2700	2815	2915	3015	3120	3240	3325	3440	3565	3675
N92H1RHF	3460	3640	3796	3952	4116	4303	4435	4615	4810	4981
N92H1RF	3097	3242	3368	3494	3627	3778	3885	4030	4187	4326
N92H1RMF	3349	3512	3654	3796	3945	4116	4236	4400	4577	4733
N92H1RRF	3336	3481	3607	3733	3866	4017	4124	4269	4426	4565
N92H2BBF	5694	5959	6189	6419	6660	6936	7132	7396	7684	7937
N92H2BF	5217	5482	5712	5942	6183	6459	6655	6919	7207	7460
N92H2BHF	5944	6278	6568	6858	7162	7510	7757	8090	8453	8772
N92H2BLF	5456	5721	5951	6181	6422	6698	6894	7158	7446	7699
N92H2BMF	5721	6022	6284	6546	6821	7136	7358	7660	7987	8275
N92H2BRF	5456	5721	5951	6181	6422	6698	6894	7158	7446	7699
N92H2LF	4820	5054	5258	5462	5676	5921	6095	6329	6584	6809
N92H2LHF	5183	5452	5686	5920	6165	6446	6645	6914	7207	7464
N92H2LLF	5059	5293	5497	5701	5915	6160	6334	6568	6823	7048
N92H2LMF	5072	5325	5545	5765	5996	6260	6447	6700	6975	7217
N92H2MF	4422	4627	4805	4983	5170	5383	5535	5739	5962	6158
N92H2RF	4820	5054	5258	5462	5676	5921	6095	6329	6584	6809
N92H2RHF	5183	5452	5686	5920	6165	6446	6645	6914	7207	7464
N92H2RMF	5072	5325	5545	5765	5996	6260	6447	6700	6975	7217
N92H2RRF	5059	5293	5497	5701	5915	6160	6334	6568	6823	7048
N92H3BBF	7417	7771	8079	8387	8711	9080	9342	9696	10081	10420
N92H3BF	6939	7293	7601	7909	8233	8602	8864	9218	9603	9942
N92H3BLF	7178	7532	7840	8148	8472	8841	9103	9457	9842	10181
N92H3BHF	7666	8089	8457	8825	9212	9653	9966	10389	10849	11254
N92H3BMF	7443	7834	8174	8514	8871	9279	9568	9959	10384	10758
N92H3BRF	7178	7532	7840	8148	8472	8841	9103	9457	9842	10181
N92H3LF	6541	6865	7147	7429	7725	8064	8303	8628	8980	9290
N92H3LHF	6905	7264	7576	7888	8215	8590	8855	9214	9604	9947
N92H3LLF	6780	7104	7386	7668	7964	8303	8542	8867	9219	9529
N92H3LMF	6794	7137	7435	7733	8046	8403	8657	8999	9372	9700
N92H3MF	6134	6426	6680	6934	7200	7505	7721	8013	8331	8610
N92H3RF	6541	6865	7147	7429	7725	8064	8303	8628	8980	9290
N92H3RHF	6905	7264	7576	7888	8215	8590	8855	9214	9604	9947
N92H3RMF	6794	7137	7435	7733	8046	8403	8657	8999	9372	9700
N92H3RRF	6780	7104	7386	7668	7964	8303	8542	8867	9219	9529
N92HC2F	6505	6716	6900	7084	7277	7498	7655	7866	8096	8299
N92HC3F	9320	9688	10008	10328	10664	11048	11320	11688	12088	12440
N92HIN9F	3828	3970	4094	4218	4348	4497	4603	4745	4900	5037
N92HOU9F	3681	3796	3896	3996	4101	4221	4306	4421	4546	4656
N92HSQ9DF	3504	3631	3741	3851	3966	4098	4192	4318	4456	4577
N92HSQ9LF	3455	3572	3674	3776	3883	4006	4092	4210	4337	4449
N92HSQ9RF	3455	3572	3674	3776	3883	4006	4092	4210	4337	4449
N92HTL2BBF	6891	7061	7209	7357	7513	7690	7816	7986	8171	8334
N92HTL2BF	6415	6585	6733	6881	7037	7214	7340	7510	7695	7858

Model Number	Alliance Program TB133 Price Grades									
	K	L	M	N	O	P	Q	R	S	T
N92H1LHF	\$ 5270	\$ 5855	\$ 6206	\$ 6401	\$ 6588	\$ 6768	\$ 6955	\$ 7134	\$ 7321	\$ 7501
N92H1LLF	4798	5271	5554	5712	5863	6008	6159	6304	6455	6600
N92H1LMF	4996	5529	5848	6026	6196	6359	6530	6693	6863	7027
N92H1MF	3860	4235	4460	4585	4705	4820	4940	5055	5175	5290
N92H1RHF	5270	5855	6206	6401	6588	6768	6955	7134	7321	7501
N92H1RF	4559	5032	5315	5473	5624	5769	5920	6065	6216	6361
N92H1RMF	4996	5529	5848	6026	6196	6359	6530	6693	6863	7027
N92H1RRF	4798	5271	5554	5712	5863	6008	6159	6304	6455	6600
N92H2BBF	8362	9225	9742	10030	10306	10570	10846	11111	11387	11651
N92H2BF	7885	8748	9265	9553	9829	10093	10369	10634	10910	11174
N92H2BHF	9308	10396	11048	11411	11759	12092	12440	12774	13122	13455
N92H2BLF	8124	8987	9504	9792	10068	10332	10608	10873	11149	11413
N92H2BMF	8760	9743	10332	10660	10974	11275	11590	11891	12205	12507
N92H2BRF	8124	8987	9504	9792	10068	10332	10608	10873	11149	11413
N92H2LF	7186	7951	8410	8665	8910	9144	9389	9624	9869	10103
N92H2LHF	7897	8775	9301	9594	9874	10143	10424	10693	10974	11243
N92H2LLF	7425	8190	8649	8904	9149	9383	9628	9863	10108	10342
N92H2LMF	7624	8449	8944	9219	9483	9736	10000	10253	10517	10770
N92H2MF	6487	7155	7555	7778	7991	8196	8409	8614	8828	9032
N92H2RF	7186	7951	8410	8665	8910	9144	9389	9624	9869	10103
N92H2RHF	7897	8775	9301	9594	9874	10143	10424	10693	10974	11243
N92H2RMF	7624	8449	8944	9219	9483	9736	10000	10253	10517	10770
N92H2RRF	7425	8190	8649	8904	9149	9383	9628	9863	10108	10342
N92H3BBF	10990	12145	12838	13223	13593	13947	14316	14671	15040	15394
N92H3BF	10512	11667	12360	12745	13115	13469	13838	14193	14562	14916
N92H3BLF	10751	11906	12599	12984	13354	13708	14077	14432	14801	15155
N92H3BHF	11935	13315	14143	14603	15045	15468	15909	16333	16774	17197
N92H3BMF	11387	12662	13427	13852	14260	14651	15059	15450	15858	16249
N92H3BRF	10751	11906	12599	12984	13354	13708	14077	14432	14801	15155
N92H3LF	9812	10870	11504	11857	12195	12519	12858	13182	13520	13845
N92H3LHF	10524	11694	12396	12786	13160	13519	13894	14252	14627	14986
N92H3LLF	10051	11109	11743	12096	12434	12758	13097	13421	13759	14084
N92H3LMF	10251	11369	12039	12412	12769	13112	13469	13812	14170	14512
N92H3MF	9080	10033	10604	10922	11226	11518	11823	12115	12420	12712
N92H3RF	9812	10870	11504	11857	12195	12519	12858	13182	13520	13845
N92H3RHF	10524	11694	12396	12786	13160	13519	13894	14252	14627	14986
N92H3RMF	10251	11369	12039	12412	12769	13112	13469	13812	14170	14512
N92H3RRF	10051	11109	11743	12096	12434	12758	13097	13421	13759	14084
N92HC2F	8639	9329	9743	9973	10194	10405	10626	10838	11059	11270
N92HC3F	13032	14232	14952	15352	15736	16104	16488	16856	17240	17608
N92HIN9F	5266	5731	6010	6165	6314	6456	6605	6748	6897	7039
N92HOU9F	4841	5216	5441	5566	5686	5801	5921	6036	6156	6271
N92HSQ9DF	4780	5193	5440	5578	5710	5836	5968	6095	6227	6353
N92HSQ9LF	4638	5021	5250	5378	5500	5617	5740	5857	5979	6097
N92HSQ9RF	4638	5021	5250	5378	5500	5617	5740	5857	5979	6097
N92HTL2BBF	8608	9163	9496	9681	9859	10029	10206	10377	10554	10724
N92HTL2BF	8132	8687	9020	9205	9383	9553	9730	9901	10078	10248

Alliance Program TB133 Fire Rated Pricing

Finishes

IM	Brighton	CW	Cordovan
NM	Natural	DW	Judicial
HN	Honey	MH	Mocha
CL	Caramel	405	Designer White
TF	Truffle	462	Cinder
AC	Autumn	792	Sable
MC	Amber	793	Acorn

To order, specify the following:

1. Chair Model Number
2. Fabric Grade Letter
3. Alliance Pattern Number and Color Number/Name
4. Finish Number (when applicable)

Sample Order Number

<u>N14KKF</u>	<u>A</u>	<u>403901</u>	<u>036</u>	<u>HN</u>
Model Number	Fabric Grade Letter	Alliance Pattern Number	Alliance Color Number	Finish

Model Number

Alliance Program TB133 Price Grades

	A	B	C	D	E	F	G	H	I	J
N92HTL2BHF	\$ 7372	\$ 7655	\$ 7901	\$ 8147	\$ 8406	\$ 8701	\$ 8910	\$ 9193	\$ 9500	\$ 9771
N92HTL2BLF	6653	6823	6971	7119	7275	7452	7578	7748	7933	8096
N92HTL2BMF	7151	7402	7620	7838	8067	8328	8514	8764	9037	9277
N92HTL2BRF	6653	6823	6971	7119	7275	7452	7578	7748	7933	8096
N92HTL2LF	6261	6447	6609	6771	6941	7136	7273	7460	7662	7840
N92HTL2LHF	6612	6831	7021	7211	7410	7638	7800	8018	8256	8465
N92HTL2LLF	6500	6686	6848	7010	7180	7375	7512	7699	7901	8079
N92HTL2LMF	6500	6703	6879	7055	7240	7451	7600	7803	8023	8216
N92HTL2MF	5852	6006	6140	6274	6414	6575	6689	6843	7011	7158
N92HTL2RF	6261	6447	6609	6771	6941	7136	7273	7460	7662	7840
N92HTL2RHF	6612	6831	7021	7211	7410	7638	7800	8018	8256	8465
N92HTL2RMF	6500	6703	6879	7055	7240	7451	7600	7803	8023	8216
N92HTL2RRF	6500	6686	6848	7010	7180	7375	7512	7699	7901	8079
N92HTL3BBF	9054	9337	9583	9829	10088	10383	10592	10875	11182	11453
N92HTL3BHF	9292	9641	9945	10249	10568	10933	11192	11541	11921	12256
N92HTL3BF	8576	8859	9105	9351	9610	9905	10114	10397	10704	10975
N92HTL3BLF	8815	9098	9344	9590	9849	10144	10353	10636	10943	11214
N92HTL3BMF	9057	9372	9646	9920	10207	10536	10769	11084	11427	11728
N92HTL3BRF	8815	9098	9344	9590	9849	10144	10353	10636	10943	11214
N92HTL3LF	8167	8418	8636	8854	9083	9344	9530	9780	10053	10293
N92HTL3LHF	8517	8800	9046	9292	9551	9846	10055	10338	10645	10916
N92HTL3LLF	8406	8657	8875	9093	9322	9583	9769	10019	10292	10532
N92HTL3LMF	8420	8689	8923	9157	9402	9683	9882	10151	10444	10701
N92HTL3MF	7770	7991	8183	8375	8576	8807	8970	9191	9431	9642
N92HTL3RF	8167	8418	8636	8854	9083	9344	9530	9780	10053	10293
N92HTL3RHF	8517	8800	9046	9292	9551	9846	10055	10338	10645	10916
N92HTL3RMF	8420	8689	8923	9157	9402	9683	9882	10151	10444	10701
N92HTL3RRF	8406	8657	8875	9093	9322	9583	9769	10019	10292	10532
N92HTLC2F	7652	7769	7871	7973	8080	8203	8289	8407	8534	8646
N92HTLC3F	10257	10414	10550	10686	10829	10992	11107	11264	11434	11583
N92HTLIN9F	5243	5342	5428	5514	5605	5708	5781	5880	5987	6082
N92HTLSQ9DF	4883	4959	5025	5091	5161	5240	5296	5372	5454	5527
N92HTLSQ9LF	4847	4916	4976	5036	5099	5171	5222	5291	5366	5432
N92HTLSQ9RF	4847	4916	4976	5036	5099	5171	5222	5291	5366	5432
N92HTU2BBF	6543	6808	7038	7268	7509	7785	7981	8245	8533	8786
N92HTU2BF	6066	6331	6561	6791	7032	7308	7504	7768	8056	8309
N92HTU2BHF	6792	7126	7416	7706	8010	8358	8605	8938	9301	9620
N92HTU2BLF	6305	6570	6800	7030	7271	7547	7743	8007	8295	8548
N92HTU2BMF	6570	6871	7133	7395	7670	7985	8207	8509	8836	9124
N92HTU2BRF	6305	6570	6800	7030	7271	7547	7743	8007	8295	8548
N92HTU2LF	5669	5903	6107	6311	6525	6770	6944	7178	7433	7658
N92HTU2LHF	6032	6301	6535	6769	7014	7295	7494	7763	8056	8313
N92HTU2LLF	5908	6142	6346	6550	6764	7009	7183	7417	7672	7897
N92HTU2LMF	5920	6173	6393	6613	6844	7108	7295	7548	7823	8065
N92HTU2MF	5271	5476	5654	5832	6019	6232	6384	6588	6811	7007
N92HTU2RF	5669	5903	6107	6311	6525	6770	6944	7178	7433	7658
N92HTU2RHF	6032	6301	6535	6769	7014	7295	7494	7763	8056	8313

Model Number	Alliance Program TB133 Price Grades									
	K	L	M	N	O	P	Q	R	S	T
N92HTL2BHF	\$ 10226	\$ 11149	\$ 11702	\$ 12010	\$ 12305	\$ 12588	\$ 12883	\$ 13166	\$ 13461	\$ 13744
N92HTL2BLF	8370	8925	9258	9443	9621	9791	9968	10139	10316	10486
N92HTL2BMF	9680	10498	10988	11261	11522	11773	12034	12285	12547	12797
N92HTL2BRF	8370	8925	9258	9443	9621	9791	9968	10139	10316	10486
N92HTL2LF	8140	8748	9112	9315	9509	9695	9890	10076	10270	10457
N92HTL2LHF	8816	9529	9956	10194	10422	10640	10868	11087	11315	11533
N92HTL2LLF	8379	8987	9351	9554	9748	9934	10129	10315	10509	10696
N92HTL2LMF	8542	9202	9598	9818	10029	10232	10443	10645	10856	11059
N92HTL2MF	7406	7909	8210	8378	8538	8692	8853	9007	9168	9322
N92HTL2RF	8140	8748	9112	9315	9509	9695	9890	10076	10270	10457
N92HTL2RHF	8816	9529	9956	10194	10422	10640	10868	11087	11315	11533
N92HTL2RMF	8542	9202	9598	9818	10029	10232	10443	10645	10856	11059
N92HTL2RRF	8379	8987	9351	9554	9748	9934	10129	10315	10509	10696
N92HTL3BBF	11908	12831	13384	13692	13987	14270	14565	14848	15143	15426
N92HTL3BHF	12818	13958	14642	15022	15387	15736	16101	16451	16816	17165
N92HTL3BF	11430	12353	12906	13214	13509	13792	14087	14370	14665	14948
N92HTL3BLF	11669	12592	13145	13453	13748	14031	14326	14609	14904	15187
N92HTL3BMF	12235	13263	13879	14222	14550	14865	15194	15509	15838	16153
N92HTL3BRF	11669	12592	13145	13453	13748	14031	14326	14609	14904	15187
N92HTL3LF	10696	11514	12004	12277	12538	12789	13050	13301	13563	13813
N92HTL3LHF	11371	12294	12847	13155	13450	13733	14028	14311	14606	14889
N92HTL3LLF	10935	11753	12243	12516	12777	13028	13289	13540	13802	14052
N92HTL3LMF	11134	12012	12538	12831	13111	13380	13661	13930	14211	14480
N92HTL3MF	9997	10717	11149	11389	11619	11840	12071	12291	12522	12743
N92HTL3RF	10696	11514	12004	12277	12538	12789	13050	13301	13563	13813
N92HTL3RHF	11371	12294	12847	13155	13450	13733	14028	14311	14606	14889
N92HTL3RMF	11134	12012	12538	12831	13111	13380	13661	13930	14211	14480
N92HTL3RRF	10935	11753	12243	12516	12777	13028	13289	13540	13802	14052
N92HTLC2F	8835	9218	9447	9575	9697	9814	9937	10054	10176	10294
N92HTLC3F	11835	12345	12651	12821	12984	13141	13304	13460	13623	13780
N92HTLIN9F	6241	6564	6757	6865	6968	7067	7170	7269	7372	7471
N92HTLSQ9DF	5649	5897	6045	6128	6207	6283	6362	6438	6517	6593
N92HTLSQ9LF	5543	5768	5903	5978	6050	6119	6191	6260	6332	6401
N92HTLSQ9RF	5543	5768	5903	5978	6050	6119	6191	6260	6332	6401
N92HTU2BBF	9211	10074	10591	10879	11155	11419	11695	11960	12236	12500
N92HTU2BF	8734	9597	10114	10402	10678	10942	11218	11483	11759	12023
N92HTU2BHF	10156	11244	11896	12259	12607	12940	13288	13622	13970	14303
N92HTU2BLF	8973	9836	10353	10641	10917	11181	11457	11722	11998	12262
N92HTU2BMF	9609	10592	11181	11509	11823	12124	12439	12740	13054	13356
N92HTU2BRF	8973	9836	10353	10641	10917	11181	11457	11722	11998	12262
N92HTU2LF	8035	8800	9259	9514	9759	9993	10238	10473	10718	10952
N92HTU2LHF	8746	9624	10150	10443	10723	10992	11273	11542	11823	12092
N92HTU2LLF	8274	9039	9498	9753	9998	10232	10477	10712	10957	11191
N92HTU2LMF	8472	9297	9792	10067	10331	10584	10848	11101	11365	11618
N92HTU2MF	7336	8004	8404	8627	8840	9045	9258	9463	9677	9881
N92HTU2RF	8035	8800	9259	9514	9759	9993	10238	10473	10718	10952
N92HTU2RHF	8746	9624	10150	10443	10723	10992	11273	11542	11823	12092

Alliance Program TB133 Fire Rated Pricing

Finishes

IM	Brighton	CW	Cordovan
NM	Natural	DW	Judicial
HN	Honey	MH	Mocha
CL	Caramel	405	Designer White
TF	Truffle	462	Cinder
AC	Autumn	792	Sable
MC	Amber	793	Acorn

To order, specify the following:

1. Chair Model Number
2. Fabric Grade Letter
3. Alliance Pattern Number and Color Number/Name
4. Finish Number (when applicable)

Sample Order Number

<u>N14KKF</u>	<u>A</u>	<u>403901</u>	<u>036</u>	<u>HN</u>
Model Number	Fabric Grade Letter	Alliance Pattern Number	Alliance Color Number	Finish

Model Number

Alliance Program TB133 Price Grades

	A	B	C	D	E	F	G	H	I	J
N92HTU2RMF	\$ 5920	\$ 6173	\$ 6393	\$ 6613	\$ 6844	\$ 7108	\$ 7295	\$ 7548	\$ 7823	\$ 8065
N92HTU2RRF	5908	6142	6346	6550	6764	7009	7183	7417	7672	7897
N92HTU3BBF	8160	8514	8822	9130	9454	9823	10085	10439	10824	11163
N92HTU3BF	7682	8036	8344	8652	8976	9345	9607	9961	10346	10685
N92HTU3BHF	8409	8832	9200	9568	9955	10396	10709	11132	11592	11997
N92HTU3BLF	7921	8275	8583	8891	9215	9584	9846	10200	10585	10924
N92HTU3BMF	8186	8577	8917	9257	9614	10022	10311	10702	11127	11501
N92HTU3BRF	7921	8275	8583	8891	9215	9584	9846	10200	10585	10924
N92HTU3LF	7284	7608	7890	8172	8468	8807	9046	9371	9723	10033
N92HTU3LHF	7647	8006	8318	8630	8957	9332	9597	9956	10346	10689
N92HTU3LLF	7523	7847	8129	8411	8707	9046	9285	9610	9962	10272
N92HTU3LMF	7537	7880	8178	8476	8789	9146	9400	9742	10115	10443
N92HTU3MF	6876	7168	7422	7676	7942	8247	8463	8755	9073	9352
N92HTU3RF	7284	7608	7890	8172	8468	8807	9046	9371	9723	10033
N92HTU3RHF	7647	8006	8318	8630	8957	9332	9597	9956	10346	10689
N92HTU3RMF	7537	7880	8178	8476	8789	9146	9400	9742	10115	10443
N92HTU3RRF	7523	7847	8129	8411	8707	9046	9285	9610	9962	10272
N92HTUC2F	7329	7540	7724	7908	8101	8322	8479	8690	8920	9123
N92HTUC3F	10144	10512	10832	11152	11488	11872	12144	12512	12912	13264
N92HTUIN9F	4652	4794	4918	5042	5172	5321	5427	5569	5724	5861
N92HTUSQ9DF	4328	4455	4565	4675	4790	4922	5016	5142	5280	5401
N92HTUSQ9LF	4279	4396	4498	4600	4707	4830	4916	5034	5161	5273
N92HTUSQ9RF	4279	4396	4498	4600	4707	4830	4916	5034	5161	5273
N92HTW2BBF	6891	7061	7209	7357	7513	7690	7816	7986	8171	8334
N92HTW2BF	6415	6585	6733	6881	7037	7214	7340	7510	7695	7858
N92HTW2BHF	7372	7655	7901	8147	8406	8701	8910	9193	9500	9771
N92HTW2BLF	6653	6823	6971	7119	7275	7452	7578	7748	7933	8096
N92HTW2BMF	7151	7402	7620	7838	8067	8328	8514	8764	9037	9277
N92HTW2BRF	6653	6823	6971	7119	7275	7452	7578	7748	7933	8096
N92HTW2LF	6261	6447	6609	6771	6941	7136	7273	7460	7662	7840
N92HTW2LHF	6612	6831	7021	7211	7410	7638	7800	8018	8256	8465
N92HTW2LLF	6500	6686	6848	7010	7180	7375	7512	7699	7901	8079
N92HTW2LMF	6500	6703	6879	7055	7240	7451	7600	7803	8023	8216
N92HTW2MF	5852	6006	6140	6274	6414	6575	6689	6843	7011	7158
N92HTW2RF	6261	6447	6609	6771	6941	7136	7273	7460	7662	7840
N92HTW2RHF	6612	6831	7021	7211	7410	7638	7800	8018	8256	8465
N92HTW2RMF	6500	6703	6879	7055	7240	7451	7600	7803	8023	8216
N92HTW2RRF	6500	6686	6848	7010	7180	7375	7512	7699	7901	8079
N92HTW3BBF	9054	9337	9583	9829	10088	10383	10592	10875	11182	11453
N92HTW3BHF	9292	9641	9945	10249	10568	10933	11192	11541	11921	12256
N92HTW3BF	8576	8859	9105	9351	9610	9905	10114	10397	10704	10975
N92HTW3BLF	8815	9098	9344	9590	9849	10144	10353	10636	10943	11214
N92HTW3BMF	9057	9372	9646	9920	10207	10536	10769	11084	11427	11728
N92HTW3BRF	8815	9098	9344	9590	9849	10144	10353	10636	10943	11214
N92HTW3LF	8167	8418	8636	8854	9083	9344	9530	9780	10053	10293
N92HTW3LHF	8517	8800	9046	9292	9551	9846	10055	10338	10645	10916
N92HTW3LLF	8406	8657	8875	9093	9322	9583	9769	10019	10292	10532

Model Number	Alliance Program TB133 Price Grades									
	K	L	M	N	O	P	Q	R	S	T
N92HTU2RMF	\$ 8472	\$ 9297	\$ 9792	\$ 10067	\$ 10331	\$ 10584	\$ 10848	\$ 11101	\$ 11365	\$ 11618
N92HTU2RRF	8274	9039	9498	9753	9998	10232	10477	10712	10957	11191
N92HTU3BBF	11733	12888	13581	13966	14336	14690	15059	15414	15783	16137
N92HTU3BF	11255	12410	13103	13488	13858	14212	14581	14936	15305	15659
N92HTU3BHF	12678	14058	14886	15346	15788	16211	16652	17076	17517	17940
N92HTU3BLF	11494	12649	13342	13727	14097	14451	14820	15175	15544	15898
N92HTU3BMF	12130	13405	14170	14595	15003	15394	15802	16193	16601	16992
N92HTU3BRF	11494	12649	13342	13727	14097	14451	14820	15175	15544	15898
N92HTU3LF	10555	11613	12247	12600	12938	13262	13601	13925	14263	14588
N92HTU3LHF	11266	12436	13138	13528	13902	14261	14636	14994	15369	15728
N92HTU3LLF	10794	11852	12486	12839	13177	13501	13840	14164	14502	14827
N92HTU3LMF	10994	12112	12782	13155	13512	13855	14212	14555	14913	15255
N92HTU3MF	9822	10775	11346	11664	11968	12260	12565	12857	13162	13454
N92HTU3RF	10555	11613	12247	12600	12938	13262	13601	13925	14263	14588
N92HTU3RHF	11266	12436	13138	13528	13902	14261	14636	14994	15369	15728
N92HTU3RMF	10994	12112	12782	13155	13512	13855	14212	14555	14913	15255
N92HTU3RRF	10794	11852	12486	12839	13177	13501	13840	14164	14502	14827
N92HTUC2F	9463	10153	10567	10797	11018	11229	11450	11662	11883	12094
N92HTUC3F	13856	15056	15776	16176	16560	16928	17312	17680	18064	18432
N92HTUIN9F	6090	6555	6834	6989	7138	7280	7429	7572	7721	7863
N92HTUSQ9DF	5604	6017	6264	6402	6534	6660	6792	6919	7051	7177
N92HTUSQ9LF	5462	5845	6074	6202	6324	6441	6564	6681	6803	6921
N92HTUSQ9RF	5462	5845	6074	6202	6324	6441	6564	6681	6803	6921
N92HTW2BBF	8608	9163	9496	9681	9859	10029	10206	10377	10554	10724
N92HTW2BF	8132	8687	9020	9205	9383	9553	9730	9901	10078	10248
N92HTW2BHF	10226	11149	11702	12010	12305	12588	12883	13166	13461	13744
N92HTW2BLF	8370	8925	9258	9443	9621	9791	9968	10139	10316	10486
N92HTW2BMF	9680	10498	10988	11261	11522	11773	12034	12285	12547	12797
N92HTW2BRF	8370	8925	9258	9443	9621	9791	9968	10139	10316	10486
N92HTW2LF	8140	8748	9112	9315	9509	9695	9890	10076	10270	10457
N92HTW2LHF	8816	9529	9956	10194	10422	10640	10868	11087	11315	11533
N92HTW2LLF	8379	8987	9351	9554	9748	9934	10129	10315	10509	10696
N92HTW2LMF	8542	9202	9598	9818	10029	10232	10443	10645	10856	11059
N92HTW2MF	7406	7909	8210	8378	8538	8692	8853	9007	9168	9322
N92HTW2RF	8140	8748	9112	9315	9509	9695	9890	10076	10270	10457
N92HTW2RHF	8816	9529	9956	10194	10422	10640	10868	11087	11315	11533
N92HTW2RMF	8542	9202	9598	9818	10029	10232	10443	10645	10856	11059
N92HTW2RRF	8379	8987	9351	9554	9748	9934	10129	10315	10509	10696
N92HTW3BBF	11908	12831	13384	13692	13987	14270	14565	14848	15143	15426
N92HTW3BHF	12818	13958	14642	15022	15387	15736	16101	16451	16816	17165
N92HTW3BF	11430	12353	12906	13214	13509	13792	14087	14370	14665	14948
N92HTW3BLF	11669	12592	13145	13453	13748	14031	14326	14609	14904	15187
N92HTW3BMF	12235	13263	13879	14222	14550	14865	15194	15509	15838	16153
N92HTW3BRF	11669	12592	13145	13453	13748	14031	14326	14609	14904	15187
N92HTW3LF	10696	11514	12004	12277	12538	12789	13050	13301	13563	13813
N92HTW3LHF	11371	12294	12847	13155	13450	13733	14028	14311	14606	14889
N92HTW3LLF	10935	11753	12243	12516	12777	13028	13289	13540	13802	14052

Alliance Program TB133 Fire Rated Pricing

Finishes

IM	Brighton	CW	Cordovan
NM	Natural	DW	Judicial
HN	Honey	MH	Mocha
CL	Caramel	405	Designer White
TF	Truffle	462	Cinder
AC	Autumn	792	Sable
MC	Amber	793	Acorn

To order, specify the following:

1. Chair Model Number
2. Fabric Grade Letter
3. Alliance Pattern Number and Color Number/Name
4. Finish Number (when applicable)

Sample Order Number

<u>N14KKF</u>	<u>A</u>	<u>403901</u>	<u>036</u>	<u>HN</u>
Model Number	Fabric Grade Letter	Alliance Pattern Number	Alliance Color Number	Finish

Model Number

Alliance Program TB133 Price Grades

	A	B	C	D	E	F	G	H	I	J
N92HTW3LMF	\$ 8420	\$ 8689	\$ 8923	\$ 9157	\$ 9402	\$ 9683	\$ 9882	\$ 10151	\$ 10444	\$ 10701
N92HTW3MF	7770	7991	8183	8375	8576	8807	8970	9191	9431	9642
N92HTW3RF	8167	8418	8636	8854	9083	9344	9530	9780	10053	10293
N92HTW3RHF	8517	8800	9046	9292	9551	9846	10055	10338	10645	10916
N92HTW3RMF	8420	8689	8923	9157	9402	9683	9882	10151	10444	10701
N92HTW3RRF	8406	8657	8875	9093	9322	9583	9769	10019	10292	10532
N92HTWC2F	7652	7769	7871	7973	8080	8203	8289	8407	8534	8646
N92HTWC3F	10257	10414	10550	10686	10829	10992	11107	11264	11434	11583
N92HTWIN9F	5243	5342	5428	5514	5605	5708	5781	5880	5987	6082
N92HTWSQ9DF	4883	4959	5025	5091	5161	5240	5296	5372	5454	5527
N92HTWSQ9LF	4847	4916	4976	5036	5099	5171	5222	5291	5366	5432
N92HTWSQ9RF	4847	4916	4976	5036	5099	5171	5222	5291	5366	5432
N92M1BF	2866	3023	3159	3295	3438	3601	3716	3873	4043	4192
N92M1BLF	3104	3261	3397	3533	3676	3839	3954	4111	4281	4430
N92M1BMF	3358	3549	3715	3881	4056	4255	4396	4587	4794	4977
N92M1BRF	3104	3261	3397	3533	3676	3839	3954	4111	4281	4430
N92M1LF	2469	2596	2706	2816	2931	3063	3157	3283	3421	3542
N92M1LLF	2708	2835	2945	3055	3170	3302	3396	3522	3660	3781
N92M1LMF	2710	2852	2976	3100	3230	3379	3485	3627	3782	3919
N92M1MF	2059	2153	2235	2317	2403	2502	2571	2666	2768	2858
N92M1RF	2469	2596	2706	2816	2931	3063	3157	3283	3421	3542
N92M1RMF	2710	2852	2976	3100	3230	3379	3485	3627	3782	3919
N92M1RRF	2708	2835	2945	3055	3170	3302	3396	3522	3660	3781
N92M2BBF	4425	4651	4847	5043	5249	5484	5650	5876	6121	6336
N92M2BF	3948	4174	4370	4566	4772	5007	5173	5399	5644	5859
N92M2BLF	4187	4413	4609	4805	5011	5246	5412	5638	5883	6098
N92M2BMF	4440	4700	4926	5152	5390	5661	5853	6113	6395	6644
N92M2BRF	4187	4413	4609	4805	5011	5246	5412	5638	5883	6098
N92M2LF	3539	3732	3900	4068	4245	4446	4589	4782	4992	5177
N92M2LLF	3778	3971	4139	4307	4484	4685	4828	5021	5231	5416
N92M2LMF	3792	4003	4187	4371	4564	4785	4942	5153	5383	5586
N92M2MF	3141	3304	3446	3588	3737	3908	4028	4192	4369	4525
N92M2RF	3539	3732	3900	4068	4245	4446	4589	4782	4992	5177
N92M2RMF	3792	4003	4187	4371	4564	4785	4942	5153	5383	5586
N92M2RRF	3778	3971	4139	4307	4484	4685	4828	5021	5231	5416
N92M3BBF	5508	5803	6059	6315	6584	6891	7108	7403	7723	8004
N92M3BF	5030	5325	5581	5837	6106	6413	6630	6925	7245	7526
N92M3BLF	5269	5564	5820	6076	6345	6652	6869	7164	7484	7765
N92M3BMF	5522	5851	6137	6423	6724	7067	7310	7639	7996	8311
N92M3BRF	5269	5564	5820	6076	6345	6652	6869	7164	7484	7765
N92M3LF	4633	4898	5128	5358	5599	5875	6071	6335	6623	6876
N92M3LLF	4872	5137	5367	5597	5838	6114	6310	6574	6862	7115
N92M3LMF	4874	5154	5398	5642	5898	6191	6399	6679	6984	7253
N92M3MF	4224	4456	4658	4860	5072	5315	5486	5719	5971	6193
N92M3RF	4633	4898	5128	5358	5599	5875	6071	6335	6623	6876
N92M3RMF	4874	5154	5398	5642	5898	6191	6399	6679	6984	7253
N92M3RRF	4872	5137	5367	5597	5838	6114	6310	6574	6862	7115

Model Number	Alliance Program TB133 Price Grades									
	K	L	M	N	O	P	Q	R	S	T
N92HTW3LMF	\$ 11134	\$ 12012	\$ 12538	\$ 12831	\$ 13111	\$ 13380	\$ 13661	\$ 13930	\$ 14211	\$ 14480
N92HTW3MF	9997	10717	11149	11389	11619	11840	12071	12291	12522	12743
N92HTW3RF	10696	11514	12004	12277	12538	12789	13050	13301	13563	13813
N92HTW3RHF	11371	12294	12847	13155	13450	13733	14028	14311	14606	14889
N92HTW3RMF	11134	12012	12538	12831	13111	13380	13661	13930	14211	14480
N92HTW3RRF	10935	11753	12243	12516	12777	13028	13289	13540	13802	14052
N92HTWC2F	8835	9218	9447	9575	9697	9814	9937	10054	10176	10294
N92HTWC3F	11835	12345	12651	12821	12984	13141	13304	13460	13623	13780
N92HTWIN9F	6241	6564	6757	6865	6968	7067	7170	7269	7372	7471
N92HTWSQ9DF	5649	5897	6045	6128	6207	6283	6362	6438	6517	6593
N92HTWSQ9LF	5543	5768	5903	5978	6050	6119	6191	6260	6332	6401
N92HTWSQ9RF	5543	5768	5903	5978	6050	6119	6191	6260	6332	6401
N92M1BF	4444	4954	5260	5430	5593	5750	5913	6069	6232	6389
N92M1BLF	4682	5192	5498	5668	5831	5988	6151	6307	6470	6627
N92M1BMF	5284	5907	6280	6488	6687	6878	7077	7268	7467	7658
N92M1BRF	4682	5192	5498	5668	5831	5988	6151	6307	6470	6627
N92M1LF	3745	4158	4405	4543	4675	4801	4933	5060	5192	5318
N92M1LLF	3984	4397	4644	4782	4914	5040	5172	5299	5431	5557
N92M1LMF	4148	4613	4892	5047	5196	5338	5487	5630	5779	5921
N92M1MF	3010	3318	3502	3605	3703	3797	3896	3990	4088	4183
N92M1RF	3745	4158	4405	4543	4675	4801	4933	5060	5192	5318
N92M1RMF	4148	4613	4892	5047	5196	5338	5487	5630	5779	5921
N92M1RRF	3984	4397	4644	4782	4914	5040	5172	5299	5431	5557
N92M2BBF	6699	7434	7875	8120	8355	8581	8816	9041	9276	9502
N92M2BF	6222	6957	7398	7643	7878	8104	8339	8564	8799	9025
N92M2BLF	6461	7196	7637	7882	8117	8343	8578	8803	9038	9264
N92M2BMF	7062	7910	8418	8701	8972	9232	9503	9763	10034	10294
N92M2BRF	6461	7196	7637	7882	8117	8343	8578	8803	9038	9264
N92M2LF	5488	6118	6496	6706	6908	7101	7302	7496	7697	7890
N92M2LLF	5727	6357	6735	6945	7147	7340	7541	7735	7936	8129
N92M2LMF	5926	6616	7030	7260	7481	7692	7913	8125	8346	8557
N92M2MF	4788	5321	5640	5818	5988	6151	6322	6485	6655	6819
N92M2RF	5488	6118	6496	6706	6908	7101	7302	7496	7697	7890
N92M2RMF	5926	6616	7030	7260	7481	7692	7913	8125	8346	8557
N92M2RRF	5727	6357	6735	6945	7147	7340	7541	7735	7936	8129
N92M3BBF	8478	9438	10014	10334	10641	10936	11243	11537	11844	12139
N92M3BF	8000	8960	9536	9856	10163	10458	10765	11059	11366	11661
N92M3BLF	8239	9199	9775	10095	10402	10697	11004	11298	11605	11900
N92M3BMF	8840	9913	10556	10914	11257	11586	11929	12258	12601	12930
N92M3BRF	8239	9199	9775	10095	10402	10697	11004	11298	11605	11900
N92M3LF	7301	8164	8681	8969	9245	9509	9785	10050	10326	10590
N92M3LLF	7540	8403	8920	9208	9484	9748	10024	10289	10565	10829
N92M3LMF	7704	8619	9168	9473	9766	10046	10339	10620	10913	11193
N92M3MF	6567	7325	7779	8032	8274	8506	8749	8981	9223	9456
N92M3RF	7301	8164	8681	8969	9245	9509	9785	10050	10326	10590
N92M3RMF	7704	8619	9168	9473	9766	10046	10339	10620	10913	11193
N92M3RRF	7540	8403	8920	9208	9484	9748	10024	10289	10565	10829

Alliance Program TB133 Fire Rated Pricing

Finishes

IM	Brighton	CW	Cordovan
NM	Natural	DW	Judicial
HN	Honey	MH	Mocha
CL	Caramel	405	Designer White
TF	Truffle	462	Cinder
AC	Autumn	792	Sable
MC	Amber	793	Acorn

To order, specify the following:

1. Chair Model Number
2. Fabric Grade Letter
3. Alliance Pattern Number and Color Number/Name
4. Finish Number (when applicable)

Sample Order Number

<u>N14KKF</u>	<u>A</u>	<u>403901</u>	<u>036</u>	<u>HN</u>
Model Number	Fabric Grade Letter	Alliance Pattern Number	Alliance Color Number	Finish

Model Number

Alliance Program TB133 Price Grades

	A	B	C	D	E	F	G	H	I	J
N92MC2F	\$ 4675	\$ 4827	\$ 4959	\$ 5091	\$ 5229	\$ 5388	\$ 5500	\$ 5652	\$ 5817	\$ 5962
N92MC3F	6780	7049	7283	7517	7762	8043	8242	8511	8804	9061
N92MIN9F	2897	3014	3116	3218	3325	3448	3534	3652	3779	3891
N92MOU9F	2788	2884	2968	3052	3140	3241	3313	3409	3514	3607
N92MSQ9DF	2561	2660	2746	2832	2923	3026	3099	3198	3305	3400
N92MSQ9LF	2500	2588	2664	2740	2820	2911	2975	3063	3158	3241
N92MSQ9RF	2500	2588	2664	2740	2820	2911	2975	3063	3158	3241
N92MTL2BBF	5855	6030	6182	6334	6493	6676	6805	6980	7170	7337
N92MTL2BF	5378	5553	5705	5857	6016	6199	6328	6503	6693	6860
N92MTL2BLF	5617	5792	5944	6096	6255	6438	6567	6742	6932	7099
N92MTL2BMF	5870	6079	6261	6443	6634	6853	7007	7217	7444	7644
N92MTL2BRF	5617	5792	5944	6096	6255	6438	6567	6742	6932	7099
N92MTL2LF	4980	5125	5251	5377	5510	5661	5768	5913	6070	6209
N92MTL2LLF	5219	5364	5490	5616	5749	5900	6007	6152	6309	6448
N92MTL2LMF	5220	5381	5521	5661	5808	5976	6095	6256	6431	6585
N92MTL2MF	4583	4698	4798	4898	5003	5123	5208	5323	5448	5558
N92MTL2RF	4980	5125	5251	5377	5510	5661	5768	5913	6070	6209
N92MTL2RMF	5220	5381	5521	5661	5808	5976	6095	6256	6431	6585
N92MTL2RRF	5219	5364	5490	5616	5749	5900	6007	6152	6309	6448
N92MTL3BBF	7664	7885	8077	8269	8470	8701	8864	9085	9325	9536
N92MTL3BF	7186	7407	7599	7791	7992	8223	8386	8607	8847	9058
N92MTL3BLF	7425	7646	7838	8030	8231	8462	8625	8846	9086	9297
N92MTL3BMF	7678	7933	8155	8377	8610	8877	9065	9321	9598	9842
N92MTL3BRF	7425	7646	7838	8030	8231	8462	8625	8846	9086	9297
N92MTL3LF	6788	6979	7145	7311	7486	7685	7826	8017	8224	8407
N92MTL3LMF	7029	7236	7416	7596	7785	8001	8154	8361	8586	8784
N92MTL3LLF	7027	7218	7384	7550	7725	7924	8065	8256	8463	8646
N92MTL3MF	6380	6539	6677	6815	6960	7125	7243	7401	7574	7726
N92MTL3RF	6788	6979	7145	7311	7486	7685	7826	8017	8224	8407
N92MTL3RMF	7029	7236	7416	7596	7785	8001	8154	8361	8586	8784
N92MTL3RRF	7027	7218	7384	7550	7725	7924	8065	8256	8463	8646
N92MTLC2F	5909	5982	6046	6110	6177	6254	6309	6382	6462	6533
N92MTLC3F	7936	8035	8121	8207	8298	8401	8474	8573	8680	8775
N92MTLIN9F	3889	3960	4022	4084	4149	4224	4276	4348	4425	4493
N92MTLSQ9DF	3965	4018	4064	4110	4159	4214	4253	4306	4363	4414
N92MTLSQ9LF	3941	3989	4031	4073	4117	4168	4203	4252	4304	4350
N92MTLSQ9RF	3941	3989	4031	4073	4117	4168	4203	4252	4304	4350
N92MTU2BBF	5274	5500	5696	5892	6098	6333	6499	6725	6970	7185
N92MTU2BF	4797	5023	5219	5415	5621	5856	6022	6248	6493	6708
N92MTU2BLF	5036	5262	5458	5654	5860	6095	6261	6487	6732	6947
N92MTU2BMF	5289	5549	5775	6001	6239	6510	6702	6962	7244	7493
N92MTU2BRF	5036	5262	5458	5654	5860	6095	6261	6487	6732	6947
N92MTU2LF	4388	4581	4749	4917	5094	5295	5438	5631	5841	6026
N92MTU2LLF	4627	4820	4988	5156	5333	5534	5677	5870	6080	6265
N92MTU2LMF	4640	4851	5035	5219	5412	5633	5790	6001	6231	6434
N92MTU2MF	3990	4153	4295	4437	4586	4757	4877	5041	5218	5374
N92MTU2RF	4388	4581	4749	4917	5094	5295	5438	5631	5841	6026

Model Number	Alliance Program TB133 Price Grades									
	K	L	M	N	O	P	Q	R	S	T
N92MC2F	\$ 6206	\$ 6701	\$ 6998	\$ 7163	\$ 7321	\$ 7473	\$ 7632	\$ 7783	\$ 7942	\$ 8094
N92MC3F	9494	10372	10898	11191	11471	11740	12021	12290	12571	12840
N92MIN9F	4080	4463	4692	4820	4942	5059	5182	5299	5421	5539
N92MOU9F	3762	4077	4266	4371	4472	4568	4669	4766	4867	4963
N92MSQ9DF	3559	3882	4075	4183	4286	4385	4488	4587	4690	4789
N92MSQ9LF	3382	3667	3838	3933	4024	4112	4203	4290	4381	4469
N92MSQ9RF	3382	3667	3838	3933	4024	4112	4203	4290	4381	4469
N92MTL2BBF	7618	8188	8530	8720	8902	9077	9260	9434	9617	9792
N92MTL2BF	7141	7711	8053	8243	8425	8600	8783	8957	9140	9315
N92MTL2BLF	7380	7950	8292	8482	8664	8839	9022	9196	9379	9554
N92MTL2BMF	7981	8664	9073	9301	9519	9728	9947	10156	10374	10584
N92MTL2BRF	7380	7950	8292	8482	8664	8839	9022	9196	9379	9554
N92MTL2LF	6442	6915	7198	7356	7507	7652	7803	7948	8099	8244
N92MTL2LLF	6681	7154	7437	7595	7746	7891	8042	8187	8338	8483
N92MTL2LMF	6844	7369	7684	7859	8027	8188	8356	8517	8685	8846
N92MTL2MF	5743	6118	6343	6468	6588	6703	6823	6938	7058	7173
N92MTL2RF	6442	6915	7198	7356	7507	7652	7803	7948	8099	8244
N92MTL2RMF	6844	7369	7684	7859	8027	8188	8356	8517	8685	8846
N92MTL2RRF	6681	7154	7437	7595	7746	7891	8042	8187	8338	8483
N92MTL3BBF	9891	10611	11043	11283	11513	11734	11965	12185	12416	12637
N92MTL3BF	9413	10133	10565	10805	11035	11256	11487	11707	11938	12159
N92MTL3BLF	9652	10372	10804	11044	11274	11495	11726	11946	12177	12398
N92MTL3BMF	10253	11086	11585	11863	12129	12384	12651	12906	13172	13428
N92MTL3BRF	9652	10372	10804	11044	11274	11495	11726	11946	12177	12398
N92MTL3LF	8714	9337	9710	9918	10117	10308	10507	10698	10897	11088
N92MTL3LMF	9117	9792	10197	10422	10638	10845	11061	11268	11484	11691
N92MTL3LLF	8953	9576	9949	10157	10356	10547	10746	10937	11136	11327
N92MTL3MF	7981	8499	8809	8982	9147	9306	9471	9630	9796	9954
N92MTL3RF	8714	9337	9710	9918	10117	10308	10507	10698	10897	11088
N92MTL3RMF	9117	9792	10197	10422	10638	10845	11061	11268	11484	11691
N92MTL3RRF	8953	9576	9949	10157	10356	10547	10746	10937	11136	11327
N92MTLC2F	6651	6891	7035	7115	7192	7265	7342	7416	7493	7566
N92MTLC3F	8934	9257	9450	9558	9661	9760	9863	9962	10065	10164
N92MTLIN9F	4608	4841	4980	5058	5132	5203	5278	5349	5423	5495
N92MTLSQ9DF	4499	4672	4775	4833	4888	4941	4996	5049	5104	5157
N92MTLSQ9LF	4428	4586	4680	4733	4783	4831	4882	4930	4980	5029
N92MTLSQ9RF	4428	4586	4680	4733	4783	4831	4882	4930	4980	5029
N92MTU2BBF	7548	8283	8724	8969	9204	9430	9665	9890	10125	10351
N92MTU2BF	7071	7806	8247	8492	8727	8953	9188	9413	9648	9874
N92MTU2BLF	7310	8045	8486	8731	8966	9192	9427	9652	9887	10113
N92MTU2BMF	7911	8759	9267	9550	9821	10081	10352	10612	10883	11143
N92MTU2BRF	7310	8045	8486	8731	8966	9192	9427	9652	9887	10113
N92MTU2LF	6337	6967	7345	7555	7757	7950	8151	8345	8546	8739
N92MTU2LLF	6576	7206	7584	7794	7996	8189	8390	8584	8785	8978
N92MTU2LMF	6774	7464	7878	8108	8329	8540	8761	8973	9194	9405
N92MTU2MF	5637	6170	6489	6667	6837	7000	7171	7334	7504	7668
N92MTU2RF	6337	6967	7345	7555	7757	7950	8151	8345	8546	8739

Alliance Program TB133 Fire Rated Pricing

Finishes

IM	Brighton	CW	Cordovan
NM	Natural	DW	Judicial
HN	Honey	MH	Mocha
CL	Caramel	405	Designer White
TF	Truffle	462	Cinder
AC	Autumn	792	Sable
MC	Amber	793	Acorn

To order, specify the following:

1. Chair Model Number
2. Fabric Grade Letter
3. Alliance Pattern Number and Color Number/Name
4. Finish Number (when applicable)

Sample Order Number

<u>N14KKF</u>	<u>A</u>	<u>403901</u>	<u>036</u>	<u>HN</u>
Model Number	Fabric Grade Letter	Alliance Pattern Number	Alliance Color Number	Finish

Model Number

Alliance Program TB133 Price Grades

	A	B	C	D	E	F	G	H	I	J
N92MTU2RMF	\$ 4640	\$ 4851	\$ 5035	\$ 5219	\$ 5412	\$ 5633	\$ 5790	\$ 6001	\$ 6231	\$ 6434
N92MTU2RRF	4627	4820	4988	5156	5333	5534	5677	5870	6080	6265
N92MTU3BBF	6781	7076	7332	7588	7857	8164	8381	8676	8996	9277
N92MTU3BF	6303	6598	6854	7110	7379	7686	7903	8198	8518	8799
N92MTU3BLF	6542	6837	7093	7349	7618	7925	8142	8437	8757	9038
N92MTU3BMF	6795	7124	7410	7696	7997	8340	8583	8912	9269	9584
N92MTU3BRF	6542	6837	7093	7349	7618	7925	8142	8437	8757	9038
N92MTU3LF	5906	6171	6401	6631	6872	7148	7344	7608	7896	8149
N92MTU3LLF	6145	6410	6640	6870	7111	7387	7583	7847	8135	8388
N92MTU3LMF	6147	6427	6671	6915	7171	7464	7672	7952	8257	8526
N92MTU3MF	5497	5729	5931	6133	6345	6588	6759	6992	7244	7466
N92MTU3RF	5906	6171	6401	6631	6872	7148	7344	7608	7896	8149
N92MTU3RMF	6147	6427	6671	6915	7171	7464	7672	7952	8257	8526
N92MTU3RRF	6145	6410	6640	6870	7111	7387	7583	7847	8135	8388
N92MTUC2F	5499	5651	5783	5915	6053	6212	6324	6476	6641	6786
N92MTUC3F	7604	7873	8107	8341	8586	8867	9066	9335	9628	9885
N92MTUIN9F	3721	3838	3940	4042	4149	4272	4358	4476	4603	4715
N92MTUSQ9DF	3385	3484	3570	3656	3747	3850	3923	4022	4129	4224
N92MTUSQ9LF	3324	3412	3488	3564	3644	3735	3799	3887	3982	4065
N92MTUSQ9RF	3324	3412	3488	3564	3644	3735	3799	3887	3982	4065
N92MTW2BBF	5855	6030	6182	6334	6493	6676	6805	6980	7170	7337
N92MTW2BF	5378	5553	5705	5857	6016	6199	6328	6503	6693	6860
N92MTW2BLF	5617	5792	5944	6096	6255	6438	6567	6742	6932	7099
N92MTW2BMF	5870	6079	6261	6443	6634	6853	7007	7217	7444	7644
N92MTW2BRF	5617	5792	5944	6096	6255	6438	6567	6742	6932	7099
N92MTW2LF	4980	5125	5251	5377	5510	5661	5768	5913	6070	6209
N92MTW2LLF	5219	5364	5490	5616	5749	5900	6007	6152	6309	6448
N92MTW2LMF	5220	5381	5521	5661	5808	5976	6095	6256	6431	6585
N92MTW2MF	4583	4698	4798	4898	5003	5123	5208	5323	5448	5558
N92MTW2RF	4980	5125	5251	5377	5510	5661	5768	5913	6070	6209
N92MTW2RMF	5220	5381	5521	5661	5808	5976	6095	6256	6431	6585
N92MTW2RRF	5219	5364	5490	5616	5749	5900	6007	6152	6309	6448
N92MTW3BBF	7664	7885	8077	8269	8470	8701	8864	9085	9325	9536
N92MTW3BF	7186	7407	7599	7791	7992	8223	8386	8607	8847	9058
N92MTW3BLF	7425	7646	7838	8030	8231	8462	8625	8846	9086	9297
N92MTW3BMF	7678	7933	8155	8377	8610	8877	9065	9321	9598	9842
N92MTW3BRF	7425	7646	7838	8030	8231	8462	8625	8846	9086	9297
N92MTW3LF	6788	6979	7145	7311	7486	7685	7826	8017	8224	8407
N92MTW3LLF	7027	7218	7384	7550	7725	7924	8065	8256	8463	8646
N92MTW3LMF	7029	7236	7416	7596	7785	8001	8154	8361	8586	8784
N92MTW3MF	6380	6539	6677	6815	6960	7125	7243	7401	7574	7726
N92MTW3RF	6788	6979	7145	7311	7486	7685	7826	8017	8224	8407
N92MTW3RMF	7029	7236	7416	7596	7785	8001	8154	8361	8586	8784
N92MTW3RRF	7027	7218	7384	7550	7725	7924	8065	8256	8463	8646
N92MTWC2F	5909	5982	6046	6110	6177	6254	6309	6382	6462	6533
N92MTWC3F	7936	8035	8121	8207	8298	8401	8474	8573	8680	8775
N92MTWIN9F	3889	3960	4022	4084	4149	4224	4276	4348	4425	4493

Alliance Program TB133 Fire Rated Pricing

Model Number	Alliance Program TB133 Price Grades									
	K	L	M	N	O	P	Q	R	S	T
N92MTU2RMF	\$ 6774	\$ 7464	\$ 7878	\$ 8108	\$ 8329	\$ 8540	\$ 8761	\$ 8973	\$ 9194	\$ 9405
N92MTU2RRF	6576	7206	7584	7794	7996	8189	8390	8584	8785	8978
N92MTU3BBF	9751	10711	11287	11607	11914	12209	12516	12810	13117	13412
N92MTU3BF	9273	10233	10809	11129	11436	11731	12038	12332	12639	12934
N92MTU3BLF	9512	10472	11048	11368	11675	11970	12277	12571	12878	13173
N92MTU3BMF	10113	11186	11829	12187	12530	12859	13202	13531	13874	14203
N92MTU3BRF	9512	10472	11048	11368	11675	11970	12277	12571	12878	13173
N92MTU3LF	8574	9437	9954	10242	10518	10782	11058	11323	11599	11863
N92MTU3LLF	8813	9676	10193	10481	10757	11021	11297	11562	11838	12102
N92MTU3LMF	8977	9892	10441	10746	11039	11319	11612	11893	12186	12466
N92MTU3MF	7840	8598	9052	9305	9547	9779	10022	10254	10496	10729
N92MTU3RF	8574	9437	9954	10242	10518	10782	11058	11323	11599	11863
N92MTU3RMF	8977	9892	10441	10746	11039	11319	11612	11893	12186	12466
N92MTU3RRF	8813	9676	10193	10481	10757	11021	11297	11562	11838	12102
N92MTUC2F	7030	7525	7822	7987	8145	8297	8456	8607	8766	8918
N92MTUC3F	10318	11196	11722	12015	12295	12564	12845	13114	13395	13664
N92MTUIN9F	4904	5287	5516	5644	5766	5883	6006	6123	6245	6363
N92MTUSQ9DF	4383	4706	4899	5007	5110	5209	5312	5411	5514	5613
N92MTUSQ9LF	4206	4491	4662	4757	4848	4936	5027	5114	5205	5293
N92MTUSQ9RF	4206	4491	4662	4757	4848	4936	5027	5114	5205	5293
N92MTW2BBF	7618	8188	8530	8720	8902	9077	9260	9434	9617	9792
N92MTW2BF	7141	7711	8053	8243	8425	8600	8783	8957	9140	9315
N92MTW2BLF	7380	7950	8292	8482	8664	8839	9022	9196	9379	9554
N92MTW2BMF	7981	8664	9073	9301	9519	9728	9947	10156	10374	10584
N92MTW2BRF	7380	7950	8292	8482	8664	8839	9022	9196	9379	9554
N92MTW2LF	6442	6915	7198	7356	7507	7652	7803	7948	8099	8244
N92MTW2LLF	6681	7154	7437	7595	7746	7891	8042	8187	8338	8483
N92MTW2LMF	6844	7369	7684	7859	8027	8188	8356	8517	8685	8846
N92MTW2MF	5743	6118	6343	6468	6588	6703	6823	6938	7058	7173
N92MTW2RF	6442	6915	7198	7356	7507	7652	7803	7948	8099	8244
N92MTW2RMF	6844	7369	7684	7859	8027	8188	8356	8517	8685	8846
N92MTW2RRF	6681	7154	7437	7595	7746	7891	8042	8187	8338	8483
N92MTW3BBF	9891	10611	11043	11283	11513	11734	11965	12185	12416	12637
N92MTW3BF	9413	10133	10565	10805	11035	11256	11487	11707	11938	12159
N92MTW3BLF	9652	10372	10804	11044	11274	11495	11726	11946	12177	12398
N92MTW3BMF	10253	11086	11585	11863	12129	12384	12651	12906	13172	13428
N92MTW3BRF	9652	10372	10804	11044	11274	11495	11726	11946	12177	12398
N92MTW3LF	8714	9337	9710	9918	10117	10308	10507	10698	10897	11088
N92MTW3LLF	8953	9576	9949	10157	10356	10547	10746	10937	11136	11327
N92MTW3LMF	9117	9792	10197	10422	10638	10845	11061	11268	11484	11691
N92MTW3MF	7981	8499	8809	8982	9147	9306	9471	9630	9796	9954
N92MTW3RF	8714	9337	9710	9918	10117	10308	10507	10698	10897	11088
N92MTW3RMF	9117	9792	10197	10422	10638	10845	11061	11268	11484	11691
N92MTW3RRF	8953	9576	9949	10157	10356	10547	10746	10937	11136	11327
N92MTWC2F	6651	6891	7035	7115	7192	7265	7342	7416	7493	7566
N92MTWC3F	8934	9257	9450	9558	9661	9760	9863	9962	10065	10164
N92MTWIN9F	4608	4841	4980	5058	5132	5203	5278	5349	5423	5495

Alliance Program TB133 Fire Rated Pricing

Finishes

IM	Brighton	CW	Cordovan
NM	Natural	DW	Judicial
HN	Honey	MH	Mocha
CL	Caramel	405	Designer White
TF	Truffle	462	Cinder
AC	Autumn	792	Sable
MC	Amber	793	Acorn

To order, specify the following:

1. Chair Model Number
2. Fabric Grade Letter
3. Alliance Pattern Number and Color Number/Name
4. Finish Number (when applicable)

Sample Order Number

<u>N14KKF</u>	<u>A</u>	<u>403901</u>	<u>036</u>	<u>HN</u>
Model Number	Fabric Grade Letter	Alliance Pattern Number	Alliance Color Number	Finish

Model Number

Alliance Program TB133 Price Grades

	A	B	C	D	E	F	G	H	I	J
N92MTWSQ9DF	\$ 3965	\$ 4018	\$ 4064	\$ 4110	\$ 4159	\$ 4214	\$ 4253	\$ 4306	\$ 4363	\$ 4414
N92MTWSQ9LF	3941	3989	4031	4073	4117	4168	4203	4252	4304	4350
N92MTWSQ9RF	3941	3989	4031	4073	4117	4168	4203	4252	4304	4350
N95AACF	3039	3170	3284	3398	3517	3654	3751	3882	4025	4150
N95AAF	2891	3022	3136	3250	3369	3506	3603	3734	3877	4002
N95AALCF	3262	3393	3507	3621	3740	3877	3974	4105	4248	4373
N95AALF	3112	3243	3357	3471	3590	3727	3824	3955	4098	4223
N95AARCF	3262	3393	3507	3621	3740	3877	3974	4105	4248	4373
N95AARF	3112	3243	3357	3471	3590	3727	3824	3955	4098	4223
N95BBBF	4227	4397	4545	4693	4849	5026	5152	5322	5507	5670
N95BBF	3783	3953	4101	4249	4405	4582	4708	4878	5063	5226
N95BBLF	4006	4176	4324	4472	4628	4805	4931	5101	5286	5449
N95BBRF	4006	4176	4324	4472	4628	4805	4931	5101	5286	5449
N95CCBF	5238	5447	5629	5811	6002	6221	6375	6585	6812	7012
N95CCF	4793	5002	5184	5366	5557	5776	5930	6140	6367	6567
N95CCLF	5016	5225	5407	5589	5780	5999	6153	6363	6590	6790
N95CCRF	5016	5225	5407	5589	5780	5999	6153	6363	6590	6790
N95DDCF	1771	1831	1883	1935	1989	2052	2096	2156	2221	2278
N95DDF	1623	1683	1735	1787	1841	1904	1948	2008	2073	2130
N95EEF	2219	2297	2365	2433	2505	2586	2644	2722	2807	2882
N95GGF	3020	3156	3274	3392	3516	3657	3758	3893	4041	4171
N95MACF	2212	2283	2345	2407	2472	2547	2599	2671	2748	2816
N95MAF	2064	2135	2197	2259	2324	2399	2451	2523	2600	2668
N95MALF	2457	2558	2646	2734	2827	2932	3007	3108	3218	3315
N95MALTF	2721	2822	2910	2998	3091	3196	3271	3372	3482	3579
N95MARF	2457	2558	2646	2734	2827	2932	3007	3108	3218	3315
N95MARTF	2721	2822	2910	2998	3091	3196	3271	3372	3482	3579
N95MBF	3130	3300	3448	3596	3752	3929	4055	4225	4410	4573
N95MBLF	3358	3498	3620	3742	3870	4017	4120	4261	4413	4547
N95MBLTF	3621	3761	3883	4005	4133	4280	4383	4524	4676	4810
N95MBRF	3358	3498	3620	3742	3870	4017	4120	4261	4413	4547
N95MBRTF	3621	3761	3883	4005	4133	4280	4383	4524	4676	4810
N95MCF	4052	4222	4370	4518	4674	4851	4977	5147	5332	5495
N95MCLF	4379	4570	4736	4902	5077	5276	5417	5608	5815	5998
N95MCLTF	4643	4834	5000	5166	5341	5540	5681	5872	6079	6262
N95MCRF	4379	4570	4736	4902	5077	5276	5417	5608	5815	5998
N95MCRTF	4643	4834	5000	5166	5341	5540	5681	5872	6079	6262
N95MHAF	1920	1975	2023	2071	2122	2179	2220	2275	2335	2388
N95MHF	1944	2004	2056	2108	2162	2225	2269	2329	2394	2451
N95MJAF	2220	2282	2336	2390	2446	2511	2557	2619	2687	2746
N95MJF	2268	2339	2401	2463	2528	2603	2655	2727	2804	2872
N95MKAF	2824	2895	2957	3019	3084	3159	3211	3283	3360	3428
N95MKF	2970	3069	3155	3241	3332	3435	3508	3607	3714	3809
451F	1472	1548	1614	1680	1750	1829	1885	1961	2043	2116
451TF	1546	1629	1701	1773	1848	1935	1996	2079	2169	2248
452F	1488	1564	1630	1696	1766	1845	1901	1977	2059	2132
452TF	1557	1640	1712	1784	1859	1946	2007	2090	2180	2259

Model Number	Alliance Program TB133 Price Grades									
	K	L	M	N	O	P	Q	R	S	T
N92MTWSQ9DF	\$ 4499	\$ 4672	\$ 4775	\$ 4833	\$ 4888	\$ 4941	\$ 4996	\$ 5049	\$ 5104	\$ 5157
N92MTWSQ9LF	4428	4586	4680	4733	4783	4831	4882	4930	4980	5029
N92MTWSQ9RF	4428	4586	4680	4733	4783	4831	4882	4930	4980	5029
N95AACF	4361	4789	5045	5188	5324	5455	5592	5723	5860	5991
N95AAF	4213	4641	4897	5040	5176	5307	5444	5575	5712	5843
N95AALCF	4584	5012	5268	5411	5547	5678	5815	5946	6083	6214
N95AALF	4434	4862	5118	5261	5397	5528	5665	5796	5933	6064
N95AARCF	4584	5012	5268	5411	5547	5678	5815	5946	6083	6214
N95AARF	4434	4862	5118	5261	5397	5528	5665	5796	5933	6064
N95BBBBF	5944	6499	6832	7017	7195	7365	7542	7713	7890	8060
N95BBF	5500	6055	6388	6573	6751	6921	7098	7269	7446	7616
N95BBLF	5723	6278	6611	6796	6974	7144	7321	7492	7669	7839
N95BBRF	5723	6278	6611	6796	6974	7144	7321	7492	7669	7839
N95CCBF	7349	8032	8441	8669	8887	9096	9315	9524	9742	9952
N95CCF	6904	7587	7996	8224	8442	8651	8870	9079	9297	9507
N95CCLF	7127	7810	8219	8447	8665	8874	9093	9302	9520	9730
N95CCRF	7127	7810	8219	8447	8665	8874	9093	9302	9520	9730
N95DDCF	2374	2569	2686	2751	2813	2873	2936	2995	3058	3118
N95DDF	2226	2421	2538	2603	2665	2725	2788	2847	2910	2970
N95EEF	3008	3263	3416	3501	3583	3661	3742	3821	3902	3980
N95GGF	4389	4832	5097	5245	5386	5522	5663	5799	5941	6076
N95MACF	2931	3164	3303	3381	3455	3526	3601	3672	3746	3818
N95MAF	2783	3016	3155	3233	3307	3378	3453	3524	3598	3670
N95MALF	3478	3808	4006	4116	4222	4323	4428	4530	4635	4736
N95MALTF	3742	4072	4270	4380	4486	4587	4692	4794	4899	5000
N95MARF	3478	3808	4006	4116	4222	4323	4428	4530	4635	4736
N95MARTF	3742	4072	4270	4380	4486	4587	4692	4794	4899	5000
N95MBF	4847	5402	5735	5920	6098	6268	6445	6616	6793	6963
N95MBLF	4773	5231	5505	5658	5804	5944	6091	6231	6377	6518
N95MBLTF	5036	5494	5768	5921	6067	6207	6354	6494	6640	6781
N95MBRF	4773	5231	5505	5658	5804	5944	6091	6231	6377	6518
N95MBRTF	5036	5494	5768	5921	6067	6207	6354	6494	6640	6781
N95MCF	5769	6324	6657	6842	7020	7190	7367	7538	7715	7885
N95MCLF	6305	6928	7301	7509	7708	7899	8098	8289	8488	8679
N95MCLTF	6569	7192	7565	7773	7972	8163	8362	8553	8752	8943
N95MCRF	6305	6928	7301	7509	7708	7899	8098	8289	8488	8679
N95MCRTF	6569	7192	7565	7773	7972	8163	8362	8553	8752	8943
N95MHAF	2477	2657	2765	2825	2883	2938	2995	3051	3108	3163
N95MHF	2547	2742	2859	2924	2986	3046	3109	3168	3231	3291
N95MJAF	2846	3049	3170	3238	3302	3364	3429	3491	3556	3618
N95MJF	2987	3220	3359	3437	3511	3582	3657	3728	3802	3874
N95MKAF	3543	3776	3915	3993	4067	4138	4213	4284	4358	4430
N95MKF	3968	4291	4484	4592	4695	4794	4897	4996	5099	5198
451F	2238	2486	2634	2717	2796	2872	2951	3027	3106	3182
451TF	2381	2651	2813	2903	2989	3072	3159	3241	3328	3411
452F	2254	2502	2650	2733	2812	2888	2967	3043	3122	3198
452TF	2392	2662	2824	2914	3000	3083	3170	3252	3339	3422

COM Yardage Requirements

COM YARDAGE REQUIREMENTS (54" Width – Cut up the roll)

MODEL	Railroaded Contact customer service 800-482-1717 for ydg requirements	Non Directional Or Solid	1"-4" Repeat	5"-11" Repeat	12"-18" Repeat	COL Square Feet
			4" Vertical X 4" Horizontal	11" Vertical X 11" Horizontal	18" Vertical X 18" Horizontal	
N10PSQ1414		0.60	0.70	0.70	0.80	12
N10PSQ1414X	Upholstery	0.60	0.70	0.70	0.80	6
	Back	0.60	0.70	0.70	0.80	6
N10PSQ1414P		0.70	0.70	0.70	0.80	14
N10PSQ1414PX	Upholstery	0.60	0.70	0.70	0.80	6
	Back	0.60	0.70	0.70	0.80	6
	Piping	0.10	0.10	0.10	0.10	2
N10PSQ1414B		0.60	0.70	0.70	0.80	12
N10PSQ1414BX	Upholstery	0.60	0.70	0.70	0.80	6
	Back	0.60	0.70	0.70	0.80	6
	Accent	0.10	0.10	0.10	0.10	1
N10PSQ1414BP		0.70	0.70	0.70	0.80	14
N10PSQ1414PBX	Upholstery	0.60	0.70	0.70	0.80	6
	Back	0.60	0.70	0.70	0.80	6
	Piping	0.10	0.10	0.10	0.10	2
	Accent	0.10	0.10	0.10	0.10	1
N10PRT1508		0.40	0.50	0.60	1.30	8
N10PRT1509X	Upholstery	0.40	0.50	0.60	0.80	4
	Back	0.40	0.50	0.60	0.80	4
N10PRT1508L, N10PRT1508R, N10PRT1508C		0.40	0.50	0.60	1.30	8
N10PRT1508LX, N10PRT1508RX, N10PRT1508CX	Upholstery	0.40	0.50	0.60	0.80	4
	Back	0.40	0.50	0.60	0.80	4
	Accent	0.40	0.50	0.60	0.80	4
N10PRT1508P		0.50	0.50	0.60	1.30	10
N10PRT1509PX	Upholstery	0.40	0.50	0.60	0.80	4
	Back	0.40	0.50	0.60	0.80	4
	Piping	0.10	0.10	0.10	0.10	2
N10PRT1508LP, N10PRT1508RP, N10PRT1508CP		0.50	0.50	0.60	1.30	10
N10PRT1508LPX, N10PRT1508RPX, N10PRT1508CPX	Upholstery	0.40	0.50	0.60	0.80	4
	Back	0.40	0.50	0.60	0.80	4
	Piping	0.10	0.10	0.10	0.10	2
	Accent	0.40	0.50	0.60	0.80	4
N10PWD1816		0.90	1.20	1.50	1.80	18
N10PWD1816X	Upholstery	0.70	0.70	1.00	1.20	7
	Back	0.60	0.60	0.90	0.80	6
	Accent	0.60	0.60	0.90	0.80	6
N10PWD2116		1.10	1.20	1.50	1.80	22
N10PWD2116X	Upholstery	0.70	0.70	1.00	1.20	7
	Back	0.60	0.60	0.90	0.80	6
	Accent	0.60	0.60	0.90	0.80	6
N10PWD2416		1.20	1.50	1.90	1.80	24
N10PWD2416X	Upholstery	0.70	0.70	1.00	1.20	7
	Back	0.60	0.60	0.90	0.80	6
	Accent	0.60	0.60	0.90	0.80	6
N10PBL1806		0.60	0.70	0.70	0.90	12
N10PBL1806X	Upholstery	0.60	0.70	0.70	0.90	6
	Accent	0.30	0.30	0.50	0.70	3
N10PBL1806P		0.60	0.70	0.70	0.90	12
N10PBL1806PX	Upholstery	0.60	0.70	0.70	0.90	6
	Piping	0.10	0.10	0.10	0.10	2
	Accent	0.30	0.30	0.50	0.70	3
N12AAC(S)		1.20	1.50	1.90	2.10	24
N12AAY		1.20	1.50	1.90	2.10	24
N12AR		1.20	1.50	1.90	2.10	24
N12ARS		1.20	1.50	1.90	2.10	24

COM Yardage Requirements

COM YARDAGE REQUIREMENTS (54" Width – Cut up the roll)

MODEL	Railroaded	Non Directional	1"-4" Repeat	5"-11" Repeat	12"-18" Repeat	COL Square Feet
	Contact customer service 800-482-1717 for ydg requirements	Or Solid	4" Vertical X 4" Horizontal	11" Vertical X 11" Horizontal	18" Vertical X 18" Horizontal	
N12ARY		1.20	1.50	1.90	2.10	24
N12BBC(S)		1.50	1.70	2.00	3.00	31
N12BBY		1.50	1.70	2.00	3.00	31
N12BR		1.50	1.70	2.00	3.00	31
N12BRS		1.50	1.70	2.00	3.00	31
N12BRY		1.50	1.70	2.00	3.00	31
N12CCC(S)		1.20	1.50	1.90	2.10	24
N12CCY		1.20	1.50	1.90	2.10	24
N12CR		1.20	1.50	1.90	2.10	24
N12CRS		1.20	1.50	1.90	2.10	24
N12CRY		1.20	1.50	1.90	2.10	24
N12DDC(S)		1.50	1.70	2.00	3.00	31
N12DDY		1.50	1.70	2.00	3.00	31
N12DR		1.50	1.70	2.00	3.00	31
N12DRS		1.50	1.70	2.00	3.00	31
N12DRY		1.50	1.70	2.00	3.00	31
N12EEC(S)		1.30	1.50	2.00	2.10	26
N12ER		1.30	1.50	2.00	2.10	26
N12ERS		1.30	1.50	2.00	2.10	26
N12HHC(S)		1.60	1.70	2.50	3.00	33
N12HR		1.60	1.70	2.50	3.00	33
N12HRS		1.60	1.70	2.50	3.00	33
N12JJC(S)		1.20	1.50	1.90	2.10	24
N12JJCE		1.20	1.50	1.90	2.10	24
N12JJCES		1.20	1.50	1.90	2.10	24
N12JJY		1.20	1.50	1.90	2.10	24
N12JJYE		1.20	1.50	1.90	2.10	24
N12JR		1.20	1.50	1.90	2.10	24
N12JRE		1.20	1.50	1.90	2.10	24
N12JRES		1.20	1.50	1.90	2.10	24
N12JRS		1.20	1.50	1.90	2.10	24
N12JRY		1.20	1.50	1.90	2.10	24
N12JRYE		1.20	1.50	1.90	2.10	24
N12KKC(S)		1.50	1.70	2.00	3.00	31
N12KKCE		1.50	1.70	2.00	3.00	31
N12KKCES		1.50	1.70	2.00	3.00	31
N12KKY		1.50	1.70	2.00	3.00	31
N12KKYE		1.50	1.70	2.00	3.00	31
N12KR		1.50	1.70	2.00	3.00	31
N12KRE		1.50	1.70	2.00	3.00	31
N12KRES		1.50	1.70	2.00	3.00	31
N12KRS		1.50	1.70	2.00	3.00	31
N12KRY		1.50	1.70	2.00	3.00	31
N12KRYE		1.50	1.70	2.00	3.00	31
N12MMC(S)		1.30	1.50	2.00	2.10	26
N12MMCE		1.30	1.50	2.00	2.10	26
N12MMCES		1.30	1.50	2.00	2.10	26
N12MR		1.30	1.50	2.00	2.10	26
N12MRE		1.30	1.50	2.00	2.10	26
N12MRES		1.30	1.50	2.00	2.10	26
N12MRS		1.30	1.50	2.00	2.10	26
N12PPC(S)		1.60	1.70	2.50	3.00	33

COM Yardage Requirements

COM YARDAGE REQUIREMENTS (54" Width – Cut up the roll)

MODEL	Railroaded Contact customer service 800-482-1717 for ydg requirements	Non Directional Or Solid	1"-4" Repeat	5"-11" Repeat	12"-18" Repeat	COL Square Feet
			4" Vertical X 4" Horizontal	11" Vertical X 11" Horizontal	18" Vertical X 18" Horizontal	
N12PPCE		1.60	1.70	2.50	3.00	33
N12PPCES		1.60	1.70	2.50	3.00	33
N12PR		1.60	1.70	2.50	3.00	33
N12PRE		1.60	1.70	2.50	3.00	33
N12PRES		1.60	1.70	2.50	3.00	33
N12PRS		1.60	1.70	2.50	3.00	33
N12QQ		1.40	1.60	2.20	3.00	28
N12RR		1.10	1.50	1.90	2.00	22
N13CCC(S)		1.20	1.50	1.90	2.10	24
N13CCY		1.20	1.50	1.90	2.10	24
N13CR		1.20	1.50	1.90	2.10	24
N13CRS		1.20	1.50	1.90	2.10	24
N13CRY		1.20	1.50	1.90	2.10	24
N13DDC(S)		1.50	1.70	2.00	3.00	31
N13DDY		1.50	1.70	2.00	3.00	31
N13DR		1.50	1.70	2.00	3.00	31
N13DRS		1.50	1.70	2.00	3.00	31
N13DRY		1.50	1.70	2.00	3.00	31
N13EEC(S)		1.30	1.50	2.00	2.10	26
N13ER		1.30	1.50	2.00	2.10	26
N13ERS		1.30	1.50	2.00	2.10	26
N13HHC(S)		1.60	1.70	2.50	3.00	33
N13HR		1.60	1.70	2.50	3.00	33
N13HRS		1.60	1.70	2.50	3.00	33
N13JJC(S)		1.20	1.50	1.90	2.10	24
N13JJY		1.20	1.50	1.90	2.10	24
N13JR		1.20	1.50	1.90	2.10	24
N13JRS		1.20	1.50	1.90	2.10	24
N13JRY		1.20	1.50	1.90	2.10	24
N13KKC(S)		1.50	1.70	2.00	3.00	31
N13KKY		1.50	1.70	2.00	3.00	31
N13KR		1.50	1.70	2.00	3.00	31
N13KRS		1.50	1.70	2.00	3.00	31
N13KRY		1.50	1.70	2.00	3.00	31
N13MMC(S)		1.30	1.50	2.00	2.10	26
N13MR		1.30	1.50	2.00	2.10	26
N13MRS		1.30	1.50	2.00	2.10	26
N13PPC(S)		1.60	1.70	2.50	3.00	33
N13PR		1.60	1.70	2.50	3.00	33
N13PRS		1.60	1.70	2.50	3.00	33
N14AAC(S)		1.20	1.50	1.90	2.10	24
N14AAY		1.20	1.50	1.90	2.10	24
N14AR		1.20	1.50	1.90	2.10	24
N14ARS		1.20	1.50	1.90	2.10	24
N14ARY		1.20	1.50	1.90	2.10	24
N14BBC(S)		1.50	1.70	2.00	3.00	31
N14BBY		1.50	1.70	2.00	3.00	31
N14BR		1.50	1.70	2.00	3.00	31
N14BRS		1.50	1.70	2.00	3.00	31
N14BRY		1.50	1.70	2.00	3.00	31
N14CCC(S)		1.20	1.50	1.90	2.10	24
N14CCY		1.20	1.50	1.90	2.10	24

COM Yardage Requirements

COM YARDAGE REQUIREMENTS (54" Width – Cut up the roll)

MODEL	Railroaded Contact customer service 800-482-1717 for ydg requirements	Non Directional Or Solid	1"-4" Repeat	5"-11" Repeat	12"-18" Repeat	COL Square Feet
			4" Vertical X 4" Horizontal	11" Vertical X 11" Horizontal	18" Vertical X 18" Horizontal	
N14CR		1.20	1.50	1.90	2.10	24
N14CRS		1.20	1.50	1.90	2.10	24
N14CRY		1.20	1.50	1.90	2.10	24
N14DDC(S)		1.50	1.70	2.00	3.00	31
N14DDY		1.50	1.70	2.00	3.00	31
N14DR		1.50	1.70	2.00	3.00	31
N14DRS		1.50	1.70	2.00	3.00	31
N14DRY		1.50	1.70	2.00	3.00	31
N14EEC(S)		1.30	1.50	2.00	2.10	26
N14ER		1.30	1.50	2.00	2.10	26
N14ERS		1.30	1.50	2.00	2.10	26
N14HHC(S)		1.60	1.70	2.50	3.00	33
N14HR		1.60	1.70	2.50	3.00	33
N14HRS		1.60	1.70	2.50	3.00	33
N14JJC(S)		1.20	1.50	1.90	2.10	24
N14JJY		1.20	1.50	1.90	2.10	24
N14JR		1.20	1.50	1.90	2.10	24
N14JRS		1.20	1.50	1.90	2.10	24
N14JRY		1.20	1.50	1.90	2.10	24
N14KKC(S)		1.50	1.70	2.00	3.00	31
N14KKY		1.50	1.70	2.00	3.00	31
N14KR		1.50	1.70	2.00	3.00	31
N14KRS		1.50	1.70	2.00	3.00	31
N14KRY		1.50	1.70	2.00	3.00	31
N14MMC(S)		1.30	1.50	2.00	2.10	26
N14MR		1.30	1.50	2.00	2.10	26
N14MRS		1.30	1.50	2.00	2.10	26
N14PPC(S)		1.60	1.70	2.50	3.00	33
N14PR		1.60	1.70	2.50	3.00	33
N14PRS		1.60	1.70	2.50	3.00	33
N14QQ		1.40	1.60	2.20	3.00	28
N14RR		1.20	1.50	1.90	2.00	22
N15AAY		0.90	1.10	1.30	1.20	18
N15ARY		0.90	1.10	1.30	1.20	18
N15CCY		0.90	1.10	1.30	1.20	18
N15CRY		0.90	1.10	1.30	1.20	18
N15EE		0.90	1.10	1.30	1.20	18
N15EES		0.90	1.10	1.30	1.20	18
N15ER		0.90	1.10	1.30	1.20	18
N15ERS		0.90	1.10	1.30	1.20	18
N15GG		0.90	1.10	1.30	1.20	18
N15GGS		0.90	1.10	1.30	1.20	18
N15GR		0.90	1.10	1.30	1.20	18
N15GRS		0.90	1.10	1.30	1.20	18
N15HH		0.90	1.10	1.30	1.20	18
N15HHS		0.90	1.10	1.30	1.20	18
N15HR		0.90	1.10	1.30	1.20	18
N15HRS		0.90	1.10	1.30	1.20	18
N15JJY		0.90	1.10	1.30	1.20	18
N15JJYE		0.90	1.10	1.30	1.20	18
N15JRY		0.90	1.10	1.30	1.20	18
N15JRYE		0.90	1.10	1.30	1.20	18

COM Yardage Requirements

COM YARDAGE REQUIREMENTS (54" Width – Cut up the roll)

MODEL	Railroaded Contact customer service 800-482-1717 for ydg requirements	Non Directional Or Solid	1"-4" Repeat	5"-11" Repeat	12"-18" Repeat	COL Square Feet
			4" Vertical X 4" Horizontal	11" Vertical X 11" Horizontal	18" Vertical X 18" Horizontal	
N15LL		0.90	1.10	1.30	1.20	18
N15LLS		0.90	1.10	1.30	1.20	18
N15LR		0.90	1.10	1.30	1.20	18
N15LRS		0.90	1.10	1.30	1.20	18
N15MM		0.90	1.10	1.30	1.20	18
N15MME		0.90	1.10	1.30	1.20	18
N15MMES		0.90	1.10	1.30	1.20	18
N15MMS		0.90	1.10	1.30	1.20	18
N15MR		0.90	1.10	1.30	1.20	18
N15MRE		0.90	1.10	1.30	1.20	18
N15MRES		0.90	1.10	1.30	1.20	18
N15MRS		0.90	1.10	1.30	1.20	18
N15PP		0.90	1.10	1.30	1.20	18
N15PPE		0.90	1.10	1.30	1.20	18
N15PPES		0.90	1.10	1.30	1.20	18
N15PPS		0.90	1.10	1.30	1.20	18
N15PR		0.90	1.10	1.30	1.20	18
N15PRE		0.90	1.10	1.30	1.20	18
N15PRES		0.90	1.10	1.30	1.20	18
N15PRS		0.90	1.10	1.30	1.20	18
N15RR		0.90	1.00	1.20	1.10	18
N16CCY		0.90	1.10	1.30	1.20	18
N16CRY		0.90	1.10	1.30	1.20	18
N16EE		0.90	1.10	1.30	1.20	18
N16EES		0.90	1.10	1.30	1.20	18
N16ER		0.90	1.10	1.30	1.20	18
N16ERS		0.90	1.10	1.30	1.20	18
N16HH		0.90	1.10	1.30	1.20	18
N16HHS		0.90	1.10	1.30	1.20	18
N16HR		0.90	1.10	1.30	1.20	18
N16HRS		0.90	1.10	1.30	1.20	18
N16JJY		0.90	1.10	1.30	1.20	18
N16JRY		0.90	1.10	1.30	1.20	18
N16MM		0.90	1.10	1.30	1.20	18
N16MMS		0.90	1.10	1.30	1.20	18
N16MR		0.90	1.10	1.30	1.20	18
N16MRS		0.90	1.10	1.30	1.20	18
N16PP		0.90	1.10	1.30	1.20	18
N16PPS		0.90	1.10	1.30	1.20	18
N16PR		0.90	1.10	1.30	1.20	18
N16PRS		0.90	1.10	1.30	1.20	18
N17AAY		0.90	1.10	1.30	1.20	18
N17ARY		0.90	1.10	1.30	1.20	18
N17CCY		0.90	1.10	1.30	1.20	18
N17CRY		0.90	1.10	1.30	1.20	18
N17EE		0.90	1.10	1.30	1.20	18
N17EES		0.90	1.10	1.30	1.20	18
N17ER		0.90	1.10	1.30	1.20	18
N17ERS		0.90	1.10	1.30	1.20	18
N17GG		0.90	1.10	1.30	1.20	18
N17GGS		0.90	1.10	1.30	1.20	18
N17GR		0.90	1.10	1.30	1.20	18

COM Yardage Requirements

COM YARDAGE REQUIREMENTS (54" Width – Cut up the roll)

MODEL	Railroaded Contact customer service 800-482-1717 for ydg requirements	Non Directional Or Solid	1"-4" Repeat	5"-11" Repeat	12"-18" Repeat	COL Square Feet
			4" Vertical X 4" Horizontal	11" Vertical X 11" Horizontal	18" Vertical X 18" Horizontal	
N17GRS		0.90	1.10	1.30	1.20	18
N17HH		0.90	1.10	1.30	1.20	18
N17HHS		0.90	1.10	1.30	1.20	18
N17HR		0.90	1.10	1.30	1.20	18
N17HRS		0.90	1.10	1.30	1.20	18
N17JJY		0.90	1.10	1.30	1.20	18
N17JRY		0.90	1.10	1.30	1.20	18
N17LL		0.90	1.10	1.30	1.20	18
N17LLS		0.90	1.10	1.30	1.20	18
N17LR		0.90	1.10	1.30	1.20	18
N17LRS		0.90	1.10	1.30	1.20	18
N17MM		0.90	1.10	1.30	1.20	18
N17MMS		0.90	1.10	1.30	1.20	18
N17MR		0.90	1.10	1.30	1.20	18
N17MRS		0.90	1.10	1.30	1.20	18
N17PP		0.90	1.10	1.30	1.20	18
N17PPS		0.90	1.10	1.30	1.20	18
N17PR		0.90	1.10	1.30	1.20	18
N17PRS		0.90	1.10	1.30	1.20	18
N17RR		0.90	1.00	1.20	1.10	18
N21AAUC, N21AAUG						
N21AATUC, N21AATUG						
N21BBUC, N21BBUG						
N21BBTUC, N21BBTUG						
N21CCUC, N21CCUG, N21UPH		0.70	0.70	0.70	0.90	14
N22HMM, N22HMA		0.90	1.10	1.40	2.40	18
N23AAC, N23AACY		0.90	1.80	2.00	2.00	18
N23BBC, N23BBCY		1.50	2.50	2.90	2.90	30
N23CCC, N23CCCY		0.90	1.80	2.00	2.00	18
N23CCCD		0.90	1.80	2.00	2.00	18
N23CCCYD		0.90	1.80	2.00	2.00	18
N23DDC		1.00	1.80	2.00	2.00	19
N23DDCD		1.00	1.80	2.00	2.00	19
N23EEC, N23EECY		1.50	2.50	2.90	2.90	30
N23EECD		1.50	2.50	2.90	2.90	30
N23EECYD		1.50	2.50	2.90	2.90	30
N23HHC		1.60	2.60	2.90	3.00	31
N23HHCD		1.60	2.60	2.90	3.00	31
N23JJC		0.90	1.80	2.00	2.00	18
N23KKC		1.00	1.80	2.00	2.00	19
N23MMC		1.50	2.50	2.90	2.90	30
N23PPC		1.60	2.60	2.90	3.00	31
N23RRC		1.60	2.60	2.90	3.00	31
N23SSC		1.00	1.80	2.00	2.00	19
N24AAC		0.90	1.80	2.00	2.00	18
N24BBC		1.50	2.50	2.90	2.90	30
N24CCC		0.90	1.80	2.00	2.00	18
N24CCCD		0.90	1.80	2.00	2.00	18
N24DDC		1.00	1.80	2.00	2.00	19
N24DDCD		1.00	1.80	2.00	2.00	19
N24EEC		1.50	2.50	2.90	2.90	30
N24EECD		1.50	2.50	2.90	2.90	30
N24HHC		1.60	2.60	2.90	3.00	31

COM Yardage Requirements

COM YARDAGE REQUIREMENTS (54" Width – Cut up the roll)

MODEL	Railroaded Contact customer service 800-482-1717 for ydg requirements	Non Directional Or Solid	1"-4" Repeat	5"-11" Repeat	12"-18" Repeat	COL Square Feet
			4" Vertical X 4" Horizontal	11" Vertical X 11" Horizontal	18" Vertical X 18" Horizontal	
N24HHCD		1.60	2.60	2.90	3.00	31
N24JJC		0.90	1.80	2.00	2.00	18
N24KKC		1.00	1.80	2.00	2.00	19
N24MMC		1.50	2.50	2.90	2.90	30
N24PPC		1.60	2.60	2.90	3.00	31
N24RRC		1.60	2.60	2.90	3.00	31
N24SSC		1.00	1.80	2.00	2.00	19
N25AAC, N25AACY		0.90	1.80	2.00	2.00	18
N25BBC, N25BBCY		1.50	2.50	2.90	2.90	30
N25CCC, N25CCCX, N25CCCY		0.90	1.80	2.00	2.00	18
N25CCCD		0.90	1.80	2.00	2.00	18
N25CCCXD		0.90	1.80	2.00	2.00	18
N25CCCYD		0.90	1.80	2.00	2.00	18
N25DDC, N25DDCX		1.00	1.80	2.00	2.00	19
N25DDCD		1.00	1.80	2.00	2.00	19
N25DDCXD		1.00	1.80	2.00	2.00	19
N25EEC, N25EECY		1.50	2.50	2.90	2.90	30
N25EECD		1.50	2.50	2.90	2.90	30
N25EECYD		1.50	2.50	2.90	2.90	30
N25HHC		1.60	2.60	2.90	3.00	31
N25HHCD		1.60	2.60	2.90	3.00	31
N25JJC		0.90	1.80	2.00	2.00	18
N25KKC		1.00	1.80	2.00	2.00	19
N25MMC		1.50	2.50	2.90	2.90	30
N25PPC		1.60	2.60	2.90	3.00	31
N25RRC		1.60	2.60	2.90	3.00	31
N25SSC		1.00	1.80	2.00	2.00	19
N26AAC		0.90	1.80	2.00	2.00	18
N26BBC		1.50	2.50	2.90	2.90	30
N26CCC		0.90	1.80	2.00	2.00	18
N26CCCD		0.90	1.80	2.00	2.00	18
N26DDC, N26DDCX		1.00	1.80	2.00	2.00	19
N26DDCD		1.00	1.80	2.00	2.00	19
N26DDCXD		1.00	1.80	2.00	2.00	19
N26EEC		1.50	2.50	2.90	2.90	30
N26EECD		1.50	2.50	2.90	2.90	30
N26HHC		1.60	2.60	2.90	3.00	31
N26HHCD		1.60	2.60	2.90	3.00	31
N26JJC		0.90	1.80	2.00	2.00	18
N26KKC, N26KKCX		1.00	1.80	2.00	2.00	19
N26MMC		1.50	2.50	2.90	2.90	30
N26PPC		1.60	2.60	2.90	3.00	31
N26RRC		1.60	2.60	2.90	3.00	31
N26SSC		1.00	1.80	2.00	2.00	19

COM Yardage Requirements

COM YARDAGE REQUIREMENTS (54" Width – Cut up the roll)

MODEL	Railroaded	Non Directional	1"-4" Repeat	5"-11" Repeat	12"-18" Repeat	COL Square Feet
	Contact customer service 800-482-1717 for ydg requirements	Or Solid	4" Vertical X 4" Horizontal	11" Vertical X 11" Horizontal	18" Vertical X 18" Horizontal	
N30HM1SP, N30HM1SSP N30HM1SN, N30HM1SSN N30HM2SP, N30HM2SSP N30HM2SN, N30HM2SSN N30HM3SP, N30HM3SSP N30HM3SN, N30HM3SSN N30HM9SP, N30HM9SSP H30HM9SN, N30HM9SSN N30HM8SN, N30HM8SSN N30HML1SP, N30HML1SSP N30HML1SN, N30HML1SSN N30HML2SP, N30HML2SSP N30HML2SN, N30HML2SSN N30HML3SP, N30HML3SSP N30HML3SN, N30HML3SSN N30HML9SP, N30HML9SSP N30HML9SN, N30HML9SSN N30HML8SN, N30HML8SSN		0.80	1.00	1.20	2.10	16
N30HP1SP, N30HP1SSP N30HP1SN, N30HP1SSN N30HP2SP, N30HP2SSP N30HP2SN, N30HP2SSN N30HP3SP, N30HP3SSP N30HP3SN, N30HP3SSN N30HP9SP, N30HP9SSP N30HP9SN, N30HP9SSN N30HP8SN, N30HP8SSN		1.30	1.50	2.10	3.40	26
N30HP1SPX, N30HP1SSPX N30HP1SNX, N30HP1SSNX N30HP2SPX, N30HP2SSPX N30HP2SNX, N30HP2SSNX N30HP3SPX, N30HP3SSPX N30HP3SNX, N30HP3SSNX N30HP9SPX, N30HP9SSPX N30HP9SNX, N30HP9SSNX N30HP8SNX, N30HP8SSNX	Back Seat	0.90 0.80	1.10 1.00	1.50 1.20	2.50 2.10	18 16
N30HU1SP, N30HU1SSP N30HU1SN, N30HU1SSN N30HU2SP, N30HU2SSP N30HU2SN, N30HU2SSN N30HU3SP, N30HU3SSP N30HU3SN, N30HU3SSN N30HU9SP, N30HU9SSP N30HU9SN, N30HU9SSN N30HU8SN, N30HU8SSN		1.50	1.80	2.60	4.40	30
N30HU1SPX, N30HU1SSPX N30HU1SNX, N30HU1SSNX N30HU2SPX, N30HU2SSPX N30HU2SNX, N30HU2SSNX N30HU3SPX, N30HU3SSPX N30HU3SNX, N30HU3SSNX N30HU9SPX, N30HU9SSPX N30HU9SNX, N30HU9SSNX N30HU8SNX, N30HU8SSNX	Back Extreme Back Seat	0.90 0.60 0.80	1.10 1.00 1.00	1.50 1.40 1.20	2.50 1.50 2.10	18 18 16

COM Yardage Requirements

COM YARDAGE REQUIREMENTS (54" Width – Cut up the roll)

MODEL	Railroaded Contact customer service 800-482-1717 for ydg requirements	Non Directional Or Solid	1"-4" Repeat 4" Vertical X 4" Horizontal	5"-11" Repeat 11" Vertical X 11" Horizontal	12"-18" Repeat Or 18" Vertical X 18" Horizontal	COL Square Feet
N30MP1SP, N30MP1SSP N30MP1SN, N30MP1SSN N30MP2SP, N30MP2SSP N30MP2SN, N30MP2SSN N30MP3SP, N30MP3SSP N30MP3SN, N30MP3SSN N30MP9SP, N30MP9SSP N30MP9SN, N30MP9SSN N30MP8SN, N30MP8SSN N30SP1SP, N30SP1SPG N30SP1SN, N30SP1SNG N30SP2SP, N30SP2SPG N30SP2SN, N30SP2SNG N30SP3SP, N30SP3SPG N30SP3SN, N30SP3SNG N30SP9SP, N30SP9SPG N30SP9SN, N30SP9SNG N30SP8SN, N30SP8SNG		1.20	1.50	2.20	3.00	24
N30MP1SPX, N30MP1SSPX N30MP1SNX, N30MP1SSNX N30MP2SPX, N30MP2SSPX N30MP2SNX, N30MP2SSNX N30MP3SPX, N30MP3SSPX N30MP3SNX, N30MP3SSNX N30MP9SPX, N30MP9SSPX N30MP9SNX, N30MP9SSNX N30MP8SNX, N30MP8SSNX N30SP1SPX, N30SP1SPGX N30SP1SNX, N30SP1SNGX N30SP2SPX, N30SP2SPGX N30SP2SNX, N30SP2SNGX N30SP3SPX, N30SP3SPGX N30SP3SNX, N30SP3SNGX N30SP9SPX, N30SP9SPGX N30SP9SNX, N30SP9SNGX N30SP8SNX, N30SP8SNGX	Back Seat	0.80 0.80	0.90 1.00	1.40 1.20	1.90 2.10	16 16
N30MU1SP, N30MU1SSP N30MU1SN, N30MU1SSN N30MU2SP, N30MU2SSP N30MU2SN, N30MU2SSN N30MU3SP, N30MU3SSP N30MU3SN, N30MU3SSN N30MU9SP, N30MU9SSP N30MU9SN, N30MU9SSN N30MU8SN, N30MU8SSN N30SU1SP, N30SU1SPG N30SU1SN, N30SU1SNG N30SU2SP, N30SU2SPG N30SU2SN, N30SU2SNG N30SU3SP, N30SU3SPG N30SU3SN, N30SU3SNG N30SU9SP, N30SU9SPG N30SU9SN, N30SU9SNG N30SU8SN, N30SU8SNG		1.40	1.60	2.60	3.60	28

COM Yardage Requirements

COM YARDAGE REQUIREMENTS (54" Width – Cut up the roll)

MODEL	Railroaded	Non Directional	1"-4" Repeat	5"-11" Repeat	12"-18" Repeat	COL Square Feet
	Contact customer service 800-482-1717 for ydg requirements	Or Solid	4" Vertical X 4" Horizontal	11" Vertical X 11" Horizontal	18" Vertical X 18" Horizontal	
N30MU1SPX, N30MU1SSPX N30MU1SNX, N30MU1SSNX N30MU2SPX, N30MU2SSPX N30MU2SNX, N30MU2SSNX N30MU3SPX, N30MU3SSPX N30MU3SNX, N30MU3SSNX N30MU9SPX, N30MU9SSPX N30MU9SNX, N30MU9SSNX N30MU8SNX, N30MU8SSNX N30SU1SPX, N30SU1SPGX N30SU1SNX, N30SU1SNGX N30SU2SPX, N30SU2SPGX N30SU2SNX, N30SU2SNGX N30SU3SPX, N30SU3SPGX N30SU3SNX, N30SU3SNGX						
N30SU9SPX, N30SU9SPGX N30SU9SNX, N30SU9SNGX N30SU8SNX, N30SU8SNGX	Back Extreme Back Seat	0.80 0.80 0.80	0.90 1.00 1.00	1.40 1.30 1.20	1.90 1.40 2.10	16 16 16
N30GU1UPC, N30GU1UP N30GU1UNC, N30GU1UN N30GU9UPC, N30GU9UP N30GU9UNC, N30GU9UN			0.90	1.20	1.80	2.80 18
N30GU1UPCX, N30GU1UPX N30GU1UNCX, N30GU1UNX N30GU9UPCX, N30GU9UPX N30GU9UNCX, N30GU9UNX	Back Extreme Back Seat	0.60 0.40 0.90	0.80 0.60 1.10	1.20 0.90 1.40	1.80 1.30 2.40	12 8 18
N30GM1UPC, N30GM1UP N30GM1UNC, N30GM1UN N30GM9UPC, N30GM9UP N30GM9UNC, N30GM9UN		0.90	1.10	1.40	2.40	18
N30GP1UPC, N30GP1UP N30GP1UNC, N30GP1UN N30GP9UPC, N30GP9UP N30GP9UNC, N30GP9UN		0.90	1.20	1.70	2.80	18
N30GP1UPCX, N30GP1UPX N30GP1UNCX, N30GP1UNX N30GP9UPCX, N30GP9UPX N30GP9UNCX, N30GP9UNX	Back Seat	0.60 0.90	0.80 1.10	1.20 1.40	1.80 2.40	12 18
N30GP1PPC, N30GP1PP N30GP1PNC, N30GP1PN N30GP9PPC, N30GP9PP N30GP9PNC, N30GP9PN		0.60	0.80	1.20	1.80	12
N30GU1PPC, N30GU1PP N30GU1PNC, N30GU1PN N30GU9PPC, N30GU9PP N30GU9PNC, N30GU9PN		0.60	0.80	1.20	1.80	12
N30GU1PPCX, N30GU1PPX N30GU1PNCX, N30GU1PNX N30GU9PPCX, N30GU9PPX	Back Extreme Back	0.60 0.40	0.80 0.60	1.20 0.90	1.80 1.30	12 8
N32AAM, N32AAW, N32BBM, N32BBW, N32CCML, N32CCMR, N32CCWL, N32CCWR, N32DDMR, N32DDML, N32DDWR, N32DDWL		4.90	5.60	7.30	8.90	98
N32SAAM, N32SAAW, N32SBBM, N32SBBW, N32SCCML, N32SCCMR, N32SCCWL, N32SCCWR, N32SDDMR, N32SDDML, N32SDDWR, N32SDDWL		5.00	6.40	6.90	8.30	100

COM Yardage

COM Yardage Requirements

COM YARDAGE REQUIREMENTS (54" Width – Cut up the roll)

MODEL	Railroaded Contact customer service 800-482-1717 for ydg requirements	Non Directional Or Solid	1"-4" Repeat		5"-11" Repeat		12"-18" Repeat		COL Square Feet
			4" Vertical X 4" Horizontal	4" Horizontal	11" Vertical X 11" Horizontal	11" Horizontal	18" Vertical X 18" Horizontal	18" Horizontal	
N32HHM, N32HHW, N32JJMR, N32JJML, N32JJMB, N32JJWR, N32JJWL, N32JJWB		9.00	10.00	10.70	12.30	179			
N32SHHM, N32SHHW, N32SJMR, N32SJML, N32SJM B, N32SJWR, N32SJWL, N32SJWB		9.30	10.80	10.90	13.20	185			
N32LLM, N32LLW, N32MMMR, N32MMML, N32MMMB, N32MMWR, N32MMWL, N32MMWB		8.90	13.50	14.70	16.90	177			
N32SLLM, N32SLLW, N32SMMMR, N32SMMML, N32SMMMB, N32SMMWR, N32SMMWL, N32SMMWB		8.60	10.90	15.50	17.80	171			
N32AAMX, N32AAWX, N32BBMX, N32BBWX, N32CCMLX, N32CCMRX, N32CCWLX, N32CCWRX, N32DDMRX, N32DDMLX, N32DDWRX, N32DDWLX	Arm Seat Back	2.80 1.20 2.00	3.40 1.80 2.20	3.80 2.10 2.50	6.00 2.40 2.20	56 24 40			
N32SAAMX, N32SAAWX, N32SBBMX, N32SBBWX, N32SCCMLX, N32SCCMRX, N32SCCWLX, N32SCCWRX, N32SDDMRX, N32SDDMLX, N32SDDWRX, N32SDDWLX	Arm Seat Back	3.00 1.60 1.90	3.10 1.70 2.00	3.40 2.40 2.10	4.00 3.40 2.40	60 32 38			
N32HHMX, N32HHWX, N32JJMRX, N32JJMLX, N32JJMBX, N32JJWRX, N32JJWLX, N32JJWBX	Arm Seat Back	2.80 2.90 3.90	3.40 3.40 4.20	3.80 3.90 5.00	6.00 2.90 5.20	56 58 78			
N32SHHMX, N32SHHWX, N32SJMRX, N32SJMLX, N32SJM B, N32SJWRX, N32SJWLX, N32SJWBX	Arm Seat Back	3.00 3.70 3.70	3.10 3.90 3.90	3.40 4.90 4.10	4.00 6.20 5.10	60 74 74			
N32LLMX, N32LLWX, N32MMMRX, N32MMMLX, N32MMMBX, N32MMWRX, N32MMWLX, N32MMWBX	Arm Seat Back	2.80 3.40 3.90	3.40 4.80 6.30	3.80 5.00 7.40	6.00 6.40 6.20	56 68 78			
N32SLLMX, N32SLLWX, N32SMMMRX, N32SMMMLX, N32SMMMBX, N32SMMWRX, N32SMMWLX, N32SMMWBX	Arm Seat Back	3.00 3.40 3.70	3.10 4.60 3.80	3.40 7.30 5.80	4.00 9.40 6.40	60 68 74			
N32AAMS, N32AAWS, N32BBMS, N32BBWS, N32CCMLS, N32CCMRS, N32CCWLS, N32CCWRS, N32DDMRS, N32DDMLS, N32DDWRS, N32DDWLS		5.00	6.20	7.80	9.00	100			
N32SAAMS, N32SAAWS, N32SBBMS, N32SBBWS, N32SCCMLS, N32SCCMRS, N32SCCWLS, N32SCCWRS, N32SDDMRS, N32SDDMLS, N32SDDWRS, N32SDDWLS		5.40	6.10	7.20	8.10	107.5			
N32HHMS, N32HHWS, N32JJMRS, N32JJMLS, N32JJMBS, N32JJWRS, N32JJWLS, N32JJWBS		10.10	11.00	12.30	14.50	201			

COM Yardage Requirements

COM YARDAGE REQUIREMENTS (54" Width – Cut up the roll)

MODEL	Railroaded Contact customer service 800-482-1717 for ydg requirements	Non Directional Or Solid	1"-4" Repeat 4" Vertical X 4" Horizontal	5"-11" Repeat 11" Vertical X 11" Horizontal	12"-18" Repeat 18" Vertical X 18" Horizontal	COL Square Feet
N32SHHMS, N32SHHWS, N32SJJMRS, N32SJJMLS, N32SJJMBS, N32SJJWRS, N32SJJWLS, N32SJJWBS		9.90	10.90	12.30	13.20	197
N32KKC, N32KKM, N32KKW		1.60	2.30	3.40	4.80	32
N32LLMS, N32LLWS, N32MMMRS, N32MMMLS, N32MMMBS, N32MMWRS, N32MMWLS, N32MMWBS		9.70	14.80	16.30	17.00	193
N32SLLMS, N32SLLWS, N32SMMMRS, N32SMMMLS, N32SMMMBS, N32SMMWRS, N32SMMWLS, N32SMMWBS		8.60	10.50	16.70	18.20	171
N32AAMSX, N32AAWSX, N32BBMSX, N32BBWSX, N32CCMLSX, N32CCMRX, N32CCWLSX, N32CCWRSX, N32DDMRX, N32DDMLSX, N32DDWRSX, N32DDWLSX	Arm Seat Back	2.80 1.50 2.00	3.40 2.20 2.20	3.80 2.60 2.50	6.00 2.50 2.20	56 30 40
N32SAAMSX, N32SAAWSX, N32SBBMSX, N32SBBWSX, N32SCCMLSX, N32SCCMRX, N32SCCWLSX, N32SCCWRSX, N32SDDMRX, N32SDDMLSX, N32SDDWRSX, N32SDDWLSX	Arm Seat Back	3.00 1.90 1.90	3.10 1.90 2.00	3.40 2.70 2.10	4.00 3.20 2.40	60 38 38
N32HHMSX, N32HHWSX, N32JJMRX, N32JJMLSX, N32JJMBSX, N32JJWRSX, N32JJWLSX, N32JJWBSX	Arm Seat Back	2.80 4.00 3.90	3.40 4.30 4.20	3.80 4.40 5.00	6.00 4.50 5.20	56 80 78
N32SHHMSX, N32SHHWSX, N32SJJMRX, N32SJJMLSX, N32SJJMBSX, N32SJJWRSX, N32SJJWLSX, N32SJJWBSX	Arm Seat Back	3.00 4.10 3.70	3.10 4.10 3.90	3.40 5.10 4.10	4.00 6.20 5.10	60 82 74
N32LLMSX, N32LLWSX, N32MMMRSX, N32MMMLSX, N32MMMBSX, N32MMWRSX, N32MMWLSX, N32MMWBSX	Arm Seat Back	2.80 3.80 3.90	3.40 4.70 6.30	3.80 6.90 7.40	6.00 6.50 6.20	56 76 78
N32SLLMSX, N32SLLWSX, N32SMMMRSX, N32SMMMLSX, N32SMMMBSX, N32SMMWRSX, N32SMMWLSX, N32SMMWBSX	Arm Seat Back	3.00 3.70 3.70	3.10 3.80 3.80	3.40 7.50 5.80	4.00 9.20 6.40	60 74 74
N32HKM, N32HKW		3.40	4.60	5.10	7.20	68
N32LKM, N32LKW		3.20	3.70	7.00	7.20	64
N32THHW, N32MHHM, N32MHHW		6.60	7.00	8.20	7.50	132
N32MAAM, N32MAAW, N32MBBM, N32TAAW, N32MBBW		2.80	3.00	4.20	4.40	56
N32MAAMX, N32MAAWX, N32MBBMX, N32MBBWX, N32TAAWX	Seat Back	1.30 1.90	2.10 2.00	2.50 2.30	2.70 2.50	26 38
N32MHHMX, N32MHHWX, N32THHWX	Seat Back	3.10 3.60	3.50 3.90	3.70 5.30	4.20 4.50	62 72
N32MLLM, N32MLLW, N32TLLW		5.70	6.10	10.60	8.00	113.5
N32MLLMX, N32MLLWX, N32TLLWX	Seat Back	2.40 3.60	3.30 3.70	5.00 6.60	4.20 4.50	48 72

COM Yardage

COM Yardage Requirements

COM YARDAGE REQUIREMENTS (54" Width – Cut up the roll)

MODEL	Railroaded Contact customer service 800-482-1717 for ydg requirements	Non Directional Or Solid	1"-4" Repeat	5"-11" Repeat	12"-18" Repeat	COL Square Feet
			4" Vertical X 4" Horizontal	11" Vertical X 11" Horizontal	18" Vertical X 18" Horizontal	
N32STAAW, N32SMAAM, N32SMAAW, N32SMBBM, N32SMBBW		2.70	2.80	4.00	4.40	54
N32STHHW, N32SMHHM, N32SMHHW		6.40	6.80	7.80	7.50	127.5
N32STLLW, N32SMLLM, N32SMLLW		5.40	5.70	10.20	7.50	107.5
N32STAAWX, N32SMAAMX, N32SMAAWX, N32SMBBMX, N32SMBBWX	Seat Back	1.30 1.70	2.10 1.80	2.40 2.20	2.70 2.40	26 34
N32STHHWX, N32SMHHMX, N32SMHHWX	Seat Back	3.20 3.40	3.50 3.60	3.70 4.50	4.20 4.40	64 68
N32STLLWX, N32SMLLMX, N32SMLLWX	Seat Back	2.40 3.40	3.30 3.40	4.90 5.90	4.20 4.40	48 68
N35AAC		1.10	1.80	2.10	2.20	21
N35AACS		1.10	1.80	2.10	2.20	21
N35ABC		1.80	2.30	2.70	3.10	35
N35ABCS		1.80	2.30	2.70	3.10	35
N35ACC		1.10	1.80	2.10	2.20	21
N35ACCD		1.10	1.80	2.10	2.20	21
N35ACCD		1.10	1.80	2.10	2.20	21
N35ACDS		1.10	1.80	2.10	2.20	21
N35ACCS		1.10	1.80	2.10	2.20	21
N35AEC		1.80	2.30	2.70	3.10	35
N35AECD		1.80	2.30	2.70	3.10	35
N35AECD		1.80	2.30	2.70	3.10	35
N35AECS		1.80	2.30	2.70	3.10	35
N35AJC		1.10	1.80	2.10	2.20	21
N35AJCS		1.10	1.80	2.10	2.20	21
N35AMC		1.80	2.30	2.70	3.10	35
N35AMCS		1.80	2.30	2.70	3.10	35
N35AOC		1.10	1.80	2.10	2.20	21
N35AOCD		1.10	1.80	2.10	2.20	21
N35AOCD		1.10	1.80	2.10	2.20	21
N35AOCS		1.10	1.80	2.10	2.20	21
N35APC		1.80	2.30	2.70	3.10	35
N35APCD		1.80	2.30	2.70	3.10	35
N35APCD		1.80	2.30	2.70	3.10	35
N35APCS		1.80	2.30	2.70	3.10	35
N35ASC		1.10	1.80	2.10	2.20	21
N35ASCS		1.10	1.80	2.10	2.20	21
N35ATC		1.80	2.30	2.70	3.10	35
N35ATCS		1.80	2.30	2.70	3.10	35
N35BAC		1.10	1.80	2.10	2.20	21
N35BACS		1.10	1.80	2.10	2.20	21
N35BBC		1.80	2.30	2.70	3.10	35
N35BBCS		1.80	2.30	2.70	3.10	35
N35BCC		1.10	1.80	2.10	2.20	21
N35BCCD		1.10	1.80	2.10	2.20	21
N35BCCDS		1.10	1.80	2.10	2.20	21
N35BCCS		1.10	1.80	2.10	2.20	21
N35BEC		1.80	2.30	2.70	3.10	35
N35BECD		1.80	2.30	2.70	3.10	35
N35BECD		1.80	2.30	2.70	3.10	35

COM Yardage

COM Yardage Requirements

COM YARDAGE REQUIREMENTS (54" Width – Cut up the roll)

MODEL	Railroaded Contact customer service 800-482-1717 for ydg requirements	Non Directional Or Solid	1"-4" Repeat	5"-11" Repeat	12"-18" Repeat	COL Square Feet
			4" Vertical X 4" Horizontal	11" Vertical X 11" Horizontal	18" Vertical X 18" Horizontal	
N35BECS		1.80	2.30	2.70	3.10	35
N35BJC		1.10	1.80	2.10	2.20	21
N35BJCS		1.10	1.80	2.10	2.20	21
N35BMC		1.80	2.30	2.70	3.10	35
N35BMCS		1.80	2.30	2.70	3.10	35
N35BOC		1.10	1.80	2.10	2.20	21
N35BOCD		1.10	1.80	2.10	2.20	21
N35BOCDS		1.10	1.80	2.10	2.20	21
N35BOCS		1.10	1.80	2.10	2.20	21
N35BPC		1.80	2.30	2.70	3.10	35
N35BPCD		1.80	2.30	2.70	3.10	35
N35BPCDS		1.80	2.30	2.70	3.10	35
N35BPCCS		1.80	2.30	2.70	3.10	35
N35BSC		1.10	1.80	2.10	2.20	21
N35BSCS		1.10	1.80	2.10	2.20	21
N35BTC		1.80	2.30	2.70	3.10	35
N35BTCS		1.80	2.30	2.70	3.10	35
N35CAC		0.90	1.50	2.10	2.10	17
N35CBC		1.50	1.70	2.60	3.00	29
N35CCC		0.90	1.50	2.10	2.10	17
N35CCCD		0.90	1.50	2.10	2.10	17
N35CEC		1.50	1.70	2.60	3.00	29
N35CECD		1.50	1.70	2.60	3.00	29
N35CJC		0.90	1.50	2.10	2.10	17
N35CMC		1.50	1.70	2.60	3.00	29
N35COC		0.90	1.50	2.10	2.10	17
N35COCD		0.90	1.50	2.10	2.10	17
N35CPC		1.50	1.70	2.60	3.00	29
N35CPCD		1.50	1.70	2.60	3.00	29
N35CSC		0.90	1.50	2.10	2.10	17
N35CTC		1.50	1.70	2.60	3.00	29
N35EAC		0.90	1.50	2.10	2.10	17
N35EBC		1.50	1.70	2.60	3.00	29
N35ECC		0.90	1.50	2.10	2.10	17
N35ECCD		0.90	1.50	2.10	2.10	17
N35EEC		1.50	1.70	2.60	3.00	29
N35EECD		1.50	1.70	2.60	3.00	29
N35JAC		1.10	1.80	2.10	2.20	21
N35JCC		1.10	1.80	2.10	2.20	21
N35MAC		2.60	3.10	3.40	3.70	50.5
N35MBC		2.60	3.10	3.40	3.70	50.5
39A-GWXX, 39A-GWXXT						
39A-GRXX		1.10	1.30	2.30	2.40	22
39A-GWXXX, 39A-GWXXTX	Seat	0.80	0.90	1.20	1.00	7
39A-GRXXX	Back	0.60	0.80	1.40	1.40	12
39A-TAA, 39A-TAAT		1.80	2.10	3.80	4.40	36
39A-TAAX, 39A-TAATX	Seat	0.80	1.60	2.10	2.10	16
	Back	1.10	1.40	2.00	2.40	22
39A-TAAA, 39A-TAAAT		2.70	3.30	5.90	6.40	54
39A-TAAAX, 39A-TAAATX	Seat	1.50	2.20	3.00	3.10	30
	Back	1.60	1.90	3.20	3.40	32
39A-BWAA, 39A-BWAAT		1.90	2.10	2.30	2.50	38

COM Yardage Requirements

COM YARDAGE REQUIREMENTS (54" Width – Cut up the roll)

MODEL	Railroaded Contact customer service 800-482-1717 for ydg requirements	Non Directional Or Solid	1"-4" Repeat	5"-11" Repeat	12"-18" Repeat	COL Square Feet
			4" Vertical X 4" Horizontal	11" Vertical X 11" Horizontal	18" Vertical X 18" Horizontal	
39A-BWAAX, 39A-BWAATX	Seat	0.90	1.00	1.20	1.10	18
	Back	1.10	1.30	1.40	1.40	22
39H-GWXX, 39H-GWXT		0.80	1.50	1.40	2.00	14
39H-GWXXX, 39H-GWXTX	Seat	0.80	0.90	1.20	1.10	7
	Back	0.70	0.90	0.80	1.00	14
39B-GWXX, 39B-GWXT						
39S-GWXX, 39S-GWXT						
39L-GWXX, 39L-GWXT						
39D-GWXX, 39D-GWXT						
39B-GRXX, 39L-GRXX						
39S-GRXX, 39D-GRXX		0.80	0.90	1.20	1.10	7
39U-GWXX, 39U-GWXT		1.30	1.50	2.40	3.00	23
39U-GWXXX, 39U-GWXTX	Seat	0.80	0.90	1.20	1.10	7
	Back	0.70	0.90	1.40	2.00	14
39U-GRXX		1.30	1.50	1.50	3.00	23
39E-GRXXX	Seat	0.80	0.90	1.10	1.10	7
	Back	0.70	0.90	0.80	2.00	14
39E-GWXX, 39E-GWXT						
39E-GRXX		1.30	1.50	1.40	2.00	23
39E-GWXXX, 39E-GWXTX	Seat	0.80	0.90	1.20	1.10	7
	Back	0.70	0.90	0.80	1.00	14
N45AUR (Set of 1)		0.70	0.80	0.80	0.90	5
N45AU (Set of 4)		1.30	1.50	1.40	4.00	24.5
N45BUR (Set of 1)		0.70	0.80	0.80	0.90	5
N45BU (Set of 4)		1.30	1.50	1.40	4.00	24.5
N45CU, N45HU, N45HUL, N45JU, N45JUL, N45U1		0.70	0.80	0.80	0.90	5
N45U2		0.80	0.80	1.00	1.90	13
N45U3		1.30	1.30	1.60	2.90	24
48-EK, 48-EKN		2.90	3.10	3.90	3.90	59
48-ES, 48-ESN		2.90	3.10	3.90	3.90	59
48-GC, 48-GCN		2.90	3.10	3.90	3.90	59
N48GFA, N48GFM		1.70	1.70	2.90	3.00	31.5
N48GFAX, N48GFMX	Back	0.90	0.90	1.00	1.30	8
	Extreme	0.80	0.90	0.90	0.80	6.5
	Seat	1.10	1.10	1.20	1.10	19
N52GHA, N52GHAC, N52GHM, N52GHMC		0.80	0.80	1.10	1.00	14
N55AA, N55BB		1.20	1.50	2.30	2.90	23
N55CC, N55DD		0.80	1.00	1.10	1.10	10
N55EE, N55HH		0.80	1.20	1.70	1.80	15
N55AAX N55BBX	Back	0.70	0.70	0.70	0.90	6.5
	Extreme	0.70	0.70	0.70	0.90	6.0
	Seat	0.80	0.80	1.00	1.10	7.5
N55EEX	Back	0.50	0.50	0.60	0.80	4.5
N55HHX	Extreme	0.40	0.50	0.60	0.80	3.5
	Seat	0.80	0.80	1.00	1.10	7.5
N59AA, N59AAT, N59AL		0.90	1.40	1.60	2.40	18
N59BB, N59BBT, N59BL		1.20	1.60	1.90	3.40	24
N59CC, N59CCT, N59CL		0.90	1.10	1.20	1.10	18
N59DD, N59DDT, N59DL		0.90	1.30	1.50	1.90	18
N59HH, N59HHT, N59HL		0.90	1.40	1.60	2.40	18
N59JJ, N59JJT, N59JL		1.10	1.60	1.80	2.90	22
N59KK, N59KKT		0.90	1.00	1.20	1.50	18
N59MM, N59MMT		1.50	1.60	2.10	2.30	30
N59PP, N59PPT		1.40	1.50	1.70	2.20	28

COM Yardage Requirements

COM YARDAGE REQUIREMENTS (54" Width – Cut up the roll)

MODEL	Railroaded Contact customer service 800-482-1717 for ydg requirements	Non Directional Or Solid	1"-4" Repeat	5"-11" Repeat	12"-18" Repeat	COL Square Feet
			4" Vertical X 4" Horizontal	11" Vertical X 11" Horizontal	18" Vertical X 18" Horizontal	
N59AAX	Back	0.40	0.60	0.70	0.90	2.6
N59AATX	Extreme	0.40	0.60	0.70	0.90	2.6
N59ALX	Seat	0.90	1.10	1.20	1.10	18
N59BBX	Back	0.40	0.60	0.70	0.90	2.6
N59BBTX	Lumbar	0.40	0.60	0.70	0.90	2.6
N59BLX	Extreme Back	0.40	0.60	0.70	0.90	2.6
	Extreme Lumbar	0.40	0.60	0.70	0.90	2.6
	Seat	0.90	1.10	1.20	1.10	18
N59DDX	Back	0.40	0.60	0.70	0.90	2.6
N59DDTX	Extreme Back	0.30	0.40	0.60	0.80	1.5
N59DLX	Seat	0.90	1.10	1.20	1.10	18
N59HHX	Lumbar	0.40	0.60	0.70	0.90	2.6
N59HHTX	Extreme Lumbar	0.40	0.60	0.70	0.90	2.6
N59HLX	Seat	0.90	1.10	1.20	1.10	18
N59JJX	Back	0.40	0.60	0.70	0.90	2.6
N59JJTX	Lumbar	0.40	0.60	0.70	0.90	2.6
N59JLX	Extreme Back	0.30	0.40	0.60	0.80	1.5
	Extreme Lumbar	0.40	0.60	0.70	0.90	2.6
	Seat	0.90	1.10	1.20	1.10	18
N59MMX	Back	0.40	0.50	0.60	0.90	4
N59MMTX	Extreme Back	0.40	0.50	0.60	0.90	4
	Seat	0.90	1.00	1.10	1.40	18
N59PPX	Back	0.40	0.50	0.60	0.90	4
N59PPTX	Extreme Back	0.20	0.30	0.50	0.70	2.5
	Seat	0.90	1.00	1.10	1.40	18
N60AA, N60SAA, N60BB, N60SBB, N60CC, N60SCC, N60DD, N60SDD, N60SAAC, N60SBBC, N60SCCC, N60SDDC, N60SFA, N60SFB, N60SFC, N60SFD, N60STA, N60STB, N60STC, N60STD		0.90	1.00	1.40	2.30	18
N60AAX, N60SAAX, N60BBX, N60SBBX, N60SAACX, N60SBBXC, N60SFAX, N60SFBX, N60STAX, N60STBX	Back Seat	0.50 0.90	0.60 0.90	0.70 1.10	1.30 1.00	10 7
N60AW, N60BW, N60CW, N60DW, N60SAW, N60SBW, N60SAWC, N60SBWC, N60SFAW, N60SFBW, N60STAW, N60STBW, N60STCW, N60STDW, N60SCW, N60SDW, N60SCWC, N60SDWC, N60SFCW, N60SFDW		0.90	0.90	1.10	1.00	7
N60CCX, N60SCCX, N60DDX, N60SDDX, N60SCCCX, N60SDDCX, N60SFCX, N60SFDX, N60STCX, N60STDX	Back Seat	0.60 0.90	0.60 0.90	0.70 1.10	1.30 1.00	12 7
N60EM, N60SEM		1.20	1.60	1.90	1.90	22
N60EMX, N60SEM X	Back Seat	0.60 0.80	0.90 0.90	1.00 1.10	1.40 1.00	9 14
N60EMW, N60GMW, N60SEM W, N60SGMW		0.80	0.90	1.10	1.00	14
N60EE, N60SEE, N60GG, N60SGG		1.60	1.80	2.10	2.30	30.5
N60EEX, N60SEEX N60GGX, N60SGGX	Back Seat	0.80 0.90	0.90 1.00	1.10 1.20	1.00 1.30	14 17
N60EW, N60SEEW, N60GW, N60SGGW		0.80	0.90	1.10	1.00	14
N60GM, N60SGM		1.20	1.70	2.20	1.90	22
N60GMX, N60SGMX	Back Seat	0.60 0.80	0.90 0.90	1.30 1.10	1.40 1.00	9 14

COM Yardage

COM Yardage Requirements

COM YARDAGE REQUIREMENTS (54" Width – Cut up the roll)

MODEL	Railroaded Contact customer service 800-482-1717 for ydg requirements	Non Directional Or Solid	1"-4" Repeat	5"-11" Repeat	12"-18" Repeat	COL Square Feet
			4" Vertical X 4" Horizontal	11" Vertical X 11" Horizontal	18" Vertical X 18" Horizontal	
62X-AUXX		9.00	15.00	16.20	20.50	183
62X-GUXX		2.15	2.81	5.00	6.03	44
62X-LUXX		6.60	10.30	11.30	15.00	134
62X-UUXX		5.00	7.20	8.30	12.00	102
64X-GWXX		1.36	1.58	2.97	2.97	28
N65AAA		1.90	2.80	3.10	4.10	37
N65AAP		1.90	2.80	3.10	4.10	37
N65AASA		1.90	2.80	3.10	4.10	37
N65AASP		1.90	2.80	3.10	4.10	37
N65BBA		1.80	2.40	3.00	3.40	36
N65BBP		1.80	2.40	3.00	3.40	36
N65BBSA		1.80	2.40	3.00	3.40	36
N65BBSP		1.80	2.40	3.00	3.40	36
N65CCA		1.90	2.80	3.10	4.10	37
N65CCP		1.90	2.80	3.10	4.10	37
N65CCSA		1.90	2.80	3.10	4.10	37
N65CCSP		1.90	2.80	3.10	4.10	37
N65DDA		1.80	2.40	3.00	3.40	36
N65DDP		1.80	2.40	3.00	3.40	36
N65DDSA		1.80	2.40	3.00	3.40	36
N65DDSP		1.80	2.40	3.00	3.40	36
N65EEA		1.00	1.50	2.00	2.40	19
N65EEP		1.00	1.50	2.00	2.40	19
N65GGA		1.00	1.10	1.30	1.20	11
N65GGP		1.00	1.10	1.30	1.20	11
N65HHA		1.00	1.10	1.30	1.20	11
N65HHP		1.00	1.10	1.30	1.20	11
N66RD16G, N66RD16C		1.10	1.30	1.90	2.30	22
N66RD18C, N66RD18G		1.20	1.40	1.30	3.90	24
N66RD18CX, N66RD18GX	Seat Upholstery	0.60 1.20	0.70 1.40	0.70 1.30	0.90 2.90	6.5 24
N66RD22C, N66RD22G		1.30	2.20	2.60	3.90	26
N66RD22CX, N66RD22GX	Seat Upholstery	0.80 1.20	0.80 2.20	1.00 1.90	0.90 2.90	8.5 24
N66SQ16G, N66SQ16C		1.10	1.90	2.40	2.70	22
N66SQ18C, N66SQ18G		1.80	1.90	1.90	4.90	36
N66SQ18CX, N66SQ18GX	Seat Upholstery	0.60 1.20	0.70 1.40	0.70 1.30	0.90 3.90	6.5 24
N66SQ22C, N66SQ22G		1.90	2.10	1.90	4.90	0.8
N66SQ22CX, N66SQ22GX	Seat Upholstery	0.70 1.20	0.70 1.40	1.00 1.30	0.90 3.90	7 24
N66TZ16G, N66TZ16C		1.00	1.30	1.90	2.30	20
N66TZ18G, N66TZ18C		1.10	1.60	2.20	3.40	22
N66TZ22G, N66TZ22C		1.40	1.90	2.20	3.90	28
N66RD16GX, N66RD16CX	Seat Upholstery	0.60 1.10	0.80 1.30	0.90 1.90	1.30 2.30	12 22
N66SQ16GX, N66SQ16CX	Seat Upholstery	0.60 1.10	0.80 1.30	0.90 1.90	1.30 2.30	12 22
N66TZ16GX, N66TZ16CX	Seat Upholstery	0.50 1.00	0.60 1.30	0.90 1.60	1.30 1.80	10 20
N66TZ18GX, N66TZ18CX	Seat Upholstery	0.60 1.10	0.80 1.40	0.90 1.60	1.30 3.30	12 22
N66TZ22GX, N66TZ22CX	Seat Upholstery	0.60 1.10	0.80 1.40	1.00 1.60	1.40 3.40	12 22

COM Yardage Requirements

COM YARDAGE REQUIREMENTS (54" Width – Cut up the roll)

MODEL	Railroaded Contact customer service 800-482-1717 for ydg requirements	Non Directional Or Solid	1"-4" Repeat	5"-11" Repeat	12"-18" Repeat	COL Square Feet
			4" Vertical X 4" Horizontal	11" Vertical X 11" Horizontal	18" Vertical X 18" Horizontal	
N67AAC, N67BBC		3.70	4.70	5.20	5.90	74
N67CCC, N67DDC		3.40	4.10	4.90	5.90	69
N67EE		2.60	3.80	4.80	5.00	53
N68AAC, N68BBC		3.60	4.70	5.50	5.90	73
N68CCC, N68DDC		3.10	3.60	4.80	6.10	63
N68EE		2.80	3.80	5.10	5.10	55
N69AAC, N69BBC		3.50	4.30	4.90	5.90	71
N69CCC, N69DDC		3.20	3.40	4.70	5.90	63
N69EE		2.70	3.30	3.90	4.70	53
72X-GUXT, 72-GUXX		1.20	1.70	1.80	2.20	25
N75BAC		2.30	3.10	3.50	5.40	47
N75BBC		2.30	3.10	3.50	5.40	47
N75BCC		2.20	2.60	3.00	5.00	45
N75BDC		2.20	2.60	3.00	5.00	45
N75SAC		2.30	3.10	3.50	5.40	47
N75SBC		2.30	3.10	3.50	5.40	47
N75SCC		2.20	2.60	3.00	5.00	45
N75SDC		2.20	2.60	3.00	5.00	45
N75SPC		2.20	2.60	3.00	5.00	45
N75SSC		2.30	3.10	3.50	5.40	47
N75WS		1.30	1.50	2.20	2.90	26
N78PAU		1.80	2.20	2.90	3.00	35.5
N78GEAU		2.10	2.30	3.50	3.90	41.5
N78GEAW		1.90	2.00	3.20	3.50	36.5
N78GFAU, N78GFMU, N78SFAU, N78SFMU, N78AFLAU, N78AFRAU, N78AFLMU, N78AFRMU		1.50	1.70	2.60	2.90	30
N78T2AU, N78B2AU, N78B2EU		2.80	3.40	4.10	5.90	55
N78T3AU, N78B3AU, N78B3EU		4.10	5.10	6.50	8.90	80
N78GFAW, N78GFMW, N78SFAW, N78SFMW, N78AFLAW, N78AFRAW, N78AFLMW, N78AFRMW		1.40	1.50	2.20	2.90	26.5
N78T2AW, N78B2AW, N78B2EW		2.40	2.80	3.70	5.40	46.5
N78T3AW, N78B3AW, N78B3EW		3.70	4.30	5.60	7.90	72
N78D1M		1.10	1.20	1.30	1.70	21.5
N78D2M, N78D2A		1.80	1.90	2.20	3.20	34
N78D3M, N78D3A		2.20	2.30	2.90	4.70	43
N78PAUX	Back	1.00	1.20	1.20	1.10	20
	Extreme	1.00	1.10	1.20	1.10	19.5
	Seat	0.90	1.00	1.10	1.30	17
N78GEAUX	Back	0.80	0.80	1.40	1.40	14.5
	Extreme	0.70	0.80	0.80	0.90	12.75
	Seat	1.00	1.10	2.10	1.90	20
N78GEAWX	Back	0.60	0.70	1.20	1.30	12
	Extreme	0.60	0.70	0.70	0.90	10.5
	Seat	1.00	1.10	2.10	1.90	20

COM Yardage

COM Yardage Requirements

COM YARDAGE REQUIREMENTS (54" Width – Cut up the roll)

MODEL	Railroaded Contact customer service 800-482-1717 for ydg requirements	Non Directional Or Solid	1"-4" Repeat	5"-11" Repeat	12"-18" Repeat	COL Square Feet
			4" Vertical X 4" Horizontal	11" Vertical X 11" Horizontal	18" Vertical X 18" Horizontal	
N78GFAUX, N78GFMUX, N78SFAUX, N78SFMUX, N78AFLAUX, N78AFRAUX, N78AFLMUX, N78AFRMUX	Back Extreme Seat	0.80 0.70 0.90	0.90 0.80 1.00	1.10 0.70 1.10	1.00 0.90 1.30	14.5 7 17
N78T2AUX, N78B2AUX, N78B2EUX	Back Extreme Seat	1.30 0.70 1.60	1.50 1.40 1.80	1.40 1.30 2.00	2.00 1.90 2.30	25 12 31
N78T3AUX, N78B32AUX, N78B32EUX	Back Extreme Seat	1.50 1.30 2.40	1.80 2.10 2.50	2.30 2.00 3.00	3.00 2.90 3.30	28 24.5 47
N78GFAWX, N78GFMWX, N78SFAWX, N78SFMWX, N78AFLAWX, N78AFRAWX, N78AFLMWX, N78AFRMWX	Back Extreme Seat	0.60 0.60 0.90	0.70 0.70 1.00	0.70 0.70 1.10	0.90 0.90 1.30	12 5 17
N78T2AWX, N78B2AWX, N78B2EWX	Back Extreme Seat	0.90 0.60 1.60	1.20 1.30 1.80	1.30 1.30 2.00	1.30 1.40 2.30	18 10.5 31
N78T3AWX, N78B3AWX, N78B3EWX	Back Extreme Seat	1.20 1.10 2.40	1.30 1.80 2.50	1.90 1.90 3.00	2.90 1.90 3.30	22 20.5 47
N78LAAAU, N78LAAAUB, N78LAAAUR, N78LAAAUL		7.60	9.10	14.80	18.40	150
N78LAAAUX, N78LAAAUBX, N78LAAAURX, N78LAAAULX	Back Arm Extreme Back	1.90 2.90 1.70	2.60 3.20 2.70	3.00 5.00 3.00	3.10 7.90 3.00	35.5 56 33
N78LAAAW, N78LAAAWR, N78LAAAWL, N78LAAAWB		7.70	9.10	14.40	18.40	151
N78LAAAWX, N78LAAAWRX, N78LAAAWLX, N78LAAAWBX	Seat Front Back Arm Extreme Back	2.80 1.60 2.90 1.50	3.80 1.80 3.20 2.50	3.70 2.90 5.00 2.90	7.80 3.00 7.90 3.00	54 30.5 56 28.5
N78LAAU, N78LAAUR N78LAAUL, N78LAAUB		5.40	6.40	10.20	12.90	105
N78LAAUX, N78LAAURX, N78LAAULX, N78LAAUBX	Seat Back Arm Extreme Back	1.90 1.70 2.40 0.90	2.60 1.80 2.60 1.90	2.50 2.10 3.30 2.10	5.30 2.10 5.90 2.00	40 32 45 17
N78LAAW, N78LAAWR N78LAAWL, N78LAAWB		5.10	6.10	10.20	12.90	100
N78LAAWX, N78LAAWRX N78LAAWLX, N78LAAWBX	Seat Front Back Arm Extreme Back	1.90 1.50 2.40 0.80	2.60 1.70 2.60 1.70	2.50 2.00 3.30 2.00	7.30 2.00 5.90 2.00	40 28 45 14.5
N78LAU, N78LAUR, N78LAUL		3.20	3.70	5.90	7.40	61
N78LAUX, N78LAURX, N78LAULX	Seat Back Arm Extreme Back	1.30 1.00 1.80 0.90	1.30 1.00 1.80 1.00	1.30 1.20 2.80 1.10	2.80 1.10 3.90 1.00	23.5 18.5 34 8
N78LAW, N78LAWR, N78LAWL		3.00	3.70	5.90	7.40	57.5
N78LAWX, N78LAWRX, N78LAWLX	Seat Front Back Arm Extreme Back	1.30 0.90 1.80 0.80	1.30 0.90 1.80 0.90	1.30 1.10 2.80 1.10	2.80 1.00 3.90 1.00	23.5 15.5 34 8
N78LBU, N78LBUR, N78LBUL, N78LBUB		4.70	5.90	8.90	11.30	92

COM Yardage Requirements

COM YARDAGE REQUIREMENTS (54" Width – Cut up the roll)

MODEL	Railroaded Contact customer service 800-482-1717 for ydg requirements	Non Directional Or Solid	1"-4" Repeat	5"-11" Repeat	12"-18" Repeat	COL Square Feet
			4" Vertical X 4" Horizontal	11" Vertical X 11" Horizontal	18" Vertical X 18" Horizontal	
N78LBUX, N78LBURX, N78LBULX, N78LBUBX	Seat	1.90	2.60	2.50	5.30	40
	Back	1.70	1.80	2.10	2.10	32
	Arm	1.80	1.80	2.80	3.90	34
	Extreme Back	0.90	1.90	2.10	2.00	17
N78LBW, N78LBWR, N78LBWL, N78LBWB		4.40	5.50	8.70	11.30	87
N78LBWX, N78LBWRX, N78LBWLX, N78LBWBX	Seat	1.90	2.60	2.50	5.30	40
	Front Back	1.50	1.70	2.00	2.00	28
	Arm	1.80	1.80	2.80	3.90	34
	Extreme Back	0.80	1.70	2.00	2.00	14.5
N78LCU, N78LCUR, N78LCUL, N78LCUB		6.40	7.60	12.00	15.80	126
N78LCUX, N78LCURX, N78LCULX, N78LCUBX	Seat	2.80	3.80	3.70	7.80	54
	Back	1.90	2.60	3.00	3.10	35.5
	Arm	1.80	1.80	2.80	3.90	34
	Extreme Back	1.70	2.70	3.00	3.00	33
N78LCW, N78LCWR, N78LCWL, N78LCWB		6.10	7.30	12.00	15.80	118.5
N78LCWX, N78LCWRX, N78LCWLX, N78LCWBX	Seat	2.80	3.80	3.70	7.80	54
	Front Back	1.60	1.80	2.90	3.00	30.5
	Arm	1.80	1.80	2.80	3.90	34
	Extreme Back	1.50	2.50	2.90	3.00	28.5
N78LEU		4.10	4.80	5.90	7.40	78.5
N78LEUX	Seat	1.30	1.70	1.80	2.80	24
	Back	1.00	1.00	1.20	1.50	18.5
	Arm	1.80	1.80	2.80	3.90	34
	Extreme Back	0.90	1.00	1.10	1.00	17
N78LEW		3.80	4.50	5.90	7.40	74
N78LEWX	Seat	1.30	1.70	1.80	2.80	24
	Front Back	0.90	0.90	1.10	1.40	15.5
	Arm	1.80	1.80	2.80	3.90	34
	Extreme Back	0.80	0.90	1.10	1.00	14.5
N79AAC		1.90	2.90	3.00	3.00	38
N79BBC, N79CC		1.70	1.90	3.00	3.00	33
N85CAC		1.70	2.40	3.00	3.00	35
N85CBC		1.60	2.30	2.70	3.00	34
N85LA, N85LAT		2.80	4.90	5.80	7.00	56
N85LAX, N85LATX	Back	0.90	1.00	1.20	1.10	18
N85LAX, N85LATX	Seat	1.10	1.20	1.80	2.30	22
N85LAX, N85LATX	Outer Shell	1.90	3.10	3.90	5.00	38
N85LB, N85LBT		4.00	7.60	8.90	10.80	80
N85LBX, N85LBTX	Back	1.00	2.00	2.20	2.10	20
N85LBX, N85LBTX	Seat	1.30	2.20	2.80	3.30	26
N85LBX, N85LBTX	Outer Shell	2.10	3.80	4.80	6.00	42
N85LC, N85LCT		5.30	10.40	11.30	13.80	106
N85LCX, N85LCTX	Back	1.80	2.90	3.10	3.20	36
N85LCX, N85LCTX	Seat	1.90	3.50	3.10	4.80	38
N85LCX, N85LCTX	Outer Shell	2.70	4.60	5.70	7.00	54
N85LD, N85LDT		2.60	4.40	6.40	6.30	52
N85LDX, N85LDTX	Seat	1.70	3.40	4.00	4.30	34
N85LDX, N85LDTX	Outer Shell	1.10	1.30	2.60	2.40	22
N85SA, N85SAT		0.90	1.50	2.30	2.40	18
N85SAA, N85SAAT		1.80	2.90	4.10	4.40	36
N85SAAA, N85SAAAT		2.50	4.10	5.90	6.40	50
N85SAAAX, N85SAAATX	Back	1.30	1.50	3.20	3.40	26
N85SAAAX, N85SAAATX	Seat	2.50	2.80	3.10	3.10	50

COM Yardage Requirements

COM YARDAGE REQUIREMENTS (54" Width – Cut up the roll)

MODEL	Railroaded Contact customer service 800-482-1717 for ydg requirements	Non Directional Or Solid	1"-4" Repeat	5"-11" Repeat	12"-18" Repeat	COL Square Feet
			4" Vertical X 4" Horizontal	11" Vertical X 11" Horizontal	18" Vertical X 18" Horizontal	
N85SAAX, N85SAATX	Back	0.90	1.10	2.20	2.40	18
N85SAAX, N85SAATX	Seat	1.70	1.90	2.20	2.10	34
N85SACA, N85SACAT		2.50	3.80	5.30	5.40	50
N85SACAX, N85SACATX	Back	0.90	1.10	2.30	2.40	18
N85SACAX, N85SACATX	Seat	2.50	2.80	3.10	3.10	50
N85SAX, N85SATX	Back	0.50	0.70	1.30	1.40	10
N85SAX, N85SATX	Seat	0.90	1.10	1.20	1.10	18
N85SB, N85SBT		1.20	1.60	2.60	3.00	24
N85SBX, N85SBTX	Back	0.60	0.80	1.40	2.00	12
N85SBX, N85SBTX	Seat	0.90	1.10	1.20	1.10	18
N85SC, N85SCT		0.80	1.00	1.10	1.00	17
N85SE, N85SET		2.00	2.20	2.60	3.00	40
N85SEX, N85SETX	Back	1.20	1.40	1.40	2.00	24
N85SEX, N85SETX	Seat	0.90	1.10	1.20	1.10	18
88X-GMXX		1.50	2.30	2.60	2.90	31
88X-GRXX		1.50	2.30	2.60	2.90	31
88X-MNFXC, 88X-MNFXCJ, 88X-MRFXC, 88X-MRFXCJ		1.50	2.50	2.90	3.00	31
88X-ENFXC, 88X-ENFXCJ		1.70	2.80	2.90	3.00	35
89X-EWEXC		1.80	2.70	3.00	3.00	37
89X-MWEXC		1.60	2.40	2.90	2.90	33
89X-EUEXC, 89X-EUFXC		2.15	2.70	3.00	3.80	44
89X-MUEXC, 89X-MUFXC		2.00	2.40	2.90	3.30	41
89X-EWECC		1.80	2.70	3.00	3.80	37
89X-MWECC		1.60	2.40	2.90	3.30	33
89X-GWXX		1.50	2.30	2.60	2.90	31
N90AA		4.80	7.10	8.50	8.90	106
N90BB		8.30	10.80	12.30	13.40	184
N90CC		9.10	15.00	16.50	17.40	203
N90AAP	Upholstery	4.80	7.10	8.50	8.90	106
N90AAX	Seat/Back	1.40	2.40	3.60	3.70	32
N90AAX	Outer Shell	4.00	4.60	5.10	6.50	90
N90BBP	Upholstery	8.30	10.80	12.30	13.40	184
N90BBX	Seat/Back	3.30	5.10	5.70	5.70	74
N90BBX	Outer Shell	5.30	5.90	7.40	7.90	119
N90CCP	Upholstery	9.10	15.00	16.50	17.40	203
N90CCX	Seat/Back	4.90	7.60	8.50	8.50	110
N90CCX	Outer Shell	6.10	7.90	8.00	9.40	136
N92B1		2.70	3.10	3.70	3.30	52.5
N92B2		4.40	5.00	5.80	5.40	86.5
N92B3		6.10	6.90	8.00	7.40	119.5
N92B9		2.90	3.30	4.90	5.60	57.5
N92CSA, N92CSAC, N92CSAL, N92CSACL, N92CSAR, N92CSACR		3.50	4.60	6.10	7.80	70
N92CSAX, N92CSACX, N92CSALX, N92CSACLX, N92CSARX, N92CSACRX	Upholstery Arm	2.40 2.00	3.00 2.20	3.50 2.50	3.80 3.90	48 40
N92CSLL, N92CSLLC, N92CSRR, N92CSRRC		2.80	3.40	5.20	5.90	56
N92CSLLX, N92CSLLCX, N92CSRRX, N92CSRRCX	Upholstery Arm	2.40 0.90	3.00 1.10	3.50 1.90	3.80 1.90	48 18
N92CSM, N92CSMC		2.40	3.00	3.50	3.80	48

COM Yardage Requirements

COM YARDAGE REQUIREMENTS (54" Width – Cut up the roll)

MODEL	Railroaded Contact customer service 800-482-1717 for ydg requirements	Non Directional Or Solid	1"-4" Repeat	5"-11" Repeat	12"-18" Repeat	COL Square Feet
			4" Vertical X 4" Horizontal	11" Vertical X 11" Horizontal	18" Vertical X 18" Horizontal	
N92H1B, N92H1BR, N92H1BL		7.70	8.30	9.30	10.40	151
N92H1BH		10.60	11.30	12.50	12.90	211
N92H1BHX	Seat	2.60	3.00	3.10	3.90	50
	Back	1.40	1.50	1.50	2.20	25
	Lumbar	0.40	0.50	0.60	0.80	7
	Accent	1.00	1.10	1.20	1.30	18
	Arms	5.70	5.90	7.50	7.50	113
N92H1BM		9.20	9.90	11.30	12.20	183
N92H1BMX	Seat	2.60	3.00	3.10	3.90	50
	Back	1.40	1.50	1.50	2.20	25
	Lumbar	0.40	0.50	0.60	0.80	7
	Accent	1.00	1.10	1.20	1.30	18
	Arms	4.30	4.60	6.30	7.10	86
N92H1BX, N92H1BRX, N92H1BLX	Seat	2.60	3.00	3.10	3.90	50
	Back	1.40	1.50	1.50	2.20	25
	Lumbar	0.40	0.50	0.60	0.80	7
	Accent	1.00	1.10	1.20	1.30	18
	Arms	2.80	3.20	3.80	3.90	58
N92H1M		5.00	5.70	6.10	6.40	97
N92H1MX	Seat	2.60	3.00	3.10	3.90	50
	Back	1.40	1.50	1.50	2.20	25
	Lumbar	0.40	0.50	0.60	0.80	7
	Accent	1.00	1.10	1.20	1.30	18
N92H1R, N92H1RR, N92H1L, N92H1LL		6.30	6.90	7.40	8.40	124
N92H1RH, N92H1LH		7.80	8.40	9.40	9.90	155.5
N92H1RHX, N92H1LHX	Seat	2.60	3.00	3.10	3.90	50
	Back	1.40	1.50	1.50	2.20	25
	Lumbar	0.40	0.50	0.60	0.80	7
	Accent	1.00	1.10	1.20	1.30	18
	Arms	2.90	3.10	4.40	4.50	57.5
N92H1RM, N92H1LM		7.10	7.80	8.80	9.20	142
N92H1RMX, N92H1LMX	Seat	2.60	3.00	3.10	3.90	50
	Back	1.40	1.50	1.50	2.20	25
	Lumbar	0.40	0.50	0.60	0.80	7
	Accent	1.00	1.10	1.20	1.30	18
	Arms	2.20	2.40	3.70	4.10	44
N92H1RX, N92H1RRX, N92H1LX, N92H1LLX	Seat	2.60	3.00	3.10	3.90	50
	Back	1.40	1.50	1.50	2.20	25
	Lumbar	0.40	0.50	0.60	0.80	7
	Accent	1.00	1.10	1.20	1.30	18
	Arms	1.50	1.60	1.90	1.90	30
N92H2B, N92H2BR, N92H2BL, N92H2BB, N92HTU2B, N92HTU2BR, N92HTU2BL, N92HTU2BB		11.50	12.50	13.70	14.90	229
N92H2BH, N92HTU2BH		14.50	15.40	17.40	19.80	289
N92H2BHX, N92HTU2BHX	Seat	4.10	4.60	4.90	5.30	80
	Back	2.50	2.60	2.60	3.90	50
	Lumbar	0.70	0.80	0.90	1.30	13
	Accent	1.90	2.00	2.50	2.30	35.5
	Arms	5.70	5.90	7.50	7.50	113
N92H2BM, N92HTU2BM		13.10	13.90	16.10	18.80	261
N92H2BMX, N92HTU2BMX	Seat	4.10	4.60	4.90	5.30	80
	Back	2.50	2.60	2.60	3.90	50
	Lumbar	0.70	0.80	0.90	1.30	13
	Accent	1.90	2.00	2.50	2.30	35.5
	Arms	4.30	4.60	6.30	7.10	86

COM Yardage Requirements

COM YARDAGE REQUIREMENTS (54" Width – Cut up the roll)

MODEL	Railroaded Contact customer service 800-482-1717 for ydg requirements	Non Directional Or Solid	1"-4" Repeat	5"-11" Repeat	12"-18" Repeat	COL Square Feet
			4" Vertical X 4" Horizontal	11" Vertical X 11" Horizontal	18" Vertical X 18" Horizontal	
N92H2BX, N92H2BRX, N92H2BLX, N92H2BBX, N92HTU2BX, N92HTU2BRX, N92HTU2BLX, N92HTU2BBX	Seat	4.10	4.60	4.90	5.30	80
	Back	2.50	2.60	2.60	3.90	50
	Lumbar	0.70	0.80	0.90	1.30	13
	Accent	1.90	2.10	2.50	2.30	35.5
	Arms	2.80	3.20	3.80	3.90	58
N92H2M, N92HTU2M		8.90	9.70	11.00	10.90	177
N92H2MX, N92MTU2MX	Seat	4.10	4.60	4.90	5.30	80
	Back	2.50	2.60	2.60	3.90	50
	Lumbar	0.70	0.80	0.90	1.30	13
	Accent	1.90	2.10	2.50	2.30	35.5
N92H2R, N92H2RR, N92H2L, N92H2LL, N92HTU2R, N92HTU2RR, N92HTU2L, N92HTU2LL		10.20	11.10	12.20	12.90	203
N92H2RH, N92H2LH, N92HTU2RH, N92HTU2LH		11.70	12.60	14.30	15.90	233
N92H2RHX, N92H2LHX, N92HTU2RHX, N92HTU2LHX	Seat	4.10	4.60	4.90	5.30	80
	Back	2.50	2.60	2.60	3.90	50
	Lumbar	0.70	0.80	0.90	1.30	13
	Accent	1.90	2.00	2.50	2.30	35.5
	Arms	2.90	3.10	4.40	4.50	57.5
N92H2RM, N92H2LM, N92HTU2RM, N92HTU2LM		11.00	11.70	13.70	15.80	219
N92H2RMX, N92H2LMX, N92HTU2RMX, N92HTU2LMX	Seat	4.10	4.60	4.90	5.30	80
	Back	2.50	2.60	2.60	3.90	50
	Lumbar	0.70	0.80	0.90	1.30	13
	Accent	1.90	2.00	2.50	2.30	35.5
	Arms	2.20	2.40	3.70	4.10	44
N92H2RX, N92H2RRX, N92H2LX, N92H2LLX, N92HTU2RX, N92HTU2RRX, N92HTU2LX, N92HTU2LLX	Seat	4.10	4.60	4.90	5.30	80
	Back	2.50	2.60	2.60	3.90	50
	Lumbar	0.70	0.80	0.90	1.30	13
	Accent	1.90	2.10	2.50	2.30	35.5
	Arms	1.50	1.60	1.90	1.90	30
N92H3B, N92H3BR, N92H3BL, N92H3BB, N92HTU3B, N92HTU3BR, N92HTU3BL, N92HTU3BB		15.50	16.90	18.50	18.90	307
N92H3BH, N92HTU3BH		18.40	19.40	22.30	21.20	366
N92H3BHX, N92HTU3BHX	Seat	5.60	6.30	6.70	7.30	111.5
	Back	3.70	3.80	3.80	5.90	74
	Lumbar	1.10	1.20	1.20	1.80	22
	Accent	2.80	3.10	3.70	3.30	56
	Arms	5.70	5.90	7.50	7.50	113
N92H3BM, N92HTU3BM		17.00	17.90	21.10	21.20	339
N92H3BMX, N92HTU3BMX	Seat	5.60	6.30	6.70	7.30	111.5
	Back	3.70	3.80	3.80	5.90	74
	Lumbar	1.10	1.20	1.20	1.80	22
	Accent	2.80	3.10	3.70	3.30	56
	Arms	4.30	4.60	6.30	7.10	86
N92H3BX, N92H3BRX, N92H3BLX, N92H3BBX, N92HTU3BX, N92HTU3BRX, N92HTU3BLX, N92HTU3BBX	Seat	5.60	6.30	6.70	7.30	111.5
	Back	3.70	3.80	3.80	5.90	74
	Lumbar	1.10	1.20	1.20	1.80	22
	Accent	2.80	3.10	3.70	3.30	56
	Arms	2.80	3.20	3.80	3.90	58
N92H3M, N92HTU3M		12.80	13.80	15.80	14.50	253

COM Yardage Requirements

COM YARDAGE REQUIREMENTS (54" Width – Cut up the roll)

MODEL	Railroaded Contact customer service 800-482-1717 for ydg requirements	Non Directional Or Solid	1"-4" Repeat	5"-11" Repeat	12"-18" Repeat	COL Square Feet
			4" Vertical X 4" Horizontal	11" Vertical X 11" Horizontal	18" Vertical X 18" Horizontal	
N92H3MX, N92HTU3MX	Seat	5.60	6.30	6.70	7.30	111.5
	Back	3.70	3.80	3.80	5.90	74
	Lumbar	1.10	1.20	1.20	1.80	22
	Accent	2.80	3.10	3.70	3.30	56
N92H3R, N92H3RR, N92H3L, N92H3LL, N92HTU3R, N92HTU3RR, N92HTU3L, N92HTU3LL		14.10	15.30	17.10	17.40	281
N92H3RH, N92H3LH, N92HTU3RH, N92HTU3LH		15.60	16.40	19.20	18.20	311
N92H3RHX, N92H3LHX, N92HTU3RHX, N92HTU3LHX	Seat	5.60	6.30	6.70	7.30	111.5
	Back	3.70	3.80	4.50	5.90	74
	Lumbar	1.10	1.20	1.20	1.80	22
	Accent	2.80	3.10	3.70	3.30	56
	Arms	2.90	3.10	4.40	4.50	57.5
N92H3RM, N92H3LM, N92HTU3RM, N92HTU3LM		14.90	15.80	18.60	18.30	297
N92H3RMX, N92H3LMX, N92HTU3RMX, N92HTU3LMX	Seat	5.60	6.30	6.70	7.30	111.5
	Back	3.70	3.80	4.50	5.90	74
	Lumbar	1.10	1.20	1.20	1.80	22
	Accent	2.80	3.10	3.70	3.30	56
	Arms	2.20	2.40	3.70	4.10	44
N92H3RX, N92H3RRX, N92H3LX, N92H3LLX, N92HTU3RX, N92HTU3RRX, N92HTU3LX, N92HTU3LLX	Seat	5.60	6.30	6.70	7.30	111.5
	Back	3.70	3.80	3.80	5.90	74
	Lumbar	1.10	1.20	1.20	1.80	22
	Accent	2.80	3.10	3.70	3.30	56
	Arms	1.50	1.60	1.90	1.90	30
N92HC2		9.20	10.90	15.30	15.80	182.5
N92HC2X	Back	3.80	4.10	5.00	7.90	74
	Lumbar	0.70	0.80	1.20	1.80	12.5
	Seat	2.70	3.00	4.90	5.30	53
	Accent	2.90	4.10	4.90	4.30	55.5
N92HC3		16.00	18.90	23.10	23.80	319
N92HC3X	Back	5.40	5.90	7.50	8.60	107.5
	Lumbar	1.20	1.50	1.80	3.40	24
	Seat	6.60	8.40	9.30	10.50	131.5
	Accent	4.80	5.30	6.00	5.90	96
N92HIN9, N92HTUIN9		6.20	7.30	10.10	10.40	123.5
N92HIN9X, N92HTUIN9X	Seat	2.70	2.90	4.30	3.80	54
	Back	2.40	2.50	2.80	3.90	48
	Lumbar	0.70	0.80	0.90	1.30	14
	Accent	1.50	1.80	2.40	2.30	30
N92HOU9		5.00	5.70	7.10	7.00	97
N92HOU9X	Seat	2.70	2.90	4.30	3.90	54
	Back	1.40	1.50	1.50	2.20	28
	Lumbar	0.50	0.50	0.60	0.80	10
	Accent	1.00	1.10	1.20	1.30	18
N92HSQ9D, N92HTUSQ9D	Complete	5.50	6.90	8.80	9.20	109.5
N92HSQ9DX, N92HTUSQ9DX	Seat	2.70	2.80	3.60	3.30	54
	Back	2.00	2.10	3.00	3.20	40
	Lumbar	0.40	0.50	0.60	1.30	8
	Accent	1.40	2.10	2.40	2.30	28
N92HSQ9R, N92HSQ9L N92HTUSQ9R, N92HTUSQ9L	Complete	5.50	6.80	8.90	9.20	109.5
	Seat	2.60	2.80	3.60	3.30	52
	Back	2.00	2.20	3.00	3.20	40
	Lumbar	0.40	0.50	0.60	1.30	8
	Accent	1.40	2.10	2.40	2.30	28

COM Yardage

COM Yardage Requirements

COM YARDAGE REQUIREMENTS (54" Width – Cut up the roll)

MODEL	Railroaded Contact customer service 800-482-1717 for ydg requirements	Non Directional Or Solid	1"-4" Repeat	5"-11" Repeat	12"-18" Repeat	COL Square Feet
			4" Vertical X 4" Horizontal	11" Vertical X 11" Horizontal	18" Vertical X 18" Horizontal	
N92HTL2B, N92HTL2BR, N92HTL2BL, N92HTL2BB, N92HTW2B, N92HTW2BR, N92HTW2BL, N92HTW2BB		9.40	10.10	11.00	11.90	185.5
N92HTL2BX, N92HTL2BRX, N92HTL2BLX, N92HTL2BBX, N92HTW2BX, N92HTW2BRX, N92HTW2BLX, N92HTW2BBX	Seat Back Lumbar Accent Arms	3.20 1.20 0.70 1.90 2.80	3.60 1.30 0.80 2.10 3.20	3.70 1.30 0.90 2.50 3.80	4.30 1.90 1.30 2.30 3.90	63.75 24 13 35.5 58
N92HTL2M, N92HTW2M		6.70	7.50	8.50	7.90	133.5
N92HTL2MX, N92HTW2MX	Seat Back Lumbar Accent	3.20 1.20 0.70 1.90	3.60 1.30 0.80 2.10	3.70 1.30 0.90 2.50	4.30 1.90 1.30 2.30	63.75 24 13 35.5
N92HTL2R, N92HTL2RR, N92HTL2L, N92HTL2LL, N92HTW2R, N92HTW2RR, N92HTW2L, N92HTW2LL		8.10	8.90	9.80	9.9	161
N92HTL2RH, N92HTL2LH, N92HTW2RH, N92HTW2LH		9.50	10.30	11.90	13.40	189
N92HTL2RHX, N92HTL2LHX N92HTW2RHX, N92HTW2LHX	Seat Back Lumbar Accent Arms	3.20 1.20 0.70 1.90 2.90	3.60 1.30 0.80 2.00 3.10	3.70 1.30 0.90 2.50 4.40	4.30 1.90 1.30 2.30 4.50	63.75 24 13 35.5 57.5
N92HTL2RM, N92HTL2LM, N92HTW2RM, N92HTW2LM		8.80	9.60	11.20	14.00	175
N92HTL2RMX, N92HTL2LMX N92HTW2RMX, N92HTW2LMX	Seat Back Lumbar Accent Arms	3.20 1.20 0.70 1.90 2.20	3.60 1.30 0.80 2.00 2.40	3.70 1.30 0.90 2.50 3.70	4.30 1.90 1.30 2.30 4.10	63.75 24 13 35.5 44
N92HTL2RX, N92HTL2RRX, N92HTL2LX, N92HTL2LLX, N92HTW2RX, N92HTW2RRX, N92HTW2LX, N92HTW2LLX	Seat Back Lumbar Accent Arms	3.20 1.20 0.70 2.80 1.50	3.60 1.30 0.80 3.10 1.60	3.70 1.30 0.90 3.70 1.90	4.30 1.90 1.30 3.30 1.90	63.75 24 13 56 30
N92HTL3B, N92HTL3BR, N92HTL3BL, N92HTL3BB, N92HTW3B, N92HTW3BR, N92HTW3BL, N92HTW3BB		12.30	13.20	14.70	14.90	245
N92HTL3BH, N92HTW3BH		15.20	16.10	18.30	18.20	303
N92HTL3BHX, N92HTW3BHX	Seat Back Lumbar Accent Arms	4.40 2.70 1.10 2.80 5.70	4.80 2.80 1.20 3.10 5.90	4.90 3.30 1.20 3.70 7.50	5.90 3.30 1.80 3.30 7.50	88 54 22 56 113
N92HTL3BM, N92HTW3BM		13.70	14.50	17.40	17.20	273
N92HTL3BMX, N92HTW3BMX	Seat Back Lumbar Accent Arms	4.40 2.70 1.10 2.80 4.30	4.80 2.80 1.20 3.10 4.60	4.90 3.30 1.20 3.70 6.30	5.90 3.30 1.80 3.30 7.10	88 54 22 56 86
N92HTL3BX, N92HTL3BRX, N92HTL3BLX, N92HTL3BBX, N92HTW3BX, N92HTW3BRX, N92HTW3BLX, N92HTW3BBX	Seat Back Lumbar Accent Arms	4.40 2.70 1.10 2.80 2.80	4.80 2.80 1.20 3.10 3.20	4.90 3.30 1.20 3.70 3.80	5.90 3.30 1.80 3.30 3.90	88 54 22 56 58
N92HTL3M, N92HTW3M		9.60	10.50	11.60	10.50	191

COM Yardage Requirements

COM YARDAGE REQUIREMENTS (54" Width – Cut up the roll)

MODEL	Railroaded Contact customer service 800-482-1717 for ydg requirements	Non Directional Or Solid	1"-4" Repeat	5"-11" Repeat	12"-18" Repeat	COL Square Feet
			4" Vertical X 4" Horizontal	11" Vertical X 11" Horizontal	18" Vertical X 18" Horizontal	
N92HTL3MX, N92HTW3MX	Seat	4.40	4.80	4.90	5.90	88
	Back	2.70	2.80	3.30	3.30	54
	Lumbar	1.10	1.20	1.20	1.80	22
	Accent	2.80	3.10	3.70	3.30	56
N92HTL3R, N92HTL3RR, N92HTL3L, N92HTL3LL, N92HTW3R, N92HTW3RR, N92HTW3L, N92HTW3LL		10.90	11.80	13.40	12.80	217
N92HTL3RH, N92HTL3LH, N92HTW3RH, N92HTW3LH		12.30	13.10	15.20	13.80	245
N92HTL3RHX, N92HTL3LHX N92HTW3RHX, N92HTW3LHX	Seat	4.40	4.80	4.90	5.90	88
	Back	2.70	2.80	3.30	3.30	54
	Lumbar	1.10	1.20	1.20	1.80	22
	Accent	2.80	3.10	3.70	3.30	56
	Arms	2.90	3.10	4.40	4.50	57.5
N92HTL3RM, N92HTL3LM, N92HTW3RM, N92HTW3LM		11.70	12.40	14.30	14.30	233
N92HTL3RMX, N92HTL3LMX N92HTW3RMX, N92HTW3LMX	Seat	4.40	4.80	4.90	5.90	88
	Back	2.70	2.80	3.30	3.30	54
	Lumbar	1.10	1.20	1.20	1.80	22
	Accent	2.80	3.10	3.70	3.30	56
	Arms	2.20	2.40	3.70	4.10	44
N92HTL3RX, N92HTL3RRX, N92HTL3LX, N92HTL3LLX, N92HTW3RX, N92HTW3RRX, N92HTW3LX, N92HTW3LLX	Seat	4.40	4.80	4.90	5.90	88
	Back	2.70	2.80	3.30	3.30	54
	Lumbar	1.10	1.20	1.20	1.80	22
	Accent	2.80	3.10	3.70	3.30	56
	Arms	1.50	1.60	1.90	1.90	30
N92HTLIN9, N92HTWIN9		4.30	5.20	7.00	7.70	86
N92HTLIN9X, N92HTWIN9X	Seat	2.10	2.60	2.80	4.80	42
	Back	1.20	1.60	2.20	2.90	24
	Lumbar	0.70	0.80	0.90	1.30	14
	Accent	1.50	1.80	2.40	2.30	30
N92HTLSQ9D, N92HTWSQ9D		3.30	4.90	6.10	6.30	66
N92HTLSQ9D, N92HTWSQ9D	Seat	1.60	1.90	2.40	2.40	32
	Back	1.30	1.40	2.10	2.20	26
	Lumbar	0.40	0.50	0.60	1.30	8
	Accent	1.40	2.10	2.40	2.30	28
N92HTLSQ9R, N92HTLSQ9L, N92HTWSQ9R, N92HTWSQ9L		3.00	4.60	6.10	5.90	60
N92HTLSQ9RX, N92HTLSQ9LX, N92HTWSQ9RX, N92HTWSQ9LX	Seat	1.10	1.80	1.90	3.40	22
	Back	1.30	1.40	2.10	2.20	26
	Lumbar	0.40	0.50	0.60	1.30	8
	Accent	1.40	2.10	2.40	2.30	28
N92HTUC2		9.20	10.90	15.30	15.80	182.5
N92HTUC2X	Seat	2.70	3.00	4.90	5.30	53
	Back	3.80	4.10	5.00	7.90	74
	Lumbar	0.70	0.80	1.20	1.80	12.5
	Accent	2.90	4.10	4.90	4.30	55.5
N92HTUC3		12.70	13.80	15.80	14.50	253
N92HTUC3X	Seat	6.60	8.40	9.30	10.50	131.5
	Back	5.40	5.90	7.50	8.60	107.5
	Lumbar	1.20	1.50	1.80	3.40	24
	Accent	4.80	5.30	6.00	5.90	96
N92HTUSQ9RX, N92HTUSQ9LX	Seat	2.60	2.80	3.60	3.30	52
	Back	2.00	2.20	3.00	3.20	40
	Lumbar	0.40	0.50	0.60	1.30	8
	Accent	1.40	2.10	2.40	2.30	28
N92HTW2BH, N92HTL2BH		12.30	13.20	14.90	17.40	245

COM Yardage

COM Yardage Requirements

COM YARDAGE REQUIREMENTS (54" Width – Cut up the roll)

MODEL	Railroaded Contact customer service 800-482-1717 for ydg requirements	Non Directional Or Solid	1"-4" Repeat	5"-11" Repeat	12"-18" Repeat	COL Square Feet
			4" Vertical X 4" Horizontal	11" Vertical X 11" Horizontal	18" Vertical X 18" Horizontal	
N92HTW2BHX,N92HTL2BHX	Seat	3.20	3.60	3.70	4.30	63.75
	Back	1.20	1.30	1.30	1.90	24
	Lumbar	0.70	0.80	0.90	1.30	13
	Accent	1.90	2.00	2.50	2.30	35.5
	Arms	5.70	5.90	7.50	7.50	113
N92HTW2BM,N92HTL2BM		10.90	11.60	13.40	15.80	217
N92HTW2BMX,N92HTL2BMX	Seat	3.20	3.60	3.70	4.30	63.75
	Back	1.20	1.30	1.30	1.90	24
	Lumbar	0.70	0.80	0.90	1.30	13
	Accent	1.90	2.00	2.50	2.30	35.5
	Arms	4.30	4.60	6.30	7.10	86
N92HTWC2, N92HTLC2		5.10	7.20	11.00	10.20	102
N92HTWC2X, N92HTLC2X	Seat	1.70	1.90	2.60	3.40	34
	Back	1.70	1.90	2.50	3.90	34
	Lumbar	0.70	0.80	1.20	1.80	12.5
	Accent	2.90	4.10	4.90	4.30	55.5
N92HTWC3, N92HTLC3		6.80	10.00	14.90	12.40	136
N92HTWC3X, N92HTLC3X	Seat	2.30	3.00	3.80	4.90	46
	Back	1.90	2.50	3.10	4.90	38
	Lumbar	1.20	1.50	1.80	3.40	24
	Accent	4.80	5.30	6.00	5.90	96
N92M1B, N92M1BR, N92M1BL		6.80	7.30	8.30	9.40	133
N92M1BM		8.30	8.90	10.00	11.20	165.5
N92M1BMX	Seat	2.60	3.00	3.10	3.90	50
	Back	1.40	1.50	1.50	2.20	25
	Lumbar	0.40	0.50	0.60	0.80	7
	Arms	4.30	4.60	6.30	7.10	86
N92M1BX, N92M1BRX, N92M1BLX	Seat	2.60	3.00	3.10	3.90	50
	Back	1.40	1.50	1.50	2.20	25
	Lumbar	0.40	0.50	0.60	0.80	7
	Arms	2.80	3.20	3.80	3.90	58
N92M1M		4.10	4.70	4.90	5.40	80
N92M1MX	Seat	2.60	3.00	3.10	3.90	50
	Back	1.40	1.50	1.50	2.20	25
	Lumbar	0.40	0.50	0.60	0.80	7
N92M1R, N92M1RR, N92M1L, N92M1LL		5.50	6.00	6.50	7.40	107
N92M1RM,N92M1LM		6.20	6.80	7.60	8.30	123.5
N92M1RMX,N92M1LMX	Seat	2.60	3.00	3.10	3.90	50
	Back	1.40	1.50	1.50	2.20	25
	Lumbar	0.40	0.50	0.60	0.80	7
	Arms	2.20	2.40	3.70	4.10	44
N92M1RX,N92M1RRX N92M1LX,N92M1LLX	Seat	2.60	3.00	3.10	3.90	50
	Back	1.40	1.50	1.50	2.20	25
	Lumbar	0.40	0.50	0.60	0.80	7
	Arms	1.50	1.60	1.90	1.90	30
N92M2B, N92M2BR, N92M2BL, N92M2BB, N92MTU2B, N92MTU2BR, N92MTU2BL, N92MTU2BB		9.80	10.30	11.10	12.90	195
N92M2BM, N92MTU2BM		11.30	12.00	13.70	16.20	225
N92M2BMX, N92MTU2BMX	Seat	4.10	4.60	4.90	5.30	80
	Back	2.50	2.60	2.60	3.90	50
	Lumbar	0.70	0.80	0.90	1.30	13
	Arms	4.30	4.60	6.30	7.10	86
N92M2BX, N92M2BRX, N92M2BLX, N92M2BBX, N92MTU2BX, N92MTU2BRX, N92MTU2BLX, N92MTU2BBX	Seat	4.10	4.60	4.90	5.30	80
	Back	2.50	2.60	2.60	3.90	50
	Lumbar	0.70	0.80	0.90	1.30	13
	Arms	2.80	3.20	3.80	3.90	58

COM Yardage Requirements

COM YARDAGE REQUIREMENTS (54" Width – Cut up the roll)

MODEL	Railroaded Contact customer service 800-482-1717 for ydg requirements	Non Directional Or Solid	1"-4" Repeat	5"-11" Repeat	12"-18" Repeat	COL Square Feet
			4" Vertical X 4" Horizontal	11" Vertical X 11" Horizontal	18" Vertical X 18" Horizontal	
N92M2M, N92MTU2M		7.10	7.70	8.50	8.30	139.5
N92M2MX, N92MTU2MX	Seat	4.10	4.60	4.90	5.30	80
	Back	2.50	2.60	2.60	3.90	50
	Lumbar	0.70	0.80	0.90	1.30	13
N92M2R, N92M2RR, N92M2L, N92M2LL N92MTU2R, N92MTU2RR, N92MTU2L, N92MTU2LL		8.40	9.10	9.80	11.00	167
N92M2RM, N92M2LM, N92MTU2RM, N92MTU2LM		9.20	9.80	11.20	13.10	183
N92M2RMX, N92M2LMX, N92MTU2RMX, N92MTU2LMX	Seat	4.10	4.60	4.90	5.30	80
	Back	2.50	2.60	2.60	3.90	50
	Lumbar	0.70	0.80	0.90	1.30	13
	Arms	2.20	2.40	3.70	4.10	44
N92M2RX, N92M2RRX, N92M2LX, N92M2LLX, N92MTU2RX, N92MTU2RRX, N92MTU2LX, N92MTU2LLX	Seat	4.10	4.60	4.90	5.30	80
	Back	2.50	2.60	2.60	3.90	50
	Lumbar	0.70	0.80	0.90	1.30	13
	Arms	1.50	1.60	1.90	1.90	30
N92M3B, N92M3BR, N92M3BL, N92M3BB, N92MTU3B, N92MTU3BR, N92MTU3BL, N92MTU3BB		12.80	13.80	15.00	16.90	255
N92M3BM, N92MTU3BM		14.30	15.10	17.40	18.20	285
N92M3BMX, N92MTU3BMX	Seat	5.60	6.30	6.70	7.30	111.5
	Back	3.70	3.80	4.50	5.90	74
	Lumbar	1.10	1.20	1.20	1.80	22
	Arms	4.30	4.60	6.30	7.10	86
N92M3BX, N92M3BRX, N92M3BLX, N92M3BBX, N92MTU3BX, N92MTU3BRX, N92MTU3BLX, N92MTU3BBX	Seat	5.60	6.30	6.70	7.30	111.5
	Back	3.70	3.80	3.80	5.90	74
	Lumbar	1.10	1.20	1.20	1.80	22
	Arms	2.80	3.20	3.80	3.90	58
N92M3M, N92MTU3M		10.10	11.00	12.20	12.90	199
N92M3MX, N92MTU3MX	Seat	5.60	6.30	6.70	7.30	111.5
	Back	3.70	3.80	4.50	5.90	74
	Lumbar	1.10	1.20	1.20	1.80	22
N92M3R, N92M3RR, N92M3L, N92M3LL, N92MTU3R, N92MTU3RR, N92MTU3L, N92MTU3LL		11.50	12.40	13.40	14.90	229
N92M3RM, N92M3LM, N92MTU3RM, N92MTU3LM		12.20	13.10	14.90	15.20	243
N92M3RMX, N92M3LMX, N92MTU3RMX, N92MTU3LMX	Seat	5.60	6.30	6.70	7.30	111.5
	Back	3.70	3.80	3.80	5.90	74
	Lumbar	1.10	1.20	1.20	1.80	22
	Arms	2.20	2.40	3.70	4.10	44
N92M3RX, N92M3RRX, N92M3LX, N92M3LLX, N92MTU3RX, N92MTU3RRX, N92MTU3LX, N92MTU3LLX	Seat	5.60	6.30	6.70	7.30	111.5
	Back	3.70	3.80	3.80	5.90	74
	Lumbar	1.10	1.20	1.20	1.80	22
	Arms	1.50	1.60	1.90	1.90	30
N92MC2		6.60	7.20	10.40	11.40	130
N92MC2X	Back	3.80	4.10	5.00	7.90	74
	Lumbar	0.70	0.80	1.20	1.80	12.5
	Seat	2.70	3.00	4.90	5.30	53
N92MC3		11.70	14.10	16.90	18.80	233
N92MC3X	Back	5.40	5.90	7.50	8.60	107.5
	Lumbar	1.20	1.50	1.80	3.40	24
	Seat	6.60	8.40	9.30	10.50	131.5
N92MIN9, N92MTUIN9		5.10	5.50	7.40	7.80	102

COM Yardage Requirements

COM YARDAGE REQUIREMENTS (54" Width – Cut up the roll)

MODEL	Railroaded Contact customer service 800-482-1717 for ydg requirements	Non Directional Or Solid	1"-4" Repeat	5"-11" Repeat	12"-18" Repeat	COL Square Feet
			4" Vertical X 4" Horizontal	11" Vertical X 11" Horizontal	18" Vertical X 18" Horizontal	
N92MIN9X, N92MTUIN9X	Seat	2.70	2.90	4.30	3.80	54
	Back	2.40	2.50	2.80	3.90	48
	Lumbar	0.70	0.80	0.90	1.30	14
N92MOU9		4.20	4.60	5.80	6.00	84
N92MOU9X	Seat	2.70	2.90	4.30	3.90	54
	Back	1.40	1.50	1.50	2.20	28
	Lumbar	0.50	0.50	0.60	0.80	10
N92MSQ9D, N92MTUSQ9D	Complete	4.30	5.10	5.50	7.20	86
N92MSQ9DX, N92MTUSQ9DX	Seat	2.70	2.80	3.60	3.30	54
	Back	2.00	2.10	3.00	3.20	40
	Lumbar	0.40	0.50	0.60	1.30	8
N92MSQ9R, N92MSQ9L, N92MTUSQ9R, N92MTUSQ9L	Complete	4.30	5.10	6.60	7.20	86
N92MSQ9RX, N92MSQ9LX N92MTUSQ9RX, N92MTUSQ9LX	Seat	2.60	2.80	3.60	3.30	52
	Back	2.00	2.10	3.00	3.20	40
	Lumbar	0.40	0.50	0.60	1.30	8
N92MTL2B, N92MTL2BR, N92MTL2BL, N92MTL2BB, N92MTW2B, N92MTW2BR, N92MTW2BL, N92MTW2BB		7.60	8.10	9.20	10.30	151
N92MTL2BX, N92MTL2BRX, N92MTL2BLX, N92MTL2BBX, N92MTW2BX, N92MTW2BRX, N92MTW2BLX, N92MTW2BBX	Seat	3.20	3.60	3.70	4.30	63.75
	Back	1.20	1.30	1.30	1.90	24
	Lumbar	0.70	0.80	0.90	1.30	13
	Arms	2.80	3.20	3.80	3.90	58
N92MTL2M, N92MTW2M		5.00	5.30	6.10	5.80	100
N92MTL2MX, N92MTW2MX	Seat	3.20	3.60	3.70	4.30	63.75
	Back	1.20	1.30	1.30	1.90	24
	Lumbar	0.70	0.80	0.90	1.30	13
N92MTL2R, N92MTL2RR, N92MTL2L, N92MTL2LL, N92MTW2R, N92MTW2RR, N92MTW2L, N92MTW2LL		6.30	6.80	7.40	8.40	125.5
N92MTL2RX, N92MTL2RRX, N92MTL2LX, N92MTL2LLX, N92MTW2RX, N92MTW2RRX, N92MTW2LX, N92MTW2LLX	Seat	3.20	3.60	3.70	4.30	63.75
	Back	1.20	1.30	1.30	1.90	24
	Lumbar	0.70	0.80	0.90	1.30	13
	Arms	1.50	1.60	1.90	1.90	30
N92MTL3B, N92MTL3BR, N92MTL3BL, N92MTL3BB, N92MTW3B, N92MTW3BR, N92MTW3BL, N92MTW3BB		9.60	10.30	11.30	12.80	191
N92MTL3BM, N92MTW3BM		11.10	11.80	13.40	14.90	221
N92MTL3BMX, N92MTW3BMX	Seat	4.40	4.80	4.90	5.90	88
	Back	2.70	2.80	3.30	3.30	54
	Lumbar	1.10	1.20	1.20	1.80	22
	Arms	4.30	4.60	6.30	7.10	86
N92MTL3BX, N92MTL3BRX, N92MTL3BLX, N92MTL3BBX, N92MTW3BX, N92MTW3BRX, N92MTW3BLX, N92MTW3BBX	Seat	4.40	4.80	4.90	5.90	88
	Back	2.70	2.80	3.30	3.30	54
	Lumbar	1.10	1.20	1.20	1.80	22
	Arms	2.80	3.20	3.80	3.90	58
N92MTL3M, N92MTW3M		6.90	7.60	8.50	8.90	137.5
N92MTL3MX, N92MTW3MX	Seat	4.40	4.80	4.90	5.90	88
	Back	2.70	2.80	3.30	3.30	54
	Lumbar	1.10	1.20	1.20	1.80	22
N92MTL3R, N92MTL3RR, N92MTL3L, N92MTL3LL, N92MTW3R, N92MTW3RR, N92MTW3L, N92MTW3LL		8.30	8.90	9.80	10.30	165

COM Yardage Requirements

COM YARDAGE REQUIREMENTS (54" Width – Cut up the roll)

MODEL	Railroaded Contact customer service 800-482-1717 for ydg requirements	Non Directional Or Solid	1"-4" Repeat	5"-11" Repeat	12"-18" Repeat	COL Square Feet
			4" Vertical X 4" Horizontal	11" Vertical X 11" Horizontal	18" Vertical X 18" Horizontal	
N92MTL3RX, N92MTL3RRX, N92MTL3LX, N92MTL3LLX, N92MTW3RX, N92MTW3RRX, N92MTW3LX, N92MTW3LLX	Seat Back Lumbar Arms	4.40 2.70 1.10 1.50	4.80 2.80 1.20 1.60	4.90 3.30 1.20 1.90	5.90 3.30 1.80 1.90	88 54 22 30
N92MTLIN9, N92MTWIN9		3.10	3.80	4.50	6.40	62
N92MTLIN9X, N92MTWIN9X	Seat Back Lumbar	2.10 1.20 0.70	2.60 1.60 0.80	2.80 2.20 0.90	4.80 2.90 1.30	42 24 14
N92MTLSQ9D, N92MTWSQ9D		2.30	3.00	3.90	4.40	46
N92MTLSQ9DX, N92MTWSQ9DX	Seat Back Lumbar	1.60 1.30 0.40	1.90 1.40 0.50	2.40 2.10 0.60	2.40 2.20 1.30	32 26 8
N92MTLSQ9R, N92MTLSQ9L, N92MTWSQ9R, N92MTWSQ9L		2.10	2.60	3.70	4.90	42
N92MTLSQ9RX, N92MTLSQ9LX, N92MTWSQ9RX, N92MTWSQ9LX	Seat Back Lumbar	1.10 1.30 0.40	1.80 1.40 0.50	1.90 2.10 0.60	3.40 2.20 1.30	22 26 8
N92MTUC2		6.60	7.20	10.40	11.40	130
N92MTUC2X	Seat Back Lumbar	2.70 3.80 0.70	3.00 4.10 0.80	4.90 5.00 1.20	5.30 7.90 1.80	53 74 12.5
N92MTUC3		11.70	14.10	16.90	18.80	233
N92MTUC3X	Seat Back Lumbar	6.60 5.40 1.20	8.40 5.90 1.50	9.30 7.50 1.80	10.50 8.60 3.40	131.5 107.5 24
N92MTW2BM, N92MTL2BM		9.10	9.70	11.20	13.70	181.5
N92MTW2BMX, N92MTL2BMX	Seat Back Lumbar Arms	3.20 1.20 0.70 4.30	3.60 1.30 0.80 4.60	3.70 1.30 0.90 6.30	4.30 1.90 1.30 7.10	63.75 24 13 86
N92MTW2RM, N92MTW2LM, N92MTL2RM, N92MTL2LM		7.00	7.50	8.80	10.90	139.5
N92MTW2RMX, N92MTW2LMX, N92MTL2RMX, N92MTL2LMX	Seat Back Lumbar Arms	3.20 1.20 0.70 2.20	3.60 1.30 0.80 2.40	3.70 1.30 0.90 3.70	4.30 1.90 1.30 4.10	63.75 24 13 44
N92MTW3RM, N92MTW3LM, N92MTL3RM, N92MTL3LM		9.00	9.70	10.70	11.90	179
N92MTW3RMX, N92MTW3LMX, N92MTL3RMX, N92MTL3LMX	Seat Back Lumbar Arms	4.40 2.70 1.10 2.20	4.80 2.80 1.20 2.40	4.90 3.30 1.20 3.70	5.90 3.30 1.80 4.10	88 54 22 44
N92MTWC2, N92MTLC2		3.20	3.90	6.10	7.40	64
N92MTWC2X, N92MTLC2X	Seat Back Lumbar	1.70 1.70 0.70	1.90 1.90 0.80	2.60 2.50 1.20	3.40 3.90 1.80	34 34 12.5
N92MTWC3, N92MTLC3		4.30	5.90	8.80	9.40	86
N92MTWC3X, N92MTLC3X	Seat Back Lumbar	2.30 1.90 1.20	3.00 2.50 1.50	3.80 3.10 1.80	4.90 4.90 3.40	46 38 24
N95AA, N95AAC		5.80	7.00	8.40	9.50	116
N95AAL, N95AALC		5.80	7.00	8.40	9.50	116
N95AAR, N95AARC		5.80	7.00	8.40	9.40	116

COM Yardage

COM Yardage Requirements

COM YARDAGE REQUIREMENTS (54" Width – Cut up the roll)

MODEL	Railroaded Contact customer service 800-482-1717 for ydg requirements	Non Directional Or Solid	1"-4" Repeat	5"-11" Repeat	12"-18" Repeat	COL Square Feet
			4" Vertical X 4" Horizontal	11" Vertical X 11" Horizontal	18" Vertical X 18" Horizontal	
N95AAX, N95AACX	Back	0.90	1.00	1.10	1.00	8
N95AARX, N95AARCX	Extreme	1.00	1.00	1.20	1.10	9
N95AALX, N95AALCX	Back Accent	1.00	1.00	1.20	1.10	6
	Seat	1.30	1.40	1.80	1.70	12
	Seat Accent	1.00	1.00	1.20	1.30	17
	Arm	2.50	2.80	3.80	4.00	48
N95BB		7.00	10.60	12.70	13.90	140
N95BBB		7.00	10.60	12.70	13.90	140
N95BBL		7.00	10.60	12.70	13.90	140
N95BBR		7.00	10.60	12.70	13.90	140
N95BBX,	Back	1.40	1.70	2.00	2.00	26
N95BBRX,	Extreme	1.80	1.90	2.10	2.10	34
N95BBLX,	Back Accent	1.00	1.00	1.20	1.10	6
N95BBBX	Seat	1.90	3.40	4.00	4.30	35
	Seat Accent	1.00	1.00	1.20	1.30	17
	Arm	2.50	2.80	3.80	4.00	48
N95CC		9.00	14.10	16.30	18.40	179
N95CCB		9.00	14.10	16.30	18.40	179
N95CCL		9.00	14.10	16.30	18.40	179
N95CCR		9.00	14.10	16.30	18.40	179
N95CCX,	Back	1.70	2.50	3.00	3.00	31
N95CCRX,	Extreme	2.60	2.80	3.00	3.00	50.5
N95CCLX,	Back Accent	1.00	1.00	1.20	1.10	6
N95CCBX	Seat	3.00	5.30	6.10	6.80	58
	Seat Accent	1.00	1.00	1.20	1.30	17
	Arm	2.50	2.80	3.80	4.00	48
N95DD		2.60	2.90	3.20	3.50	52
N95DDX	Seat	1.70	1.80	1.80	1.90	22.5
	Seat Accent	1.00	1.00	1.30	1.40	18
N95EE		3.40	5.50	6.20	6.50	68
N95EEX	Seat	2.60	4.50	4.90	5.40	49.25
	Seat Accent	1.00	1.00	1.30	1.40	18
N95GG		5.90	8.00	9.30	9.50	118
N95GGX	Seat	5.00	7.00	8.00	8.40	98
	Seat Accent	1.00	1.00	1.30	1.40	18
N95MA, N95MAC		3.20	4.30	5.00	5.40	64
N95MAL		4.20	5.70	6.60	7.40	84
N95MALT		4.20	5.70	6.60	7.40	84
N95MAR		4.20	5.70	6.60	7.40	84
N95MART		4.20	5.70	6.60	7.40	84
N95MARX,	Back	0.90	1.00	1.10	1.00	8
N95MARTX,	Extreme	1.00	1.00	1.20	1.10	9
N95MALX,	Back Accent	1.00	1.00	1.20	1.10	6
N95MALTX	Seat	1.30	1.40	1.80	1.70	12
	Seat Accent	1.00	1.00	1.20	1.30	17
	Arm	1.50	1.50	2.00	2.00	27
N95MAX, N95MACX	Back	0.90	1.00	1.10	1.00	8
	Extreme	1.00	1.00	1.20	1.10	9
	Back Accent	1.00	1.00	1.20	1.10	6
	Seat	1.30	1.40	1.80	1.70	12
	Seat Accent	1.00	1.00	1.20	1.30	17
N95MB		5.10	7.90	9.30	9.90	102
N95MBL		6.10	9.20	10.50	11.90	122
N95MBLT		6.10	9.20	10.50	11.90	122
N95MBR		6.10	9.20	10.50	11.90	122
N95MBRT		6.10	9.20	10.50	11.90	122

COM Yardage Requirements

COM YARDAGE REQUIREMENTS (54" Width – Cut up the roll)

MODEL	Railroaded Contact customer service 800-482-1717 for ydg requirements	Non Directional Or Solid	1"-4" Repeat	5"-11" Repeat	12"-18" Repeat	COL Square Feet
			4" Vertical X 4" Horizontal	11" Vertical X 11" Horizontal	18" Vertical X 18" Horizontal	
N95MBRX, N95MBRTX, N95MBLX, N95MBLTX	Back	1.40	1.70	2.00	2.00	26
	Extreme	1.80	1.90	2.10	2.10	34
	Back Accent	1.00	1.00	1.20	1.10	6
	Seat	1.90	3.40	4.00	4.30	35
	Seat Accent	1.00	1.00	1.20	1.30	17
	Arm	1.50	1.50	2.00	2.00	27
N95MBX	Back	1.40	1.70	2.00	2.00	26
	Extreme	1.80	1.90	2.10	2.10	34
	Back Accent	1.00	1.00	1.20	1.10	6
	Seat	1.90	3.40	4.00	4.30	35
	Seat Accent	1.00	1.00	1.20	1.30	17
N95MC		7.10	11.40	13.00	14.40	142
N95MCL		8.10	12.80	14.50	16.40	162
N95MCLT		8.10	12.80	14.50	16.40	162
N95MCR		8.10	12.80	14.50	16.40	162
N95MCRT		8.10	12.80	14.50	16.40	162
N95MCRX, N95MCRTX, N95MCLX, N95MCLTX	Back	1.70	2.50	3.00	3.00	31
	Extreme	2.60	2.80	3.00	3.00	50.5
	Back Accent	1.00	1.00	1.20	1.10	6
	Seat	3.00	5.30	6.10	6.80	58
	Seat Accent	1.00	1.00	1.20	1.30	17
	Arm	1.50	1.50	2.00	2.00	27
N95MCX	Back	1.70	2.50	3.00	3.00	31
	Extreme	2.60	2.80	3.00	3.00	50.5
	Back Accent	1.00	1.00	1.20	1.10	6
	Seat	3.00	5.30	6.10	6.80	58
	Seat Accent	1.00	1.00	1.20	1.30	17
N95MH		2.60	3.30	4.10	5.00	52
N95MHX	Back	0.90	1.00	1.10	1.00	17
	Extreme	1.00	1.00	1.20	1.10	10.5
	Back Accent	1.00	1.00	1.20	1.10	6
	Seat	1.40	1.40	1.70	1.80	26.5
	Seat Accent	1.00	1.00	1.20	1.30	17
N95MHA		2.60	3.40	4.10	4.40	52
N95MHAX	Back	0.90	1.00	1.10	1.00	17
	Extreme	1.00	1.00	1.20	1.10	6
	Back Accent	1.00	1.00	1.20	1.10	6
	Seat	1.50	1.60	1.70	1.80	28
	Seat Accent	1.00	1.00	1.20	1.30	17
N95MJ		3.30	3.70	5.00	5.20	66
N95MJX	Back	1.00	1.00	1.20	1.00	17
	Extreme	1.00	1.00	1.20	1.10	12.5
	Back Accent	1.00	1.00	1.20	1.10	6
	Seat	1.50	1.60	1.70	1.80	29
	Seat Accent	1.00	1.00	1.20	1.30	17
N95MJA		2.50	3.30	3.70	4.40	50
N95MJAX	Back	0.90	0.90	1.10	1.00	15
	Extreme	1.00	1.00	1.20	1.10	4.5
	Back Accent	1.00	1.00	1.20	1.10	6
	Seat	1.50	1.60	1.70	3.30	28
	Seat Accent	1.00	1.00	1.20	1.30	17
N95MK		4.10	4.40	6.60	7.10	82
N95MKX	Back	1.70	1.70	2.00	2.00	31
	Extreme	1.80	1.90	2.10	2.10	34
	Back Accent	1.00	1.00	1.20	1.10	6
	Seat	1.40	1.50	1.70	1.80	26.5
	Seat Accent	1.00	1.00	1.20	1.30	17
N95MKA		3.40	3.70	4.60	6.00	68

COM Yardage Requirements

COM YARDAGE REQUIREMENTS (54" Width – Cut up the roll)

MODEL	Railroaded Contact customer service 800-482-1717 for ydg requirements	Non Directional Or Solid	1"-4" Repeat	5"-11" Repeat	12"-18" Repeat	COL Square Feet
			4" Vertical X 4" Horizontal	11" Vertical X 11" Horizontal	18" Vertical X 18" Horizontal	
N95MKAX	Back	0.90	1.00	1.10	1.00	15
	Extreme	1.00	1.00	1.20	1.10	6
	Back Accent	1.00	1.00	1.20	1.30	17
	Seat	2.00	2.20	2.60	4.70	39
	Seat Accent	1.00	1.00	1.20	1.30	17
NAC1824CUSH		0.70	1.20	1.50	2.70	12
NAC1830CUSH		0.90	1.40	1.70	2.70	17
NAC1836CUSH		1.10	1.40	1.70	2.70	20
NAC1848CUSH		1.00	1.40	1.70	2.70	20
NAC1860CUSH		1.60	1.80	2.90	4.20	32
NAC1872CUSH		1.70	2.10	2.90	4.20	37
NAC2124CUSH		0.70	1.20	1.70	2.70	13
NAC2130CUSH		1.00	1.40	1.70	2.70	18.5
NAC2136CUSH		1.10	1.40	1.70	2.70	21
NAC2148CUSH		1.10	1.40	1.70	2.70	22
NAC2160CUSH		1.80	2.50	2.90	4.20	36
NAC2172CUSH		1.90	2.50	2.90	4.20	38
NAC2424CUSH		0.80	1.70	2.30	2.70	14.5
NAC2430CUSH		1.20	1.70	2.30	2.70	23
NAC2436CUSH		1.20	1.70	2.30	2.70	23
NAC2448CUSH		1.20	1.60	2.30	2.70	24
NAC2460CUSH		2.10	2.70	3.80	4.20	42
NAC2472CUSH		2.10	2.70	3.80	4.20	42
451		3.30	4.05	5.35	5.90	67
451T		3.60	4.15	5.30	5.90	73
452		3.30	4.05	5.35	5.90	67
452T		3.60	4.15	5.30	5.90	73

A.C.T. Icons

A.C.T. PERFORMANCE ICONS

A.C.T. (The Association for Contract Textiles), an organization made up of some 40 contract textile houses (Jobbers) has introduced a simple visual system for several ASTM and AATCC test standards.

These icons do not represent new testing for fabrics. National, as have many manufacturers, has always used these standards as requirements when developing fabrics. These icons were developed to create a common vernacular among textile companies and manufacturers in order to give specifiers uniform technical guidelines.

In order to use the A.C.T. icons, fabrics must pass the minimum requirements as established by ASTM (American Society of Testing and Materials) and AATCC (American Association of Textile Colorists and Chemists).

All National fabrics meet, and in most cases exceed the minimum requirements as set up by A.C.T. For the purpose of uniformity in the industry, National will be utilizing the A.C.T. icons on swatch cards and related materials.

Fire Retardancy



Flammability testing determines a fabric's resistance to burning.

APPLICATION	PASSES
Upholstery	California 117
Panels and Upholstered Walls	ASTM E 84 (unadhered method)

Colorfastness to Light



Colorfastness to light is the degree to which fabric will retain its color when exposed to light.

APPLICATION	PASSES
Upholstery	AATCC 16 Option 1 or 3 Class 4 minimum at 40 hours
Panels and Upholstered Walls	AATCC 16 Option 1 or 3 Class 4 minimum at 40 hours

Abrasion

Abrasion is the ability of a fabric to withstand damage from wear and rubbing. There is a general contract specification as well as a heavy-duty specification.



APPLICATION	PASSES
Heavy-duty Upholstery	ASTM 3597 modified (#10 cotton duck) 30,000 double rubs Wyzenbeck method or ASTM D4966 (with 21 oz. weight) 40,000 rubs Martindale method



Upholstery	ASTM 3597 modified (#10 cotton duck) 15,000 double rubs Wyzenbeck method
------------	--

Colorfastness to Wet & Dry Crocking



Colorfastness to wet & dry crocking refers to the rubbing off of color from the fabric onto clothing, hands or other materials and can occur under wet or dry conditions.

APPLICATION	PASSES
Upholstery	AATCC 8 Dry Crocking, Class 4 minimum Wet Crocking, Class 3 minimum
Panels and Upholstered Walls	AATCC 8, Class 3 minimum

Physical Properties



3 physical property tests include:

Brush pill test to determine a fabric's piling

Breaking/tensile strength is the ability of a fabric to withstand tension without breaking or tearing

Seam slippage is the pulling apart of fabrics at the seams

APPLICATION	PASSES
Upholstery	Brush pill ASTM D3511, 3 minimum Breaking strength ASTM D5034 50lbs. minimum in warp & welt Seam slippage ASTM D4034 25 lbs minimum in warp & welt
Panels and Upholstered Walls	Breaking strength ASTM D5034 Grab Method 35 lbs. minimum in warp & welt

Model	Page	Model	Page	Model	Page	Model	Page
10N1622RTPUL	96, 133, 170, 316, 321, 351, 376	88X-GRXX	443	N12DRS	288	N13HRS	294
10N1622RTPUW	96, 133, 170, 316, 321, 351, 376	88X-MNFXC	442	N12DRY	302	N13JJC	292
15NTVMAS	196	88X-MNFXCJ	442	N12EEC	295	N13JJCS	292
39A-BWAA	422	88X-MRFXC	442	N12EECS	295	N13JJY	306
39A-BWAAT	422	88X-MRFXCJ	442	N12ER	293	N13JR	290
39A-GRXX	425	89X-EUEXC	441	N12ERS	293	N13JRS	290
39A-GWXX	420	89X-EUFXC	441	N12HHC	295	N13JRY	303
39A-GWXXT	420	89X-EUFXCJ	441	N12HHCS	295	N13KKC	292
39A-TAA	421	89X-EWECC	440	N12HR	293	N13KKCS	292
39A-TAAA	421	89X-EWECCJ	440	N12HRS	293	N13KKY	306
39A-TAAAT	421	89X-EWEXC	440	N12JJC	291	N13KR	290
39A-TAAT	421	89X-EWEXCJ	440	N12JJCE	291	N13KRS	290
39B-GRXX	423	89X-GWXX	441	N12JJCES	291	N13KRY	303
39B-GWXX	418	89X-MUEXC	441	N12JJCS	291	N13MMC	296
39B-GWXXT	418	89X-MUFXC	441	N12JJY	305	N13MMCS	296
39CB	425	89X-MUFXCJ	441	N12JJYE	305	N13MR	294
39D-GRXX	424	89X-MWECC	441	N12JR	289	N13MRS	294
39D-GWXX	419	89X-MWECCJ	441	N12JRE	289	N13PPC	296
39D-GWXXT	419	89X-MWEXC	440	N12JRES	289	N13PPCS	296
39E-GRXX	423	89X-MWEXCJ	440	N12JRS	289	N13PR	294
39E-GWXX	418	CBV2219DB	200	N12JRY	302	N13PRS	294
39E-GWXXT	418	CBV2219DLB	198	N12JRYE	303	N14AAC	298
39H-GRXX	423	CBV2219DLN	198	N12KKC	291	N14AACS	298
39H-GWXX	418	CBV2219DLS	198	N12KKCE	291	N14AAY	307
39H-GWXXT	418	CBV2219DN	200	N12KKCES	291	N14AR	297
39L-GRXX	423	CBV2219DS	200	N12KKCS	291	N14ARS	297
39L-GWXX	418	CBV2219SQB	200	N12KKY	305	N14ARY	306
39L-GWXXT	418	CBV2219SQDLB	198	N12KKYE	305	N14BBC	298
39S-GRXX	424	CBV2219SQDLN	198	N12KR	289	N14BBCS	298
39S-GWXX	420	CBV2219SQDLS	198	N12KRE	289	N14BBY	307
39S-GWXXT	420	CBV2219SQN	200	N12KRES	289	N14BR	297
39SJ	425	CBV2219SQS	200	N12KRS	289	N14BRS	297
39T-SGLW	422	N10PBL1806	430	N12KRY	302	N14BRY	306
39T-SGW	422	N10PBL1806P	430	N12KRYE	303	N14CCC	299
39T-SHLW	423	N10PRT1508	431	N12MMC	295	N14CCCS	299
39T-SHW	423	N10PRT1508C	431	N12MMCE	295	N14CCY	308
39U-GRXX	424	N10PRT1508CP	431	N12MMCES	295	N14CR	297
39U-GWXX	419	N10PRT1508L	431	N12MMCS	295	N14CRS	297
39U-GWXXT	419	N10PRT1508LP	431	N12MR	293	N14CRY	307
451	54	N10PRT1508P	431	N12MRE	293	N14DDC	299
451T	54	N10PRT1508R	431	N12MRES	293	N14DDCS	299
452	55	N10PRT1508RP	431	N12MRS	293	N14DDY	308
452T	55	N10PSQ1414	431	N12PPC	295	N14DR	297
48-EK	54	N10PSQ1414B	431	N12PPCE	295	N14DRS	297
48-EKJ	54	N10PSQ1414BP	431	N12PPCS	295	N14DRY	307
48-EKN	54	N10PWD1816	434	N12PPCS	295	N14EEC	300
48-EKNJ	54	N10PWD2116	434	N12PRE	293	N14EECS	300
48-ES	54	N10PWD2416	434	N12PRES	293	N14ER	299
48-ESJ	54	N12AAC	290	N12PRS	293	N14ERS	299
48-ESN	54	N12AACS	290	N12QQ	297	N14HHC	300
48-ESNJ	54	N12AAY	304	N12RR	297	N14HHCS	300
48-GC	54	N12AR	288	N13CCC	292	N14HR	299
48-GCN	54	N12ARS	288	N13CCCS	292	N14HRS	299
62X-AUXX	321	N12ARY	301	N13CCY	305	N14JJC	299
62X-GUXX	320	N12BBC	290	N13CR	289	N14JJCS	299
62X-LUXX	320	N12BBCS	290	N13CRS	289	N14JJY	308
62X-UUXX	320	N12BBY	304	N13CRY	303	N14JR	298
64X-GWXX	55	N12BR	288	N13DDC	292	N14JRS	298
72X-GUXT	55	N12BRS	288	N13DDCS	292	N14JRY	307
72X-GUXX	55	N12BRY	301	N13DDY	305	N14KCC	299
85N2024EN	134	N12CCC	291	N13DR	289	N14KKCS	299
85N2024ENLW	134	N12CCCS	291	N13DRS	289	N14KKY	308
85N2040MG	134	N12CCY	304	N13DRY	303	N14KR	298
85N2040MGLW	134	N12CR	288	N13EEC	296	N14KRS	298
88-2424TP	444	N12CRS	288	N13EECS	296	N14KRY	307
88-3333TP	444	N12CRY	302	N13ER	294	N14MMC	301
88X-ENFXC	442	N12DDC	291	N13ERS	294	N14MMCS	301
88X-ENFXCJ	442	N12DDCS	291	N13HHC	296	N14MR	300
88X-GMXX	443	N12DDY	304	N13HCS	296	N14MRS	300
		N12DR	288	N13HR	294	N14PPC	301
						N14PPCS	301

Index

Model	Page	Model	Page	Model	Page	Model	Page
N14PR	300	N17ER	275	N23SSC	224	N30GM9PNC	256
N14PRS	300	N17ERS	275	N24AAC	222	N30GM9PP	256
N14QQ	301	N17GG	276	N24BBC	222	N30GM9PPC	256
N14RR	301	N17GGS	276	N24CCC	222	N30GM9UN	256
N15AAY	280	N17GR	275	N24CCCD	223	N30GM9UNC	256
N15ARY	278	N17GRS	275	N24DDC	224	N30GM9UP	256
N15CCY	281	N17HH	277	N24DDCD	225	N30GM9UPC	256
N15CRY	278	N17HHS	277	N24EEC	222	N30GP1PN	257
N15EE	273	N17HR	275	N24EECD	223	N30GP1PNC	257
N15EES	273	N17HRS	275	N24HHC	224	N30GP1PP	257
N15ER	270	N17JJY	285	N24HHCD	225	N30GP1PPC	257
N15ERS	270	N17JRY	283	N24JJC	223	N30GP1UN	257
N15GG	272	N17LL	276	N24KKC	225	N30GP1UNC	257
N15GGS	272	N17LLS	276	N24MMC	223	N30GP1UP	257
N15GR	270	N17LR	275	N24PPC	225	N30GP1UPC	257
N15GRS	270	N17LRS	275	N24RRC	224	N30GP9PN	257
N15HH	273	N17MMS	277	N24SSC	224	N30GP9PNC	257
N15HHS	273	N17MMS	277	N25AAC	227	N30GP9PP	257
N15HR	270	N17MR	276	N25AACY	230	N30GP9PPC	257
N15HRS	270	N17MRS	276	N25BBC	227	N30GP9UN	257
N15JJY	281	N17PP	277	N25BBCY	230	N30GP9UNC	257
N15JJYE	281	N17PPS	277	N25CCC	227	N30GP9UP	257
N15JRY	279	N17PR	276	N25CCCD	228	N30GP9UPC	257
N15JRYE	279	N17PRS	276	N25CCCX	231	N30GU1PN	258
N15LL	272	N17RR	277	N25CCCXD	231	N30GU1PNC	258
N15LLS	272	N21AAC	142	N25CCCY	230	N30GU1PP	258
N15LR	270	N21AAG	142	N25CCCYD	230	N30GU1PPC	258
N15LRS	270	N21AATC	142	N25DDC	229	N30GU1UN	258
N15MM	273	N21AATG	142	N25DDCD	229	N30GU1UNC	258
N15MME	273	N21AATUC	142	N25DDCX	231	N30GU1UP	258
N15MMES	273	N21AATUG	142	N25DDCXD	232	N30GU1UPC	258
N15MMS	273	N21AAUC	142	N25EEC	227	N30GU9PN	259
N15MR	271	N21AAUG	142	N25EECD	228	N30GU9PNC	259
N15MRE	271	N21BBC	143	N25EECY	230	N30GU9PP	259
N15MRES	271	N21BBG	143	N25EECYD	230	N30GU9PPC	259
N15MRS	271	N21BBTC	143	N25HHC	229	N30GU9UN	259
N15PP	273	N21BBTG	143	N25HHCD	229	N30GU9UNC	259
N15PPE	273	N21BBTUC	143	N25JJC	227	N30GU9UP	259
N15PPES	273	N21BBTUG	143	N25KKC	229	N30GU9UPC	259
N15PPS	273	N21BBUC	143	N25MMC	227	N30HM1SN	246
N15PR	271	N21BBUG	143	N25PPC	229	N30HM1SP	246
N15PRE	271	N21CCC	144	N25RRC	228	N30HM1SSN	246
N15PRES	271	N21CCG	144	N25SSC	228	N30HM1SSP	246
N15PRS	271	N21CCUC	144	N26AAC	227	N30HM2SN	246
N15RR	275	N21CCUG	144	N26BBC	227	N30HM2SP	246
N16CCY	282	N21CUP	144	N26CCC	227	N30HM2SSN	246
N16CRY	279	N21UPH	144	N26CCCD	228	N30HM2SSP	246
N16EE	274	N22HMA	448	N26DDC	229	N30HM3SN	247
N16EES	274	N22HMAB	448	N26DDCD	229	N30HM3SP	247
N16ER	271	N22HMM	454	N26DDCX	231	N30HM3SSN	247
N16ERS	271	N23AAC	222	N26DDCXD	232	N30HM3SSP	247
N16HH	274	N23AACY	226	N26EEC	227	N30HM8SN	247
N16HHS	274	N23BBC	222	N26EECD	228	N30HM8SSN	247
N16HR	271	N23BBCY	226	N26HHC	229	N30HM9SN	247
N16HRS	271	N23CCC	222	N26HHCD	229	N30HM9SP	247
N16JJY	282	N23CCCD	223	N26JJC	227	N30HM9SSN	247
N16JRY	280	N23CCCY	226	N26KKC	229	N30HM9SSP	247
N16MM	274	N23CCCYD	226	N26KKCX	232	N30HML1SN	246
N16MMS	274	N23DDC	224	N26MMC	227	N30HML1SP	246
N16MR	272	N23DDCD	225	N26PPC	229	N30HML1SSN	246
N16MRS	272	N23EEC	222	N26RRC	228	N30HML1SSP	246
N16PP	274	N23EECD	223	N26SSC	228	N30HML2SN	246
N16PPS	274	N23EECY	226	N30GM1PN	256	N30HML2SP	246
N16PR	272	N23EECYD	226	N30GM1PNC	256	N30HML2SSN	246
N16PRS	272	N23HHC	224	N30GM1PP	256	N30HML2SSP	246
N17AAY	284	N23HHCD	225	N30GM1PPC	256	N30HML3SN	247
N17ARY	283	N23JJC	223	N30GM1UN	256	N30HML3SP	247
N17CCY	284	N23KKC	225	N30GM1UNC	256	N30HML3SSN	247
N17CRY	283	N23MMC	223	N30GM1UP	256	N30HML3SSP	247
N17EE	277	N23PPC	225	N30GM1UPC	256	N30HML8SN	247
N17EES	277	N23RRC	224	N30GM9PN	256	N30HML8SSN	247

Model	Page	Model	Page	Model	Page	Model	Page
N30HML9SN	247	N30MU8SSN	252	N32JJMB	337	N32SJJML	347
N30HML9SP	247	N30MU9SN	252	N32JJMBS	337	N32SJJMLS	347
N30HML9SSN	247	N30MU9SP	252	N32JJJML	337	N32SJJMR	347
N30HML9SSP	247	N30MU9SSN	252	N32JJJMLS	337	N32SJJMRS	347
N30HP1SN	248	N30MU9SSP	252	N32JJMR	337	N32SJJWB	347
N30HP1SP	248	N30SP1SN	253	N32JJMRS	337	N32SJJWBS	347
N30HP1SSN	248	N30SP1SNG	253	N32JJWB	337	N32SJJWL	347
N30HP1SSP	248	N30SP1SP	253	N32JJWBS	337	N32SJJWLS	347
N30HP2SN	248	N30SP1SPG	253	N32JJWL	337	N32SJJWR	347
N30HP2SP	248	N30SP2SN	253	N32JJWLS	337	N32SJJWRS	347
N30HP2SSN	248	N30SP2SNG	253	N32JJWR	337	N32SLLM	348
N30HP2SSP	248	N30SP2SP	253	N32JJWRS	337	N32SLLMS	348
N30HP3SN	249	N30SP2SPG	253	N32KKC	352	N32SLLW	348
N30HP3SP	249	N30SP3SN	254	N32KKM	352	N32SLLWS	348
N30HP3SSN	249	N30SP3SNG	254	N32KKW	352	N32SMAAM	350
N30HP3SSP	249	N30SP3SP	254	N32LKM	352	N32SMAAW	350
N30HP8SN	250	N30SP3SPG	254	N32LKW	352	N32SMBBM	350
N30HP8SSN	250	N30SP8SN	255	N32LLM	338	N32SMBBW	350
N30HP9SN	249	N30SP8SNG	255	N32LLMS	338	N32SMHHM	351
N30HP9SP	249	N30SP9SN	255	N32LLW	338	N32SMHHW	351
N30HP9SSN	249	N30SP9SNG	255	N32LLWS	338	N32SMLLM	351
N30HP9SSP	249	N30SP9SP	255	N32MAAM	340	N32SMLLW	351
N30HU1SN	248	N30SP9SPG	255	N32MAAW	340	N32SMMMB	349
N30HU1SP	248	N30SU1SN	253	N32MABB	340	N32SMMMBS	349
N30HU1SSN	248	N30SU1SNG	253	N32MABBW	340	N32SMMMML	349
N30HU1SSP	248	N30SU1SP	253	N32MHHM	341	N32SMMMLS	349
N30HU2SN	248	N30SU1SPG	253	N32MHHW	341	N32SMMMRR	349
N30HU2SP	248	N30SU2SN	253	N32MLLM	341	N32SMMMRS	349
N30HU2SSN	248	N30SU2SNG	253	N32MLLW	341	N32SMMWB	349
N30HU2SSP	248	N30SU2SP	253	N32MMMB	339	N32SMMWBS	349
N30HU3SN	249	N30SU2SPG	253	N32MMMBS	339	N32SMMWL	349
N30HU3SP	249	N30SU3SN	254	N32MMML	339	N32SMMWLS	349
N30HU3SSN	249	N30SU3SNG	254	N32MMMLS	339	N32SMMWR	349
N30HU3SSP	249	N30SU3SP	254	N32MMMR	339	N32SMMWRS	349
N30HU8SN	250	N30SU3SPG	254	N32MMMRS	339	N32STAAW	350
N30HU8SSN	250	N30SU8SN	255	N32MMWB	339	N32STHHW	351
N30HU9SN	249	N30SU8SNG	255	N32MMWBS	339	N32STLLW	351
N30HU9SP	249	N30SU9SN	255	N32MMWL	339	N32T2424ENL	353
N30HU9SSN	249	N30SU9SNG	255	N32MMWLS	339	N32T2424ENW	353
N30HU9SSP	249	N30SU9SP	255	N32MMWR	339	N32T2448MGL	353
N30MP1SN	250	N30SU9SPG	255	N32MMWRS	339	N32T2448MGW	353
N30MP1SP	250	N32AAM	332	N32SAAM	342	N32T24ENL	353
N30MP1SSN	250	N32AAMS	332	N32SAAMS	342	N32T24ENW	353
N30MP1SSP	250	N32AAW	332	N32SAAW	342	N32T3636MGL	354
N30MP2SN	251	N32AAWS	332	N32SAAWS	342	N32T3636MGW	354
N30MP2SP	251	N32BBM	333	N32SBBM	343	N32T36MGL	354
N30MP2SSN	251	N32BBMS	333	N32SBBMS	343	N32T36MGW	354
N30MP2SSP	251	N32BBW	333	N32SBBW	343	N32TAAW	340
N30MP3SN	251	N32BBWS	333	N32SBBWS	343	N32THHW	341
N30MP3SP	251	N32CCML	334	N32SCCML	344	N32TLLW	341
N30MP3SSN	251	N32CCMLS	334	N32SCCMLS	344	N35AAC	212
N30MP3SSP	251	N32CCMR	334	N32SCCMR	344	N35AACS	212
N30MP8SN	252	N32CCMRS	334	N32SCCMRS	344	N35ABC	212
N30MP8SSN	252	N32CCWL	334	N32SCCWL	344	N35ABCS	212
N30MP9SN	252	N32CCWLS	334	N32SCCWLS	344	N35ACC	212
N30MP9SP	252	N32CCWR	334	N32SCCWR	344	N35ACCD	214
N30MP9SSN	252	N32CCWRS	334	N32SCCWRS	344	N35ACCDSD	214
N30MP9SSP	252	N32DDML	335	N32SDDML	345	N35ACCS	212
N30MU1SN	250	N32DDMLS	335	N32SDDMLS	345	N35AEC	212
N30MU1SP	250	N32DDMR	335	N32SDDMR	345	N35AECD	214
N30MU1SSN	250	N32DDMRS	335	N32SDDMRS	345	N35AECDSD	214
N30MU1SSP	250	N32DDWL	335	N32SDDWL	345	N35AECS	212
N30MU2SN	251	N32DDWLS	335	N32SDDWLS	345	N35AJC	213
N30MU2SP	251	N32DDWR	335	N32SDDWR	345	N35AJCS	213
N30MU2SSN	251	N32DDWRS	335	N32SDDWRS	345	N35AMC	213
N30MU2SSP	251	N32HHM	336	N32SHHM	346	N35AMCS	213
N30MU3SN	251	N32HHMS	336	N32SHHMS	346	N35AOC	213
N30MU3SP	251	N32HHW	336	N32SHHW	346	N35AOCDD	214
N30MU3SSN	251	N32HHWS	336	N32SHHWS	346	N35AOCDS	214
N30MU3SSP	251	N32HKM	352	N32SJJMB	347	N35AOCSD	213
N30MU8SN	252	N32HKW	352	N32SJJMBS	347	N35APC	213

Index

Model	Page	Model	Page	Model	Page	Model	Page
N35APCD	214	N44GM1WBL	236	N55AA	48	N60SDWC	399
N35APCDS	214	N44GM1WGR	236	N55BB	49	N60SEE	404
N35APCS	213	N44GM1WIM	236	N55CC	49	N60SEEW	405
N35ASC	213	N44GM1WWH	236	N55DD	49	N60SEM	400
N35ASCS	213	N44SM2W793	237	N55EE	48	N60SEMWW	402
N35ATC	213	N44SM2WBL	237	N55HH	49	N60SFA	408
N35ATCS	213	N44SM2WGR	237	N59AA	38	N60SFAW	409
N35BAC	209	N44SM2WIM	237	N59AAT	38	N60SFB	408
N35BACS	209	N44SM2WWH	237	N59AL	41	N60SFBW	409
N35BBC	209	N45AP	66	N59BB	39	N60SFC	408
N35BBCS	209	N45APR	66	N59BBT	39	N60SFCW	409
N35BCC	209	N45AU	66	N59BL	42	N60SFD	408
N35BCCD	211	N45AUR	66	N59CC	39	N60SFDW	409
N35BCCDS	211	N45BK	67	N59CCT	39	N60SGG	406
N35BCCS	209	N45BKR	67	N59CL	43	N60SGGW	407
N35BEC	209	N45BP	66	N59DD	38	N60SGL	412
N35BECD	211	N45BPR	66	N59DDT	38	N60SGM	401
N35BECDs	211	N45BU	66	N59DL	41	N60SGMW	403
N35BECS	209	N45BUR	66	N59HH	40	N60SGW	412
N35BJC	209	N45CP	68	N59HHT	40	N60SHL	412
N35BJCS	209	N45CU	68	N59HL	43	N60SHW	412
N35BMC	209	N45GB	69	N59JJ	39	N60SJ	413
N35BMCS	209	N45HP	72	N59JJT	39	N60SKL	412
N35BOC	210	N45HPL	72	N59JL	42	N60SKW	412
N35BOCD	211	N45HU	72	N59KK	41	N60SL	413
N35BOCDS	211	N45HUL	72	N59KKT	41	N60SPM	400
N35BOCS	210	N45JP	73	N59MM	40	N60SPMW	402
N35BPC	210	N45JPL	73	N59MMT	40	N60SPP	404
N35BPCD	211	N45JU	73	N59PP	40	N60SPPW	405
N35BPCDS	211	N45JUL	73	N59PPT	40	N60SRM	401
N35BPCS	210	N45K2B	76	N60AA	394	N60SRMW	403
N35BSC	210	N45K2P	76	N60AW	396	N60SRR	406
N35BSCS	210	N45K3B	76	N60BB	394	N60SRRW	407
N35BTC	210	N45K3P	76	N60BW	396	N60STA	410
N35BTCS	210	N45K4B	77	N60CC	395	N60STAW	411
N35CAC	206	N45K4P	77	N60CW	397	N60STB	410
N35CBC	206	N45K5B	77	N60DD	395	N60STBW	411
N35CCC	206	N45K5P	77	N60DO	413	N60STC	410
N35CCCD	208	N45LT	67	N60DW	397	N60STCW	411
N35CEC	206	N45LT2	67	N60EE	404	N60STD	410
N35CECD	208	N45LT2R	67	N60EM	400	N60STDW	411
N35CJC	207	N45LTR	67	N60EMW	402	N65AAA	61
N35CMC	207	N45MA	67	N60EW	405	N65AAP	61
N35COC	207	N45MAR	67	N60GB	413	N65AASA	61
N35COCD	208	N45MBB	79	N60GG	406	N65AASP	61
N35CPC	207	N45MBP	79	N60GM	401	N65BBA	61
N35CPCD	208	N45MCB	79	N60GMW	403	N65BBP	61
N35CSC	207	N45MCP	79	N60GW	407	N65BBSA	61
N35CTC	207	N45MM	67	N60PM	400	N65BBSP	61
N35EAC	215	N45MMR	67	N60PMW	402	N65CCA	60
N35EBC	215	N45P1	78	N60PP	404	N65CCP	60
N35ECC	215	N45P2	78	N60PW	405	N65CCSA	60
N35ECCD	215	N45P3	78	N60RM	401	N65CCSP	60
N35EEC	215	N45RT	67	N60RMW	403	N65DDA	60
N35EECD	215	N45RT2	67	N60RR	406	N65DDP	60
N35JAC	217	N45RT2R	67	N60RW	407	N65DDSA	60
N35JCC	217	N45RTR	67	N60SAA	394	N65DDSP	60
N35MAC	216	N45TAB	79	N60SAAC	398	N65EEA	62
N35MBC	216	N45TAP	79	N60SAW	396	N65EEP	62
N36G4M	122	N45TB	79	N60SAWC	399	N65GGA	62
N36GM	122	N45TD	69	N60SBB	394	N65GGP	62
N36S2M	122	N45TP	79	N60SBBC	398	N65HHA	62
N36SM	122	N45U1	78	N60SBW	396	N65HHP	62
N36TD	122	N45U2	78	N60SBWC	399	N66RD16C	452
N44GA1W793	237	N45U3	78	N60SCC	395	N66RD16G	452
N44GA1WBL	237	N48GFA	118	N60SCCC	398	N66RD18C	452
N44GA1WGR	237	N48GFM	118	N60SCW	397	N66RD18G	452
N44GA1WIM	237	N52GHA	242	N60SCWC	399	N66RD22C	453
N44GA1WWH	237	N52GHAC	242	N60SDD	395	N66RD22G	453
N44GB	237	N52GHM	242	N60SDDC	398	N66SQ16C	453
N44GM1W793	236	N52GHMC	242	N60SDW	397	N66SQ16G	453

Model	Page	Model	Page	Model	Page	Model	Page
N66SQ18C	453	N78LAAAUL	95	N85LBT	132	N92H2BR	156
N66SQ18G	453	N78LAAAUR	95	N85LC	133	N92H2L	157
N66SQ22C	454	N78LAAAW	94	N85LCT	133	N92H2LH	157
N66SQ22G	454	N78LAAAWB	95	N85LD	133	N92H2LL	157
N66TZ16C	455	N78LAAAWL	95	N85LDT	133	N92H2LM	157
N66TZ16G	455	N78LAAAWR	95	N85SA	126	N92H2M	156, 202
N66TZ18C	455	N78LAAU	92	N85SAA	128	N92H2R	157
N66TZ18G	455	N78LAAUB	93	N85SAAA	128	N92H2RH	157
N66TZ22C	455	N78LAAUL	93	N85SAAAT	128	N92H2RM	157
N66TZ22G	455	N78LAAUR	93	N85SAAT	128	N92H2RR	157
N67AAC	264	N78LAAW	92	N85SACA	129	N92H3B	160
N67BBC	264	N78LAAWB	93	N85SACAT	129	N92H3BB	160
N67BBCJ	264	N78LAAWL	93	N85SAT	126	N92H3BH	160
N67CCC	264	N78LAAWR	93	N85SB	126	N92H3BL	160
N67DDC	264	N78LAU	86	N85SBT	126	N92H3BM	160
N67DDCJ	264	N78LAUL	87	N85SC	127	N92H3BR	160
N67EE	264	N78LAUR	87	N85SCT	127	N92H3L	161
N68AAC	265	N78LAW	86	N85SE	127	N92H3LH	161
N68BBC	265	N78LAWL	87	N85SET	127	N92H3LL	161
N68BBCJ	265	N78LAWR	87	N85SG	129	N92H3LM	161
N68CCC	265	N78LBU	88	N85SGLW	129	N92H3M	160
N68DDC	265	N78LBUB	89	N85SH	129	N92H3R	161
N68DDCJ	265	N78LBUL	89	N85SHLW	129	N92H3RH	161
N68EE	265	N78LBUR	89	N85SJ	127	N92H3RM	161
N69AAC	266	N78LBW	88	N88GB	443	N92H3RR	161
N69BBC	266	N78LBWB	89	N88GL	443	N92HC2	162
N69BBCJ	266	N78LBWL	89	N90AA	312	N92HC3	163
N69CCC	266	N78LBWR	89	N90AAP	315	N92HIN9	167
N69DDC	266	N78LCU	90	N90AAX	313	N92H0U9	167
N69DDCJ	266	N78LCUB	91	N90BB	312	N92HSQ9D	165
N69EE	266	N78LCUL	91	N90BBP	315	N92HSQ9L	165
N75BAC	358	N78LCUR	91	N90BBX	313	N92HSQ9R	165
N75BBC	359	N78LCW	90	N90CC	312	N92HTL2B	176
N75BCC	358	N78LCWB	91	N90CCP	316	N92HTL2BB	176
N75BDC	359	N78LCWL	91	N90CCX	314	N92HTL2BH	176
N75SAC	358	N78LCWR	91	N92B1	168, 201	N92HTL2BL	176
N75SBC	359	N78LEU	96	N92B2	168, 202	N92HTL2BM	176
N75SCC	358	N78LEW	96	N92B3	168	N92HTL2BR	176
N75SDC	359	N78PAU	110	N92B9	167	N92HTL2L	177
N75SPC	358	N78SFAU	103	N92CSA	169	N92HTL2LH	177
N75SSC	358	N78SFAW	103	N92CSAC	169	N92HTL2LL	177
N75WS	359	N78SFMU	103	N92CSAL	169	N92HTL2LM	177
N78AFLAU	104	N78SFMW	103	N92CSALC	169	N92HTL2M	176
N78AFLAW	104	N78SML	97	N92CSAR	169	N92HTL2R	177
N78AFLMU	105	N78SMW	97	N92CSARC	169	N92HTL2RH	177
N78AFLMW	105	N78SNL	97	N92CSLL	169	N92HTL2RM	177
N78AFRAU	104	N78SNW	97	N92CSLLC	169	N92HTL2RR	177
N78AFRAW	104	N78T2AU	106	N92CSM	169	N92HTL3B	180
N78AFRMU	105	N78T2AW	106	N92CSMC	169	N92HTL3BB	180
N78AFRMW	105	N78T3AU	108	N92CSRRC	169	N92HTL3BH	180
N78B2AU	107	N78T3AW	108	N92CSRRC	169	N92HTL3BL	180
N78B2AW	107	N78TCL	112	N92GB2	169	N92HTL3BM	180
N78B2EU	107	N78TCW	112	N92H1B	152	N92HTL3BR	180
N78B2EW	107	N78TEL	112	N92H1BH	152	N92HTL3L	181
N78B3AU	109	N78TEW	112	N92H1BL	152	N92HTL3LH	181
N78B3AW	109	N78TNL	112	N92H1BM	152	N92HTL3LL	181
N78B3EU	109	N78TNW	112	N92H1BR	152	N92HTL3LM	181
N78B3EW	109	N79AAC	326	N92H1L	153	N92HTL3M	180
N78D1M	111	N79AACJ	326	N92H1LH	153	N92HTL3R	181
N78D2A	111	N79AACX	327	N92H1LL	153, 202	N92HTL3RH	181
N78D2M	111	N79BBC	326	N92H1LM	153	N92HTL3RM	181
N78D3A	111	N79BBCJ	326	N92H1M	152	N92HTL3RR	181
N78D3M	111	N79BBCX	327	N92H1R	153	N92HTLC2	182
N78GEAU	110	N79CC	326	N92H1RH	153	N92HTLC3	183
N78GEAW	110	N80AA	364	N92H1RM	153	N92HTLIN9	187
N78GFAU	102	N80BB	364	N92H1RR	153, 202	N92HTLSQ9D	185
N78GFAW	102	N85CAC	138	N92H2B	156	N92HTLSQ9L	185
N78GFMU	102	N85CBC	138	N92H2BB	156	N92HTLSQ9R	185
N78GFMW	102	N85LA	132	N92H2BH	156	N92HTU2B	176
N78LAAAU	94	N85LAT	132	N92H2BL	156	N92HTU2BB	176
N78LAAAU	95	N85LB	132	N92H2BM	156	N92HTU2BH	176

Index

Model	Page	Model	Page	Model	Page	Model	Page
N92HTU2BL	176	N92M1BM	150	N92MTU2BB	174	N92THIB18L	193
N92HTU2BM	176	N92M1BR	150	N92MTU2BL	174	N92THIB18LW	193
N92HTU2BR	176	N92M1L	151	N92MTU2BM	174	N92THIB18W	193
N92HTU2L	177	N92M1LL	151	N92MTU2BR	174	N92THIB18WW	193
N92HTU2LH	177	N92M1LM	151	N92MTU2L	175	N92THIB27L	193
N92HTU2LL	177	N92M1M	150, 201-202	N92MTU2LL	175	N92THIB27LW	193
N92HTU2LM	177	N92M1R	151	N92MTU2LM	175	N92THIB27W	193
N92HTU2M	176	N92M1RM	151	N92MTU2M	174	N92THIB27WW	193
N92HTU2R	177	N92M1RR	151	N92MTU2R	175	N92THIBL	191, 202
N92HTU2RH	177	N92M2B	154	N92MTU2RM	175	N92THIBLW	191
N92HTU2RM	177	N92M2BB	154	N92MTU2RR	175	N92THIBS18L	195
N92HTU2RR	177	N92M2BL	154	N92MTU3B	178	N92THIBS18LW	195
N92HTU3B	180	N92M2BM	154	N92MTU3BB	178	N92THIBS18W	195
N92HTU3BB	180	N92M2BR	154	N92MTU3BL	178	N92THIBS18WW	195
N92HTU3BH	180	N92M2L	155	N92MTU3BM	178	N92THIBS27L	195
N92HTU3BL	180	N92M2LL	155	N92MTU3BR	178	N92THIBS27LW	195
N92HTU3BM	180	N92M2LM	155	N92MTU3L	179	N92THIBS27W	195
N92HTU3BR	180	N92M2M	154	N92MTU3LL	179	N92THIBS27WW	195
N92HTU3L	181	N92M2R	155	N92MTU3LM	179	N92THIBV18L	195
N92HTU3LH	181	N92M2RM	155	N92MTU3M	178, 201	N92THIBV18LW	195
N92HTU3LL	181	N92M2RR	155, 201	N92MTU3R	179	N92THIBV18W	195
N92HTU3LM	181	N92M3B	158	N92MTU3RM	179	N92THIBV18WW	195
N92HTU3M	180	N92M3BB	158	N92MTU3RR	179	N92THIBV27L	195
N92HTU3R	181	N92M3BL	158	N92MTUC2	182	N92THIBV27LW	195
N92HTU3RH	181	N92M3BM	158	N92MTUC3	183	N92THIBV27W	195
N92HTU3RM	181	N92M3BR	158	N92MTUIN9	186	N92THIBV27WW	195
N92HTU3RR	181	N92M3L	159	N92MTUSQ9D	184	N92THIBVS18L	196
N92HTUC2	182	N92M3LL	159	N92MTUSQ9L	184	N92THIBVS18LW	196
N92HTUC3	183	N92M3LM	159	N92MTUSQ9R	184, 201	N92THIBVS18W	196
N92HTUIN9	187	N92M3M	158	N92MTW2B	174	N92THIBVS18WW	196
N92HTUSQ9D	185	N92M3R	159	N92MTW2BB	174	N92THIBVS27L	196
N92HTUSQ9L	185	N92M3RM	159	N92MTW2BL	174	N92THIBVS27LW	196
N92HTUSQ9R	185	N92M3RR	159	N92MTW2BM	174	N92THIBVS27W	196
N92HTW2B	176	N92MC2	162	N92MTW2BR	174	N92THIBVS27WW	196
N92HTW2BB	176	N92MC3	163	N92MTW2L	175	N92THIBW	191
N92HTW2BH	176	N92MIN9	166	N92MTW2LL	175	N92THIBWW	191
N92HTW2BL	176	N92MOU9	166, 201	N92MTW2LM	175	N92TMCLL	191
N92HTW2BM	176	N92MSQ9D	164, 201-202	N92MTW2M	174	N92TMCLLW	191
N92HTW2BR	176	N92MSQ9L	164	N92MTW2R	175	N92TMCLW	191
N92HTW2L	177	N92MSQ9R	164	N92MTW2RM	175	N92TMCLWW	191
N92HTW2LH	177	N92MTL2B	174	N92MTW2RR	175	N92TMCRL	191
N92HTW2LL	177	N92MTL2BB	174	N92MTW3B	178	N92TMCRLW	191
N92HTW2LM	177	N92MTL2BL	174	N92MTW3BB	178	N92TMCRW	191
N92HTW2M	176	N92MTL2BM	174	N92MTW3BL	178	N92TMCRW	191
N92HTW2R	177	N92MTL2BR	174	N92MTW3BM	178	N92TMIB18L	193
N92HTW2RH	177	N92MTL2L	175	N92MTW3BR	178	N92TMIB18LW	193
N92HTW2RM	177	N92MTL2LL	175	N92MTW3L	179	N92TMIB18W	193
N92HTW2RR	177	N92MTL2LM	175	N92MTW3LL	179	N92TMIB18WW	193
N92HTW3B	180	N92MTL2M	174	N92MTW3LM	179	N92TMIB27L	193
N92HTW3BB	180	N92MTL2R	175	N92MTW3M	178	N92TMIB27LW	193
N92HTW3BH	180	N92MTL2RM	175	N92MTW3R	179	N92TMIB27W	193
N92HTW3BL	180	N92MTL2RR	175	N92MTW3RM	179	N92TMIB27WW	193
N92HTW3BM	180	N92MTL3B	178	N92MTW3RR	179	N92TMIBL	190
N92HTW3BR	180	N92MTL3BB	178	N92MTWC2	182	N92TMIBLW	190
N92HTW3L	181	N92MTL3BL	178	N92MTWC3	183	N92TMIBS18L	194
N92HTW3LH	181	N92MTL3BM	178	N92MTWIN9	186	N92TMIBS18LW	194
N92HTW3LL	181	N92MTL3BR	178	N92MTWSQ9D	184	N92TMIBS18W	194
N92HTW3LM	181	N92MTL3L	179	N92MTWSQ9L	184	N92TMIBS18WW	194
N92HTW3M	180	N92MTL3LL	179	N92MTWSQ9R	184	N92TMIBS27L	194
N92HTW3R	181	N92MTL3LM	179	N92TENL	190, 201	N92TMIBS27LW	194
N92HTW3RH	181	N92MTL3M	178	N92TENLW	190	N92TMIBS27W	194
N92HTW3RM	181	N92MTL3R	179	N92TENW	190	N92TMIBS27WW	194
N92HTW3RR	181	N92MTL3RM	179	N92TENWW	190	N92TMIBW	190
N92HTWC2	182	N92MTL3RR	179	N92THCLL	192, 202	N92TMIBWW	190
N92HTWC3	183	N92MTLC2	182	N92THCLLW	192	N92TRT3048L	199
N92HTWIN9	187	N92MTLC3	183	N92THCLW	192	N92TRT3048LK	199
N92HTWSQ9D	185	N92MTLIN9	186	N92THCLWW	192	N92TRT3048S	199
N92HTWSQ9L	185	N92MTLSQ9D	184	N92THCRL	192, 202	N92TRT3048W	199
N92HTWSQ9R	185	N92MTLSQ9L	184	N92THCRLW	192	N92TRT3048WK	199
N92M1B	150	N92MTLSQ9R	184	N92THCRW	192	N92TRT3060L	197
N92M1BL	150	N92MTU2B	174	N92THCRWW	192	N92TRT3060LK	197

Model	Page	Model	Page	Model	Page	Model	Page
N92TRT3060S	197	NAC1848CUSH	435	QN22HMA	448	QN35BOCDS	211
N92TRT3060W	197	NAC1860CUSH	435	QN22HMAB	448	QN35BOCS	210
N92TRT3060WK	197	NAC1872CUSH	435	QN22HMM	448	QN35BPC	210
N92TRT3072L	199	NAC2124CUSH	435	QN25DDC	229	QN35BPCD	211
N92TRT3072LK	199	NAC2130CUSH	435	QN25DDCD	229	QN35BPCDS	211
N92TRT3072S	199	NAC2136CUSH	435	QN26DDC	229	QN35BPCS	210
N92TRT3072W	199	NAC2148CUSH	435	QN26DDCD	229	QN35BSC	210
N92TRT3072WK	199	NAC2160CUSH	435	QN30GM1UN	256	QN35BSCS	210
N92TRT3084L	197	NAC2172CUSH	435	QN30GM1UNC	256	QN35BTC	210
N92TRT3084LK	197	NAC2424CUSH	435	QN30GM9UP	256	QN35BTCS	210
N92TRT3084S	197	NAC2430CUSH	435	QN30GM9UPC	256	QN35CAC	206
N92TRT3084W	197	NAC2436CUSH	435	QN30GP9UP	257	QN35CBC	206
N92TRT3084WK	197	NAC2448CUSH	435	QN30GP9UPC	257	QN35CCC	206
N95AA	369	NAC2460CUSH	435	QN30GU1UN	258	QN35CCCD	208
N95AAC	369	NAC2472CUSH	435	QN30GU1UNC	258	QN35CEC	206
N95AAL	369	NACG122ELB	463	QN30GU9UP	259	QN35CECD	208
N95AALC	369	NACG122ELHB	463	QN30GU9UPC	259	QN35CJC	207
N95AAR	369	NACG122ELHS	463	QN30HM2SSP	246	QN35CMC	207
N95AARC	369	NACG122ELS	463	QN30HM3SSP	247	QN35COC	207
N95BB	372	NACG12ELB	463	QN30HP2SSP	248	QN35COCD	208
N95BBB	372	NACG12ELHB	463	QN30HP3SSP	249	QN35CPC	207
N95BBL	372	NACG12ELHS	463	QN30MP2SSP	251	QN35CPCD	208
N95BBR	372	NACG12ELS	463	QN30MP3SSP	251	QN35CSC	207
N95CC	374	NACG172ELB	464	QN32AAM	332	QN35CTC	207
N95CCB	375	NACG172ELS	464	QN32AAW	332	QN35EAC	215
N95CCL	375	NACG173ELB	464	QN35AAC	212	QN35EBC	215
N95CCR	375	NACG173ELS	464	QN35AACS	212	QN35ECC	215
N95DD	381, 385-386	NACG17ELB	464	QN35ABC	212	QN35ECCD	215
N95DDC	381	NACG17ELS	464	QN35ABCS	212	QN35EEC	215
N95EE	381, 386, 388	NACG23ELB	464	QN35ACC	212	QN35EECD	215
N95GG	381	NACG23ELS	464	QN35ACCD	214	QN35JAC	217
N95KKL	382	Q39U-GWXX	419	QN35ACDS	214	QN35JCC	217
N95KKW	382, 388-389	Q88X-MNFXC	442	QN35ACCS	212	QN35MAC	216
N95LLL	382	Q89X-EWECC	440	QN35AEC	212	QN35MBC	216
N95LLW	382	Q89X-GWXX	441	QN35AECD	214	QN36G4M	122
N95MA	368, 385, 387-389	Q89X-MWECC	441	QN35AECDS	214	QN36GM	122
N95MAC	368	QN12JJC	291	QN35AECS	212	QN36S2M	122
N95MAL	370	QN12JJCE	291	QN35AJC	213	QN36SM	122
N95MALT	370	QN12JJCES	291	QN35AJCS	213	QN45AP	66
N95MAR	370	QN12JJCS	291	QN35AMC	213	QN45APR	66
N95MART	370, 385	QN12MMCES	295	QN35AMCS	213	QN45AU	66
N95MB	371, 385	QN12MMCS	295	QN35AOC	213	QN45AUR	66
N95MBL	373, 385	QN12QQ	297	QN35AOCD	214	QN45BP	66
N95MBLT	373	QN12RR	297	QN35AOCDs	214	QN45BPR	66
N95MBR	373, 385	QN14QQ	301	QN35AOCS	213	QN45BU	66
N95MBRT	373	QN15MMES	273	QN35APC	213	QN45BUR	66
N95MC	374, 387	QN15MMS	273	QN35APCD	214	QN45CP	68
N95MCL	376	QN15RR	275	QN35APCDS	214	QN45CU	68
N95MCLT	376	QN17RR	277	QN35APCS	213	QN45HP	72
N95MCR	376	QN21AAC	142	QN35ASC	213	QN45HPL	72
N95MCRT	376	QN21AAG	142	QN35ASCS	213	QN45HU	72
N95MH	377, 387	QN21AATC	142	QN35ATC	213	QN45HUL	72
N95MHA	377, 387	QN21AATG	142	QN35ATCS	213	QN45JP	73
N95MJ	378, 387, 389	QN21AATUC	142	QN35BAC	209	QN45JPL	73
N95MJA	379, 387, 389	QN21AATUG	142	QN35BACS	209	QN45JU	73
N95MK	379, 385	QN21AAUC	142	QN35BBC	209	QN45JUL	73
N95MKA	380, 386, 389	QN21AAUG	142	QN35BBCS	209	QN45P1	78
N95NNL	383	QN21BBC	143	QN35BCC	209	QN45P2	78
N95NNW	383, 385-386	QN21BBG	143	QN35BCCD	211	QN45P3	78
N95PPL	383	QN21BBTC	143	QN35BCCDS	211	QN45U1	78
N95PPW	383, 386, 389	QN21BBTG	143	QN35BCCS	209	QN45U2	78
N95RRL	383	QN21BBTUC	143	QN35BEC	209	QN45U3	78
N95RRW	383	QN21BBTUG	143	QN35BECD	211	QN48GFA	118
N95SSL	383	QN21BBUC	143	QN35BECDs	211	QN48GFM	118
N95SSW	383	QN21BBUG	143	QN35BECS	209	QN52GHA	242
N95TR	384	QN21CCC	144	QN35BJC	209	QN52GHAC	242
N95TT	384-389	QN21CCG	144	QN35BJCS	209	QN52GHM	242
N95TU	384	QN21CCUC	144	QN35BMC	209	QN52GHMC	242
NAC1824CUSH	435	QN21CCUG	144	QN35BMCS	209	QN55AA	48
NAC1830CUSH	435	QN21CUP	144	QN35BOC	210	QN59AA	38
NAC1836CUSH	435	QN21UPH	144	QN35BOCD	211	QN59AL	41

Index

Model	Page	Model	Page	Model	Page	Model	Page
QN59BB	39	QN66RD16G	452	QN66TZ16G	455	QN78GFMU	102
QN59BL	42	QN66RD18C	452	QN66TZ18C	455	QN78GFMW	102
QN60AA	394	QN66RD18G	452	QN66TZ18G	455	QN79AAC	326
QN60BB	394	QN66RD22C	453	QN66TZ22C	455	QN79BBC	326
QN60CC	395	QN66RD22G	453	QN66TZ22G	455	QN79CC	326
QN60DD	395	QN66SQ16C	453	QN69CCC	266	QN85SA	126
QN60GB	413	QN66SQ16G	453	QN69EE	266	QN85SAA	128
QN60SAA	394	QN66SQ18C	453	QN75BAC	358	QN85SAAA	128
QN60SBB	394	QN66SQ18G	453	QN75BCC	358	QN85SB	126
QN60SCC	395	QN66SQ22C	454	QN75WS	359	QN85SG	129
QN60SDD	395	QN66SQ22G	454	QN78GFAU	102	QN85SH	129
QN66RD16C	452	QN66TZ16C	455	QN78GFAW	102	QN85SJ	127

GENERAL INFORMATION

National Seating Upholstery..... 2A
Momentum 3A
Stinson..... 5A
Alliance Program Pricing 18A
COM Yardage Requirements 20A
National TB133 Matrix 21A

SEATING

Farrah™ 7A
Grin™ 13A

NATIONAL SEATING FABRIC OFFERING

CALI – GRADE 1

79% Polyester, 21% Rayon
54" Wide
Teflon Finish; Polyester Backing
Repeat: None (Non-matched)
Cleaning Code: W
70,000 Double Rubs
Does not meet TB133

11601 Cactus	11605 Sunset	11609 Surf
11602 Beach	11606 Boardwalk	11610 Coast
11603 Sand	11607 Pier	11611 Boulder
11604 Desert	11608 Vineyard	

ACOUSTIC – GRADE J

100% Polyurethane
54" Wide
Anti-Microbial, Anti-Bacterial Finish; Polyester Backing
Repeat: 5" L x 5" W
Cleaning Code: W or 4:1 Bleach Solution
100,000 Double Rubs

9168476	Agave	9168531	Dew	9168586	Reed
9168487	Anise	9168542	Dolomite	9168597	Vapor
9168498	Ardent	9168553	Fresh	9168608	Wisp
9168509	Cork	9168564	Mudslide		
9168520	Cyprine	9168575	Pumice		

ASCEND – GRADE F

61% Repreve® Post-Consumer Recycled Polyester, 39% Polyester
56" Wide
Crypton Green® Finish; Moisture Barrier; Antimicrobial
Repeat: 6" L x 1.875" W
Cleaning Code: W or 10:1 Bleach Solution
200,000 Double Rubs

9159192	Bark	9159258	Dusk	9159357	Harvest
9159203	Calm	9159269	Evening	9159368	Maize
9159214	Coast	9159280	Flannel	9159379	Mood
9159225	Constant	9159291	Geode	9159390	Saffron
9159236	Cypress	9159335	Grain		
9159247	Dune	9159346	Grow		

BANTER – GRADE O

100% Repreve Solution Dyed Recycled Nylon
54" Wide
No Finish; Nylon Backing
Repeat: 13.75" L x 14.25" W
Cleaning Code: WS or 4:1 Bleach Solution
150,000 Double Rubs

9133243	Dune	9133276	Reflection	9133309	Stone
9133254	Henna	9133287	Sanctuary	9133375	Toffee
9133265	Pear	9133298	Sesame		

BEELINE – GRADE B

100% Polyurethane
54" Wide
Anti-Microbial, Anti-Bacterial Finish; Polyester Backing
Repeat: None
Cleaning Code: W or 4:1 Bleach Solution
500,000 Double Rubs

9125510	Canvas	9125598	Oriole	9152823	Autumn
9125521	Cork	9125609	Parade	9152834	Dune
9125532	Eclipse	9125620	Portobello	9152845	Jetty
9125543	Eucalyptus	9125631	Sisal	9152856	Lake
9125554	Forge	9125642	Sprout	9152867	Myth
9125565	Fossil	9125653	Sundance	9152878	Oat
9125576	Geyser	9125664	Tidal	9152889	Spice
9125587	Nimbus	9126357	Walnut	9152900	Valley

BEEP – GRADE H

50% Post-Consumer Recycled Polyester, 50% Polyester
54" Wide
Soil + Stain Resistant Finish; Acrylic Backing
Repeat: .625" L x 15" W
Cleaning Code: WS
70,000 Double Rubs

9155573	Bridge	9155606	Greenlight	9155639	Steel
9155584	Flax	9155617	Jet	9155650	Teak
9155595	Furnace	9155628	Pontoon	9155661	Trail

COVER CLOTH – GRADE C

56% Repreve Post-Consumer Recycled Polyester, 44% Polyester
59" Wide
Crypton Green® Finish; Moisture Barrier; Antimicrobial
Repeat: None
Cleaning Code: W or 10:1 Bleach Solution
200,000 Double Rubs

9137511	Antique	9137588	Graphite	9137665	Savor
9137522	Bouquet	9137764	Heirloom	9137676	Shire
9137533	Coffee	9137599	Hickory	9137687	Sorrel
9137544	Cyan	9137610	Indigo	9137709	Taiga
9137555	Delft	9137621	Jet	9137698	Taupe
9137566	Electric	9137632	Navel	9137720	Vesper
9137577	Flame	9137643	Oat	9137731	Vessel
9137753	Fuchsia	9137654	Platinum	9137742	Zest

FRINGE – GRADE E

100% Polyurethane
54" Wide
Anti-Microbial, Anti-Bacterial Finish; Polyester Backing
Repeat: 17" W
Cleaning Code: W or 4:1 Bleach Solution
145,000 Double Rubs

9168245	Astral	9168311	Coin	9168377	Platinum
9168256	Azurite	9168322	Daylily	9168388	Pyrite
9168267	Bonsai	9168333	Galena	9168399	Sumie
9168278	Cane	9168344	Hosta	9168410	Zing
9168289	Carob	9168355	Nordic		
9168300	Cinder	9168366	Papyrus		

LEDGE – GRADE F

69% Post-Consumer Recycled Polyester, 31% Polyester
56" Wide
Soil + Stain Resistant Finish; Acrylic Backing
Repeat: 6.5" L x 7.5" W
Cleaning Code: WS
50,000 Double Rubs

9161898	Dali	9161920	Seneca
9161909	Firenze	9161931	Verdi

SILICA CUSP – GRADE P

100% Silicone
54" Wide
No Finish; Polyester Backing
Repeat: 12.5" L x 12.375" W
Cleaning Code: WS or 4:1 Bleach Solution
500,000 Double Rubs

9172282	Amber	9172304	Java	9172326	Spa
9172293	Coir	9172315	Pier	9172337	Violet

SILICA DEFLECT – GRADE L

100% Silicone
54" Wide
No Finish; Polyester Backing
Repeat: 25" L x 13.75" W
Cleaning Code: WS or 4:1 Bleach Solution
500,000 Double Rubs

9171402	Adrift	9171424	Oat	9171446	Spruce
9171413	Gull	9171435	Shore	9171457	Wenge

MOMENTUM PROGRAM TEXTILES

SILICA ETCH – GRADE F

100% Silicone
 54" Wide
 No Finish; Polyester Backing
 Repeat: None
 Cleaning Code: WS or 4:1 Bleach Solution
 270,000 Double Rubs

9157784	Almond	9157872	Doe	9157971	Nickel
9157795	Barley	9157894	Flint	9157982	Palm
9157806	Brickberry	9157905	French	9157993	Plum
9157817	Camel	9157916	Ink	9158004	Rain
9157828	Celadon	9157927	Juniper	9158015	Sage
9157839	Chambord	9157938	Manta	9158026	Slate
9157850	Copper	9157949	Mink	9158037	Wetstone
9157861	Derby	9157960	Mustang	9158048	Wistful

SILICA HOOP – GRADE M

100% Silicone
 54" Wide
 No Finish; Polyester Backing
 Repeat: 8.125" L x 7" W
 Cleaning Code: WS or 4:1 Bleach Solution
 500,000 Double Rubs

9169389	Aloe	9169367	Cloud	9169411	Water
9169356	Chicory	9169400	Tranquil	9169378	Wisp

SILICA LEATHER – GRADE F

100% Silicone
 54" Wide
 No Finish; Polyester Backing
 Repeat: None
 Cleaning Code: WS or 4:1 Bleach Solution
 210,000 Double Rubs

9141438	Almond	9141526	Earthen	9141614	Marigold
9141449	Aloe	9141537	Eclipse	9141625	Mink
9141460	Barley	9141548	Eucalyptus	9141636	Pewter
9141471	Chambray	9141559	Hyacinth	9141647	Raisin
9141482	Denim	9141570	Ink	9141658	Rustic
9141493	Dove	9141581	Juniper	9141669	Saddle
9141504	Driftwood	9141592	Lichen	9141691	Shadow
9141515	Dune	9141603	Madder	9141702	Umber

SPAN CRYPTON – GRADE G

42% Polyester, 35% Post-Industrial Recycled Polyester,
 23% Post-Consumer Recycled Polyester
 56" Wide
 Crypton Green® Finish; Moisture Barrier; Antimicrobial
 Repeat: 1.375" L x 2.5" W
 Cleaning Code: W or 10:1 Bleach Solution
 100,000 Double Rubs

9157597	Bark	9157586	Oat	9157630	Voyage
9157608	Downtown	9157619	Resort		

SYNERGY – GRADE E

71% Post-Consumer Recycled Polyester, 29% Polyester
 53" Wide
 Crypton Green® Finish; Moisture Barrier; Antimicrobial
 Repeat: No
 Cleaning Code: W or 10:1 Bleach Solution
 165,000 Double Rubs

9154792	Aegean	9154847	Denim	9154902	Sandstone
9154803	Balsamic	9154858	Lichen	9154913	Seaglass
9154814	Barley	9154869	Meadow	9154924	Tango
9154825	Bedrock	9154880	Otter		
9154836	Carbon	9154891	Pecan		

ALIGNMENT – GRADE J

70% Post-Consumer Recycled Polyester, 30% Solution Dyed Nylon
 54" Wide
 Non-PFOA Stain Resistant Finish; Acrylic Backing
 Repeat: 4.5" H x 5.375" V
 Cleaning Codes: WS or 5:1 Bleach Solution
 100,000 Double Rubs

63920	Twist	63923	Summer	63926	Sangria
63921	Sublime	63924	Neutral	63927	Harbour
63922	Poolside	63925	Wildcard	63928	Urban

CONCENTRIC – GRADE L

44% Polyester, 38% Solution Dyed Nylon, 18% Solution Dyed Polyester
 54" Wide
 Non-PFOA Stain Resistant Finish; Acrylic Backing
 Repeat: 7.25" H x 10.5" V
 Cleaning Code: WS or 5:1 Bleach Solution
 100,000 Double Rubs

64140	Curve	64144	Radius	64148	Spiral
64141	Diameter	64145	Sphere	64149	Full Circle
64142	Roundabout	64146	Halo	64150	Outline
64143	Ring	64147	Corona		

EFFERVESCENCE – G

100% Polyurethane
 54" Wide
 Advanced Soil + Stain Resistant Top Coat, Anti-Microbial; Polyester Backing
 Repeat: 20.47" H x 20.4" V
 Cleaning Code: WS or 5:1 Bleach Solution
 100,000 Double Rubs

EFF10	New Wave	EFF14	Pomegranate	EFF18	Fuchsia
EFF11	Champagne	EFF15	Blue Fizz	EFF19	Nautical
EFF12	Spa	EFF16	Seltzer	EFF20	Incense
EFF13	Appletini	EFF17	Suede	EFF21	Root Beer

NEST – GRADE R

61% Post-Consumer Recycled Polyester, 25% Solution Dyed Nylon, 14% Post Industrial Recycled Nylon
 54" Wide
 Incase™ Finish; Acrylic Backing
 Repeat: 14.125" H x 22" V
 Cleaning Code: WS or 10:1 Bleach Solution
 70,000 Double Rubs

64090	Chanterelle	64093	Drift	64096	Truffle
64091	Tile	64094	Indigo	64097	Charcoal
64092	Citron	64095	Brick		

RETROGRADE – GRADE E

97% Polyester, 2% Post Industrial Recycled Polyester, 1% Post-Consumer Recycled Polyester
 54" Wide
 Non-PFOA Stain Resistant Finish; Acrylic Backing
 Repeat: 7.375" H x 10.75" V
 Cleaning Code: WS or 10:1 Bleach Solution
 54,000 Double Rubs

63770	Electric	63774	Coastal	63777	Aquamarine
63771	Sunrise	63775	Lava	63778	Riverside
63773	Castlerock	63776	Mercury	63779	Eclipse

SIDELINE – GRADE I

100% Post-Industrial Recycled Polyester
 54" Wide
 Non-PFOA Stain Resistant Finish; Polyester Backing
 Repeat: 13.75" V
 Cleaning Code: WS
 100,000+ Double Rubs

63345	Coconut Grove	63348	Fiesta	63351	Safari
63346	Heat Wave	63349	Crown Jewel	63352	Malibu
63347	Moon Rock	63350	Shady Lane	63353	Piano Keys

TRIBECA – GRADE B

100% Polyester
 54" Wide
 Enhanced Soil + Stain Protection Finish; Latex Backing
 Repeat: None
 Cleaning Codes: WS
 100,000 Double Rubs

63741	Dove	63747	Burnt Orange	63753	Teal
63742	Jute	63748	Cayenne	63754	Regatta
63743	Sunflower	63749	Kiss	63755	Gemstone
63744	Amber	63750	Cassis	63756	Truffle
63745	Silver	63751	Wasabi	63757	Shadow
63746	Slate	63752	Clover	63758	Caviar

VANISH – GRADE I

100% Post Industrial Recycled Solution Dyed Nylon
 54" Wide
 Non-PFOA Stain Resistant Finish; Acrylic Backing
 Repeat: 13.75" H x 11.25" V
 Cleaning Code: WS or 10:1 Bleach Solution
 100,000 Double Rubs

64110	Aspen	64112	Mixed Metals	64114	Aqua
64111	Sterling	64113	Sky	64115	Dark Chocolate

WICKER – GRADE G

100% Vinyl
 54" Wide
 Zeron® Finish, Silver Ion Anti-Microbial; Polyester Backing
 Repeat: Non-matching
 Cleaning Code: WS or 5:1 Bleach Solution
 100,000 Double Rubs

WIC_01	Safari	WIC_03	Brindled	WIC_05	Haze
WIC_02	Lake	WIC_04	Ethereal	WIC_06	Lanai

ALLIANCE PROGRAM TEXTILES

TEXTILE APPLICATION GUIDELINES

National has listed textile application guidelines for applicable models. These guidelines are intended to help educate you of certain fabric characteristics. **Please make a point to review these guidelines when ordering National seating with National fabrics, Arc-Com, Maharam, Momentum, Stinson, and Ultrafabrics fabrics.** Application of the upholstery will be depicted as on the swatch card unless otherwise instructed on the order.

ARC-COM

PATTERN	GRADE	FABRIC GUIDELINES
Analog	R	2,3
Astral	L	2
Boardwalk	E	2
Crossroads	F	none
Dynasty	G	none
Isabella	E	2
Moon Beam 2	H	none
Polished	G	1
Radius	M	2
Robotic	I	2
Santa Fe	H	none
Spot On	J	2
Tally	G	2

MAHARAM

PATTERN	GRADE	FABRIC GUIDELINES
Anagram	T	2
Bar	C	2
Blip	Q	2
Coin	B	2
Disc	C	2
Divide	C	2
Lariat	C	none
Manner	B	none
Medium	B	none
Messenger	B	none
Metric	B	none
Oblique	C	2
Pick	B	2
Pocket	L	2
Reel	M	2
Sequence	I	2
Skein	E	none
Technic	B	none
Tilt	M	2
Vestige	O	2

MOMENTUM

PATTERN	GRADE	FABRIC GUIDELINES
Acoustic	J	2
Ascend	F	2
Banter	O	2, 3
Beeline	B	None
Beep	H	2
Cover Cloth	C	1
Fringe	E	None
Ledge	F	2
Silica Cusp	P	2
Silica Defect	L	2
Silica Etch	F	None
Silica Hoop	M	2
Silica Leather	F	None
Span Crypton	G	1, 2
Synergy	E	None

STINSON

PATTERN	GRADE	FABRIC GUIDELINES
Alignment	J	2
Concentric	L	2
Effervescence	G	None
Nest	R	2
Retrograde	E	2
Sideline	I	2
Tribeca	B	None
Vanish	I	3
Wicker	G	None

ULTRAFABRICS

PATTERN	GRADE	FABRIC GUIDELINES
Brillante	B	none
Pompeii	B	none
Primera	B	none
Strada	B	none
Toscana	B	none
Ultraleather Pro	F	none

TEXTILE APPEARANCE GUIDELINES

Please note that these guidelines are here to help you have the best looking product that National can provide to you. Guidelines 1–4 are simply explanations of what you may see on your chair. We can still upholster fabrics associated with these guidelines, but you may see some of the characteristics described.

- 1 Due to thickness and or stiffness this textile may result in gathers and puckers around corners, contours and certain seams.
- 2 Patterns are considered matched directional; however, decorative stitching, tufting/buttons, seams and seat to back on corner, wedge and diagonal units may not align due to pattern configuration.
- 3 Textile with high nylon or wool content (more than 50%) may show signs of material stretch and lack of rebound when room temperatures fluctuate.
- 4 Mohair, velvet and chenille may be easily bruised or have the potential of crooked seams due to the heavy nap and flip.

TEXTILE RESTRICTION GUIDELINES

Fabrics associated with guidelines 5 and 6 prevent us from upholstering the applicable chair series.

- 5 This textile cannot be used for glue application. Potential issues could include poor adhesion quality to the mating surface, separation of the fabric face from the backing or glue bleeding through the fabric.
- 6 Thin and/or loosely woven textiles cannot be used due to potential fabric separation at the seams.

Reference www.NationalOfficeFurniture.com/Alliance for the most up-to-date fabric guidelines, grades and additional pattern/color availability.

FARRAH

**FARRAH PRODUCT SPECIFICATIONS
N71 SERIES**

BACK CONSTRUCTION

- 1¾" of polyurethane foam covers a contoured plywood frame

SEAT CONSTRUCTION (CHAIR AND BENCH)

- 2" of polyurethane foam covers a plywood frame with high tension sheet webbing for support

ARM CONSTRUCTION

- Armrest frames are wrapped with high grade polyurethane foam and slipcovered
- Arms are attached to the back and seat with mechanical fasteners

LEGS AND GLIDES

- Die cast aluminum faceted legs available in Polished Aluminum, Cinder, Platinum Metallic, Designer White and Satin Nickel Metallic
- Black nylon height adjustable glides are standard
- Soft / non-skid adjustable glides are available for an additional upcharge

CLOSURE PANELS

- Formed metal sheet panels finished in complementary leg color: Cinder, Platinum Metallic, Designer White and Satin Nickel Metallic
- When polished legs are specified, closure panels will be Platinum Metallic

UPHOLSTERY DETAIL

- Available with contrasting fabric locations; back, seat, and arms

TABLE TOP

- Veneer surfaces are 1¾" slipmatched maple (Brighton, Caramel, Honey, Natural), cherry (Amber, Autumn, Cordovan, Judicial, Mocha, Truffle), or quarter cut walnut (Almond, Portobello, Sable) veneer, and feature a standard flat wood edge or clear exposed plywood edge
- Laminate surfaces are 1¾" HPL (high pressure laminate), and feature standard 3mm PVC edge or clear exposed plywood edge
- 1¾" Corian solid surfaces feature a knife rim profile and are available in standard or matte/satin sheen

FABRIC GUIDELINES - 1, 3, 4, 6

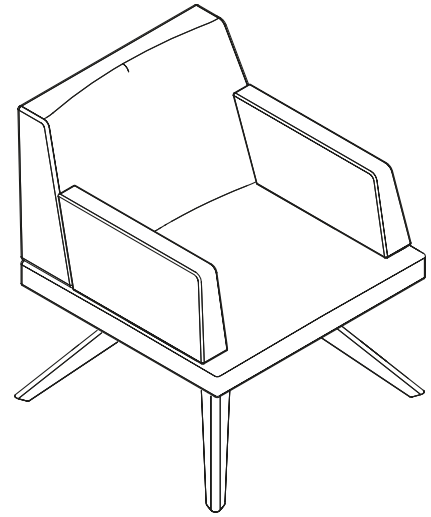

Please contact customer service for TB133 availability.

VENEER FINISHES

AC	Autumn	MH	Mocha
AD	Almond	NM	Natural
CL	Caramel	PB	Portobello
CW	Cordovan	TF	Truffle
DW	Judicial	405	Designer White
HN	Honey	462	Cinder
IM	Brighton	792	Sable
MC	Amber		

FRAME COLORS

405	Designer White
462	Cinder
497	Polished Aluminum
501	Platinum Metallic
503	Satin Nickel Metallic

**SOLID SURFACE
CORIAN COLORS**

7101	Bisque (Grade A)
7201	Glacier White (Grade B)
7301	Concrete (Grade C)
7302	Deep Night Sky (Grade C)

LAMINATE COLORS

**WOODGRAIN
LAMINATE**

AC2	Autumn 2
CL	Caramel
CW	Cordovan
DW	Judicial
HN2	Honey 2
IM	Brighton
MC	Amber
MH	Mocha
NM	Natural
TF	Truffle
791	Palisander
792	Sable
793	Acorn

**SOLID
LAMINATE**

405	Designer White
417	Mojave
418	Mouse
419	Wallaby
425	Shadow
440	Cloud
461	Graphite
462	Cinder
478	Platinum Grey
488	Frosty White
491	Designer White Linear
492	Cinder Linear

GLIDES

STD	Hard (Standard)
C57	Soft (add \$26 list)

**TOP SHEEN
OPTIONS (CORIAN)**

R	Standard
N	Matte/Satin

FARRAH

SEATING TO ORDER, SPECIFY:

1. Model Number
 2. Fabric Grade / Cover Number
 3. Frame Color
 4. Glides
- See page 9A for Farrah options

TABLES TO ORDER, SPECIFY:

1. Model Number
 2. Wood/Laminate Finish (when applicable)
 3. Corian Sheen (when applicable)
 4. Corian Grade/Color (when applicable)
 5. Frame Color (when applicable)
 6. Glides (when applicable)
- See page 9A for Farrah options

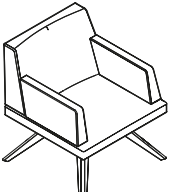
GUEST	MODEL NO.	GRADE / LIST PRICE								
		1	2/COM	3/COL	4	6	7	L7	L8	
	N71M1M	Armless	\$ 1852	1891	1910	1937	2022	2092	2427	2534
	N71M1A	Arms	2302	2350	2373	2407	2512	2598	3012	3144
	N71M1R	Right Arm	2077	2121	2142	2172	2267	2345	2719	2839
	N71M1L	Left Arm	2077	2121	2142	2172	2267	2345	2719	2839

Arms

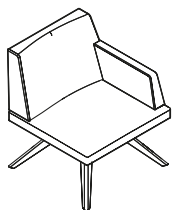

Left Arm

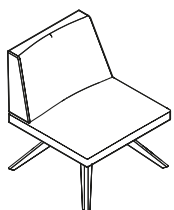

Armless

DIMENSIONS

Armless Width	26½	Seat Height	15%	Arm Height	24	Armless Weight	65
Single Arm Width	26½	Seat Depth	19%	Back Height	30%	Single Arm Weight	67
Double Arm Width	26½	Arm Seat Width	20	Back Width	20	Double Arm Weight	70
Depth	27½	Armless Seat Width	26½			Armless Cubic Ft.	14.2
Height	30%					Arm Cubic Ft.	14.2

• Contrasting fabric option – specify X (i.e., N71M1MX). For list pricing, use your electronic specification tool or contact customer service

TO ORDER CONTRASTING FABRIC, SPECIFY:

1. Model Number plus "X"
2. Back Fabric Grade Number/Cover Number
3. Seat Fabric Grade Number/Cover Number
4. Arm Fabric Grade Number/Cover Number (when applicable)
5. Frame Color
6. Glides

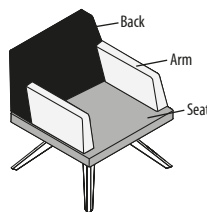

Contrasting Upholstery

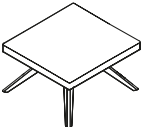
BENCH	MODEL NO.	GRADE / LIST PRICE								
		1	2/COM	3/COL	4	6	7	L7	L8	
	N71D1	Single Seat Bench	\$ 1552	1577	1589	1607	1662	1707	1924	1993

DIMENSIONS

Width	26½	Weight	63
Depth	25	Cubic Ft.	13.5
Height	15%		

END TABLE

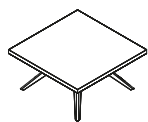

MODEL NO.

GRADE / LIST PRICE

		GRADE A	GRADE B	GRADE C
N71T2525ENL	Laminate	\$ 1300		
N71T2525ENDLW	Laminate - Exposed Plywood Rim	1450		
N71T2525ENW	Veneer	1550		
N71T2525ENDW	Veneer - Exposed Plywood Rim	1700		
N71T2525ENS	Corian Solid Surface	2175	2279	2418

DIMENSIONS

Width	25	Weight	64
Depth	25	Weight - Corian	71
Height	14	Cubic Ft.	10.4

MAGAZINE TABLE

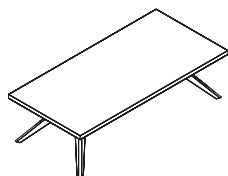

		GRADE A	GRADE B	GRADE C
N71T2552MGL	Laminate	\$ 1700		
N71T2552MGDLW	Laminate - Exposed Plywood Rim	1850		
N71T2552MGW	Veneer	1950		
N71T2552MGDW	Veneer - Exposed Plywood Rim	2100		
N71T2552MGS	Corian Solid Surface	2900	3115	3401

DIMENSIONS

Width	51½	Weight	112
Depth	24½	Weight - Corian	126
Height	14	Cubic Ft.	19.7

GANGING CENTER TABLE

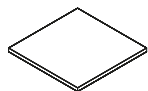

		GRADE A	GRADE B	GRADE C
N71TCL	Laminate	\$ 400		
N71TCDLW	Laminate - Exposed Plywood Rim	450		
N71TCW	Veneer	650		
N71TCDW	Veneer - Exposed Plywood Rim	700		
N71TCS	Corian Solid Surface	1200	1304	1443

DIMENSIONS

Width	25	Weight	24.5
Depth	25	Weight - Corian	31.5
Height (attached to chairs)	14	Cubic Ft.	1.5

- Two metal attachment brackets and hardware included

GRIN

GRIN

GRIN PRODUCT SPECIFICATIONS N49 SERIES

FRAME CONSTRUCTION

- 2⁵/₃₂" welded, polished, tubular steel

SEAT AND BACK CONSTRUCTION

- 1/2" molded plywood, cross banded for strength, forms seat and back
- 1 1/4" of high grade polyurethane foam covers seat and back

CONTROL MECHANISM

- Polished aluminum control mechanism and cylinder
- Static model features 360 degree swivel with auto-return
- Mobile model features 360 degree swivel

BASE, CASTERS AND GLIDES

- Four-prong polished aluminum base
- Black, hard double wheel casters, which work on multiple surfaces, are standard
- Soft casters are available for an additional upcharge
- Black polyethylene glides with a clear base are standard and work on all floors, sled base model
- Silver polyethylene glides are standard and work on all floors, swivel base model
- Felt glides are available for an upcharge, swivel base model

UPHOLSTERY DETAIL

- Contrasting fabric available on all models
- Due to stitch detail and dimensional design of the back and seat, horizontal stripes and large patterns are not recommended, as they will appear distorted or wavy across the back and seat
- Due to the inherent characteristics of certain upholstery materials, loose comfort wrinkles may be present or appear over time, especially with non-stretch vinyls and upholsteries

FABRIC GUIDELINES - 1, 3, 4, 5, 6

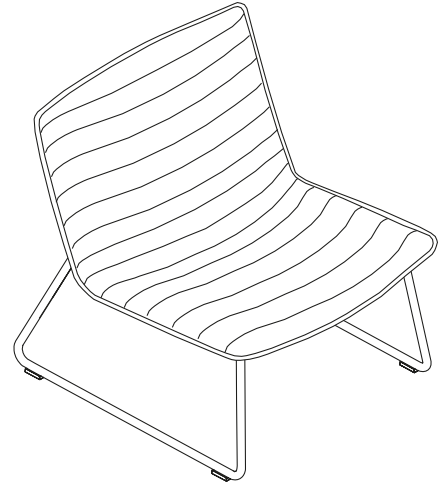

Please contact customer service for TB133 availability.

CASTERS

4-STAR BASE

- C3 Hard (Standard)
- C4 Soft (add \$26 list)

GLIDES

4-STAR BASE

- STD Hard (Standard)
- C58 Soft (add \$26 list)

**STANDARD MODEL
TO ORDER, SPECIFY:**

1. Model Number
 2. Fabric Grade / Cover Number
 3. Casters/Glides (when applicable)
- See page 15A for Grin options

**CONTRASTING PIPING MODEL
TO ORDER, SPECIFY:**

1. Model Number
 2. Fabric Grade / Cover Number
 3. Piping Fabric Grade/ Cover Number
 4. Casters/Glides (when applicable)
- See page 15A for Grin options

To You In 10 DAYS...or Less
Shaded model numbers are available on our "To You in 10 Days or Less" Quick Delivery program and will be delivered within 10 days.

SLED BASE

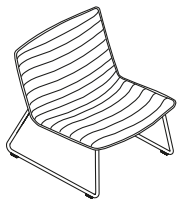

MODEL NO.

GRADE / LIST PRICE

Quick Delivery Model: QN49GMD1

	1	2/COM	3/COL	4	6	7	L7	L8
N49GMD1	\$ 1200	1251	1275	1310	1420	1510	1944	2082

DIMENSIONS

Width	27	Seat Height	13¾	Back Height	19¾	Weight	35
Depth	31	Seat Depth	20½	Back Width	27	Cubic Ft.	22.9
Height	30	Seat Width	27				

- Contrasting fabric option - specify X (i.e. N49GMD1X). For list pricing, use your electronic specification tool or contact customer service
- The front back and welt cord will be the same fabric when the contrasting option is selected
- Due to stitch detail and dimensional design of the back and seat, horizontal stripes and large patterns are not recommended, as they will appear distorted or wavy across the back and seat
- Due to the inherent characteristics of certain upholstery materials, loose comfort wrinkles may be present or appear over time, especially with non-stretch vinyls and upholsteries
- Sled base model seat height is 1¾" -2" lower than the swivel base model

**FOUR STAR
SWIVEL BASE**



Static



Mobile

Quick Delivery Model: QN49GMS1

	1	2/COM	3/COL	4	6	7	L7	L8
N49GMS1 Static	\$ 1200	1251	1275	1310	1420	1510	1944	2082
N49GMS1 Mobile	1200	1248	1273	1308	1413	1501	1922	2056

DIMENSIONS

Width	27	Seat Height - Static	15½	Back Height	19¾	Weight	34
Depth	28	Seat Height - Mobile	15¾	Back Width	27	Cubic Ft.	22.9
Height - Static	31¾	Seat Depth	20½				
Height - Mobile	32	Seat Width	27				

- Contrasting fabric option – specify X (i.e., N49GMS1X). For list pricing, use your electronic specification tool or contact customer service
- The front back and welt cord will be the same fabric when the contrasting option is selected
- Due to stitch detail and dimensional design of the back and seat, horizontal stripes and large patterns are not recommended, as they will appear distorted or wavy across the back and seat
- Due to the inherent characteristics of certain upholstery materials, loose comfort wrinkles may be present or appear over time, especially with non-stretch vinyls and upholsteries
- Swivel base model seat height is 1¾" -2" higher than the sled base model

TO ORDER CONTRASTING FABRIC, SPECIFY:

1. Model Number plus "X"
2. Front Back/Welt Cord Fabric Grade Number/Cover Number
3. Extreme Back Fabric Grade Number/Cover Number
4. Casters/Glides (when applicable)

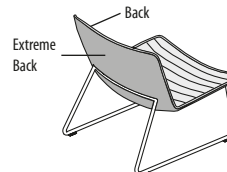

Contrasting Fabric Back View

**SLED BASE
CONTRASTING PIPING**

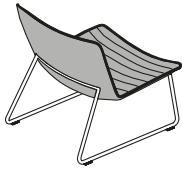

**MODEL
NO.**

GRADE / LIST PRICE

		Piping Grade 1	Piping Grade 2	Piping Grade 3	Piping Grade 4	Piping Grade 6	Piping Grade 7	Piping Grade L7	Piping Grade L8
N49GMD1P	Fabric Grade 1	\$ 1225	1232	1235	1240	1255	1267	1326	1345
	Fabric Grade 2	1276	1283	1286	1291	1306	1318	1377	1396
	Fabric Grade 3	1300	1307	1310	1315	1330	1342	1401	1420
	Fabric Grade 4	1335	1342	1345	1350	1365	1377	1436	1455
	Fabric Grade 6	1445	1452	1455	1460	1475	1487	1546	1565
	Fabric Grade 7	1535	1542	1545	1550	1565	1577	1636	1655
	Fabric Grade L7	1969	1976	1979	1984	1999	2011	2070	2089
	Fabric Grade L8	2107	2114	2117	2122	2137	2149	2208	2227

DIMENSIONS

Width	27	Seat Height	13¾	Back Height	19¾	Weight	35
Depth	31	Seat Depth	20½	Back Width	27	Cubic Ft.	22.9
Height	30	Seat Width	27				

- Contrasting piping is only available in National fabrics and leathers
- Due to stitch detail and dimensional design of the back and seat, horizontal stripes and large patterns are not recommended, as they will appear distorted or wavy across the back and seat
- Due to the inherent characteristics of certain upholstery materials, loose comfort wrinkles may be present or appear over time, especially with non-stretch vinyls and upholsteries
- Sled base model seat height is 1¾" -2" lower than swivel base model

**SWIVEL BASE
CONTRASTING PIPING**

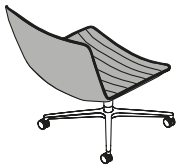

			Piping Grade 1	Piping Grade 2	Piping Grade 3	Piping Grade 4	Piping Grade 6	Piping Grade 7	Piping Grade L7	Piping Grade L8
N49GMS1P	Static	Fabric Grade 1	\$ 1225	1232	1235	1240	1255	1267	1326	1345
N49GMS1P	Mobile	Fabric Grade 2	1276	1283	1286	1291	1306	1318	1377	1396
		Fabric Grade 3	1300	1307	1310	1315	1330	1342	1401	1420
		Fabric Grade 4	1335	1342	1345	1350	1365	1377	1436	1455
		Fabric Grade 6	1445	1452	1455	1460	1475	1487	1546	1565
		Fabric Grade 7	1535	1542	1545	1550	1565	1577	1636	1655
		Fabric Grade L7	1969	1976	1979	1984	1999	2011	2070	2089
		Fabric Grade L8	2107	2114	2117	2122	2137	2149	2208	2227

DIMENSIONS

Width	27	Seat Height - Static	15½	Back Height	19¾	Weight	34
Depth	28	Seat Height - Mobile	15¾	Back Width	27	Cubic Ft.	22.9
Height - Static	31¾	Seat Depth	20½				
Height - Mobile	32	Seat Width	27				

- Contrasting piping is only available in National fabrics and leathers
- Due to stitch detail and dimensional design of the back and seat, horizontal stripes and large patterns are not recommended, as they will appear distorted or wavy across the back and seat
- Due to the inherent characteristics of certain upholstery materials, loose comfort wrinkles may be present or appear over time, especially with non-stretch vinyls and upholsteries
- Swivel base model seat height 1¾" -2" higher than sled base model

ALLIANCE PROGRAM PRICING

TO ORDER, SPECIFY THE FOLLOWING:

1. Chair Model Number
2. Fabric Grade Letter
3. Alliance Pattern Number and Color Number/Name
4. Finish Number (when applicable)

SAMPLE ORDER NUMBER

N14KK A 403901 036 HN
 \ \ \ \ \
 Model Fabric Alliance Alliance Finish
 Number Grade Pattern Color Number
 Letter Number Number

MODEL NUMBER

ALLIANCE PROGRAM PRICE GRADES

	A	B	C	D	E	F	G	H	I	J
N49GMD1	\$ 1284	\$ 1334	\$ 1378	\$ 1422	\$ 1468	\$ 1521	\$ 1559	\$ 1609	\$ 1664	\$ 1713
N49GMD1P	1309	1359	1403	1447	1493	1546	1584	1634	1689	1738
N49GMS1	1284	1334	1378	1422	1468	1521	1559	1609	1664	1713
N49GMS1P	1309	1359	1403	1447	1493	1546	1584	1634	1689	1738
N49GMSC1	1281	1330	1374	1416	1460	1512	1548	1598	1651	1697
N49GMSC1P	1306	1355	1399	1441	1485	1537	1573	1623	1676	1722
N71D1	1594	1619	1641	1663	1686	1713	1731	1757	1784	1808
N71M1A	2382	2430	2472	2514	2558	2609	2644	2693	2745	2791
N71M1L	2149	2193	2231	2269	2309	2354	2387	2430	2478	2520
N71M1M	1917	1956	1990	2024	2059	2100	2129	2168	2211	2248
N71M1R	2149	2193	2231	2269	2309	2354	2387	2430	2478	2520

ALLIANCE PROGRAM PRICING

MODEL NUMBER

ALLIANCE PROGRAM PRICE GRADES

	K	L	M	N	O	P	Q	R	S	T
N49GMD1	\$ 1794	\$ 1959	\$ 2058	\$ 2113	\$ 2166	\$ 2216	\$ 2269	\$ 2320	\$ 2373	\$ 2423
N49GMD1P	1819	1984	2083	2138	2191	2241	2294	2345	2398	2448
N49GMS1	1794	1959	2058	2113	2166	2216	2269	2320	2373	2423
N49GMS1P	1819	1984	2083	2138	2191	2241	2294	2345	2398	2448
N49GMSC1	1776	1937	2034	2087	2137	2188	2238	2287	2337	2388
N49GMSC1P	1801	1962	2059	2112	2162	2213	2263	2312	2362	2413
N71D1	1849	1932	1981	2009	2035	2060	2087	2112	2138	2164
N71M1A	2869	3027	3121	3174	3224	3272	3323	3371	3421	3470
N71M1L	2590	2733	2818	2866	2911	2955	3000	3044	3090	3133
N71M1M	2311	2439	2515	2558	2598	2637	2678	2717	2758	2797
N71M1R	2590	2733	2818	2866	2911	2955	3000	3044	3090	3133

COM YARDAGE REQUIREMENTS

COM YARDAGE

COM YARDAGE REQUIREMENTS (54" WIDTH – CUT UP THE ROLL)

MODEL	RAILROADED Contact customer service 800-482-1717 for ydg requirements	NON DIRECTIONAL OR SOLID	1"-4" REPEAT	5"-11" REPEAT	12"-18" REPEAT	COL SQUARE FEET
			4" VERTICAL X 4" HORIZONTAL	11" VERTICAL X 11" HORIZONTAL	18" VERTICAL X 18" HORIZONTAL	
N49GMD1 , N49GMS1, N49GMSC1		2.20	2.40	3.80	4.10	44
N49GMD1X , N49GMS1X, N49GMSC1X	Front Extreme	1.40 1.00	1.60 1.20	2.20 1.90	2.60 2.20	28 20
N49GMD1P , N49GMS1P, N49GMSC1P	Upholstery Piping	2.20 0.30	2.40 0.30	3.10 0.30	3.40 0.30	44 6
N71M1M		1.70	2.70	3.40	4.80	34
N71M1A		2.10	2.80	4.10	5.20	42
N71M1R, N71M1L		1.90	2.80	3.90	5.00	38
N71M1MX	Back Seat	1.10 1.10	1.30 1.70	1.50 2.60	2.30 3.20	22 22
N71M1AX	Back Seat Arm	1.10 1.10 0.90	1.30 1.70 1.00	1.50 2.60 1.70	2.30 3.20 2.70	22 22 18
N71M1RX, N71M1LX	Back Seat Arm	1.10 1.10 0.90	1.30 1.70 1.00	1.50 2.60 1.60	2.30 3.20 1.70	22 22 18
N71D1		1.10	1.70	2.60	3.20	22

NATIONAL SEATING FABRIC TB133 MATRIX

•TB133 available
 xTB133 available on select models, contact customer service for models
 †TB133 not available

		NATIONAL SEATING FABRICS																													
NATIONAL CHAIRS	GRADE	1	4	3	7	7	4	1	4	L7	4	6	6	3	2	2	1	3	7	1	6	2	2	L8	7	4	2	1	2	2	
		AMERICAN GRAFFITI	BIG CITY	BOARDWALK	BRISA	BRISA DISTRESSED	BUMBLE	CALI	CONNECT FOUR	DAVENPORT	ECHO	ESSENCE/ULTRALEATHER	FLOCK	JACKS	ORBIT	PIXIE	PLUSH	POP ROCKS	PROMESSA	RIDGE	SCRIBE	SEDONA	SHENANIGANS	SHOWCASE	SILICA	SILVERTEX	SPECTRUM	STARDUST	STRAND	TWILIGHT	
ACQUAINT	N59	•	•	•	•	•	•	†	•	•	•	•	•	•	•	•	•	•	•	•	•	•	•	•	•	•	•	•	•	•	
ADMIRE	N55	•	•	•	•	•	•	†	•	•	•	•	•	•	•	•	•	•	•	•	•	•	•	•	•	•	•	•	•	•	•
ARLINGTON	45, 48, 64, 72	•	•	•	x	x	•	†	x	•	•	x	•	•	•	•	•	x	•	x	x	•	•	•	x	•	•	•	•	•	
AURORA	N65	•	•	•	•	•	•	†	•	•	•	•	•	•	•	•	•	•	•	•	•	•	•	•	•	•	•	•	•	•	
CINCH	N45	•	•	•	•	•	•	†	•	•	•	•	•	•	•	•	•	•	•	•	•	•	•	•	•	•	•	•	•	•	
CONFIDE GUEST	N78	•	•	•	x	x	•	†	x	•	•	x	•	•	•	•	•	x	•	x	x	•	•	•	x	•	•	•	•	•	
CONFIDE LOUNGE	N78	•	•	•	†	†	•	†	†	•	†	•	•	•	•	•	•	•	†	•	†	†	•	•	†	•	•	•	•	•	
DAVARI	N48	•	•	•	•	•	•	†	•	•	•	•	•	•	•	•	•	•	•	•	•	•	•	•	•	•	•	•	•	•	
ELOQUENCE	N85	•	•	•	x	x	•	†	x	•	•	x	•	•	•	•	•	x	•	x	x	•	•	•	x	•	•	•	•	•	
FARRAH	N71	Contact customer service for availability																													
FRINGE	N92	•	•	•	†	†	•	†	†	•	•	•	•	•	•	•	•	•	•	•	•	•	•	•	•	•	•	•	•	•	
FUEL	N35	•	•	•	•	•	•	†	•	•	•	•	•	•	•	•	•	•	•	•	•	•	•	•	•	•	•	•	•	•	
GRIN	N49	Contact customer service for availability																													
JIMINY	N52	•	•	•	•	•	•	†	•	•	•	•	•	•	•	•	•	•	•	•	•	•	•	•	•	•	•	•	•	•	
LAVORO (NON-MESH)	N30	•	•	•	†	†	•	†	†	•	•	•	•	•	•	•	•	•	†	•	†	†	•	•	†	•	•	•	•	•	
MIX-IT	N12, N13, N14	•	•	†	•	•	•	†	•	•	•	•	•	•	•	•	•	•	•	•	•	•	•	•	•	•	•	•	•	•	
MIX-IT MESH	N15, N16, N17	•	•	•	•	•	•	†	•	•	•	•	•	•	•	•	•	•	•	•	•	•	•	•	•	•	•	•	•	•	
MONTERREY	N90	•	•	•	†	†	•	†	†	•	†	•	•	•	•	•	•	•	†	•	†	†	•	•	•	†	•	•	•	•	
PENNANT	62X	•	•	•	†	†	•	†	†	•	•	•	•	•	•	•	•	•	•	•	†	†	•	•	•	†	•	•	•	•	
REMEDY	N79	•	•	•	•	•	•	†	•	•	•	•	•	•	•	•	•	•	•	•	•	•	•	•	•	•	•	•	•	•	
RENO	N32	•	•	•	x	x	•	†	x	•	•	x	•	•	•	•	•	†	•	•	•	x	•	•	x	•	•	•	•	•	
RESPECT	N75	•	•	•	•	•	•	†	•	•	•	•	•	•	•	•	•	•	•	•	•	•	•	•	•	•	•	•	•	•	
SWIFT	N95	•	•	•	†	†	•	†	†	•	•	•	•	•	•	•	•	•	†	•	†	†	•	•	†	•	•	•	•	•	
TAG	N60	•	•	•	•	•	•	†	•	•	•	•	•	•	•	•	•	•	•	•	•	•	•	•	•	•	•	•	•	•	
TIMBERLANE	39	•	•	•	•	•	•	†	•	•	•	•	•	•	•	•	•	•	•	•	•	•	•	•	•	•	•	•	•	•	
TRIUMPH	88, 89	•	•	•	x	x	•	†	x	•	•	x	•	•	•	•	•	x	•	x	x	•	•	•	x	•	•	•	•	•	
WHIMSY	66	•	•	•	†	†	•	†	†	•	†	•	•	•	•	•	•	•	†	•	†	†	•	•	†	•	•	•	•	•	

TB133

NOTES

KOZMIC
COLLABORATIVE COLLECTION

KOZMIC PRODUCT SPECIFICATIONS N87 SERIES

SPINE CONSTRUCTION

- Interior frame is constructed of plywood with tenon joints
- 1" of high grade polyurethane foam covers the top of spine
- Each unit includes ganging brackets that also serves as wire management

SPINE LEGS AND GLIDES

- Aluminum legs available in polished or powder coated Cinder, Platinum Metallic or Satin Nickel Metallic
- Features a black 1½" adjustable leveling glide
- White, soft leveling glides with 1½" adjustment are available for an additional upcharge

SEAT CONSTRUCTION

- 3" of high grade polyurethane foam covers a plywood seat construction

IMPROMPTU SEATING CASTERS

- Black, 37 mm double wheel, roll control casters are standard. Casters are free rolling when sitting on unit
- Black, 50 mm double wheel, braking casters are available for an additional upcharge. Casters are non-rolling when sitting on unit
- Recommend braking casters for use on hard floors

IMPROMPTU SEATING GLIDES

- Black 1½" adjustable leveling glides are standard
- White, soft glides with 1½" adjustment are available for an additional upcharge

UPHOLSTERY DETAIL

- Contrasting fabric available on all models

TEXTILE APPLICATION GUIDELINES

- 1, 2, 3, 4, 6 - see master price list for full details

TABLES

- 1" thick worksurfaces are laminate with PVC softened rim or clear PVC exposed plywood rim
- 1" thick bistro worksurfaces are laminate with clear exposed plywood edge
- CSL option available

TABLE LEGS

- Steel rectangular legs with 2" adjustable glides available in powder coated Cinder, Platinum Metallic or Satin Nickel Metallic

POWER AND DATA GROMMET OPTION

- UL recognized
- Non-sequential "Daisy chain" solution
- Circuit 1 option allows 26 power grommets to be linked together
- Circuit 2 option allows 52 power grommets to be linked together
- Field installable
- Grommet available in white, black, light grey and dark grey
- USB grommet features two USB ports
- Power grommet features one power outlet

CUSTOMER SPECIFIED LAMINATE (CSL) PROGRAM

PROGRAM DETAILS

- National understands that some orders have specialized needs regarding laminate specifications
- In order to better service our customers, National has partnered with suppliers to offer a CSL laminate program for **HPL worksurfaces only**
- A **10% upcharge** applies to all CSL laminate orders
- National orders and procures all CSL customer specified laminates

CSL ORDERING PROCESS

- Laminate sheen level not to exceed 60° for maximum durability of worksurfaces
- Send purchase order and quantities to customer service
Please include:
 1. Manufacturer's Name
 2. Laminate Name/Laminate Number
- Lead times may vary for certain laminates and quantities, contact customer service for details

CSL POLICY

- National reserves the right to decline a laminate which may not be suitable for application
- National assumes no responsibility for the durability, consistent coloration or any other performance characteristic of a customer specified laminate

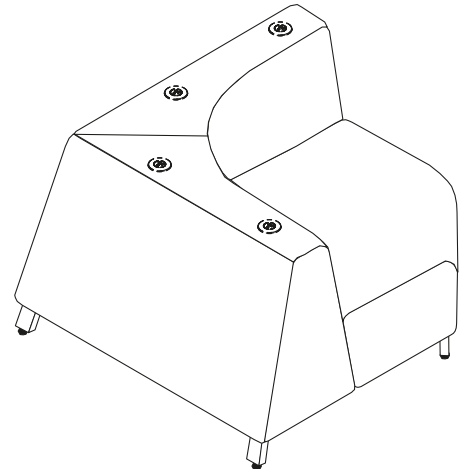

Please contact customer service for TB133 availability.

FABRICS

Grade 1	American Graffiti
	Cali
	Plush
	Ridge
	Stardust
Grade 2	COM
	Orbit
	Pixie
	Sedona
	Shenanigans
	Spectrum
	Strand
	Twilight

Grade 3	Boardwalk
	COL
	Jacks
	Pop Rocks
Grade 4	Big City
	Bumble
	Connect Four
	Echo
	Silvertex
Grade 6	Essence/Ultraleather
	Flock
	Scribe

Grade 7	Brisa
	Brisa Distressed
	Promessa
	Silica
Grade L7	Davenport
Grade L8	Showcase

LAMINATE WORKSURFACES

WOODGRAIN LAMINATE

AC2	Autumn 2
CL	Caramel
CW	Cordovan
DW	Judicial
HN2	Honey 2
IM	Brighton
MC	Amber
MH	Mocha
NM	Natural
TF	Truffle
791	Palisander
792	Sable
793	Acorn

PATTERN LAMINATE

809	Tungsten Evolv
814	White Tigris
818	Crisp Linen
819	Flax Gauze
820	Paloma Bisque
821	Elemental Concrete
822	Smoke Quarstone
874	Bronze Legacy

SOLID LAMINATE

405	Designer White
417	Mojave
418	Mouse
419	Wallaby
425	Shadow
440	Cloud
461	Graphite
462	Cinder
478	Platinum Grey
488	Frosty White
491	Designer White Linear
492	Cinder Linear

SPINE AND SEAT PAINT COLORS

265	Polished
462	Cinder
501	Platinum Metallic
503	Satin Nickel Metallic

RIM PROFILE

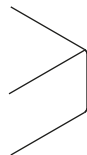

Softened PVC

PVC SOFTENED RIM

AC2	Autumn 2
CL	Caramel
CW	Cordovan
DW	Judicial
HN2	Honey 2
IM	Brighton
MC	Amber
MH	Mocha
NM	Natural
TF	Truffle
405	Designer White
417	Mojave
418	Mouse
419	Wallaby
425	Shadow
440	Cloud
461	Graphite
462	Cinder
478	Platinum Grey
488	Frosty White
491	Designer White Linear
492	Cinder Linear
791	Palisander
792	Sable
793	Acorn

CASTERS - IMPROMPTU SEATING

C59	Roll Control (standard)
C60	Braking (add \$35 list)

GLIDES

STD	Hard (standard)
C10	White Soft (add \$26 list)

GROMMET CUTOUT OPTIONS

If no grommet cutout is desired, specify an X (No Grommet)

CUTOUT OPTION FOR G32

(\$25 list upcharge per cutout)

CUT-1G32	Cutout, 1 grommet per unit
CUT-2G32	Cutout, 2 grommets per unit
CUT-3G32	Cutout, 3 grommets per unit
CUT-4G32	Cutout, 4 grommets per unit
CUT-5G32	Cutout, 5 grommets per unit

Grommets sold separately; reference page 9A for model numbers and pricing.

KOZMIC

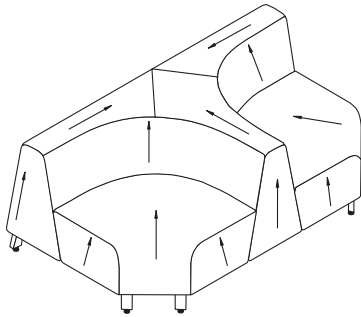

Fabric Direction

TO ORDER, SPECIFY:

1. Model Number
2. Fabric Grade / Cover Number
3. Grommet
4. Leg Paint Color
5. Glide

• See page 3A for Kozmic options

INLINE SPINE

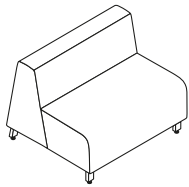
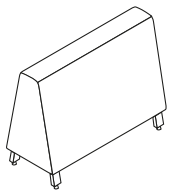

Single Seat

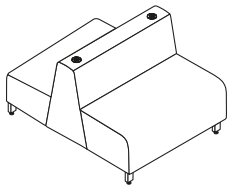

Double Seat shown with grommet option

MODEL NO.

GRADE / LIST PRICE

		1	2/COM	3/COL	4	5	6	7	L7	L8
N87AAA36	Inline Spine	\$ 950	990	1010	1038	1069	1125	1197	1542	1652
N87AS1A36	Inline Spine - Single Seat	1900	1978	2016	2070	2131	2240	2379	3049	3263
N87AS2A36	Inline Spine - Double Seat	2900	3010	3063	3140	3226	3380	3577	4522	4825

DIMENSIONS

Width	36	Seat Width	36	Cubic Ft.	10
Depth	15 $\frac{1}{4}$	Seat Depth	18	Cubic Ft. - Single Seat	18
Depth with Single Seat	31	Seat Height	16	Cubic Ft. - Double Seat	31
Depth with Double Seats	46 $\frac{3}{4}$				
Height	27 $\frac{3}{4}$				

- Contrasting fabric option - specify X (i.e. N87AAA36X): see next page. For list pricing, use your electronic specification tool or contact customer service
- Worksurfaces can be added to any spine in the field
- Ganging brackets are included with each spine
- Ganging brackets serve as wire management
- Grommet cutout option CUT-2G32 is available

T-SPINE

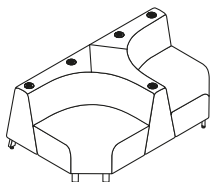
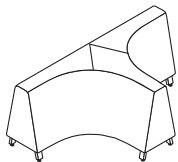

T-Spine with Seats shown with grommet option

		1	2/COM	3/COL	4	5	6	7	L7	L8
N87TA	T-Spine	\$ 2400	2490	2533	2595	2665	2790	2950	3718	3964
N87TSA	T-Spine with Seats	4800	4944	5013	5113	5225	5425	5681	6913	7306

DIMENSIONS

Width	66 $\frac{1}{4}$	Seat Height	16	Cubic Ft.	48
Depth	40 $\frac{3}{4}$			Cubic Ft. with Seats	48
Height	27 $\frac{3}{4}$				

- Contrasting fabric option - specify X (i.e. N87TAX): see next page. For list pricing, use your electronic specification tool or contact customer service
- Worksurfaces can be added to any spine in the field
- Ganging brackets are included with each spine
- Ganging brackets serve as wire management
- Grommet cutout option CUT-5G32 is available

L- SPINE

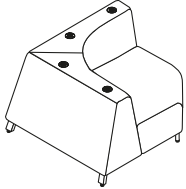
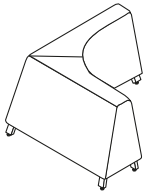

L-Spine with Seats shown with grommet option

MODEL NO.

GRADE / LIST PRICE

			1	2/COM	3/COL	4	5	6	7	L7	L8
N87LALAR	L-Spine	\$	1250	1331	1369	1425	1488	1600	1744	2433	2654
N87LSALAR	L-Spine with Seat		2500	2610	2663	2740	2826	2980	3177	4122	4425

DIMENSIONS

Width	40¾	Seat Height	16	Cubic Ft.	45
Depth	40¾			Cubic Ft. with Single Seat	45
Height	27¾				

- Contrasting fabric option - specify X (i.e. N87LALARX): see below. For list pricing, use your electronic specification tool or contact customer service
- Worksurfaces can be added to any spine in the field
- Ganging brackets are included with each spine
- Ganging brackets serve as wire management
- Grommet cutout option CUT-4G32 is available

120° SPINE

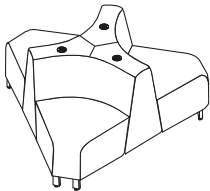
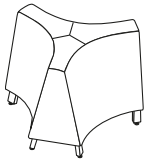

120° Spine with Seats shown with grommet option

			1	2/COM	3/COL	4	5	6	7	L7	L8
N87C120	120° Spine	\$	1650	1717	1749	1795	1847	1940	2059	2630	2813
N87CS120	120° Spine with Seats		4050	4177	4237	4325	4424	4600	4826	5909	6256

DIMENSIONS

Width	38¾	Seat Height	16	Cubic Ft.	24
Depth	33¾			Cubic Ft. with Single Seat	32
Depth with Seat	47				
Height	27¾				

- Contrasting fabric option - specify X (i.e. N87C120X): see below. For list pricing, use your electronic specification tool or contact customer service
- Worksurfaces can be added to any spine in the field
- Ganging brackets are included with each spine
- Ganging brackets serve as wire management
- Grommet cutout option CUT-3G32 is available

TO ORDER CONTRASTING FABRIC, SPECIFY:

1. Model Number plus "X"
2. Back Fabric Grade Number/Cover Number
3. Back Accent Fabric Grade Number/Cover Number
4. Upholstery Fabric Grade Number/Cover Number
5. Seat Fabric Grade Number/Cover Number (when applicable)
6. Extreme Fabric Grade Number/Cover Number (when applicable)
7. Grommet
8. Leg
9. Glide

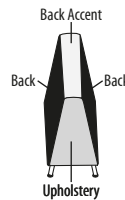

• Extreme location not available

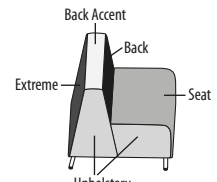

• Extreme location not available on two seat model

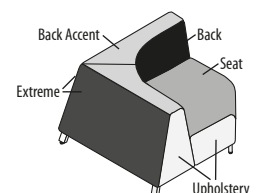
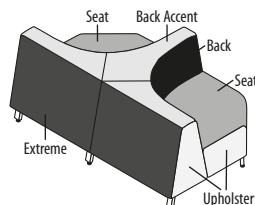

**BENCHES
TO ORDER, SPECIFY:**

1. Model Number
 2. Fabric Grade / Cover Number
 3. Leg Paint Color
 4. Caster/Glide
- See page 3A for Kozmic options

**WORKSURFACES
TO ORDER, SPECIFY:**

1. Model Number
 2. Rim Profile / Color (when applicable)
 3. Grommet
 4. Laminate Color
- See page 3A for Kozmic options

IMPROMPTU - BENCH

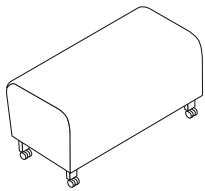

Mobile

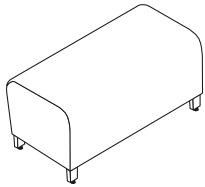

Static

**MODEL
NO.**

GRADE / LIST PRICE

		1	2/COM	3/COL	4	5	6	7	L7	L8
N87IN3616C	Mobile, 16"	\$ 1065	1105	1125	1153	1184	1240	1312	1657	1767
N87IN3616G	Static, 16"	1040	1080	1100	1128	1159	1215	1287	1632	1742
N87IN3618C	Mobile, 18"	1110	1151	1171	1200	1232	1290	1364	1718	1832
N87IN3618G	Static, 18"	1085	1126	1146	1175	1207	1265	1339	1693	1807

16" DIMENSIONS

Width	36
Depth	17
Height	16
Cubic Ft.	8

18" DIMENSIONS

Width	36
Depth	17½
Height	18
Cubic Ft.	8

- Contrasting fabric option - specify X (i.e. N87IN3616CX); see below. For list pricing, use you electronic specification tool or contact customer service
- Add ½" to height for braking caster option
- 18" models recommended for use with seated height worksurfaces
- Braking casters are recommended for use on hard floors

IMPROMPTU - 120°

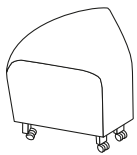

Mobile

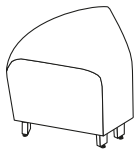

Static

		1	2/COM	3/COL	4	5	6	7	L7	L8
N87CR12016C	Mobile, 16"	\$ 850	882	898	920	945	990	1047	1323	1411
N87CR12016G	Static, 16"	800	832	848	870	895	940	997	1273	1361
N87CR12018C	Mobile, 18"	880	912	928	950	975	1020	1077	1353	1441
N87CR12018G	Static, 18"	830	862	878	900	925	970	1027	1303	1391

16" DIMENSIONS

Width	24½
Depth	19
Height	16
Cubic Ft.	6

18" DIMENSIONS

Width	25½
Depth	19¼
Height	18
Cubic Ft.	6

- Contrasting fabric option - specify X (i.e. N87CR12016CX); see below. For list pricing, use you electronic specification tool or contact customer service
- Add ½" to height for braking caster option
- 18" models recommended for use with seated height worksurfaces
- Braking casters are recommended for use on hard floors

TO ORDER CONTRASTING FABRIC, SPECIFY:

1. Model Number plus "X"
2. Seat Fabric Grade Number/Cover Number (when applicable)
3. Upholstery Fabric Grade Number/Cover Number
4. Leg Paint Color
5. Caster/Glide

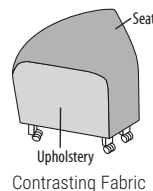

RECTANGULAR WORKSURFACES

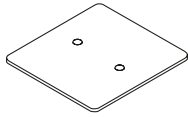

36x38 shown with grommet option

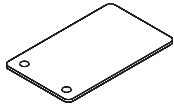

29x48 shown with grommet option

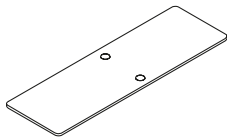

29x96 shown with grommet option

MODEL NO.		LIST PRICE	WIDTH	LENGTH	CUBIC FEET
N87TRT3638L	36x38 - PVC Softened Rim	\$ 675	36	38	2.8
N87TRT2948L	29x48 - PVC Softened Rim	675	29	48	2.0
N87TRT2996L	29x96 - PVC Softened Rim	950	29	96	4.0
N87TRT3638DL	36x38 - PVC Exposed Plywood Rim	\$ 675	36	38	2.8
N87TRT2948DL	29x48 - PVC Exposed Plywood Rim	675	29	48	2.0
N87TRT2996DL	29x96 - PVC Exposed Plywood Rim	950	29	96	4.0

- Grommet cutout option CUT-2G32 available
- Worksurface attachment will deface spine
- 29x48 must be used with two legs
- 29x96 must be used with four legs; used to span across spine, provides a worksurface for users on each side
- N87TRT2948D and N87TRT2996DL worksurface includes undersurface support rail
- N87TRT3638L Grommet location - 9" from edge 19" to center
- N87TRT2948L Grommet location - 5½" from side edge and 2" from top edge
- N87TRT2996L Grommet location - 5½" from side edge and 46" to center

WORKSURFACE EXTENSION

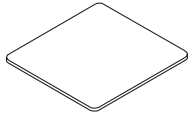

N87TRTE3638L	36x38 - PVC Softened Rim	\$ 575	36	38	2.8
N87TRTE3638DL	36x38 - PVC Exposed Plywood Rim	575	36	38	2.8

- Grommet cutout option not available
- Can only be used as an extension off the 120° surface
- Must be supported by two legs

120° WORKSURFACE

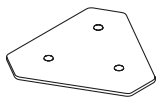

Shown with grommet option

N87TRD120L	120° - PVC Softened Rim	\$ 850			2.0
N87TRD120DL	120° - PVC Exposed Plywood Rim	850			2.0

- Grommet cutout option CUT-3G32 available
- Worksurface attachment will deface spine
- For use only with 120° spine
- N87TRD120L Grommet location - 9" from edge

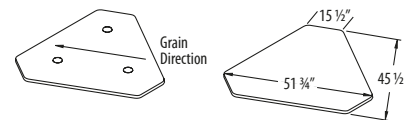

WEDGE WORKSURFACE

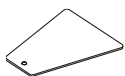

Shown with grommet option CUT-1G32

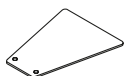

Shown with grommet option CUT-2G32

N87TWG4860L	Wedge - PVC Softened Rim	\$ 1075			6.2
N87TWG4860DL	Wedge - PVC Exposed Plywood Rim	1075			6.2

- Grommet cutout option CUT-1G32 or CUT-2G32 available
- Worksurface attachment will deface spine
- Must be supported by two legs
- Grommet cutout option CUT-1G32 is for attachment of the worksurface off the end of a spine
- Grommet cutout option CUT-2G32 is for attachment of the worksurface off the side of a spine
- Worksurface includes undersurface support rail
- Grommet CUT-1G32 is 9" from attachment edge
- Grommet CUT-2G32 is 2" from attachment edge

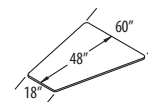

TO ORDER, SPECIFY:

1. Model Number
 2. Laminate Color (when applicable)
- See page 3A for Kozmic options

BISTRO TABLE

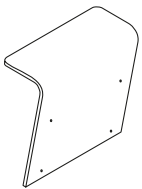

MODEL NO.	LIST PRICE	WIDTH	HEIGHT	CUBIC FEET
N87TSH36L	\$ 1700	36	44½	14

- Grommet cutout option not available
- Worksurface attachment will deface spine
- Exposed plywood edge, always clear
- Bistro table can be attached to any L or T spines (with or without integrated seating)
- When attaching a bistro table to an inline spine, the following must apply:
 - Spine with bistro table is ganged to an L, T or 120° spine (with or without integrated seating) or;
 - Bistro table is attached to an inline spine with integrated seating
- Attachment hardware in black and silver included
- Worksurface height is 44½" from top of surface to the floor

RECTANGULAR TABLE LEGS



CBV0228RTB	Black, 1 per Package	\$ 130		0.8
CBV0228RTS	Platinum Metallic, 1 per Package	130		0.8
CBV0228RTN	Satin Nickel Metallic, 1 per Package	130		0.8

- Specify model number only
- Legs can be attached to worksurface at different angles

POWER ENTRY

N87ELPE1	Electrical Power Entry (Hardwire) + 4WC	\$ 130	Circuit 2	0.5
N87ELPE48	48" Electrical Power Entry (20 amp Plug) + 4WC	190	Circuit 1	0.5
N87ELPE72	72" Electrical power entry (20 amp plug) + 4WC	215	Circuit 1	0.5

- Specify model number only
- Must be ordered with power or USB grommet and electrical kits
- One power entry is necessary to power one or multiple units

ELECTRICAL KITS

MODEL NO.		LIST PRICE	CUBIC FEET
N87ELKT1	1 H-Block, 42" Jumper Male / Male End	\$ 90	0.5
N87ELKT2	2 - H-Block 1 - 42" Jumper Male / Male End 1 - 36" Jumper Male / Male End	170	0.5
N87ELKT3	3 - H-Block 2 - 42" Jumper Male / Male End 1 - 36" Jumper Male / Male End	240	0.5

- Specify model number only
- Use specification guide below to determine necessary power or pass thru kits for each unit

ELECTRICAL KIT SPECIFICATION GUIDE

COMPONENT	FOR POWER OPTION, SPECIFY:	FOR PASS THRU OPTION (NON-POWER UNITS), SPECIFY:
Inline Spine	N87ELKT1	N87ELKT1
120 Spine	N87ELKT2	N87ELKT1
L-Spine	N87ELKT2	N87ELKT2
T-Spine	N87ELKT3	N87ELKT3

POWER GROMMET

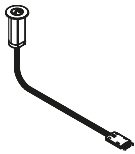

NACG32P1ELW	Circuit 1, White	\$ 150	0.5
NACG32P1ELB	Circuit 1, Black	150	0.5
NACG32P1ELG	Circuit 1, Light Grey	150	0.5
NACG32P1ELD	Circuit 1, Dark Grey	150	0.5
NACG32P2ELW	Circuit 2, White	\$ 150	0.5
NACG32P2ELB	Circuit 2, Black	150	0.5
NACG32P2ELG	Circuit 2, Light Grey	150	0.5
NACG32P2ELD	Circuit 2, Dark Grey	150	0.5

- Specify model number only
- Must use with power entry and electrical kits
- Features one power outlet
- Circuit 1 option allows 26 power grommets to be linked together
- Circuit 2 option allows 52 power grommets to be linked together

USB GROMMET

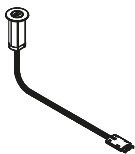

NACG32U1ELW	Circuit 1, White	\$ 240	0.5
NACG32U1ELB	Circuit 1, Black	240	0.5
NACG32U1ELG	Circuit 1, Light Grey	240	0.5
NACG32U1ELD	Circuit 1, Dark Grey	240	0.5
NACG32U2ELW	Circuit 2, White	\$ 240	0.5
NACG32U2ELB	Circuit 2, Black	240	0.5
NACG32U2ELG	Circuit 2, Light Grey	240	0.5
NACG32U2ELD	Circuit 2, Dark Grey	240	0.5

- Specify model number only
- Must use with power entry and electrical kits
- Features two USB ports
- Circuit 1 option allows 26 power grommets to be linked together
- Circuit 2 option allows 52 power grommets to be linked together

TO ORDER, SPECIFY:

1. Model Number

GANGING BRACKET

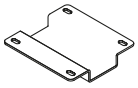

MODEL NO.

LIST PRICE

CUBIC FEET

MODEL NO.		LIST PRICE	CUBIC FEET
N87BR1	Ganging Bracket Kit	\$ 32	0.05

- Serves as wire management
- All spine units include necessary ganging brackets
- Only need to order ganging brackets if extra brackets are wanted or need replacement brackets

Final Model/Part	Contrasting location	Non Directional or Solid	1-4" Repeat	5-11" Repeat	12-18" Repeat	Leather	
N87AAA36		2.10		2.50	3.90	3.25	41.51
N87AAA36X	Back	1.50		1.80	2.10	2.25	28.50
	Back Accent	1.10		1.20	1.20	1.50	21.03
	Upholstery	0.75		1.00	1.20	1.30	15.00
N87C120		2.75		3.20	3.90	5.00	51.47
N87C120X	Back	2.25		2.50	3.20	3.50	43.50
	Back Accent	0.75		0.80	1.75	1.75	11.50
	Upholstery	0.75		1.10	2.20	2.20	15.50
N87TA		4.00		3.00	4.00	6.90	79.00
N87TAX	Back	1.30		1.80	2.40	2.40	30.99
	Back Accent	1.20		1.30	2.40	2.40	22.50
	Upholstery	0.75		1.10	2.31	2.30	15.50
	Extreme	1.50		1.80	2.40	2.40	29.00
N87LALAR		3.00		3.80	4.50	4.80	59.00
N87LALARX	Back	1.00		1.10	1.20	1.80	17.50
	Back Accent	1.10		1.30	1.80	1.90	21.50
	Upholstery	0.75		1.00	1.70	1.70	15.50
	Extreme	1.50		1.80	2.20	2.30	28.50
N87AS1A36		3.00		3.70	5.00	5.20	58.50
N87AS1A36X	Back	0.75		1.00	1.20	1.30	14.50
	Back Accent	1.10		1.20	1.20	1.50	21.03
	Upholstery	0.75		1.00	1.70	1.80	15.00
	Extreme	0.50		1.00	1.20	1.30	14.50
	Seat	1.25		1.40	1.80	2.00	24.50
N87AS2A36		4.50		5.30	6.20	6.70	87.50
N87AS2A36X	Back	1.50		1.80	2.10	2.25	28.50
	Back Accent	1.10		1.20	1.20	1.50	21.03
	Upholstery	1.10		1.40	2.60	2.80	21.50
	Seat	3.00		3.50	3.80	5.20	60.50
N87CS120		4.10		5.00	8.00	9.50	81.50
N87CS120X	Back	2.20		2.50	3.40	3.50	43.50
	Back Accent	0.60		0.80	1.75	1.75	11.50
	Upholstery	1.50		2.00	3.80	3.80	29.50
	Seat	2.10		2.80	5.20	5.20	41.51
N87TSA		6.20		5.40	6.30	8.30	123.00
N87TSAX	Back	1.30		1.80	2.40	2.40	30.99
	Back Accent	1.20		1.30	2.40	2.40	22.50
	Upholstery	0.75		1.10	2.30	2.40	15.50
	Extreme	1.50		1.80	2.40	2.40	29.00
	Seat	2.30		2.50	2.80	2.90	46.49
N87LSALAR		4.00		4.60	5.50	5.25	78.03
N87LSALARX	Back	1.00		1.10	1.20	1.80	17.50
	Back Accent	1.10		1.30	1.80	1.90	22.00
	Upholstery	1.50		1.70	2.40	2.40	29.00
	Extreme	1.50		1.80	2.20	2.30	28.50
	Seat	1.20		1.40	1.70	1.70	24.00
N87IN3616C, N87IN3616G		1.50		0.6	2.4	2.66	30.00
N87IN3616CX, N87IN3616GX		Upholstery		0.40	0.7	0.9	8.00
		Seat		1.20	1.5	1.8	23.50
N87IN3618C, N87IN3618G		1.75		2	2.4	3.3	34.50
N87IN3618CX, N87IN3618GX		Upholstery		0.50	0.7	0.9	9.50
		Seat		1.40	1.5	1.9	26.01
N87CR12016C, N87CR12016CG		1.00		1.5	1.8	2.75	19.50
N87CR12016CX, N87CR12016GX		Upholstery		0.40	0.7	0.9	8.00
		Seat		1.00	1.1	1.8	18.50
N87CR12018C, N87CR12018G		1.25		1.6	2.1	2.75	25.00
N87CR12018CX, N87CR12018GX		Upholstery		0.50	0.7	0.9	9.50
		Seat		1.00	1.1	2	19.50

